



TikZ

&

PGF

LATEX

BEX

Manual for Version 2.00-CVS

MANUAL FOR VERSION 2.00-CVS

```
\begin{tikzpicture}
\coordinate (front) at (0,0);
\coordinate (horizon) at (0,.31\paperheight);
\coordinate (bottom) at (0,-.6\paperheight);
\coordinate (sky) at (0,.57\paperheight);
\coordinate (left) at (-.51\paperwidth,0);
\coordinate (right) at (.51\paperwidth,0);

\shade [bottom color=white,
        top color=blue!30!black!50]
        ([yshift=-5mm]horizon -| left)
        rectangle (sky -| right);

\shade [bottom color=black!70!green!25,
        top color=black!70!green!10]
        (front -| left) -- (horizon -| left)
        decorate [decoration=random steps] {
        -- (horizon -| right) }
        -- (front -| right) -- cycle;

\shade [top color=black!70!green!25,
        bottom color=black!25]
        ([yshift=-5mm-1pt]front -| left)
        rectangle ([yshift=1pt]front -| right);

\fill [black!25]
        (bottom -| left)
        rectangle ([yshift=-5mm]front -| right);

\def\nodeshadowed[#1]#2;{
\global\setbox\mybox=\hbox{#2}
\copy\mybox;
\node[scale=2,above,#1,yscale=-1,
scope fading=south,opacity=0.4]{\box\mybox};
}
```

```
\nodeshadowed [at={{(-5,8 )}},yslant=0.05]
{\Huge Ti\textcolor{orange}{\emph{k}}Z};
\nodeshadowed [at={{( 0,8,3)}}]
{\huge \textcolor{green!50!black!50}{\&}};
\nodeshadowed [at={{( 5,8 )}},yslant=-0.05]
{\Huge \textsc{PGF}};
\nodeshadowed [at={{( 0,5 )}}]
{Manual for Version \pgftypesetversion};

\foreach \where in {-9cm,9cm} {
\nodeshadowed [at={{(\where,5cm)}}] { \tikz
\draw [green!20!black, rotate=90,
l-system={rule set={F -> FF-[-F+F]+[+F-F]},
axiom=F, order=4,step=2pt,
randomize step percent=50, angle=30,
randomize angle percent=5}] l-system; }}

\foreach \i in {0.5,0.6,...,2}
\fill
[white,opacity=\i/2,
decoration=Koch snowflake,
shift=(horizon),shift={{(rand*11,rnd*7)}},
scale=\i,double copy shadow={
opacity=0.2,shadow xshift=0pt,
shadow yshift=3*\i pt,fill=white,draw=none}]
decorate {
decorate {
decorate {
(0,0)- ++(60:1) -- ++(-60:1) -- cycle
} } };

\node (left text) ...
\node (right text) ...

\fill [decorate,decoration={footprints,foot of=gnome},
opacity=.5,brown] (rand*8,-rnd*10)
to [out=rand*180,in=rand*180] (rand*8,-rnd*10);
\end{tikzpicture}
```

Für meinen Vater, damit er noch viele schöne T<sub>E</sub>X-Graphiken erschaffen kann.

*Till*

Copyright 2007 by Till Tantau

Permission is granted to copy, distribute and/or modify *the documentation* under the terms of the GNU Free Documentation License, Version 1.2 or any later version published by the Free Software Foundation; with no Invariant Sections, no Front-Cover Texts, and no Back-Cover Texts. A copy of the license is included in the section entitled GNU Free Documentation License.

Permission is granted to copy, distribute and/or modify *the code of the package* under the terms of the GNU Public License, Version 2 or any later version published by the Free Software Foundation. A copy of the license is included in the section entitled GNU Public License.

Permission is also granted to distribute and/or modify *both the documentation and the code* under the conditions of the LaTeX Project Public License, either version 1.3 of this license or (at your option) any later version. A copy of the license is included in the section entitled L<sup>A</sup>T<sub>E</sub>X Project Public License.

# The TikZ and PGF Packages

## Manual for version 2.00-cvs

<http://sourceforge.net/projects/pgf>

Till Tantau\*

Institut für Theoretische Informatik  
Universität zu Lübeck

April 20, 2009

## Contents

<b>1</b>	<b>Introduction</b>	<b>19</b>
1.1	Structure of the System . . . . .	19
1.2	Comparison with Other Graphics Packages . . . . .	20
1.3	Utility Packages . . . . .	20
1.4	How to Read This Manual . . . . .	21
1.5	Authors and Acknowledgements . . . . .	21
1.6	Getting Help . . . . .	21
<b>I</b>	<b>Tutorials and Guidelines</b>	<b>22</b>
<b>2</b>	<b>Tutorial: A Picture for Karl's Students</b>	<b>23</b>
2.1	Problem Statement . . . . .	23
2.2	Setting up the Environment . . . . .	23
	2.2.1 Setting up the Environment in L <sup>A</sup> T <sub>E</sub> X . . . . .	23
	2.2.2 Setting up the Environment in Plain T <sub>E</sub> X . . . . .	24
	2.2.3 Setting up the Environment in ConT <sub>E</sub> Xt . . . . .	24
2.3	Straight Path Construction . . . . .	25
2.4	Curved Path Construction . . . . .	25
2.5	Circle Path Construction . . . . .	26
2.6	Rectangle Path Construction . . . . .	26
2.7	Grid Path Construction . . . . .	27
2.8	Adding a Touch of Style . . . . .	27
2.9	Drawing Options . . . . .	28
2.10	Arc Path Construction . . . . .	28
2.11	Clipping a Path . . . . .	29
2.12	Parabola and Sine Path Construction . . . . .	30
2.13	Filling and Drawing . . . . .	30
2.14	Shading . . . . .	31
2.15	Specifying Coordinates . . . . .	31
2.16	Intersecting Paths . . . . .	32
2.17	Adding Arrow Tips . . . . .	33
2.18	Scoping . . . . .	34
2.19	Transformations . . . . .	34
2.20	Repeating Things: For-Loops . . . . .	35
2.21	Adding Text . . . . .	36

---

\*Editor of this documentation. Parts of this documentation have been written by other authors as indicated in these parts or chapters and in Section 1.5.

<b>3</b>	<b>Tutorial: A Petri-Net for Hagen</b>	<b>40</b>
3.1	Problem Statement	40
3.2	Setting up the Environment	40
3.2.1	Setting up the Environment in $\text{\LaTeX}$	40
3.2.2	Setting up the Environment in Plain $\text{\TeX}$	40
3.2.3	Setting up the Environment in $\text{\ConTeXt}$	41
3.3	Introduction to Nodes	41
3.4	Placing Nodes Using the At Syntax	42
3.5	Using Styles	42
3.6	Node Size	43
3.7	Naming Nodes	43
3.8	Placing Nodes Using Relative Placement	44
3.9	Adding Labels Next to Nodes	44
3.10	Connecting Nodes	45
3.11	Adding Labels Next to Lines	47
3.12	Adding the Snaked Line and Multi-Line Text	48
3.13	Using Layers: The Background Rectangles	49
3.14	The Complete Code	49
<b>4</b>	<b>Tutorial: Euclid's Amber Version of the <i>Elements</i></b>	<b>51</b>
4.1	Book I, Proposition I	51
4.1.1	Setting up the Environment	51
4.1.2	The Line $AB$	52
4.1.3	The Circle Around $A$	52
4.1.4	The Intersection of the Circles	54
4.1.5	The Complete Code	55
4.2	Book I, Proposition II	56
4.2.1	Using Partway Calculations for the Construction of $D$	56
4.2.2	Intersecting a Line and a Circle	57
4.2.3	The Complete Code	58
<b>5</b>	<b>Tutorial: Putting a Diagram in Chains</b>	<b>59</b>
5.1	Styling the Nodes	59
5.2	Aligning the Nodes Using Positioning Options	61
5.3	Aligning the Nodes Using Matrices	63
5.4	Using Chains	64
5.4.1	Creating a Simple Chain	64
5.4.2	Branching and Joining a Chain	65
5.4.3	Chaining Together Already Positioned Nodes	66
5.4.4	Combined Use of Matrices and Chains	67
<b>6</b>	<b>Tutorial: A Lecture Map for Johannes</b>	<b>68</b>
6.1	Problem Statement	68
6.2	Introduction to Trees	68
6.3	Creating the Lecture Map	71
6.4	Adding the Lecture Annotations	75
6.5	Adding the Background	76
6.6	Adding the Calendar	77
6.7	The Complete Code	79
<b>7</b>	<b>Guidelines on Graphics</b>	<b>83</b>
7.1	Planning the Time Needed for the Creation of Graphics	83
7.2	Workflow for Creating a Graphic	83
7.3	Linking Graphics With the Main Text	84
7.4	Consistency Between Graphics and Text	84
7.5	Labels in Graphics	85
7.6	Plots and Charts	85
7.7	Attention and Distraction	88

<b>II</b>	<b>Installation and Configuration</b>	<b>90</b>
<b>8</b>	<b>Installation</b>	<b>91</b>
8.1	Package and Driver Versions . . . . .	91
8.2	Installing Prebundled Packages . . . . .	91
8.2.1	Debian . . . . .	91
8.2.2	MiKTeX . . . . .	91
8.3	Installation in a texmf Tree . . . . .	92
8.3.1	Installation that Keeps Everything Together . . . . .	92
8.3.2	Installation that is TDS-Compliant . . . . .	92
8.4	Updating the Installation . . . . .	92
<b>9</b>	<b>Licenses and Copyright</b>	<b>93</b>
9.1	Which License Applies? . . . . .	93
9.2	The GNU Public License, Version 2 . . . . .	93
9.2.1	Preamble . . . . .	93
9.2.2	Terms and Conditions For Copying, Distribution and Modification . . . . .	94
9.2.3	No Warranty . . . . .	96
9.3	The L <sup>A</sup> T <sub>E</sub> X Project Public License, Version 1.3c 2006-05-20 . . . . .	96
9.3.1	Preamble . . . . .	96
9.3.2	Definitions . . . . .	96
9.3.3	Conditions on Distribution and Modification . . . . .	97
9.3.4	No Warranty . . . . .	98
9.3.5	Maintenance of The Work . . . . .	99
9.3.6	Whether and How to Distribute Works under This License . . . . .	99
9.3.7	Choosing This License or Another License . . . . .	99
9.3.8	A Recommendation on Modification Without Distribution . . . . .	100
9.3.9	How to Use This License . . . . .	100
9.3.10	Derived Works That Are Not Replacements . . . . .	100
9.3.11	Important Recommendations . . . . .	100
9.4	GNU Free Documentation License, Version 1.2, November 2002 . . . . .	101
9.4.1	Preamble . . . . .	101
9.4.2	Applicability and definitions . . . . .	101
9.4.3	Verbatim Copying . . . . .	102
9.4.4	Copying in Quantity . . . . .	102
9.4.5	Modifications . . . . .	102
9.4.6	Combining Documents . . . . .	104
9.4.7	Collection of Documents . . . . .	104
9.4.8	Aggregating with independent Works . . . . .	104
9.4.9	Translation . . . . .	104
9.4.10	Termination . . . . .	104
9.4.11	Future Revisions of this License . . . . .	105
9.4.12	Addendum: How to use this License for your documents . . . . .	105
<b>10</b>	<b>Input and Output Formats</b>	<b>106</b>
10.1	Supported Input Formats . . . . .	106
10.1.1	Using the L <sup>A</sup> T <sub>E</sub> X Format . . . . .	106
10.1.2	Using the Plain T <sub>E</sub> X Format . . . . .	106
10.1.3	Using the ConT <sub>E</sub> Xt Format . . . . .	106
10.2	Supported Output Formats . . . . .	107
10.2.1	Selecting the Backend Driver . . . . .	107
10.2.2	Producing PDF Output . . . . .	107
10.2.3	Producing PostScript Output . . . . .	108
10.2.4	Producing HTML / SVG Output . . . . .	109
10.2.5	Producing Perfectly Portable DVI Output . . . . .	110
<b>III</b>	<b>TikZ ist <i>kein</i> Zeichenprogramm</b>	<b>111</b>

<b>11 Design Principles</b>	<b>112</b>
11.1 Special Syntax For Specifying Points . . . . .	112
11.2 Special Syntax For Path Specifications . . . . .	112
11.3 Actions on Paths . . . . .	112
11.4 Key-Value Syntax for Graphic Parameters . . . . .	113
11.5 Special Syntax for Specifying Nodes . . . . .	113
11.6 Special Syntax for Specifying Trees . . . . .	113
11.7 Grouping of Graphic Parameters . . . . .	114
11.8 Coordinate Transformation System . . . . .	114
<b>12 Hierarchical Structures: Package, Environments, Scopes, and Styles</b>	<b>115</b>
12.1 Loading the Package and the Libraries . . . . .	115
12.2 Creating a Picture . . . . .	115
12.2.1 Creating a Picture Using an Environment . . . . .	115
12.2.2 Creating a Picture Using a Command . . . . .	117
12.2.3 Adding a Background . . . . .	117
12.3 Using Scopes to Structure a Picture . . . . .	118
12.3.1 The Scope Environment . . . . .	118
12.3.2 Shorthand for Scope Environments . . . . .	118
12.3.3 Using Scopes Inside Paths . . . . .	119
12.4 Using Graphic Options . . . . .	119
12.4.1 How Graphic Options Are Processed . . . . .	119
12.4.2 Using Styles to Manage How Pictures Look . . . . .	120
<b>13 Specifying Coordinates</b>	<b>122</b>
13.1 Overview . . . . .	122
13.2 Coordinate Systems . . . . .	122
13.2.1 Canvas, XYZ, and Polar Coordinate Systems . . . . .	122
13.2.2 Barycentric Systems . . . . .	125
13.2.3 Node Coordinate System . . . . .	126
13.2.4 Tangent Coordinate Systems . . . . .	128
13.2.5 Defining New Coordinate Systems . . . . .	129
13.3 Coordinates at Intersections . . . . .	129
13.3.1 Intersections of Perpendicular Lines . . . . .	129
13.3.2 Intersections of Arbitrary Paths . . . . .	130
13.4 Relative and Incremental Coordinates . . . . .	132
13.4.1 Specifying Relative Coordinates . . . . .	132
13.4.2 Relative Coordinates and Scopes . . . . .	132
13.5 Coordinate Calculations . . . . .	133
13.5.1 The General Syntax . . . . .	133
13.5.2 The Syntax of Factors . . . . .	134
13.5.3 The Syntax of Partway Modifiers . . . . .	134
13.5.4 The Syntax of Distance Modifiers . . . . .	135
13.5.5 The Syntax of Projection Modifiers . . . . .	136
<b>14 Syntax for Path Specifications</b>	<b>137</b>
14.1 The Move-To Operation . . . . .	138
14.2 The Line-To Operation . . . . .	139
14.2.1 Straight Lines . . . . .	139
14.2.2 Horizontal and Vertical Lines . . . . .	139
14.3 The Curve-To Operation . . . . .	139
14.4 The Cycle Operation . . . . .	140
14.5 The Rectangle Operation . . . . .	140
14.6 Rounding Corners . . . . .	140
14.7 The Circle and Ellipse Operations . . . . .	141
14.8 The Arc Operation . . . . .	143
14.9 The Grid Operation . . . . .	143
14.10 The Parabola Operation . . . . .	145
14.11 The Sine and Cosine Operation . . . . .	146

14.12	The SVG Operation . . . . .	146
14.13	The Plot Operation . . . . .	147
14.14	The To Path Operation . . . . .	147
14.15	The Let Operation . . . . .	149
14.16	The Scoping Operation . . . . .	151
14.17	The Node and Edge Operations . . . . .	151
14.18	The PGF-Extra Operation . . . . .	151
<b>15</b>	<b>Actions on Paths</b>	<b>153</b>
15.1	Overview . . . . .	153
15.2	Specifying a Color . . . . .	154
15.3	Drawing a Path . . . . .	154
15.3.1	Graphic Parameters: Line Width, Line Cap, and Line Join . . . . .	155
15.3.2	Graphic Parameters: Dash Pattern . . . . .	156
15.3.3	Graphic Parameters: Draw Opacity . . . . .	157
15.3.4	Graphic Parameters: Arrow Tips . . . . .	157
15.3.5	Graphic Parameters: Double Lines and Bordered Lines . . . . .	159
15.4	Filling a Path . . . . .	160
15.4.1	Graphic Parameters: Fill Pattern . . . . .	160
15.4.2	Graphic Parameters: Interior Rules . . . . .	161
15.4.3	Graphic Parameters: Fill Opacity . . . . .	162
15.5	Generalized Filling: Using Arbitrary Pictures to Fill a Path . . . . .	162
15.6	Shading a Path . . . . .	163
15.7	Establishing a Bounding Box . . . . .	164
15.8	Clipping and Fading (Soft Clipping) . . . . .	165
15.9	Doing Multiple Actions on a Path . . . . .	166
15.10	Decorating and Morphing a Path . . . . .	168
<b>16</b>	<b>Nodes and Edges</b>	<b>170</b>
16.1	Overview . . . . .	170
16.2	Nodes and Their Shapes . . . . .	170
16.2.1	Predefined Shapes . . . . .	172
16.2.2	Common Options: Separations, Margins, Padding and Border Rotation . . . . .	172
16.3	Multi-Part Nodes . . . . .	175
16.4	The Node Text . . . . .	176
16.4.1	Text Parameters: Color and Opacity . . . . .	176
16.4.2	Text Parameters: Font . . . . .	176
16.4.3	Text Parameters: Alignment and Width for Multi-Line Text . . . . .	176
16.4.4	Text Parameters: Height and Depth of Text . . . . .	180
16.5	Positioning Nodes . . . . .	180
16.5.1	Positioning Nodes Using Anchors . . . . .	180
16.5.2	Basic Placement Options . . . . .	181
16.5.3	Advanced Placement Options . . . . .	182
16.5.4	Arranging Nodes Using a Chains and Matrices . . . . .	186
16.6	Fitting Nodes to a Set of Coordinates . . . . .	186
16.7	Transformations . . . . .	187
16.8	Placing Nodes on a Line or Curve Explicitly . . . . .	187
16.9	Placing Nodes on a Line or Curve Implicitly . . . . .	190
16.10	The Label and Pin Options . . . . .	191
16.11	Connecting Nodes: Using Nodes as Coordinates . . . . .	194
16.12	Connecting Nodes: Using the Edge Operation . . . . .	194
16.13	Referencing Nodes Outside the Current Pictures . . . . .	196
16.13.1	Referencing a Node in a Different Picture . . . . .	196
16.13.2	Referencing the Current Page Node – Absolute Positioning . . . . .	197
16.14	Late Code and Late Options . . . . .	197

<b>17 Matrices and Alignment</b>	<b>199</b>
17.1 Overview	199
17.2 Matrices are Nodes	199
17.3 Cell Pictures	200
17.3.1 Alignment of Cell Pictures	200
17.3.2 Setting and Adjusting Column and Row Spacing	201
17.3.3 Cell Styles and Options	203
17.4 Anchoring a Matrix	205
17.5 Considerations Concerning Active Characters	206
17.6 Examples	206
<b>18 Making Trees Grow</b>	<b>210</b>
18.1 Introduction to the Child Operation	210
18.2 Child Paths and the Child Nodes	211
18.3 Naming Child Nodes	211
18.4 Specifying Options for Trees and Children	212
18.5 Placing Child Nodes	213
18.5.1 Basic Idea	213
18.5.2 Default Growth Function	214
18.5.3 Missing Children	216
18.5.4 Custom Growth Functions	217
18.6 Edges From the Parent Node	218
<b>19 Plots of Functions</b>	<b>220</b>
19.1 When Should One Use TikZ for Generating Plots?	220
19.2 The Plot Path Operation	220
19.3 Plotting Points Given Inline	221
19.4 Plotting Points Read From an External File	221
19.5 Plotting a Function	221
19.6 Plotting a Function Using Gnuplot	223
19.7 Placing Marks on the Plot	225
19.8 Smooth Plots, Sharp Plots, Jump Plots, Comb Plots and Bar Plots	226
<b>20 Transparency</b>	<b>231</b>
20.1 Overview	231
20.2 Specifying a Uniform Opacity	231
20.3 Fadings	233
20.3.1 Creating Fadings	233
20.3.2 Fading a Path	235
20.3.3 Fading a Scope	237
20.4 Transparency Groups	237
<b>21 Decorated Paths</b>	<b>239</b>
21.1 Overview	239
21.2 Decorating a Subpath Using the Decorate Path Command	241
21.3 Decorating a Complete Path	242
21.4 Adjusting Decorations	243
21.4.1 Positioning Decorations Relative to the To-Be-Decorate Path	243
21.4.2 Starting and Ending Decorations Early or Late	244
<b>22 Transformations</b>	<b>246</b>
22.1 The Different Coordinate Systems	246
22.2 The XY- and XYZ-Coordinate Systems	246
22.3 Coordinate Transformations	247
22.4 Canvas Transformations	250
<b>IV Libraries</b>	<b>252</b>



<b>23 Arrow Tip Library</b>	<b>253</b>
23.1 Mathematical Arrow Tips . . . . .	253
23.2 Triangular Arrow Tips . . . . .	253
23.3 Barbed Arrow Tips . . . . .	253
23.4 Bracket-Like Arrow Tips . . . . .	254
23.5 Circle, Diamond and Square Arrow Tips . . . . .	254
23.6 Serif-Like Arrow Tips . . . . .	254
23.7 Partial Arrow Tips . . . . .	254
23.8 Line Caps . . . . .	254
23.9 Spacing Tips . . . . .	254
<b>24 Automata Drawing Library</b>	<b>255</b>
24.1 Drawing Automata . . . . .	255
24.2 States With and Without Output . . . . .	256
24.3 Initial and Accepting States . . . . .	256
24.4 Examples . . . . .	258
<b>25 Background Library</b>	<b>260</b>
<b>26 Calendar Library</b>	<b>263</b>
26.1 Calendar Command . . . . .	263
26.1.1 Creating a Simple List of Days . . . . .	270
26.1.2 Adding a Month Label . . . . .	270
26.1.3 Creating a Week List Arrangement . . . . .	270
26.1.4 Creating a Month List Arrangement . . . . .	271
26.2 Arrangements . . . . .	271
26.3 Month Labels . . . . .	273
26.4 Examples . . . . .	276
<b>27 Chains</b>	<b>280</b>
27.1 Overview . . . . .	280
27.2 Starting and Continuing a Chain . . . . .	280
27.3 Nodes on a Chain . . . . .	281
27.4 Joining Nodes on a Chain . . . . .	284
27.5 Branches . . . . .	284
<b>28 Circuit Libraries</b>	<b>286</b>
28.1 Introduction . . . . .	286
28.1.1 A First Example . . . . .	286
28.1.2 Symbols . . . . .	287
28.1.3 Symbol Graphics . . . . .	287
28.1.4 Annotations . . . . .	288
28.2 The Base Circuit Library . . . . .	288
28.2.1 Symbol Size . . . . .	289
28.2.2 Declaring New Symbols . . . . .	289
28.2.3 Pointing Symbols in the Right Direction . . . . .	291
28.2.4 Info Labels . . . . .	292
28.2.5 Declaring and Using Annotations . . . . .	293
28.2.6 Theming Symbols . . . . .	294
28.3 Logical Circuits . . . . .	296
28.3.1 Overview . . . . .	296
28.3.2 Symbols: The Gates . . . . .	298
28.3.3 Implementation: The Logic Gates Shape Library . . . . .	299
28.3.4 Implementation: The US-Style Logic Gates Shape Library . . . . .	300
28.3.5 Implementation: The IEC-Style Logic Gates Shape Library . . . . .	302
28.4 Electrical Engineering Circuits . . . . .	304
28.4.1 Overview . . . . .	304
28.4.2 Symbols: Indicating Current Directions . . . . .	307
28.4.3 Symbols: Basic Elements . . . . .	307

28.4.4	Symbols: Diodes . . . . .	307
28.4.5	Symbols: Contacts . . . . .	308
28.4.6	Units . . . . .	308
28.4.7	Annotations . . . . .	308
28.4.8	Implementation: The EE-Symbols Shape Library . . . . .	308
28.4.9	Implementation: The IEC-Style EE-Symbols Shape Library . . . . .	310
<b>29</b>	<b>Decoration Library</b>	<b>316</b>
29.1	Overview and Common Options . . . . .	316
29.2	Path Morphing Decorations . . . . .	317
29.2.1	Decorations Producing Straight Line Paths . . . . .	317
29.2.2	Decorations Producing Curved Line Paths . . . . .	318
29.3	Path Replacing Decorations . . . . .	320
29.4	Marking Decorations . . . . .	323
29.4.1	Overview . . . . .	323
29.5	Arbitrary Markings . . . . .	323
29.5.1	Arrow Tip Markings . . . . .	327
29.5.2	Footprint Markings . . . . .	328
29.5.3	Shape Background Markings . . . . .	329
29.6	Text Decorations . . . . .	333
29.7	Fractal Decorations . . . . .	335
<b>30</b>	<b>Entity-Relationship Diagram Drawing Library</b>	<b>337</b>
30.1	Entities . . . . .	337
30.2	Relationships . . . . .	337
30.3	Attributes . . . . .	338
<b>31</b>	<b>Externalization Library</b>	<b>339</b>
31.1	Overview . . . . .	339
31.2	Requirements . . . . .	339
31.3	A word about ConTeXt and plain TeX . . . . .	339
31.4	Externalizing graphics . . . . .	339
31.4.1	Customizing the Generated File Names . . . . .	341
31.4.2	Remaking Figures or Skipping Figures . . . . .	343
31.4.3	Customizing the Externalization . . . . .	343
31.5	Using external graphics without PGF installed . . . . .	346
31.6	Externalization and bounding box restrictions . . . . .	347
31.7	eps Graphics . . . . .	347
31.8	Interoperability with the basic layer externalization . . . . .	347
<b>32</b>	<b>Fading Library</b>	<b>348</b>
<b>33</b>	<b>Fitting Library</b>	<b>349</b>
<b>34</b>	<b>Fixed Point Arithmetic Library</b>	<b>352</b>
34.1	Overview . . . . .	352
34.2	Using Fixed Point Arithmetic in PGF and TikZ . . . . .	352
<b>35</b>	<b>Floating Point Unit Library</b>	<b>354</b>
35.1	Overview . . . . .	354
35.2	Usage . . . . .	354
35.3	Comparison to the fixed point arithmetics library . . . . .	355
35.4	Command Reference and Programmer's Manual . . . . .	355
35.4.1	Float-specific commands . . . . .	355
35.4.2	Replacement commands . . . . .	360
35.4.3	Accessing the Original Math Routines for Programmers . . . . .	361

<b>36 Lindenmayer System Drawing Library</b>	<b>362</b>
36.1 Overview . . . . .	362
36.1.1 Declaring L-systems . . . . .	362
36.2 Using Lindenmayer Systems . . . . .	364
36.2.1 Using L-Systems in PGF . . . . .	364
36.2.2 Using L-Systems in TikZ . . . . .	365
<b>37 Matrix Library</b>	<b>367</b>
37.1 Matrices of Nodes . . . . .	367
37.2 End-of-Lines and End-of-Row Characters in Matrices of Nodes . . . . .	368
37.3 Delimiters . . . . .	369
<b>38 Mindmap Drawing Library</b>	<b>371</b>
38.1 Overview . . . . .	371
38.2 The Mindmap Style . . . . .	371
38.3 Concepts Nodes . . . . .	372
38.3.1 Isolated Concepts . . . . .	372
38.3.2 Concepts in Trees . . . . .	373
38.4 Connecting Concepts . . . . .	375
38.4.1 Simple Connections . . . . .	375
38.4.2 The Circle Connection Bar Decoration . . . . .	376
38.4.3 The Circle Connection Bar To-Path . . . . .	377
38.4.4 Tree Edges . . . . .	378
38.5 Adding Annotations . . . . .	379
<b>39 Paper Folding Diagrams Library</b>	<b>380</b>
<b>40 Pattern Library</b>	<b>384</b>
40.1 Form-Only Patterns . . . . .	384
40.2 Inherently Colored Patterns . . . . .	384
<b>41 Petri-Net Drawing Library</b>	<b>385</b>
41.1 Places . . . . .	385
41.2 Transitions . . . . .	385
41.3 Tokens . . . . .	386
41.4 Examples . . . . .	388
<b>42 Plot Handler Library</b>	<b>390</b>
42.1 Curve Plot Handlers . . . . .	390
42.2 Constant Plot Handlers . . . . .	391
42.3 Comb Plot Handlers . . . . .	392
42.4 Bar Plot Handlers . . . . .	393
42.5 Mark Plot Handler . . . . .	395
<b>43 Plot Mark Library</b>	<b>398</b>
<b>44 Shadings Library</b>	<b>399</b>
<b>45 Shadow Library</b>	<b>402</b>
45.1 Overview . . . . .	402
45.2 The General Shadow Option . . . . .	402
45.3 Shadows for Arbitrary Paths and Shapes . . . . .	403
45.3.1 Drop Shadows . . . . .	403
45.3.2 Copy Shadows . . . . .	403
45.4 Shadows for Special Paths and Nodes . . . . .	404

<b>46 Shape Library</b>	<b>406</b>
46.1 Overview . . . . .	406
46.2 Predefined Shapes . . . . .	406
46.3 Geometric Shapes . . . . .	407
46.4 Symbol Shapes . . . . .	422
46.5 Arrow Shapes . . . . .	429
46.6 Shapes with Multiple Text Parts . . . . .	435
46.7 Callout Shapes . . . . .	441
46.8 Miscellaneous Shapes . . . . .	445
<b>47 SVG-Path Library</b>	<b>451</b>
<b>48 To Path Library</b>	<b>452</b>
48.1 Straight Lines . . . . .	452
48.2 Move-Tos . . . . .	452
48.3 Curves . . . . .	452
48.4 Loops . . . . .	455
<b>49 Through Library</b>	<b>457</b>
<b>50 Tree Library</b>	<b>458</b>
50.1 Growth Functions . . . . .	458
50.2 Edges From Parent . . . . .	460
<b>51 Turtle Graphics Library</b>	<b>461</b>
<b>V Data Visualization</b>	<b>463</b>
<b>52 Introduction to Data Visualization</b>	<b>464</b>
52.1 Concept: Data Points . . . . .	464
52.2 Concept: Visualization Pipeline . . . . .	464
<b>53 Creating a Data Visualization</b>	<b>466</b>
53.1 Overview . . . . .	466
53.2 Concepts . . . . .	466
53.3 Usage (TikZ) . . . . .	466
53.4 Reference: . . . . .	466
53.5 Advanced: Data Visualization Objects . . . . .	466
<b>54 Providing Data for a Data Visualization</b>	<b>467</b>
54.1 Overview . . . . .	467
54.2 Concepts . . . . .	467
54.3 Reference: Standard Formats . . . . .	467
54.4 Advanced: The Data Parsing Process . . . . .	470
54.5 Advanced: Defining New Formats . . . . .	471
<b>VI Utilities</b>	<b>476</b>
<b>55 Key Management</b>	<b>477</b>
55.1 Introduction . . . . .	477
55.1.1 Comparison to Other Packages . . . . .	477
55.1.2 Quick Guide to Using the Key Mechanism . . . . .	477
55.2 The Key Tree . . . . .	478
55.3 Setting Keys . . . . .	479
55.3.1 Default Arguments . . . . .	480
55.3.2 Keys That Execute Commands . . . . .	481
55.3.3 Keys That Store Values . . . . .	482
55.3.4 Keys That Are Handled . . . . .	482

55.3.5	Keys That Are Unknown . . . . .	484
55.3.6	Search Paths And Handled Keys . . . . .	484
55.4	Key Handlers . . . . .	485
55.4.1	Handlers for Path Management . . . . .	485
55.4.2	Setting Defaults . . . . .	487
55.4.3	Defining Key Codes . . . . .	487
55.4.4	Defining Styles . . . . .	489
55.4.5	Defining Value-, Macro-, If- and Choice-Keys . . . . .	490
55.4.6	Expanding Values . . . . .	491
55.4.7	Handlers for Testing Keys . . . . .	492
55.4.8	Handlers for Key Inspection . . . . .	492
55.5	Error Keys . . . . .	493
55.6	Key filtering . . . . .	493
55.6.1	Starting with an example . . . . .	493
55.6.2	Setting filters . . . . .	494
55.6.3	Handlers for unprocessed keys . . . . .	495
55.6.4	Family support . . . . .	496
55.6.5	Other key filters . . . . .	497
55.6.6	Programmer Interface . . . . .	498
55.6.7	Defining own filters or filter handlers . . . . .	499
<b>56</b>	<b>Repeating Things: The Foreach Statement</b>	<b>500</b>
<b>57</b>	<b>Date and Calendar Utility Macros</b>	<b>505</b>
57.1	Handling Dates . . . . .	505
57.1.1	Conversions Between Date Types . . . . .	505
57.1.2	Checking Dates . . . . .	506
57.1.3	Typesetting Dates . . . . .	507
57.1.4	Localization . . . . .	508
57.2	Typesetting Calendars . . . . .	508
<b>58</b>	<b>Page Management</b>	<b>511</b>
58.1	Basic Usage . . . . .	511
58.2	The Predefined Layouts . . . . .	512
58.3	Defining a Layout . . . . .	514
58.4	Creating Logical Pages . . . . .	517
<b>59</b>	<b>Extended Color Support</b>	<b>518</b>
<b>60</b>	<b>Parser Module</b>	<b>519</b>
<b>VII</b>	<b>Mathematical and Object-Oriented Engines</b>	<b>520</b>
<b>61</b>	<b>Design Principles</b>	<b>521</b>
61.1	Loading the Mathematical Engine . . . . .	521
61.2	Layers of the Mathematical Engine . . . . .	521
61.3	Efficiency and Accuracy of the Mathematical Engine . . . . .	521
<b>62</b>	<b>Evaluating Mathematical Expressions</b>	<b>522</b>
62.1	Commands for Parsing Expressions . . . . .	522
<b>63</b>	<b>Syntax for mathematical expressions</b>	<b>523</b>
63.1	Operators . . . . .	523
63.2	Functions . . . . .	525
63.2.1	Basic arithmetic functions . . . . .	526
63.2.2	Rounding functions . . . . .	528
63.2.3	Trigonometric functions . . . . .	529
63.2.4	Comparison and logical functions . . . . .	530
63.2.5	Pseudo-random functions . . . . .	532

63.2.6	Base conversion functions . . . . .	532
63.2.7	Miscellaneous functions . . . . .	533
<b>64</b>	<b>Additional Mathematical Commands</b>	<b>535</b>
64.1	Basic arithmetic functions . . . . .	535
64.2	Comparison and logical functions . . . . .	535
64.3	Pseudo-Random Numbers . . . . .	535
64.4	Base Conversion . . . . .	536
<b>65</b>	<b>Customising the Mathematical Engine</b>	<b>537</b>
<b>66</b>	<b>Number Printing</b>	<b>539</b>
66.1	Changing display styles . . . . .	541
<b>67</b>	<b>Object-Oriented Programming</b>	<b>545</b>
67.1	Overview . . . . .	545
67.2	A Running Example: The Stamp Class . . . . .	545
67.3	Classes . . . . .	545
67.4	Objects . . . . .	546
67.5	Methods . . . . .	547
67.6	Attributes . . . . .	548
67.7	Identities . . . . .	550
67.8	The Signal Class . . . . .	551
67.9	Implementation Notes . . . . .	552
<b>VIII</b>	<b>The Basic Layer</b>	<b>553</b>
<b>68</b>	<b>Design Principles</b>	<b>554</b>
68.1	Core and Modules . . . . .	554
68.2	Communicating with the Basic Layer via Macros . . . . .	554
68.3	Path-Centered Approach . . . . .	555
68.4	Coordinate Versus Canvas Transformations . . . . .	555
<b>69</b>	<b>Hierarchical Structures: Package, Environments, Scopes, and Text</b>	<b>556</b>
69.1	Overview . . . . .	556
69.1.1	The Hierarchical Structure of the Package . . . . .	556
69.1.2	The Hierarchical Structure of Graphics . . . . .	556
69.2	The Hierarchical Structure of the Package . . . . .	557
69.2.1	The Core Package . . . . .	557
69.2.2	The Modules . . . . .	558
69.2.3	The Library Packages . . . . .	558
69.3	The Hierarchical Structure of the Graphics . . . . .	558
69.3.1	The Main Environment . . . . .	558
69.3.2	Graphic Scope Environments . . . . .	560
69.3.3	Inserting Text and Images . . . . .	563
<b>70</b>	<b>Specifying Coordinates</b>	<b>565</b>
70.1	Overview . . . . .	565
70.2	Basic Coordinate Commands . . . . .	565
70.3	Coordinates in the XY-Coordinate System . . . . .	565
70.4	Three Dimensional Coordinates . . . . .	566
70.5	Building Coordinates From Other Coordinates . . . . .	567
70.5.1	Basic Manipulations of Coordinates . . . . .	567
70.5.2	Points Traveling along Lines and Curves . . . . .	568
70.5.3	Points on Borders of Objects . . . . .	569
70.5.4	Points on the Intersection of Lines . . . . .	570
70.5.5	Points on the Intersection of Two Circles . . . . .	570
70.5.6	Points on the Intersection of Two Paths . . . . .	570
70.6	Extracting Coordinates . . . . .	571

70.7	Internals of How Point Commands Work . . . . .	571
<b>71</b>	<b>Constructing Paths</b>	<b>573</b>
71.1	Overview . . . . .	573
71.2	The Move-To Path Operation . . . . .	573
71.3	The Line-To Path Operation . . . . .	574
71.4	The Curve-To Path Operations . . . . .	574
71.5	The Close Path Operation . . . . .	575
71.6	Arc, Ellipse and Circle Path Operations . . . . .	575
71.7	Rectangle Path Operations . . . . .	578
71.8	The Grid Path Operation . . . . .	578
71.9	The Parabola Path Operation . . . . .	579
71.10	Sine and Cosine Path Operations . . . . .	579
71.11	Plot Path Operations . . . . .	580
71.12	Rounded Corners . . . . .	580
71.13	Internal Tracking of Bounding Boxes for Paths and Pictures . . . . .	581
<b>72</b>	<b>Decorations</b>	<b>583</b>
72.1	Overview . . . . .	583
72.2	Decoration Automata . . . . .	583
	72.2.1 The Different Paths . . . . .	583
	72.2.2 Segments and States . . . . .	584
72.3	Declaring Decorations . . . . .	585
	72.3.1 Predefined Decorations . . . . .	589
72.4	Using Decorations . . . . .	589
72.5	Meta-Decorations . . . . .	592
	72.5.1 Declaring Meta-Decorations . . . . .	593
	72.5.2 Predefined Meta-decorations . . . . .	594
	72.5.3 Using Meta-Decorations . . . . .	594
<b>73</b>	<b>Using Paths</b>	<b>596</b>
73.1	Overview . . . . .	596
73.2	Stroking a Path . . . . .	597
	73.2.1 Graphic Parameter: Line Width . . . . .	597
	73.2.2 Graphic Parameter: Caps and Joins . . . . .	597
	73.2.3 Graphic Parameter: Dashing . . . . .	597
	73.2.4 Graphic Parameter: Stroke Color . . . . .	598
	73.2.5 Graphic Parameter: Stroke Opacity . . . . .	598
	73.2.6 Graphic Parameter: Arrows . . . . .	598
	73.2.7 Inner Lines . . . . .	599
73.3	Filling a Path . . . . .	600
	73.3.1 Graphic Parameter: Interior Rule . . . . .	600
	73.3.2 Graphic Parameter: Filling Color . . . . .	601
	73.3.3 Graphic Parameter: Fill Opacity . . . . .	601
73.4	Clipping a Path . . . . .	601
73.5	Using a Path as a Bounding Box . . . . .	601
<b>74</b>	<b>Arrow Tips</b>	<b>602</b>
74.1	Overview . . . . .	602
	74.1.1 When Does PGF Draw Arrow Tips? . . . . .	602
	74.1.2 Meta-Arrow Tips . . . . .	602
74.2	Declaring an Arrow Tip Kind . . . . .	603
74.3	Declaring a Derived Arrow Tip Kind . . . . .	607
74.4	Using an Arrow Tip Kind . . . . .	608
74.5	Predefined Arrow Tip Kinds . . . . .	609



<b>75 Nodes and Shapes</b>	<b>610</b>
75.1 Overview	610
75.1.1 Creating and Referencing Nodes	610
75.1.2 Anchors	610
75.1.3 Layers of a Shape	610
75.1.4 Node Parts	611
75.2 Creating Nodes	611
75.3 Using Anchors	614
75.3.1 Referencing Anchors of Nodes in the Same Picture	614
75.3.2 Referencing Anchors of Nodes in Different Pictures	615
75.4 Special Nodes	615
75.5 Declaring New Shapes	616
75.5.1 What Must Be Defined For a Shape?	616
75.5.2 Normal Anchors Versus Saved Anchors	617
75.5.3 Command for Declaring New Shapes	617
<b>76 Matrices</b>	<b>623</b>
76.1 Overview	623
76.2 Cell Pictures and Their Alignment	623
76.3 The Matrix Command	623
76.4 Row and Column Spacing	625
76.5 Callbacks	627
<b>77 Coordinate and Canvas Transformations</b>	<b>628</b>
77.1 Overview	628
77.2 Coordinate Transformations	628
77.2.1 How PGF Keeps Track of the Coordinate Transformation Matrix	628
77.2.2 Commands for Relative Coordinate Transformations	628
77.2.3 Commands for Absolute Coordinate Transformations	632
77.2.4 Saving and Restoring the Coordinate Transformation Matrix	633
77.3 Canvas Transformations	633
<b>78 Patterns</b>	<b>635</b>
78.1 Overview	635
78.2 Declaring a Pattern	635
78.3 Setting a Pattern	637
<b>79 Declaring and Using Images</b>	<b>638</b>
79.1 Overview	638
79.2 Declaring an Image	638
79.3 Using an Image	639
79.4 Masking an Image	640
<b>80 Externalizing Graphics</b>	<b>642</b>
80.1 Overview	642
80.2 Workflow Step 1: Naming Graphics	642
80.3 Workflow Step 2: Generating the External Graphics	643
80.4 Workflow Step 3: Including the External Graphics	644
80.5 A Complete Example	645
<b>81 Creating Plots</b>	<b>649</b>
81.1 Overview	649
81.2 Generating Plot Streams	649
81.2.1 Basic Building Blocks of Plot Streams	649
81.2.2 Commands That Generate Plot Streams	650
81.3 Plot Handlers	651



<b>82 Layered Graphics</b>	<b>653</b>
82.1 Overview . . . . .	653
82.2 Declaring Layers . . . . .	653
82.3 Using Layers . . . . .	653
<b>83 Shadings</b>	<b>655</b>
83.1 Overview . . . . .	655
83.2 Declaring Shadings . . . . .	655
83.2.1 Horizontal and Vertical Shadings . . . . .	655
83.2.2 Radial Shadings . . . . .	656
83.2.3 General (Functional) Shadings . . . . .	656
83.3 Using Shadings . . . . .	658
<b>84 Transparency</b>	<b>662</b>
84.1 Specifying a Uniform Opacity . . . . .	662
84.2 Specifying a Fading . . . . .	662
84.3 Transparency Groups . . . . .	664
<b>85 Adding libraries to pgf: temporary registers</b>	<b>666</b>
<b>86 Quick Commands</b>	<b>668</b>
86.1 Quick Coordinate Commands . . . . .	668
86.2 Quick Path Construction Commands . . . . .	668
86.3 Quick Path Usage Commands . . . . .	669
86.4 Quick Text Box Commands . . . . .	669
<b>IX The System Layer</b>	<b>670</b>
<b>87 Design of the System Layer</b>	<b>671</b>
87.1 Driver Files . . . . .	671
87.2 Common Definition Files . . . . .	671
<b>88 Commands of the System Layer</b>	<b>672</b>
88.1 Beginning and Ending a Stream of System Commands . . . . .	672
88.2 Path Construction System Commands . . . . .	673
88.3 Canvas Transformation System Commands . . . . .	674
88.4 Stroking, Filling, and Clipping System Commands . . . . .	674
88.5 Graphic State Option System Commands . . . . .	675
88.6 Color System Commands . . . . .	676
88.7 Pattern System Commands . . . . .	678
88.8 Scoping System Commands . . . . .	678
88.9 Image System Commands . . . . .	679
88.10 Shading System Commands . . . . .	679
88.11 Transparency System Commands . . . . .	680
88.12 Reusable Objects System Commands . . . . .	680
88.13 Invisibility System Commands . . . . .	681
88.14 Position Tracking Commands . . . . .	681
88.15 Internal Conversion Commands . . . . .	682
<b>89 The Soft Path Subsystem</b>	<b>683</b>
89.1 Path Creation Process . . . . .	683
89.2 Starting and Ending a Soft Path . . . . .	683
89.3 Soft Path Creation Commands . . . . .	684
89.4 The Soft Path Data Structure . . . . .	684
<b>90 The Protocol Subsystem</b>	<b>686</b>
<b>X References and Index</b>	<b>687</b>

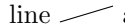

# 1 Introduction

The PGF package, where “PGF” is supposed to mean “portable graphics format” (or “pretty, good, functional” if you prefer...), is a package for creating graphics in an “inline” manner. It defines a number of  $\TeX$  commands that draw graphics. For example, the code `\tikz \draw (0pt,0pt) -- (20pt,6pt);` yields the line  and the code `\tikz \fill[orange] (1ex,1ex) circle (1ex);` yields .

In a sense, when you use PGF you “program” your graphics, just as you “program” your document when you use  $\TeX$ . You get all the advantages of the “ $\TeX$ -approach to typesetting” for your graphics: quick creation of simple graphics, precise positioning, the use of macros, often superior typography. You also inherit all the disadvantages: steep learning curve, no WYSIWYG, small changes require a long recompilation time, and the code does not really “show” how things will look like.

## 1.1 Structure of the System

The PGF system consists of different layers:

**System layer:** This layer provides a complete abstraction of what is going on “in the driver.” The driver is a program like `dvips` or `dvipdfm` that takes a `.dvi` file as input and generates a `.ps` or a `.pdf` file. (The `pdftex` program also counts as a driver, even though it does not take a `.dvi` file as input. Never mind.) Each driver has its own syntax for the generation of graphics, causing headaches to everyone who wants to create graphics in a portable way. PGF’s system layer “abstracts away” these differences. For example, the system command `\pgfsys@lineto{10pt}{10pt}` extends the current path to the coordinate (10pt,10pt) of the current `{pgfpicture}`. Depending on whether `dvips`, `dvipdfm`, or `pdftex` is used to process the document, the system command will be converted to different `\special` commands. The system layer is as “minimalistic” as possible since each additional command makes it more work to port PGF to a new driver.

As a user, you will not use the system layer directly.

**Basic layer:** The basic layer provides a set of basic commands that allow you to produce complex graphics in a much easier manner than by using the system layer directly. For example, the system layer provides no commands for creating circles since circles can be composed from the more basic Bézier curves (well, almost). However, as a user you will want to have a simple command to create circles (at least I do) instead of having to write down half a page of Bézier curve support coordinates. Thus, the basic layer provides a command `\pgfpathcircle` that generates the necessary curve coordinates for you.

The basic layer is consists of a *core*, which consists of several interdependent packages that can only be loaded *en bloc*, and additional *modules* that extend the core by more special-purpose commands like node management or a plotting interface. For instance, the BEAMER package uses only the core and not, say, the `shapes` modules.

**Frontend layer:** A frontend (of which there can be several) is a set of commands or a special syntax that makes using the basic layer easier. A problem with directly using the basic layer is that code written for this layer is often too “verbose.” For example, to draw a simple triangle, you may need as many as five commands when using the basic layer: One for beginning a path at the first corner of the triangle, one for extending the path to the second corner, one for going to the third, one for closing the path, and one for actually painting the triangle (as opposed to filling it). With the `tikz` frontend all this boils down to a single simple METAFONT-like command:

```
\draw (0,0) -- (1,0) -- (1,1) -- cycle;
```

There are different frontends:

- The `TikZ` frontend is the “natural” frontend for PGF. It gives you access to all features of PGF, but it is intended to be easy to use. The syntax is a mixture of METAFONT and PSTricks and some ideas of myself. This frontend is *neither* a complete METAFONT compatibility layer nor a PSTricks compatibility layer and it is not intended to become either.
- The `pgfpict2e` frontend reimplements the standard  $\LaTeX$  `{picture}` environment and commands like `\line` or `\vector` using the PGF basic layer. This layer is not really “necessary” since the `pict2e.sty` package does at least as good a job at reimplementing the `{picture}` environment. Rather, the idea behind this package is to have a simple demonstration of how a frontend can be implemented.

It would be possible to implement a `pgftricks` frontend that maps `PSTRICKS` commands to `PGF` commands. However, I have not done this and even if fully implemented, many things that work in `PSTRICKS` will not work, namely whenever some `PSTRICKS` command relies too heavily on PostScript trickery. Nevertheless, such a package might be useful in some situations.

As a user of `PGF` you will use the commands of a frontend plus perhaps some commands of the basic layer. For this reason, this manual explains the frontends first, then the basic layer, and finally the system layer.

## 1.2 Comparison with Other Graphics Packages

`PGF` is not the only graphics package for `TEX`. In the following, I try to give a reasonably fair comparison of the `PGF`-system and other packages.

1. The standard `LATEX` `{picture}` environment allows you to create simple graphics, but little more. This is certainly not due to a lack of knowledge or imagination on the part of `LATEX`'s designer(s). Rather, this is the price paid for the `{picture}` environment's portability: It works together with all backend drivers.
2. The `pstricks` package is certainly powerful enough to create any conceivable kind of graphic, but it is not portable at all. Most importantly, it does not work with `pdftex` nor with any other driver that produces anything but PostScript code.

Compared to `PGF`, `pstricks` has a broader support base. There are many nice extra packages for special purpose situations that have been contributed by users over the last decade.

The `TikZ` syntax is more consistent than the `pstricks` syntax as `TikZ` was developed “in a more centralized manner” and also “with the shortcomings on `pstricks` in mind.”

Note that a number of neat tricks that `pstricks` can do are impossible in `PGF`. In particular, `pstricks` has access to the powerful PostScript programming language, which allows trickery such as inline function plotting.

3. The `xypic` package is an older package for creating graphics. However, it is more difficult to use and to learn because the syntax and the documentation are a bit cryptic.
4. The `dratex` package is a small graphic package for creating a graphics. Compared to the other package, including `PGF`, it is very small, which may or may not be an advantage.
5. The `metapost` program is a very powerful alternative to `PGF`. However, it is an external program, which entails a bunch of problems. The time needed both to create a small graphic and also to compile it is much greater than in `PGF`. The main problem with `metapost`, however, is the inclusion of labels. This is *much* easier to achieve using `PGF`.
6. The `xfig` program is an important alternative to `TikZ` for users who do not wish to “program” their graphics as is necessary with `TikZ` and the other packages above. There is a conversion program that will convert `xfig` graphics to both `TikZ` and for `PGF`, but it is still under construction.

## 1.3 Utility Packages

The `PGF` package comes along with a number of utility packages that are not really about creating graphics and which can be used independently of `PGF`. However, they are bundled with `PGF`, partly out of convenience, partly because their functionality is closely intertwined with `PGF`. These utility packages are:

1. The `pgfkeys` package defines a powerful key management facility. It can be used completely independently of `PGF`.
2. The `pgffor` package defines a useful `\foreach` statement.
3. The `pgfcalendar` package defines macros for creating calendars. Typically, these calendars will be rendered using `PGF`'s graphic engine, but you can use `pgfcalendar` also typeset calendars using normal text. The package also defines commands for “working” with dates.

4. The `pgfpages` package is used to assemble several pages into a single page. It provides commands for assembling several “virtual pages” into a single “physical page.” The idea is that whenever  $\TeX$  has a page ready for “shipout,” `pgfpages` interrupts this shipout and instead stores the page to be shipped out in a special box. When enough “virtual pages” have been accumulated in this way, they are scaled down and arranged on a “physical page,” which then *really* shipped out. This mechanism allows you to create “two page on one page” versions of a document directly inside  $\LaTeX$  without the use of any external programs. However, `pgfpages` can do quite a lot more than that. You can use it to put logos and watermark on pages, print up to 16 pages on one page, add borders to pages, and more.

## 1.4 How to Read This Manual

This manual describes both the design of the PGF system and its usage. The organization is very roughly according to “user-friendliness.” The commands and subpackages that are easiest and most frequently used are described first, more low-level and esoteric features are discussed later.

If you have not yet installed PGF, please read the installation first. Second, it might be a good idea to read the tutorial. Finally, you might wish to skim through the description of `TikZ`. Typically, you will not need to read the sections on the basic layer. You will only need to read the part on the system layer if you intend to write your own frontend or if you wish to port PGF to a new driver.

The “public” commands and environments provided by the `pgf` package are described throughout the text. In each such description, the described command, environment or option is printed in red. Text shown in green is optional and can be left out.

## 1.5 Authors and Acknowledgements

The bulk of the PGF system and its documentation was written by Till Tantau. The PGF mathematical engine, many shapes, and the decoration engine were written and documented by Mark Wibrow. Additionally, numerous people have contributed to the PGF system by writing emails, spotting bugs, or sending libraries. Many thanks to all these people, who are too numerous to name them all!

## 1.6 Getting Help

When you need help with PGF and `TikZ`, please do the following:

1. Read the manual, at least the part that has to do with your problem.
2. If that does not solve the problem, try having a look at the sourceforge development page for PGF and `TikZ` (see the title of this document). Perhaps someone has already reported a similar problem and someone has found a solution.
3. On the website you will find numerous forums for getting help. There, you can write to help forums, file bug reports, join mailing lists, and so on.
4. Before you file a bug report, especially a bug report concerning the installation, make sure that this is really a bug. In particular, have a look at the `.log` file that results when you  $\TeX$  your files. This `.log` file should show that all the right files are loaded from the right directories. Nearly all installation problems can be resolved by looking at the `.log` file.
5. *As a last resort* you can try to email me (Till Tantau) or, if the problem concerns the mathematical engine, Mark Wibrow. I do not mind getting emails, I simply get way too many of them. Because of this, I cannot guarantee that your emails will be answered timely or even at all. Your chances that your problem will be fixed are somewhat higher if you mail to the PGF mailing list (naturally, I read this list and answer questions when I have the time).
6. Please, do not phone me in my office (unless, of course, you attend one of my lectures).

## Part I

# Tutorials and Guidelines

*by Till Tantau*

To help you get started with *TikZ*, instead of a long installation and configuration section, this manual starts with tutorials. They explain all the basic and some of the more advanced features of the system, without going into all the details. This part also contains some guidelines on how you should proceed when creating graphics using *TikZ*.

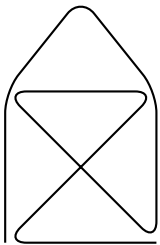

```
\tikz \draw[thick,rounded corners=8pt]
(0,0) -- (0,2) -- (1,3.25) -- (2,2) -- (2,0) -- (0,2) -- (2,2) -- (0,0) -- (2,0);
```

## 2 Tutorial: A Picture for Karl's Students

This tutorial is intended for new users of PGF and TikZ. It does not give an exhaustive account of all the features of TikZ or PGF, just of those that you are likely to use right away.

Karl is a math and chemistry high-school teacher. He used to create the graphics in his worksheets and exams using L<sup>A</sup>T<sub>E</sub>X's `{picture}` environment. While the results were acceptable, creating the graphics often turned out to be a lengthy process. Also, there tended to be problems with lines having slightly wrong angles and circles also seemed to be hard to get right. Naturally, his students could not care less whether the lines had the exact right angles and they find Karl's exams too difficult no matter how nicely they were drawn. But Karl was never entirely satisfied with the result.

Karl's son, who was even less satisfied with the results (he did not have to take the exams, after all), told Karl that he might wish to try out a new package for creating graphics. A bit confusingly, this package seems to have two names: First, Karl had to download and install a package called PGF. Then it turns out that inside this package there is another package called TikZ, which is supposed to stand for "TikZ ist *kein* Zeichenprogramm." Karl finds this all a bit strange and TikZ seems to indicate that the package does not do what he needs. However, having used GNU software for quite some time and "GNU not being Unix," there seems to be hope yet. His son assures him that TikZ's name is intended to warn people that TikZ is not a program that you can use to draw graphics with your mouse or tablet. Rather, it is more like a "graphics language."

### 2.1 Problem Statement

Karl wants to put a graphic on the next worksheet for his students. He is currently teaching his students about sine and cosine. What he would like to have is something that looks like this (ideally):

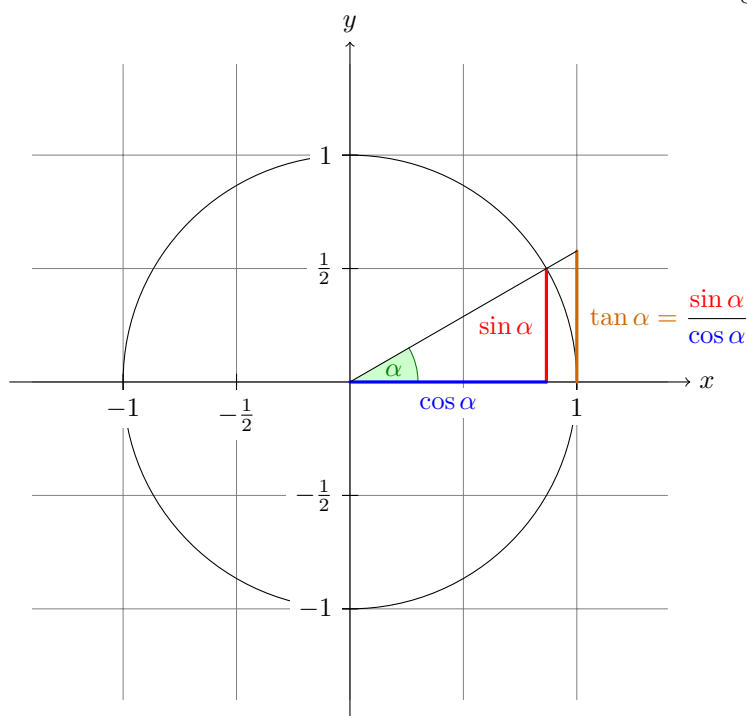

The angle  $\alpha$  is  $30^\circ$  in the example ( $\pi/6$  in radians). The sine of  $\alpha$ , which is the height of the red line, is

$$\sin \alpha = 1/2.$$

By the Theorem of Pythagoras we have  $\cos^2 \alpha + \sin^2 \alpha = 1$ . Thus the length of the blue line, which is the cosine of  $\alpha$ , must be

$$\cos \alpha = \sqrt{1 - 1/4} = \frac{1}{2}\sqrt{3}.$$

This shows that  $\tan \alpha$ , which is the height of the orange line, is

$$\tan \alpha = \frac{\sin \alpha}{\cos \alpha} = 1/\sqrt{3}.$$

### 2.2 Setting up the Environment

In TikZ, to draw a picture, at the start of the picture you need to tell T<sub>E</sub>X or L<sup>A</sup>T<sub>E</sub>X that you want to start a picture. In L<sup>A</sup>T<sub>E</sub>X this is done using the environment `{tikzpicture}`, in plain T<sub>E</sub>X you just use `\tikzpicture` to start the picture and `\endtikzpicture` to end it.

#### 2.2.1 Setting up the Environment in L<sup>A</sup>T<sub>E</sub>X

Karl, being a L<sup>A</sup>T<sub>E</sub>X user, thus sets up his file as follows:

```

\documentclass{article} % say
\usepackage{tikz}
\begin{document}
We are working on
\begin{tikzpicture}
  \draw (-1.5,0) -- (1.5,0);
  \draw (0,-1.5) -- (0,1.5);
\end{tikzpicture}.
\end{document}

```

When executed, that is, run via `pdflatex` or via `latex` followed by `dvips`, the resulting will contain something that looks like this:

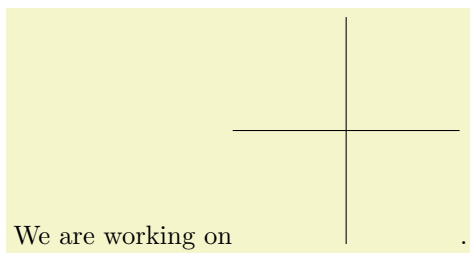

```

We are working on
\begin{tikzpicture}
  \draw (-1.5,0) -- (1.5,0);
  \draw (0,-1.5) -- (0,1.5);
\end{tikzpicture}.

```

Admittedly, not quite the whole picture, yet, but we do have the axes established. Well, not quite, but we have the lines that make up the axes drawn. Karl suddenly has a sinking feeling that the picture is still some way off.

Let's have a more detailed look at the code. First, the package `tikz` is loaded. This package is a so-called “frontend” to the basic PGF system. The basic layer, which is also described in this manual, is somewhat more, well, basic and thus harder to use. The frontend makes things easier by providing a simpler syntax.

Inside the environment there are two `\draw` commands. They mean: “The path, which is specified following the command up to the semicolon, should be drawn.” The first path is specified as `(-1.5,0) -- (0,1.5)`, which means “a straight line from the point at position  $(-1.5, 0)$  to the point at position  $(0, 1.5)$ .” Here, the positions are specified within a special coordinate system in which, initially, one unit is 1cm.

Karl is quite pleased to note that the environment automatically reserves enough space to encompass the picture.

### 2.2.2 Setting up the Environment in Plain TeX

Karl's wife Gerda, who also happens to be a math teacher, is not a  $\LaTeX$  user, but uses plain TeX since she prefers to do things “the old way.” She can also use TikZ. Instead of `\usepackage{tikz}` she has to write `\input tikz.tex` and instead of `\begin{tikzpicture}` she writes `\tikzpicture` and instead of `\end{tikzpicture}` she writes `\endtikzpicture`.

Thus, she would use:

```

%% Plain TeX file
\input tikz.tex
\baselineskip=12pt
\hsize=6.3truein
\vsize=8.7truein
We are working on
\tikzpicture
  \draw (-1.5,0) -- (1.5,0);
  \draw (0,-1.5) -- (0,1.5);
\endtikzpicture.
\bye

```

Gerda can typeset this file using either `pdftex` or `tex` together with `dvips`. TikZ will automatically discern which driver she is using. If she wishes to use `dvipdfm` together with `tex`, she either needs to modify the file `pgf.cfg` or can write `\def\pgfsysdriver{pgfsys-dvipdfm.def}` somewhere *before* she inputs `tikz.tex` or `pgf.tex`.

### 2.2.3 Setting up the Environment in ConTeXt

Karl's uncle Hans uses ConTeXt. Like Gerda, Hans can also use TikZ. Instead of `\usepackage{tikz}` he says `\usemodule[tikz]`. Instead of `\begin{tikzpicture}` he writes `\starttikzpicture` and instead of `\end{tikzpicture}` he writes `\stoptikzpicture`.



His version of the example looks like this:

```
% ConTeXt file
\usemodule[tikz]

\starttext
  We are working on
  \starttikzpicture
    \draw (-1.5,0) -- (1.5,0);
    \draw (0,-1.5) -- (0,1.5);
  \stoptikzpicture.
\stoptext
```

Hans will now typeset this file in the usual way using `texexec`.

## 2.3 Straight Path Construction

The basic building block of all pictures in TikZ is the path. A *path* is a series of straight lines and curves that are connected (that is not the whole picture, but let us ignore the complications for the moment). You start a path by specifying the coordinates of the start position as a point in round brackets, as in  $(0,0)$ . This is followed by a series of “path extension operations.” The simplest is `--`, which we used already. It must be followed by another coordinate and it extends the path in a straight line to this new position. For example, if we were to turn the two paths of the axes into one path, the following would result:

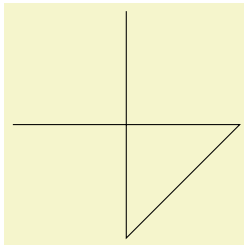

```
\tikz \draw (-1.5,0) -- (1.5,0) -- (0,-1.5) -- (0,1.5);
```

Karl is a bit confused by the fact that there is no `{tikzpicture}` environment, here. Instead, the little command `\tikz` is used. This command either takes one argument (starting with an opening brace as in `\tikz{\draw (0,0) -- (1.5,0)}`, which yields `—————`) or collects everything up to the next semicolon and puts it inside a `{tikzpicture}` environment. As a rule of thumb, all TikZ graphic drawing commands must occur as an argument of `\tikz` or inside a `{tikzpicture}` environment. Fortunately, the command `\draw` will only be defined inside this environment, so there is little chance that you will accidentally do something wrong here.

## 2.4 Curved Path Construction

The next thing Karl wants to do is to draw the circle. For this, straight lines obviously will not do. Instead, we need some way to draw curves. For this, TikZ provides a special syntax. One or two “control points” are needed. The math behind them is not quite trivial, but here is the basic idea: Suppose you are at point  $x$  and the first control point is  $y$ . Then the curve will start “going in the direction of  $y$  at  $x$ ,” that is, the tangent of the curve at  $x$  will point toward  $y$ . Next, suppose the curve should end at  $z$  and the second support point is  $w$ . Then the curve will, indeed, end at  $z$  and the tangent of the curve at point  $z$  will go through  $w$ .

Here is an example (the control points have been added for clarity):

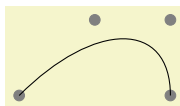

```
\begin{tikzpicture}
  \filldraw [gray] (0,0) circle (2pt)
    (1,1) circle (2pt)
    (2,1) circle (2pt)
    (2,0) circle (2pt);
  \draw (0,0) .. controls (1,1) and (2,1) .. (2,0);
\end{tikzpicture}
```

The general syntax for extending a path in a “curved” way is `.. controls  $\langle$ first control point $\rangle$  and  $\langle$ second control point $\rangle$  ..  $\langle$ end point $\rangle$` . You can leave out the `and  $\langle$ second control point $\rangle$` , which causes the first one to be used twice.

So, Karl can now add the first half circle to the picture:

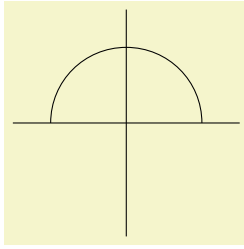

```
\begin{tikzpicture}
\draw (-1.5,0) -- (1.5,0);
\draw (0,-1.5) -- (0,1.5);
\draw (-1,0) .. controls (-1,0.555) and (-0.555,1) .. (0,1)
.. controls (0.555,1) and (1,0.555) .. (1,0);
\end{tikzpicture}
```

Karl is happy with the result, but finds specifying circles in this way to be extremely awkward. Fortunately, there is a much simpler way.

## 2.5 Circle Path Construction

In order to draw a circle, the path construction operation `circle` can be used. This operation is followed by a radius in round brackets as in the following example: (Note that the previous position is used as the *center* of the circle.)



```
\tikz \draw (0,0) circle (10pt);
```

You can also append an ellipse to the path using the `ellipse` operation. Instead of a single radius you can specify two of them, one for the *x*-direction and one for the *y*-direction, separated by `and`:

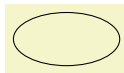

```
\tikz \draw (0,0) ellipse (20pt and 10pt);
```

To draw an ellipse whose axes are not horizontal and vertical, but point in an arbitrary direction (a “turned ellipse” like  $\mathcal{O}$ ) you can use transformations, which are explained later. The code for the little ellipse is `\tikz \draw[rotate=30] (0,0) ellipse (6pt and 3pt);`, by the way.

So, returning to Karl’s problem, he can write `\draw (0,0) circle (1cm);` to draw the circle:

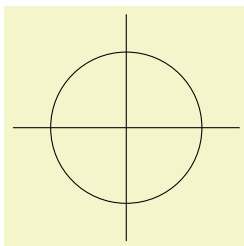

```
\begin{tikzpicture}
\draw (-1.5,0) -- (1.5,0);
\draw (0,-1.5) -- (0,1.5);
\draw (0,0) circle (1cm);
\end{tikzpicture}
```

At this point, Karl is a bit alarmed that the circle is so small when he wants the final picture to be much bigger. He is pleased to learn that *TikZ* has powerful transformation options and scaling everything by a factor of three is very easy. But let us leave the size as it is for the moment to save some space.

## 2.6 Rectangle Path Construction

The next things we would like to have is the grid in the background. There are several ways to produce it. For example, one might draw lots of rectangles. Since rectangles are so common, there is a special syntax for them: To add a rectangle to the current path, use the `rectangle` path construction operation. This operation should be followed by another coordinate and will append a rectangle to the path such that the previous coordinate and the next coordinates are corners of the rectangle. So, let us add two rectangles to the picture:

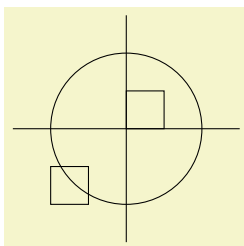

```
\begin{tikzpicture}
\draw (-1.5,0) -- (1.5,0);
\draw (0,-1.5) -- (0,1.5);
\draw (0,0) circle (1cm);
\draw (0,0) rectangle (0.5,0.5);
\draw (-0.5,-0.5) rectangle (-1,-1);
\end{tikzpicture}
```

While this may be nice in other situations, this is not really leading anywhere with Karl's problem: First, we would need an awful lot of these rectangles and then there is the border that is not "closed."

So, Karl is about to resort to simply drawing four vertical and four horizontal lines using the nice `\draw` command, when he learns that there is a `grid` path construction operation.

## 2.7 Grid Path Construction

The `grid` path operation adds a grid to the current path. It will add lines making up a grid that fills the rectangle whose one corner is the current point and whose other corner is the point following the `grid` operation. For example, the code `\tikz \draw[step=2pt] (0,0) grid (10pt,10pt);` produces . Note how the optional argument for `\draw` can be used to specify a grid width (there are also `xstep` and `ystep` to define the steppings independently). As Karl will learn soon, there are *lots* of things that can be influenced using such options.

For Karl, the following code could be used:

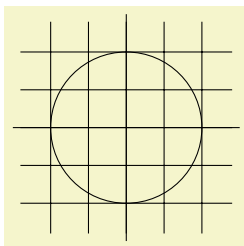

```
\begin{tikzpicture}
  \draw (-1.5,0) -- (1.5,0);
  \draw (0,-1.5) -- (0,1.5);
  \draw (0,0) circle (1cm);
  \draw[step=.5cm] (-1.4,-1.4) grid (1.4,1.4);
\end{tikzpicture}
```

Having another look at the desired picture, Karl notices that it would be nice for the grid to be more subdued. (His son told him that grids tend to be distracting if they are not subdued.) To subdue the grid, Karl adds two more options to the `\draw` command that draws the grid. First, he uses the color `gray` for the grid lines. Second, he reduces the line width to `very thin`. Finally, he swaps the ordering of the commands so that the grid is drawn first and everything else on top.

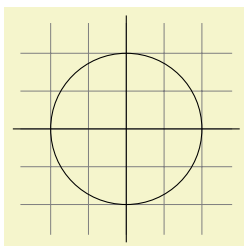

```
\begin{tikzpicture}
  \draw[step=.5cm,gray,very thin] (-1.4,-1.4) grid (1.4,1.4);
  \draw (-1.5,0) -- (1.5,0);
  \draw (0,-1.5) -- (0,1.5);
  \draw (0,0) circle (1cm);
\end{tikzpicture}
```

## 2.8 Adding a Touch of Style

Instead of the options `gray,very thin` Karl could also have said `help lines`. *Styles* are predefined sets of options that can be used to organize how a graphic is drawn. By saying `help lines` you say "use the style that I (or someone else) has set for drawing help lines." If Karl decides, at some later point, that grids should be drawn, say, using the color `blue!50` instead of `gray`, he could provide the following option somewhere:

```
help lines/.style={color=blue!50,very thin}
```

The effect of this "style setter" is that in the current scope or environment the `help lines` option has the same effect as `color=blue!50,very thin`.

Using styles makes your graphics code more flexible. You can change the way things look easily in a consistent manner. Normally, styles are defined at the beginning of a picture. However, you may sometimes wish to define a style globally, so that all pictures of your document can use this style. Then you can easily change the way all graphics look by changing this one style. In this situation you can use the `\tikzset` command at the beginning of the document as in

```
\tikzset{help lines/.style=very thin}
```

To build a hierarchy of styles you can have one style use another. So in order to define a style `Karl's grid` that is based on the `grid` style Karl could say

```
\tikzset{Karl's grid/.style={help lines,color=blue!50}}
...
\draw[Karl's grid] (0,0) grid (5,5);
```

Styles are made even more powerful by parametrization. This means that, like other options, styles can also be used with a parameter. For instance, Karl could parametrize his grid so that, by default, it is blue, but he could also use another color.

```
\begin{tikzpicture}
[Karl's grid/.style ={help lines,color=#1!50},
Karl's grid/.default=blue]

\draw[Karl's grid] (0,0) grid (1.5,2);
\draw[Karl's grid=red] (2,0) grid (3.5,2);
\end{tikzpicture}
```

## 2.9 Drawing Options

Karl wonders what other options there are that influence how a path is drawn. He saw already that the `color=color` option can be used to set the line's color. The option `draw=color` does nearly the same, only it sets the color for the lines only and a different color can be used for filling (Karl will need this when he fills the arc for the angle).

He saw that the style `very thin` yields very thin lines. Karl is not really surprised by this and neither is he surprised to learn that `thin` yields thin lines, `thick` yields thick lines, `very thick` yields very thick lines, `ultra thick` yields really, really thick lines and `ultra thin` yields lines that are so thin that low-resolution printers and displays will have trouble showing them. He wonders what gives lines of “normal” thickness. It turns out that `thin` is the correct choice. This seems strange to Karl, but his son explains him that L<sup>A</sup>T<sub>E</sub>X has two commands called `\thinlines` and `\thicklines` and that `\thinlines` gives the line width of “normal” lines, more precisely, of the thickness that, say, the stem of a letter like “T” or “i” has. Nevertheless, Karl would like to know whether there is anything “in the middle” between `thin` and `thick`. There is: `semithick`.

Another useful thing one can do with lines is to dash or dot them. For this, the two styles `dashed` and `dotted` can be used, yielding `--` and `.....`. Both options also exist in a loose and a dense version, called `loosely dashed`, `densely dashed`, `loosely dotted`, and `densely dotted`. If he really, really needs to, Karl can also define much more complex dashing patterns with the `dash pattern` option, but his son insists that dashing is to be used with utmost care and mostly distracts. Karl's son claims that complicated dashing patterns are evil. Karl's students do not care about dashing patterns.

## 2.10 Arc Path Construction

Our next obstacle is to draw the arc for the angle. For this, the `arc` path construction operation is useful, which draws part of a circle or ellipse. This `arc` operation must be followed by a triple in rounded brackets, where the components of the triple are separated by colons. The first two components are angles, the last one is a radius. An example would be `(10:80:10pt)`, which means “an arc from 10 degrees to 80 degrees on a circle of radius 10pt.” Karl obviously needs an arc from 0° to 30°. The radius should be something relatively small, perhaps around one third of the circle's radius. This gives: `(0:30:3mm)`.

When one uses the arc path construction operation, the specified arc will be added with its starting point at the current position. So, we first have to “get there.”

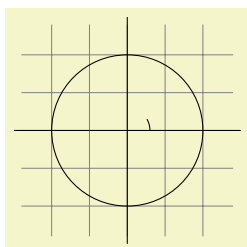

```
\begin{tikzpicture}
\draw[step=.5cm,gray,very thin] (-1.4,-1.4) grid (1.4,1.4);
\draw (-1.5,0) -- (1.5,0);
\draw (0,-1.5) -- (0,1.5);
\draw (0,0) circle (1cm);
\draw (3mm,0mm) arc (0:30:3mm);
\end{tikzpicture}
```

Karl thinks this is really a bit small and he cannot continue unless he learns how to do scaling. For this, he can add the `[scale=3]` option. He could add this option to each `\draw` command, but that would be awkward. Instead, he adds it to the whole environment, which causes this option to apply to everything within.

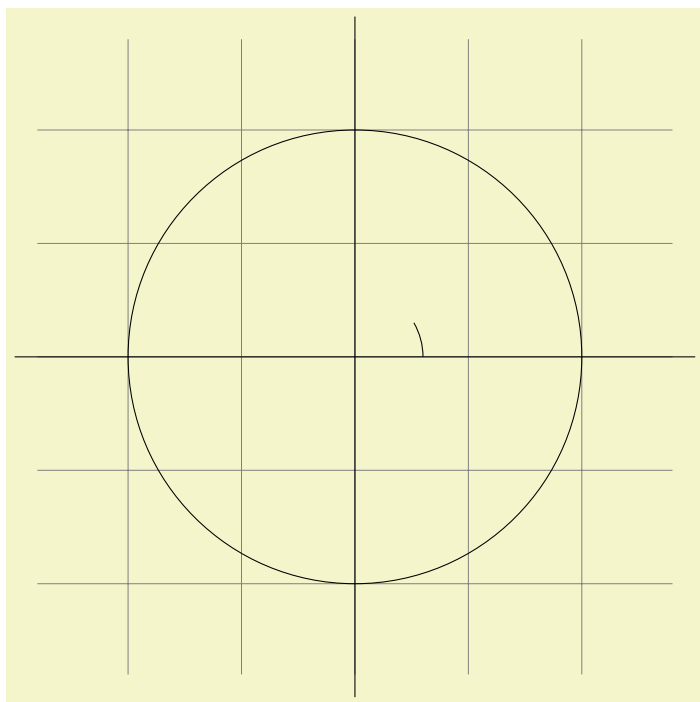

```
\begin{tikzpicture}[scale=3]
  \draw[step=.5cm,gray,very thin] (-1.4,-1.4) grid (1.4,1.4);
  \draw (-1.5,0) -- (1.5,0);
  \draw (0,-1.5) -- (0,1.5);
  \draw (0,0) circle (1cm);
  \draw (3mm,0mm) arc (0:30:3mm);
\end{tikzpicture}
```

As for circles, you can specify “two” radii in order to get an elliptical arc.

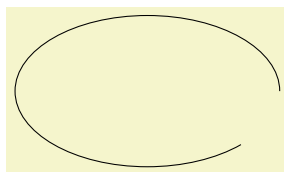

```
\tikz \draw (0,0) arc (0:315:1.75cm and 1cm);
```

## 2.11 Clipping a Path

In order to save space in this manual, it would be nice to clip Karl’s graphics a bit so that we can focus on the “interesting” parts. Clipping is pretty easy in TikZ. You can use the `\clip` command clip all subsequent drawing. It works like `\draw`, only it does not draw anything, but uses the given path to clip everything subsequently.

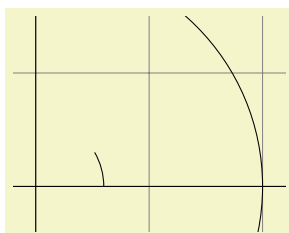

```
\begin{tikzpicture}[scale=3]
  \clip (-0.1,-0.2) rectangle (1.1,0.75);
  \draw[step=.5cm,gray,very thin] (-1.4,-1.4) grid (1.4,1.4);
  \draw (-1.5,0) -- (1.5,0);
  \draw (0,-1.5) -- (0,1.5);
  \draw (0,0) circle (1cm);
  \draw (3mm,0mm) arc (0:30:3mm);
\end{tikzpicture}
```

You can also do both at the same time: Draw *and* clip a path. For this, use the `\draw` command and add the `clip` option. (This is not the whole picture: You can also use the `\clip` command and add the `draw` option. Well, that is also not the whole picture: In reality, `\draw` is just a shorthand for `\path[draw]` and `\clip` is a shorthand for `\path[clip]` and you could also say `\path[draw,clip]`.) Here is an example:

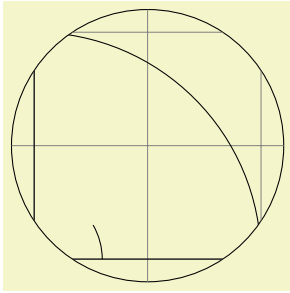

```
\begin{tikzpicture}[scale=3]
\clip[draw] (0.5,0.5) circle (.6cm);
\draw[step=.5cm,gray,very thin] (-1.4,-1.4) grid (1.4,1.4);
\draw (-1.5,0) -- (1.5,0);
\draw (0,-1.5) -- (0,1.5);
\draw (0,0) circle (1cm);
\draw (3mm,0mm) arc (0:30:3mm);
\end{tikzpicture}
```

## 2.12 Parabola and Sine Path Construction

Although Karl does not need them for his picture, he is pleased to learn that there are `parabola` and `sin` and `cos` path operations for adding parabolas and sine and cosine curves to the current path. For the `parabola` operation, the current point will lie on the parabola as well as the point given after the parabola operation. Consider the following example:



```
\tikz \draw (0,0) rectangle (1,1) (0,0) parabola (1,1);
```

It is also possible to place the bend somewhere else:



```
\tikz \draw[x=1pt,y=1pt] (0,0) parabola bend (4,16) (6,12);
```

The operations `sin` and `cos` add a sine or cosine curve in the interval  $[0, \pi/2]$  such that the previous current point is at the start of the curve and the curve ends at the given end point. Here are two examples:

A sine curve.

```
A sine \tikz \draw[x=1ex,y=1ex] (0,0) sin (1.57,1); curve.
```



```
\tikz \draw[x=1.57ex,y=1ex] (0,0) sin (1,1) cos (2,0) sin (3,-1) cos (4,0)
(0,1) cos (1,0) sin (2,-1) cos (3,0) sin (4,1);
```

## 2.13 Filling and Drawing

Returning to the picture, Karl now wants the angle to be “filled” with a very light green. For this he uses `\fill` instead of `\draw`. Here is what Karl does:

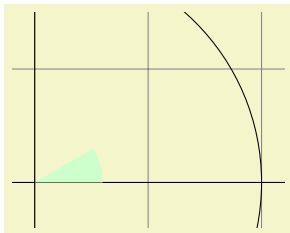

```
\begin{tikzpicture}[scale=3]
\clip (-0.1,-0.2) rectangle (1.1,0.75);
\draw[step=.5cm,gray,very thin] (-1.4,-1.4) grid (1.4,1.4);
\draw (-1.5,0) -- (1.5,0);
\draw (0,-1.5) -- (0,1.5);
\draw (0,0) circle (1cm);
\fill[green!20!white] (0,0) -- (3mm,0mm) arc (0:30:3mm) -- (0,0);
\end{tikzpicture}
```

The color `green!20!white` means 20% green and 80% white mixed together. Such color expressions are possible since PGF uses Uwe Kern’s `xcolor` package, see the documentation of that package for details on color expressions.

What would have happened, if Karl had not “closed” the path using `--(0,0)` at the end? In this case, the path is closed automatically, so this could have been omitted. Indeed, it would even have been better to write the following, instead:

```
\fill[green!20!white] (0,0) -- (3mm,0mm) arc (0:30:3mm) -- cycle;
```

The `--cycle` causes the current path to be closed (actually the current part of the current path) by smoothly joining the first and last point. To appreciate the difference, consider the following example:



```
\begin{tikzpicture}[line width=5pt]
\draw (0,0) -- (1,0) -- (1,1) -- (0,0);
\draw (2,0) -- (3,0) -- (3,1) -- cycle;
\useasboundingbox (0,1.5); % make bounding box higher
\end{tikzpicture}
```

You can also fill and draw a path at the same time using the `\filldraw` command. This will first draw the path, then fill it. This may not seem too useful, but you can specify different colors to be used for filling and for stroking. These are specified as optional arguments like this:

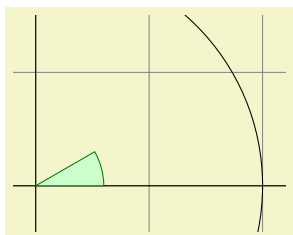

```
\begin{tikzpicture}[scale=3]
\clip (-0.1,-0.2) rectangle (1.1,0.75);
\draw[step=.5cm,gray,very thin] (-1.4,-1.4) grid (1.4,1.4);
\draw (-1.5,0) -- (1.5,0);
\draw (0,-1.5) -- (0,1.5);
\draw (0,0) circle (1cm);
\filldraw[fill=green!20!white, draw=green!50!black]
(0,0) -- (3mm,0mm) arc (0:30:3mm) -- cycle;
\end{tikzpicture}
```

## 2.14 Shading

Karl briefly considers the possibility of making the angle “more fancy” by *shading* it. Instead of filling the with a uniform color, a smooth transition between different colors is used. For this, `\shade` and `\shadedraw`, for shading and drawing at the same time, can be used:



```
\tikz \shade (0,0) rectangle (2,1) (3,0.5) circle (.5cm);
```

The default shading is a smooth transition from gray to white. To specify different colors, you can use options:



```
\begin{tikzpicture}[rounded corners,ultra thick]
\shade[top color=yellow,bottom color=black] (0,0) rectangle +(2,1);
\shade[left color=yellow,right color=black] (3,0) rectangle +(2,1);
\shadedraw[inner color=yellow,outer color=black,draw=yellow] (6,0) rectangle +(2,1);
\shade[ball color=green] (9,.5) circle (.5cm);
\end{tikzpicture}
```

For Karl, the following might be appropriate:

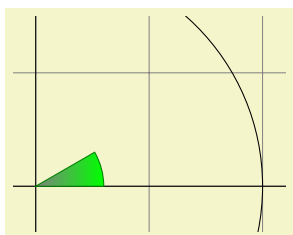

```
\begin{tikzpicture}[scale=3]
\clip (-0.1,-0.2) rectangle (1.1,0.75);
\draw[step=.5cm,gray,very thin] (-1.4,-1.4) grid (1.4,1.4);
\draw (-1.5,0) -- (1.5,0);
\draw (0,-1.5) -- (0,1.5);
\draw (0,0) circle (1cm);
\shadedraw[left color=gray,right color=green, draw=green!50!black]
(0,0) -- (3mm,0mm) arc (0:30:3mm) -- cycle;
\end{tikzpicture}
```

However, he wisely decides that shadings usually only distract without adding anything to the picture.

## 2.15 Specifying Coordinates

Karl now wants to add the sine and cosine lines. He knows already that he can use the `color=` option to set the lines’s colors. So, what is the best way to specify the coordinates?

There are different ways of specifying coordinates. The easiest way is to say something like `(10pt,2cm)`. This means 10pt in  $x$ -direction and 2cm in  $y$ -directions. Alternatively, you can also leave out the units as in `(1,2)`, which means “one times the current  $x$ -vector plus twice the current  $y$ -vector.” These vectors default to 1cm in the  $x$ -direction and 1cm in the  $y$ -direction, respectively.

In order to specify points in polar coordinates, use the notation `(30:1cm)`, which means 1cm in direction 30 degree. This is obviously quite useful to “get to the point  $(\cos 30^\circ, \sin 30^\circ)$  on the circle.”

You can add a single `+` sign in front of a coordinate or two of them as in `+(1cm,0cm)` or `++(0cm,2cm)`. Such coordinates are interpreted differently: The first form means “1cm upwards from the previous specified position” and the second means “2cm to the right of the previous specified position, making this the new specified position.” For example, we can draw the sine line as follows:

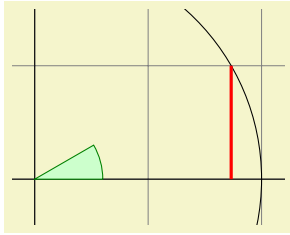

```
\begin{tikzpicture}[scale=3]
\clip (-0.1,-0.2) rectangle (1.1,0.75);
\draw[step=.5cm,gray,very thin] (-1.4,-1.4) grid (1.4,1.4);
\draw (-1.5,0) -- (1.5,0);
\draw (0,-1.5) -- (0,1.5);
\draw (0,0) circle (1cm);
\filldraw[fill=green!20,draw=green!50!black]
(0,0) -- (3mm,0mm) arc (0:30:3mm) -- cycle;
\draw[red,very thick] (30:1cm) -- +(0,-0.5);
\end{tikzpicture}
```

Karl used the fact  $\sin 30^\circ = 1/2$ . However, he very much doubts that his students know this, so it would be nice to have a way of specifying “the point straight down from (30:1cm) that lies on the  $x$ -axis.” This is, indeed, possible using a special syntax: Karl can write (30:1cm |- 0,0). In general, the meaning of  $(\langle p \rangle \mid - \langle q \rangle)$  is “the intersection of a vertical line through  $p$  and a horizontal line through  $q$ .”

Next, let us draw the cosine line. One way would be to say (30:1cm |- 0,0) -- (0,0). Another way is the following: we “continue” from where the sine ends:

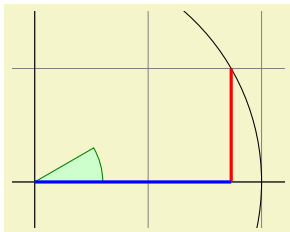

```
\begin{tikzpicture}[scale=3]
\clip (-0.1,-0.2) rectangle (1.1,0.75);
\draw[step=.5cm,gray,very thin] (-1.4,-1.4) grid (1.4,1.4);
\draw (-1.5,0) -- (1.5,0);
\draw (0,-1.5) -- (0,1.5);
\draw (0,0) circle (1cm);
\filldraw[fill=green!20,draw=green!50!black] (0,0) -- (3mm,0mm) arc
(0:30:3mm) -- cycle;
\draw[red,very thick] (30:1cm) -- +(0,-0.5);
\draw[blue,very thick] (30:1cm) ++(0,-0.5) -- (0,0);
\end{tikzpicture}
```

Note there is no -- between (30:1cm) and +(0,-0.5). In detail, this path is interpreted as follows: “First, the (30:1cm) tells me to move by pen to  $(\cos 30^\circ, 1/2)$ . Next, there comes another coordinate specification, so I move my pen there without drawing anything. This new point is half a unit down from the last position, thus it is at  $(\cos 30^\circ, 0)$ . Finally, I move the pen to the origin, but this time drawing something (because of the --).”

To appreciate the difference between + and ++ consider the following example:

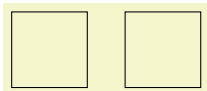

```
\begin{tikzpicture}
\def\rectanglepath{-- ++(1cm,0cm) -- ++(0cm,1cm) -- ++(-1cm,0cm) -- cycle}
\draw (0,0) \rectanglepath;
\draw (1.5,0) \rectanglepath;
\end{tikzpicture}
```

By comparison, when using a single +, the coordinates are different:

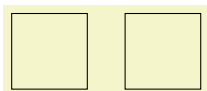

```
\begin{tikzpicture}
\def\rectanglepath{-- +(1cm,0cm) -- +(1cm,1cm) -- +(0cm,1cm) -- cycle}
\draw (0,0) \rectanglepath;
\draw (1.5,0) \rectanglepath;
\end{tikzpicture}
```

Naturally, all of this could have been written more clearly and more economically like this (either with a single or a double +):

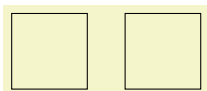

```
\tikz \draw (0,0) rectangle +(1,1) (1.5,0) rectangle +(1,1);
```

## 2.16 Intersecting Paths

Karl is left with the line for  $\tan \alpha$ , which seems difficult to specify using transformations and polar coordinates. For this he needs another way of specifying coordinates: Karl can specify intersections of paths as coordinates. The line for  $\tan \alpha$  starts at (1,0) and goes upward to a point that is at the intersection of a line going “up” and a line going from the origin through (30:1cm). Such computations are made available by the `intersections` library.

What Karl must do is to create two “invisible” paths that intersect at the position of interest. Creating paths that are not otherwise seen can be done using the `\path` command without any options like `draw` or



fill. Then, Karl can add the `name path` option to the path for later reference. Once the paths have been constructed, Karl can use the `name intersections` to assign names to the coordinate for later reference.

```
\path [name path=upward line] (1,0) -- (1,1);
\path [name path=sloped line] (0,0) -- (30:1.5cm); % a bit longer, so that there is an intersection

\draw [name intersections={of=upward line and sloped line, by=x}]
[very thick,orange] (1,0) -- (x);
```

## 2.17 Adding Arrow Tips

Karl now wants to add the little arrow tips at the end of the axes. He has noticed that in many plots, even in scientific journals, these arrow tips seem to be missing, presumably because the generating programs cannot produce them. Karl thinks arrow tips belong at the end of axes. His son agrees. His students do not care about arrow tips.

It turns out that adding arrow tips is pretty easy: Karl adds the option `->` to the drawing commands for the axes:

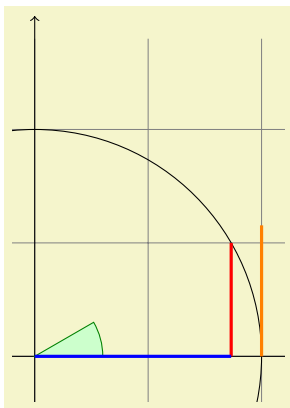

```
\begin{tikzpicture}[scale=3]
\clip (-0.1,-0.2) rectangle (1.1,1.51);
\draw[step=.5cm,gray,very thin] (-1.4,-1.4) grid (1.4,1.4);
\draw[->] (-1.5,0) -- (1.5,0);
\draw[->] (0,-1.5) -- (0,1.5);
\draw (0,0) circle (1cm);
\filldraw[fill=green!20,draw=green!50!black] (0,0) -- (3mm,0mm) arc
(0:30:3mm) -- cycle;
\draw[red,very thick] (30:1cm) -- +(0,-0.5);
\draw[blue,very thick] (30:1cm) ++(0,-0.5) -- (0,0);

\path [name path=upward line] (1,0) -- (1,1);
\path [name path=sloped line] (0,0) -- (30:1.5cm);
\draw [name intersections={of=upward line and sloped line, by=x}]
[very thick,orange] (1,0) -- (x);
\end{tikzpicture}
```

If Karl had used the option `<-` instead of `->`, arrow tips would have been put at the beginning of the path. The option `<->` puts arrow tips at both ends of the path.

There are certain restrictions to the kind of paths to which arrow tips can be added. As a rule of thumb, you can add arrow tips only to a single open “line.” For example, you should not try to add tips to, say, a rectangle or a circle. (You can try, but no guarantees as to what will happen now or in future versions.) However, you can add arrow tips to curved paths and to paths that have several segments, as in the following examples:

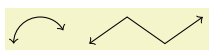

```
\begin{tikzpicture}
\draw [<->] (0,0) arc (180:30:10pt);
\draw [<->] (1,0) -- (1.5cm,10pt) -- (2cm,0pt) -- (2.5cm,10pt);
\end{tikzpicture}
```

Karl has a more detailed look at the arrow that TikZ puts at the end. It looks like this when he zooms it:  $\rightarrow$ . The shape seems vaguely familiar and, indeed, this is exactly the end of  $\text{T}_{\text{E}}\text{X}$ 's standard arrow used in something like  $f: A \rightarrow B$ .

Karl likes the arrow, especially since it is not “as thick” as the arrows offered by many other packages. However, he expects that, sometimes, he might need to use some other kinds of arrow. To do so, Karl can say  $\text{>}=\langle\textit{right arrow tip kind}\rangle$ , where  $\langle\textit{right arrow tip kind}\rangle$  is a special arrow tip specification. For example, if Karl says  $\text{>}=\textit{stealth}$ , then he tells TikZ that he would like “stealth-fighter-like” arrow tips:



```
\begin{tikzpicture}[>=stealth]
\draw [->] (0,0) arc (180:30:10pt);
\draw [<<- ,very thick] (1,0) -- (1.5cm,10pt) -- (2cm,0pt) -- (2.5cm,10pt);
\end{tikzpicture}
```

Karl wonders whether such a military name for the arrow type is really necessary. He is not really mollified when his son tells him that Microsoft’s PowerPoint uses the same name. He decides to have his students discuss this at some point.

In addition to `stealth` there are several other predefined arrow tip kinds Karl can choose from, see Section 23. Furthermore, he can define arrows types himself, if he needs new ones.

## 2.18 Scoping

Karl saw already that there are numerous graphic options that affect how paths are rendered. Often, he would like to apply certain options to a whole set of graphic commands. For example, Karl might wish to draw three paths using a **thick** pen, but would like everything else to be drawn “normally.”

If Karl wishes to set a certain graphic option for the whole picture, he can simply pass this option to the `\tikz` command or to the `{tikzpicture}` environment (Gerda would pass the options to `\tikzpicture` and Hans passes them to `\starttikzpicture`). However, if Karl wants to apply graphic options to a local group, he put these commands inside a `{scope}` environment (Gerda uses `\scope` and `\endscope`, Hans uses `\startscope` and `\stopscope`). This environment takes graphic options as an optional argument and these options apply to everything inside the scope, but not to anything outside.

Here is an example:



```
\begin{tikzpicture}[ultra thick]
  \draw (0,0) -- (0,1);
  \begin{scope}[thin]
    \draw (1,0) -- (1,1);
    \draw (2,0) -- (2,1);
  \end{scope}
  \draw (3,0) -- (3,1);
\end{tikzpicture}
```

Scoping has another interesting effect: Any changes to the clipping area are local to the scope. Thus, if you say `\clip` somewhere inside a scope, the effect of the `\clip` command ends at the end of the scope. This is useful since there is no other way of “enlarging” the clipping area.

Karl has also already seen that giving options to commands like `\draw` apply only to that command. It turns out that the situation is slightly more complex. First, options to a command like `\draw` are not really options to the command, but they are “path options” and can be given anywhere on the path. So, instead of `\draw[thin] (0,0) -- (1,0);` one can also write `\draw (0,0) [thin] -- (1,0);` or `\draw (0,0) -- (1,0) [thin];`; all of these have the same effect. This might seem strange since in the last case, it would appear that the `thin` should take effect only “after” the line from  $(0,0)$  to  $(1,0)$  has been drawn. However, most graphic options only apply to the whole path. Indeed, if you say both `thin` and `thick` on the same path, the last option given will “win.”

When reading the above, Karl notices that only “most” graphic options apply to the whole path. Indeed, all transformation options do *not* apply to the whole path, but only to “everything following them on the path.” We will have a more detailed look at this in a moment. Nevertheless, all options given during a path construction apply only to this path.

## 2.19 Transformations

When you specify a coordinate like  $(1\text{cm}, 1\text{cm})$ , where is that coordinate placed on the page? To determine the position, TikZ, TeX, and PDF or PostScript all apply certain transformations to the given coordinate in order to determine the final position on the page.

TikZ provides numerous options that allow you to transform coordinates in PGF’s private coordinate system. For example, the `xshift` option allows you to shift all subsequent points by a certain amount:



```
\tikz \draw (0,0) -- (0,0.5) [xshift=2pt] (0,0) -- (0,0.5);
```

It is important to note that you can change transformation “in the middle of a path,” a feature that is not supported by PDF or PostScript. The reason is that PGF keeps track of its own transformation matrix.

Here is a more complicated example:

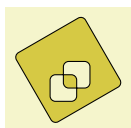

```
\begin{tikzpicture}[even odd rule,rounded corners=2pt,x=10pt,y=10pt]
  \filldraw[fill=examplefill] (0,0) rectangle (1,1)
  [xshift=5pt,yshift=5pt] (0,0) rectangle (1,1)
  [rotate=30] (-1,-1) rectangle (2,2);
\end{tikzpicture}
```

The most useful transformations are `xshift` and `yshift` for shifting, `shift` for shifting to a given point as in `shift={(1,0)}` or `shift={+(0,0)}` (the braces are necessary so that TeX does not mistake the comma for separating options), `rotate` for rotating by a certain angle (there is also a `rotate around` for rotating around a given point), `scale` for scaling by a certain factor, `xscale` and `yscale` for scaling only in the  $x$ - or  $y$ -direction (`xscale=-1` is a flip), and `xslant` and `yslant` for slanting. If these transformation and those

that I have not mentioned are not sufficient, the `cm` option allows you to apply an arbitrary transformation matrix. Karl's students, by the way, do not know what a transformation matrix is.

## 2.20 Repeating Things: For-Loops

Karl's next aim is to add little ticks on the axes at positions  $-1$ ,  $-1/2$ ,  $1/2$ , and  $1$ . For this, it would be nice to use some kind of "loop," especially since he wishes to do the same thing at each of these positions. There are different packages for doing this. L<sup>A</sup>T<sub>E</sub>X has its own internal command for this, `pstricks` comes along with the powerful `\multido` command. All of these can be used together with PGF and TikZ, so if you are familiar with them, feel free to use them. PGF introduces yet another command, called `\foreach`, which I introduced since I could never remember the syntax of the other packages. `\foreach` is defined in the package `pgffor` and can be used independently of PGF. TikZ includes it automatically.

In its basic form, the `\foreach` command is easy to use:

```
x = 1, x = 2, x = 3, \foreach \x in {1,2,3} {$x =\x$, }
```

The general syntax is `\foreach <variable> in {<list of values>} <commands>`. Inside the `<commands>`, the `<variable>` will be assigned to the different values. If the `<commands>` do not start with a brace, everything up to the next semicolon is used as `<commands>`.

For Karl and the ticks on the axes, he could use the following code:

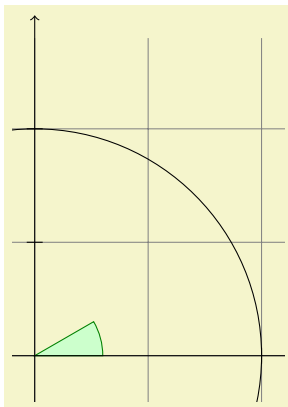

```
\begin{tikzpicture}[scale=3]
\clip (-0.1,-0.2) rectangle (1.1,1.51);
\draw[step=.5cm,gray,very thin] (-1.4,-1.4) grid (1.4,1.4);
\filldraw[fill=green!20,draw=green!50!black] (0,0) -- (3mm,0mm) arc
(0:30:3mm) -- cycle;
\draw[->] (-1.5,0) -- (1.5,0);
\draw[->] (0,-1.5) -- (0,1.5);
\draw (0,0) circle (1cm);

\foreach \x in {-1cm,-0.5cm,1cm}
\draw (\x,-1pt) -- (\x,1pt);
\foreach \y in {-1cm,-0.5cm,0.5cm,1cm}
\draw (-1pt,\y) -- (1pt,\y);
\end{tikzpicture}
```

As a matter of fact, there are many different ways of creating the ticks. For example, Karl could have put the `\draw ...`; inside curly braces. He could also have used, say,

```
\foreach \x in {-1,-0.5,1}
\draw[xshift=\x cm] (0pt,-1pt) -- (0pt,1pt);
```

Karl is curious what would happen in a more complicated situation where there are, say, 20 ticks. It seems bothersome to explicitly mention all these numbers in the set for `\foreach`. Indeed, it is possible to use `...` inside the `\foreach` statement to iterate over a large number of values (which must, however, be dimensionless real numbers) as in the following example:

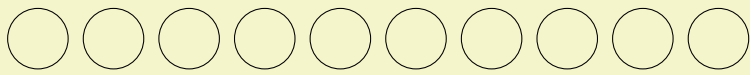

```
\tikz \foreach \x in {1,...,10}
\draw (\x,0) circle (0.4cm);
```

If you provide *two* numbers before the `...`, the `\foreach` statement will use their difference for the stepping:

```
\tikz \foreach \x in {-1,-0.5,...,1}
\draw (\x cm,-1pt) -- (\x cm,1pt);
```

We can also nest loops to create interesting effects:

1,5	2,5	3,5	4,5	5,5		7,5	8,5	9,5	10,5	11,5	12,5
1,4	2,4	3,4	4,4	5,4		7,4	8,4	9,4	10,4	11,4	12,4
1,3	2,3	3,3	4,3	5,3		7,3	8,3	9,3	10,3	11,3	12,3
1,2	2,2	3,2	4,2	5,2		7,2	8,2	9,2	10,2	11,2	12,2
1,1	2,1	3,1	4,1	5,1		7,1	8,1	9,1	10,1	11,1	12,1

```

\begin{tikzpicture}
  \foreach \x in {1,2,...,5,7,8,...,12}
  \foreach \y in {1,...,5}
  {
    \draw (\x,\y) +(-.5,-.5) rectangle ++(.5,.5);
    \draw (\x,\y) node{\x,\y};
  }
\end{tikzpicture}

```

The `\foreach` statement can do even trickier stuff, but the above gives the idea.

## 2.21 Adding Text

Karl is, by now, quite satisfied with the picture. However, the most important parts, namely the labels, are still missing!

TikZ offers an easy-to-use and powerful system for adding text and, more generally, complex shapes to a picture at specific positions. The basic idea is the following: When TikZ is constructing a path and encounters the keyword `node` in the middle of a path, it reads a *node specification*. The keyword `node` is typically followed by some options and then some text between curly braces. This text is put inside a normal TeX box (if the node specification directly follows a coordinate, which is usually the case, TikZ is able to perform some magic so that it is even possible to use verbatim text inside the boxes) and then placed at the current position, that is, at the last specified position (possibly shifted a bit, according to the given options). However, all nodes are drawn only after the path has been completely drawn/filled/shaded/clipped/whatever.

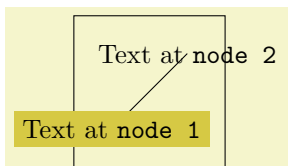

```

\begin{tikzpicture}
  \draw (0,0) rectangle (2,2);
  \draw (0.5,0.5) node [fill=examplefill]
    {Text at \verb!node 1!}
    -- (1.5,1.5) node {Text at \verb!node 2!};
\end{tikzpicture}

```

Obviously, Karl would not only like to place nodes *on* the last specified position, but also to the left or the right of these positions. For this, every node object that you put in your picture is equipped with several *anchors*. For example, the `north` anchor is in the middle at the upper end of the shape, the `south` anchor is at the bottom and the `north east` anchor is in the upper right corner. When you given the option `anchor=north`, the text will be placed such that this northern anchor will lie on the current position and the text is, thus, below the current position. Karl uses this to draw the ticks as follows:

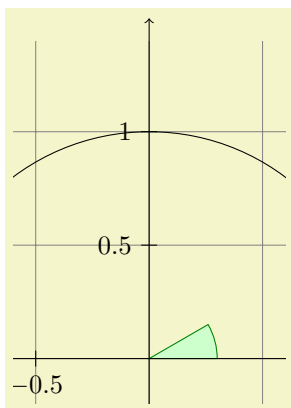

```

\begin{tikzpicture}[scale=3]
  \clip (-0.6,-0.2) rectangle (0.6,1.51);
  \draw[step=.5cm,help lines] (-1.4,-1.4) grid (1.4,1.4);
  \filldraw[fill=green!20,draw=green!50!black]
    (0,0) -- (3mm,0mm) arc (0:30:3mm) -- cycle;
  \draw[->] (-1.5,0) -- (1.5,0); \draw[->] (0,-1.5) -- (0,1.5);
  \draw (0,0) circle (1cm);

  \foreach \x in {-1,-0.5,1}
    \draw (\x cm,1pt) -- (\x cm,-1pt) node[anchor=north] {\x$};
  \foreach \y in {-1,-0.5,0.5,1}
    \draw (1pt,\y cm) -- (-1pt,\y cm) node[anchor=east] {\y$};
\end{tikzpicture}

```

This is quite nice, already. Using these anchors, Karl can now add most of the other text elements. However, Karl thinks that, though “correct,” it is quite counter-intuitive that in order to place something *below* a given point, he has to use the *north* anchor. For this reason, there is an option called `below`, which does the same as `anchor=north`. Similarly, `above right` does the same as `anchor=south east`. In addition, `below` takes an optional dimension argument. If given, the shape will additionally be shifted downwards by the given amount. So, `below=1pt` can be used to put a text label below some point and, additionally shift it 1pt downwards.

Karl is not quite satisfied with the ticks. He would like to have  $1/2$  or  $\frac{1}{2}$  shown instead of 0.5, partly to show off the nice capabilities of  $\text{\TeX}$  and  $\text{\TikZ}$ , partly because for positions like  $1/3$  or  $\pi$  it is certainly very much preferable to have the “mathematical” tick there instead of just the “numeric” tick. His students, on the other hand, prefer 0.5 over  $1/2$  since they are not too fond of fractions in general.

Karl now faces a problem: For the `\foreach` statement, the position `\x` should still be given as 0.5 since  $\text{\TikZ}$  will not know where `\frac{1}{2}` is supposed to be. On the other hand, the typeset text should really be `\frac{1}{2}`. To solve this problem, `\foreach` offers a special syntax: Instead of having one variable `\x`, Karl can specify two (or even more) variables separated by a slash as in `\x / \xtext`. Then, the elements in the set over which `\foreach` iterates must also be of the form `\langle first \rangle / \langle second \rangle`. In each iteration, `\x` will be set to `\langle first \rangle` and `\xtext` will be set to `\langle second \rangle`. If no `\langle second \rangle` is given, the `\langle first \rangle` will be used again. So, here is the new code for the ticks:

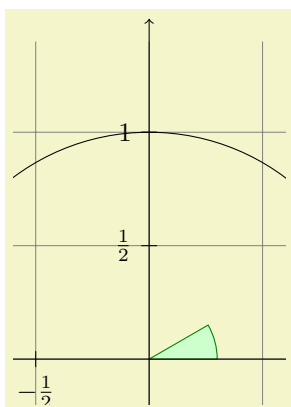

```

\begin{tikzpicture}[scale=3]
  \clip (-0.6,-0.2) rectangle (0.6,1.51);
  \draw[step=.5cm,help lines] (-1.4,-1.4) grid (1.4,1.4);
  \filldraw[fill=green!20,draw=green!50!black]
    (0,0) -- (3mm,0mm) arc (0:30:3mm) -- cycle;
  \draw[->] (-1.5,0) -- (1.5,0); \draw[->] (0,-1.5) -- (0,1.5);
  \draw (0,0) circle (1cm);

  \foreach \x/\xtext in {-1, -0.5/-\frac{1}{2}, 1}
    \draw (\x cm,1pt) -- (\x cm,-1pt) node[anchor=north] {\xtext$};
  \foreach \y/\ytext in {-1, -0.5/-\frac{1}{2}, 0.5/\frac{1}{2}, 1}
    \draw (1pt,\y cm) -- (-1pt,\y cm) node[anchor=east] {\ytext$};
\end{tikzpicture}

```

Karl is quite pleased with the result, but his son points out that this is still not perfectly satisfactory: The grid and the circle interfere with the numbers and decrease their legibility. Karl is not very concerned by this (his students do not even notice), but his son insists that there is an easy solution: Karl can add the `[fill=white]` option to fill out the background of the text shape with a white color.

The next thing Karl wants to do is to add the labels like  $\sin \alpha$ . For this, he would like to place a label “in the middle of line.” To do so, instead of specifying the label `node {\sin\alpha}` directly after one of the endpoints of the line (which would place the label at that endpoint), Karl can give the label directly after the `--`, before the coordinate. By default, this places the label in the middle of the line, but the `pos=` options can be used to modify this. Also, options like `near start` and `near end` can be used to modify this position:

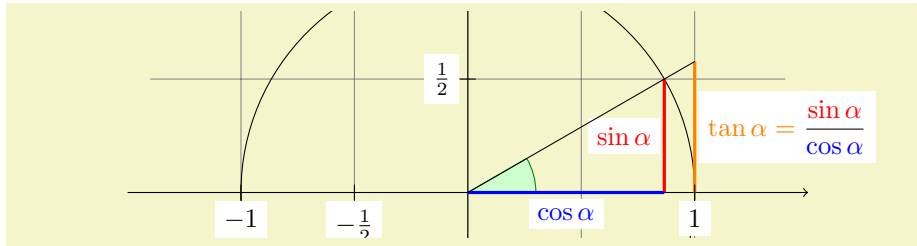

```

\begin{tikzpicture}[scale=3]
  \clip (-2,-0.2) rectangle (2,0.8);
  \draw[step=.5cm,gray,very thin] (-1.4,-1.4) grid (1.4,1.4);
  \filldraw[fill=green!20,draw=green!50!black] (0,0) -- (3mm,0mm) arc
  (0:30:3mm) -- cycle;
  \draw[->] (-1.5,0) -- (1.5,0) coordinate (x axis);
  \draw[->] (0,-1.5) -- (0,1.5) coordinate (y axis);
  \draw (0,0) circle (1cm);

  \draw[very thick,red]
    (30:1cm) -- node[left=1pt,fill=white] {\sin \alpha} (30:1cm |- x axis);
  \draw[very thick,blue]
    (30:1cm |- x axis) -- node[below=2pt,fill=white] {\cos \alpha} (0,0);
  \path [name path=upward line] (1,0) -- (1,1);
  \path [name path=sloped line] (0,0) -- (30:1.5cm);
  \draw [name intersections={of=upward line and sloped line, by=t}]
    [very thick,orange] (1,0) -- node [right=1pt,fill=white]
    {\displaystyle \tan \alpha \color{black}=
     \frac{\color{red}\sin \alpha}{\color{blue}\cos \alpha}} (t);

  \draw (0,0) -- (t);

  \foreach \x/\xtext in {-1, -0.5/-\frac{1}{2}, 1}
    \draw (\x cm,1pt) -- (\x cm,-1pt) node[anchor=north,fill=white] {\xtext};
  \foreach \y/\ytext in {-1, -0.5/-\frac{1}{2}, 0.5/\frac{1}{2}, 1}
    \draw (1pt,\y cm) -- (-1pt,\y cm) node[anchor=east,fill=white] {\ytext};
\end{tikzpicture}

```

You can also position labels on curves and, by adding the `sloped` option, have them rotated such that they match the line's slope. Here is an example:

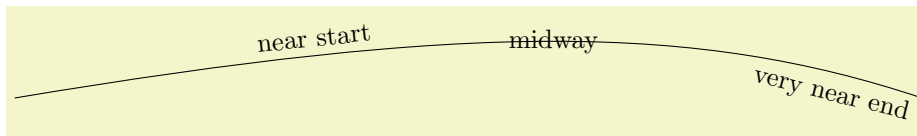

```

\begin{tikzpicture}
  \draw (0,0) .. controls (6,1) and (9,1) ..
    node[near start,sloped,above] {near start}
    node {midway}
    node[very near end,sloped,below] {very near end} (12,0);
\end{tikzpicture}

```

It remains to draw the explanatory text at the right of the picture. The main difficulty here lies in limiting the width of the text “label,” which is quite long, so that line breaking is used. Fortunately, Karl can use the option `text width=6cm` to get the desired effect. So, here is the full code:

```

\begin{tikzpicture}
  [scale=3,line cap=round,
  % Styles
  axes/.style=,
  important line/.style={very thick},
  information text/.style={rounded corners,fill=red!10,inner sep=1ex}]

% Local definitions
\def\costhirty{0.8660256}

% Colors
\colorlet{anglecolor}{green!50!black}
\colorlet{sincolor}{red}
\colorlet{tancolor}{orange!80!black}
\colorlet{coscolor}{blue}

% The graphic
\draw[help lines,step=0.5cm] (-1.4,-1.4) grid (1.4,1.4);

\draw (0,0) circle (1cm);

\begin{scope}[axes]
  \draw[>-] (-1.5,0) -- (1.5,0) node[right] {$x$} coordinate(x axis);
  \draw[>-] (0,-1.5) -- (0,1.5) node[above] {$y$} coordinate(y axis);

  \foreach \x/\xtext in {-1, -.5/-\frac{1}{2}, 1}
    \draw[xshift=\x cm] (0pt,1pt) -- (0pt,-1pt) node[below,fill=white] {$\xtext$};

  \foreach \y/\ytext in {-1, -.5/-\frac{1}{2}, .5/\frac{1}{2}, 1}
    \draw[yshift=\y cm] (1pt,0pt) -- (-1pt,0pt) node[left,fill=white] {$\ytext$};
\end{scope}

\filldraw[fill=green!20,draw=anglecolor] (0,0) -- (3mm,0pt) arc(0:30:3mm);
\draw (15:2mm) node[anglecolor] {$\alpha$};

\draw[important line,sincolor]
  (30:1cm) -- node[left=1pt,fill=white] {$\sin \alpha$} (30:1cm |- x axis);

\draw[important line,coscolor]
  (30:1cm |- x axis) -- node[below=2pt,fill=white] {$\cos \alpha$} (0,0);

\path [name path=upward line] (1,0) -- (1,1);
\path [name path=sloped line] (0,0) -- (30:1.5cm);
\draw [name intersections={of=upward line and sloped line, by=t}]
  [very thick,orange] (1,0) -- node [right=1pt,fill=white]
  {$\displaystyle \tan \alpha \color{black}=\frac{\color{red}\sin \alpha}{\color{blue}\cos \alpha}$} (t);

\draw (0,0) -- (t);

\draw[xshift=1.85cm]
  node[right,text width=6cm,information text]
  {
    The {\color{anglecolor} angle $\alpha$} is $30^\circ$ in the
    example ($\pi/6$ in radians). The {\color{sincolor}sine} of
    $\alpha$, which is the height of the red line, is
    \[
    {\color{sincolor} \sin \alpha} = 1/2.
    \]
    By the Theorem of Pythagoras ...
  };
\end{tikzpicture}

```

### 3 Tutorial: A Petri-Net for Hagen

In this second tutorial we explore the node mechanism of TikZ and PGF.

Hagen must give a talk tomorrow about his favorite formalism for distributed systems: Petri nets! Hagen used to give his talks using a blackboard and everyone seemed to be perfectly concent with this. Unfortunately, his audience has been spoiled recently with fancy projector-based presentations and there seems to be a certain amount of peer pressure that this Petri nets should also be drawn using a graphic program. One of the professors at his institutes recommends TikZ for this and Hagen decides to give it a try.

#### 3.1 Problem Statement

For his talk, Hagen wishes to create a graphic that demonstrates how a net with place capacities can be simulated by a net without capacities. The graphic should look like this, ideally:

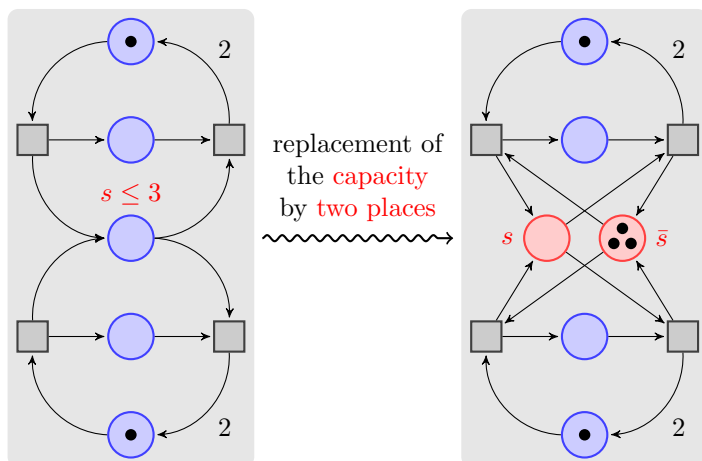

#### 3.2 Setting up the Environment

For the picture Hagen will need to load the TikZ package as did Karl in the previous tutorial. However, Hagen will also need to load some additional *library packages* that Karl did not need. These library packages contain additional definitions like extra arrow tips that are typically not needed in a picture and that need to be loaded explicitly.

Hagen will need to load several libraries: The `arrows` library for the special arrow tip used in the graphic, the `decoration.pathmorphing` library for the “snaking line” in the middle, the `background` library for the two rectangular areas that are behind the two main parts of the picture, the `fit` library to easily compute the sizes of these rectangles, and the `positioning` library for placing nodes relative to other nodes.

##### 3.2.1 Setting up the Environment in L<sup>A</sup>T<sub>E</sub>X

When using L<sup>A</sup>T<sub>E</sub>X use:

```
\documentclass{article} % say
\usepackage{tikz}
\usetikzlibrary{arrows,decorations.pathmorphing,backgrounds,positioning,fit}

\begin{document}
\begin{tikzpicture}
\draw (0,0) -- (1,1);
\end{tikzpicture}
\end{document}
```

##### 3.2.2 Setting up the Environment in Plain T<sub>E</sub>X

When using plain T<sub>E</sub>X use:



```

%% Plain TeX file
\input tikz.tex
\usetikzlibrary{arrows,decorations.pathmorphing,backgrounds,positioning,fit}
\baselineskip=12pt
\hsize=6.3truein
\vsize=8.7truein
\tikzpicture
  \draw (0,0) -- (1,1);
\endtikzpicture
\bye

```

### 3.2.3 Setting up the Environment in ConT<sub>E</sub>Xt

When using ConT<sub>E</sub>Xt use:

```

%% ConTeXt file
\usemodule[tikz]
\usetikzlibrary[arrows,decorations.pathmorphing,backgrounds,positioning,fit]

\starttext
  \starttikzpicture
    \draw (0,0) -- (1,1);
  \stoptikzpicture
\starttext

```

## 3.3 Introduction to Nodes

In principle, we already know how to create the graphics that Hagen desires (except perhaps for the snaked line, we will come to that): We start with big light gray rectangle and then add lots of circles and small rectangle, plus some arrows.

However, this approach has numerous disadvantages: First, it is hard to change anything at a later stage. For example, if we decide to add more places to the Petri nets (the circles are called places in Petri net theory), all of the coordinates change and we need to recalculate everything. Second, it is hard to read the code for the Petri net as it just a long and complicated list of coordinates and drawing commands – the underlying structure of the Petri net is lost.

Fortunately, TikZ offers a powerful mechanism for avoiding the above problems: nodes. We already came across nodes in the previous tutorial, where we used them to add labels to Karl’s graphic. In the present tutorial we will see that nodes are much more powerful.

A node is a small part of a picture. When a node is created, you provide a position where the node should be drawn and a *shape*. A node of shape `circle` will be drawn as a circle, a node of shape `rectangle` as a rectangle, and so on. A node may also contain same text, which is why Karl used nodes to show text. Finally, a node can get a *name* for later reference.

In Hagen’s picture we will use nodes for the places and for the transitions of the Petri net (the places are the circles, the transitions are the rectangles). Let us start with the upper half of the left Petri net. In this upper half we have three places and two transitions. Instead of drawing three circles and two rectangles, we use three nodes of shape `circle` and two nodes of shape `rectangle`.

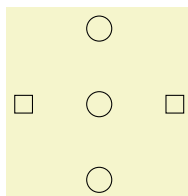

```

\begin{tikzpicture}
  \path ( 0,2) node [shape=circle,draw] {}
        ( 0,1) node [shape=circle,draw] {}
        ( 0,0) node [shape=circle,draw] {}
        ( 1,1) node [shape=rectangle,draw] {}
        (-1,1) node [shape=rectangle,draw] {};
\end{tikzpicture}

```

Hagen notes that this does not quite look like the final picture, but it seems like a good first step.

Let us have a more detailed look at the code. The whole picture consists of a single path. Ignoring the node operations there is not much going on in this path: It is just a sequence of coordinates with nothing “happening” between them. Indeed, even if something were to happen like a line-to or a curve-to, the `\path` command would not “do” anything with the resulting path. So, all the magic must be in the `node` commands.

In the previous tutorial we learned that a `node` will add a piece of text at the last coordinate. Thus, each of the five nodes is added at a different position. In the above code, this text is empty (because of the empty `{}`). So, why do we see anything at all? The answer is the `draw` option for the `node` operation: It causes the “shape around the text” to be drawn.

So, the code `(0,2) node [shape=circle,draw] {}` means the following: “In the main path, add a move-to to the coordinate (0,2). Then, temporarily suspend the construction of the main path while the node is build. This node will be a `circle` around an empty text. This circle is to be `drawn`, but not filled or otherwise used. Once this whole node is constructed, it is saved until after the main path is finished. Then, it is drawn.” Then following `(0,1) node [shape=circle,draw] {}` then has the following effect: “Continue the main path with a move-to to (0,1). Then construct a node at this position also. This node is also shown after the main path is finished.” And so on.

### 3.4 Placing Nodes Using the At Syntax

Hagen now understands how the `node` operation adds nodes to the path, but it seems a bit silly to create a path using the `\path` operation, consisting of numerous superfluous move-to operations, only to place nodes. He is pleased to learn that there are ways to add nodes in a more sensible manner.

First, the `node` operation allows one to add `at` (*coordinate*) in order to directly specify where the node should be placed, sidestepping the rule that nodes are placed on the last coordinate. Hagen can then write the following:

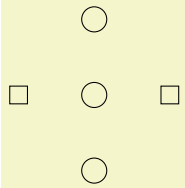
	<pre>\begin{tikzpicture}   \path node at ( 0,2) [shape=circle,draw] {}         node at ( 0,1) [shape=circle,draw] {}         node at ( 0,0) [shape=circle,draw] {}         node at ( 1,1) [shape=rectangle,draw] {}         node at (-1,1) [shape=rectangle,draw] {}; \end{tikzpicture}</pre>
---	---

Now Hagen is still left with a single empty path, but at least the path no longer contains strange move-tos. It turns out that this can be improved further: The `\node` command is an abbreviation for `\path node`, which allows Hagen to write:

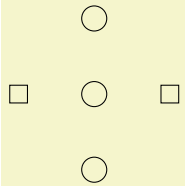
	<pre>\begin{tikzpicture}   \node at ( 0,2) [circle,draw] {};   \node at ( 0,1) [circle,draw] {};   \node at ( 0,0) [circle,draw] {};   \node at ( 1,1) [rectangle,draw] {};   \node at (-1,1) [rectangle,draw] {}; \end{tikzpicture}</pre>
---	--

Hagen likes this syntax much better than the previous one. Note that Hagen has also omitted the `shape=` since, like `color=`, *TikZ* allows you to omit the `shape=` if there is no confusion.

### 3.5 Using Styles

Feeling adventurous, Hagen tries to make the nodes look nicer. In the final picture, the circles and rectangle should be filled with different colors, resulting in the following code:

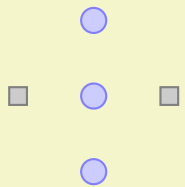
	<pre>\begin{tikzpicture}[thick]   \node at ( 0,2) [circle,draw=blue!50,fill=blue!20] {};   \node at ( 0,1) [circle,draw=blue!50,fill=blue!20] {};   \node at ( 0,0) [circle,draw=blue!50,fill=blue!20] {};   \node at ( 1,1) [rectangle,draw=black!50,fill=black!20] {};   \node at (-1,1) [rectangle,draw=black!50,fill=black!20] {}; \end{tikzpicture}</pre>
---	--

While this looks nicer in the picture, the code starts to get a bit ugly. Ideally, we would like our code to transport the message “there are three places and two transitions” and not so much which filling colors should be used.

To solve this problem, Hagen uses styles. He defines a style for places and another style for transitions:

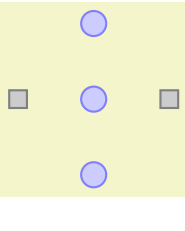
	<pre>\begin{tikzpicture}   [place/.style={circle,draw=blue!50,fill=blue!20,thick},   transition/.style={rectangle,draw=black!50,fill=black!20,thick}]   \node at ( 0,2) [place] {};   \node at ( 0,1) [place] {};   \node at ( 0,0) [place] {};   \node at ( 1,1) [transition] {};   \node at (-1,1) [transition] {}; \end{tikzpicture}</pre>
---	---

### 3.6 Node Size

Before Hagen starts naming and connecting the nodes, let us first make sure that the nodes get their final appearance. They are still too small. Indeed, Hagen wonders why they have any size at all, after all, the text is empty. The reason is that `TikZ` automatically adds some space around the text. The amount is set using the option `inner sep`. So, to increase the size of the nodes, Hagen could write:

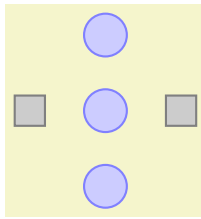

```
\begin{tikzpicture}
[inner sep=2mm,
place/.style={circle,draw=blue!50,fill=blue!20,thick},
transition/.style={rectangle,draw=black!50,fill=black!20,thick}]
\node at ( 0,2) [place] {};
\node at ( 0,1) [place] {};
\node at ( 0,0) [place] {};
\node at ( 1,1) [transition] {};
\node at (-1,1) [transition] {};
\end{tikzpicture}
```

However, this is not really the best way to achieve the desired effect. It is much better to use the `minimum size` option instead. This option allows Hagen to specify a minimum size that the node should have. If the nodes actually need to be bigger because of a longer text, it will be larger, but if the text is empty, then the node will have `minimum size`. This option is also useful to ensure that several nodes containing different amounts of text have the same size. The options `minimum height` and `minimum width` allow you to specify the minimum height and width independently.

So, what Hagen needs to do is to provide `minimum size` for the nodes. To be on the safe side, he also sets `inner sep=0pt`. This ensures that the nodes will really have size `minimum size` and not, for very small `minimum sizes`, the minimal size necessary to encompass the automatically added space.

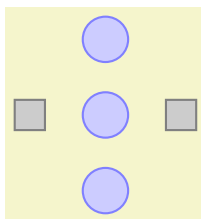

```
\begin{tikzpicture}
[place/.style={circle,draw=blue!50,fill=blue!20,thick,
inner sep=0pt,minimum size=6mm},
transition/.style={rectangle,draw=black!50,fill=black!20,thick,
inner sep=0pt,minimum size=4mm}]
\node at ( 0,2) [place] {};
\node at ( 0,1) [place] {};
\node at ( 0,0) [place] {};
\node at ( 1,1) [transition] {};
\node at (-1,1) [transition] {};
\end{tikzpicture}
```

### 3.7 Naming Nodes

Hagen's next aim is to connect the nodes using arrows. This seems like a tricky business since the arrows should not start in the middle of the nodes, but somewhere on the border and Hagen would very much like to avoid computing these positions by hand.

Fortunately, `PGF` will perform all the necessary calculations for him. However, he first has to assign names to the nodes so that he can reference them later on.

There are two ways to name a node. The first is to use the `name=` option. The second method is to write the desired name in parentheses after the `node` operation. Hagen thinks that this second method seems strange, but he will soon change his opinion.

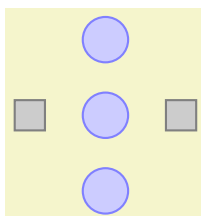

```
% ... setup styles
\begin{tikzpicture}
\node (waiting 1) at ( 0,2) [place] {};
\node (critical 1) at ( 0,1) [place] {};
\node (semaphore) at ( 0,0) [place] {};
\node (leave critical) at ( 1,1) [transition] {};
\node (enter critical) at (-1,1) [transition] {};
\end{tikzpicture}
```

Hagen is pleased to note that the names help in understanding the code. Names for nodes can be pretty arbitrary, but they should not contain commas, periods, parentheses, colons, and some other special characters. However, they can contain underscores and hyphens.

The syntax for the `node` operation is quite liberal with respect to the order in which node names, the `at` specifier, and the options must come. Indeed, you can even have multiple option blocks between the `node`

and the text in curly braces, they accumulate. You can rearrange them arbitrarily and perhaps the following might be preferable:

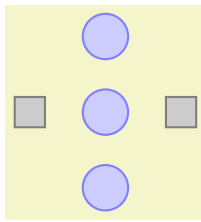

```
\begin{tikzpicture}
  \node[place]      (waiting 1)      at ( 0,2) {};
  \node[place]      (critical 1)     at ( 0,1) {};
  \node[place]      (semaphore)      at ( 0,0) {};
  \node[transition] (leave critical) at ( 1,1) {};
  \node[transition] (enter critical) at (-1,1) {};
\end{tikzpicture}
```

### 3.8 Placing Nodes Using Relative Placement

Although Hagen still wishes to connect the nodes, he first wishes to address another problem again: The placement of the nodes. Although he likes the `at` syntax, in this particular case he would prefer placing the nodes “relative to each other.” So, Hagen would like to say that the `critical 1` node should be below the `waiting 1` node, wherever the `waiting 1` node might be. There are different ways of achieving this, but the nicest one in Hagen’s case is the `below` option:

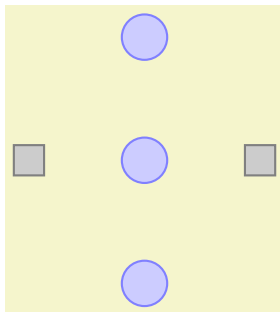

```
\begin{tikzpicture}
  \node[place]      (waiting)
  \node[place]      (critical)       [below=of waiting] {};
  \node[place]      (semaphore)      [below=of critical] {};
  \node[transition] (leave critical) [right=of critical] {};
  \node[transition] (enter critical) [left=of critical]  {};
\end{tikzpicture}
```

With the `positioning` library loaded, when an option like `below` is followed by `of`, then the position of the node is shifted such a manner that it is placed at the distance `node distance` in the specified direction of the given direction. The `node distance` is either the distance between the centers of the nodes (when the `on grid` option is set to true) or the distance between the borders (when the `on grid` option is set to false, which is the default).

Even though the above code has the same effect the earlier code, Hagen can pass it to his colleagues who will be able to just read and understand it, perhaps without even having to see the picture.

### 3.9 Adding Labels Next to Nodes

Before we have a look at how Hagen can connect the nodes, let us add the capacity “ $s \leq 3$ ” to the bottom node. For this, two approaches are possible:

1. Hagen can just add a new node above the `north` anchor of the `semaphore` node.

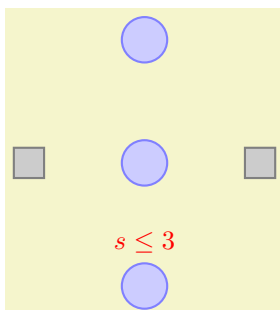

```
\begin{tikzpicture}
  \node[place]      (waiting)
  \node[place]      (critical)       [below=of waiting] {};
  \node[place]      (semaphore)      [below=of critical] {};
  \node[transition] (leave critical) [right=of critical] {};
  \node[transition] (enter critical) [left=of critical]  {};

  \node [red,above] at (semaphore.north) {$s \le 3$};
\end{tikzpicture}
```

This is a general approach that will “always work.”

2. Hagen can use the special `label` option. This option is given to a `node` and it causes *another* node to be added next to the node where the option is given. Here is the idea: When we construct the `semaphore` node, we wish to indicate that we want another node with the capacity above it. For this,

we use the option `label=above:$s\le 3$`. This option is interpreted as follows: We want a node above the `semaphore` node and this node should read “ $s \leq 3$ .” Instead of `above` we could also use things like `below left` before the colon or a number like `60`.

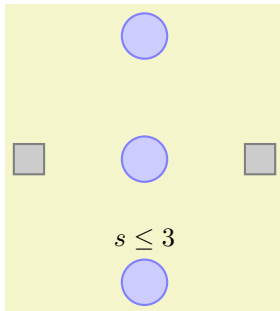

```
\begin{tikzpicture}
  \node[place]      (waiting)      {};
  \node[place]      (critical)     [below=of waiting] {};
  \node[place]      (semaphore)    [below=of critical,
                                     label=above:$s\le 3$] {};
  \node[transition] (leave critical) [right=of critical] {};
  \node[transition] (enter critical) [left=of critical]  {};
\end{tikzpicture}
```

It is also possible to give multiple `label` options, this causes multiple labels to be drawn.

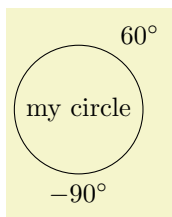

```
\tikz
  \node [circle,draw,label=60:$60^\circ\circ$,label=below:$-90^\circ\circ$] {my circle};
```

Hagen is not fully satisfied with the `label` option since the label is not red. To achieve this, he has two options: First, he can redefine the `every label` style. Second, he can add options to the label’s node. These options are given following the `label=`, so he would write `label=[red]above:$s\le 3$`. However, this does not quite work since  $\TeX$  thinks that the `]` closes the whole option list of the `semaphore` node. So, Hagen has to add braces and writes `label={ [red]above:$s\le 3$}`. Since this looks a bit ugly, Hagen decides to redefine the `every label` style.

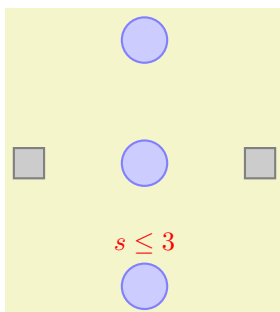

```
\begin{tikzpicture}[every label/.style={red}]
  \node[place]      (waiting)      {};
  \node[place]      (critical)     [below=of waiting] {};
  \node[place]      (semaphore)    [below=of critical,
                                     label=above:$s\le 3$] {};
  \node[transition] (leave critical) [right=of critical] {};
  \node[transition] (enter critical) [left=of critical]  {};
\end{tikzpicture}
```

### 3.10 Connecting Nodes

It is now high time to connect the nodes. Let us start with something simple, namely with the straight line from `enter critical` to `critical`. We want this line to start at the right side of `enter critical` and to end at the left side of `critical`. For this, we can use the *anchors* of the nodes. Every node defines a whole bunch of anchors that lie on its border or inside it. For example, the `center` anchor is at the center of the node, the `west` anchor is on the left of the node, and so on. To access the coordinate of a node, we use a coordinate that contains the node’s name followed by a dot, followed by the anchor’s name:

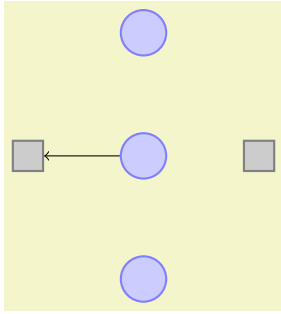

```
\begin{tikzpicture}
  \node[place]      (waiting)      {};
  \node[place]      (critical)     [below=of waiting] {};
  \node[place]      (semaphore)    [below=of critical] {};
  \node[transition] (leave critical) [right=of critical] {};
  \node[transition] (enter critical) [left=of critical]  {};
  \draw [->] (critical.west) -- (enter critical.east);
\end{tikzpicture}
```

Next, let us tackle the curve from `waiting` to `enter critical`. This can be specified using curves and controls:

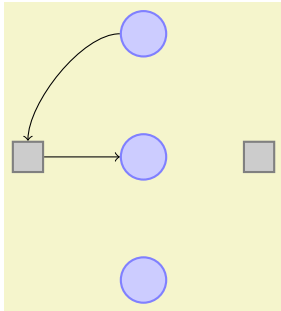

```
\begin{tikzpicture}
  \node[place]      (waiting)      {};
  \node[place]      (critical)     [below=of waiting] {};
  \node[place]      (semaphore)    [below=of critical] {};
  \node[transition] (leave critical) [right=of critical] {};
  \node[transition] (enter critical) [left=of critical]  {};
  \draw [->] (enter critical.east) -- (critical.west);
  \draw [->] (waiting.west) .. controls +(left:5mm) and +(up:5mm)
              .. (enter critical.north);
\end{tikzpicture}
```

Hagen sees how he can now add all his edges, but the whole process seems a bit awkward and not very flexible. Again, the code seems to obscure the structure of the graphic rather than showing it.

So, let us start improving the code for the edges. First, Hagen can leave out the anchors:

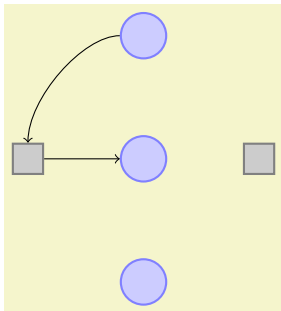

```
\begin{tikzpicture}
  \node[place]      (waiting)      {};
  \node[place]      (critical)     [below=of waiting] {};
  \node[place]      (semaphore)    [below=of critical] {};
  \node[transition] (leave critical) [right=of critical] {};
  \node[transition] (enter critical) [left=of critical]  {};
  \draw [->] (enter critical) -- (critical);
  \draw [->] (waiting) .. controls +(left:8mm) and +(up:8mm)
              .. (enter critical);
\end{tikzpicture}
```

Hagen is a bit surprised that this works. After all, how did *TikZ* know that the line from `enter critical` to `critical` should actually start on the borders? Whenever *TikZ* encounters a whole node name as a “coordinate,” it tries to “be smart” about the anchor that it should choose for this node. Depending on what happens next, *TikZ* will choose an anchor that lies on the border of the node on a line to the next coordinate or control point. The exact rules are a bit complex, but the chosen point will usually be correct – and when it is not, Hagen can still specify the desired anchor by hand.

Hagen would now like to simplify the curve operation somehow. It turns out that this can be accomplished using a special path operation: the `to` operation. This operation takes many options (you can even define new ones yourself). One pair of option is useful for Hagen: The pair `in` and `out`. These options take angles at which a curve should leave or reach the start or target coordinates. Without these options, a straight line is drawn:

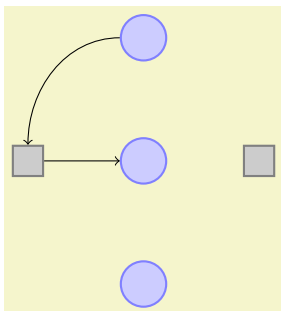

```
\begin{tikzpicture}
  \node[place]      (waiting)      {};
  \node[place]      (critical)     [below=of waiting] {};
  \node[place]      (semaphore)    [below=of critical] {};
  \node[transition] (leave critical) [right=of critical] {};
  \node[transition] (enter critical) [left=of critical]  {};
  \draw [->] (enter critical) to (critical);
  \draw [->] (waiting) to [out=180,in=90] (enter critical);
\end{tikzpicture}
```

There is another option for the `to` operation, that is even better suited to Hagen's problem: The `bend right` option. This option also takes an angle, but this angle only specifies the angle by which the curve is bend to the right:

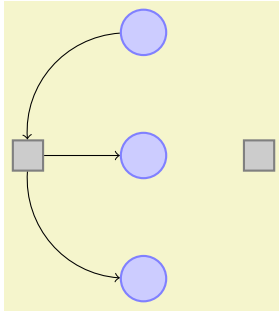

```
\begin{tikzpicture}
\node[place] (waiting) {};
\node[place] (critical) [below=of waiting] {};
\node[place] (semaphore) [below=of critical] {};
\node[transition] (leave critical) [right=of critical] {};
\node[transition] (enter critical) [left=of critical] {};
\draw [->] (enter critical) to (critical);
\draw [->] (waiting) to [bend right=45] (enter critical);
\draw [->] (critical) to [bend right=45] (semaphore);
\end{tikzpicture}
```

It is now time for Hagen to learn about yet another way of specifying edges: Using the `edge` path operation. This operation is very similar to the `to` operation, but there is one important difference: Like a node the edge generated by the `edge` operation is not part of the main path, but is added only later. This may not seem very important, but it has some nice consequences. For example, every edge can have its own arrow tips and its own color and so on and, still, all the edges can be given on the same path. This allows Hagen to write the following:

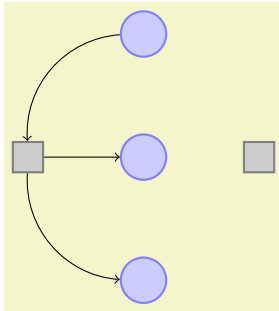

```
\begin{tikzpicture}
\node[place] (waiting) {};
\node[place] (critical) [below=of waiting] {};
\node[place] (semaphore) [below=of critical] {};
\node[transition] (leave critical) [right=of critical] {};
\node[transition] (enter critical) [left=of critical] {};
edge [->] (critical)
edge [<-,bend left=45] (waiting)
edge [->,bend right=45] (semaphore);
\end{tikzpicture}
```

Each `edge` caused a new path to be constructed, consisting of a `to` between the node `enter critical` and the node following the `edge` command.

The finishing touch is to introduce two styles `pre` and `post` and to use the `bend angle=45` option to set the bend angle once and for all:

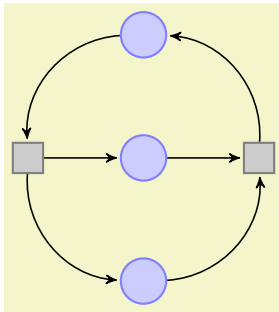

```
% Styles place and transition as before
\begin{tikzpicture}
[bend angle=45,
pre/.style={<-,shorten <=1pt,>=stealth',semithick},
post/.style={->,shorten >=1pt,>=stealth',semithick}]

\node[place] (waiting) {};
\node[place] (critical) [below=of waiting] {};
\node[place] (semaphore) [below=of critical] {};

\node[transition] (leave critical) [right=of critical] {}
edge [pre] (critical)
edge [post,bend right] (waiting)
edge [pre, bend left] (semaphore);
\node[transition] (enter critical) [left=of critical] {}
edge [post] (critical)
edge [pre, bend left] (waiting)
edge [post,bend right] (semaphore);
\end{tikzpicture}
```

### 3.11 Adding Labels Next to Lines

The next thing that Hagen needs to add is the "2" at the arcs. For this Hagen can use TikZ's automatic node placement: By adding the option `auto`, TikZ will position nodes on curves and lines in such a way that they are not on the curve but next to it. Adding `swap` will mirror the label with respect to the line. Here is a general example:



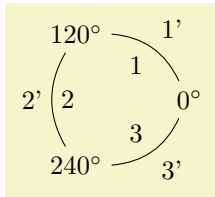

```
\begin{tikzpicture}[auto,bend right]
  \node (a) at (0:1) {$0^\circ$};
  \node (b) at (120:1) {$120^\circ$};
  \node (c) at (240:1) {$240^\circ$};

  \draw (a) to node [swap] {1'} (b)
        (b) to node [swap] {2'} (c)
        (c) to node [swap] {3'} (a);
\end{tikzpicture}
```

What is happening here? The nodes are given somehow inside the `to` operation! When this is done, the node is placed on the middle of the curve or line created by the `to` operation. The `auto` option then causes the node to be moved in such a way that it does not lie on the curve, but next to it. In the example we provide even two nodes on each `to` operation.

For Hagen that `auto` option is not really necessary since the two “2” labels could also easily be placed “by hand.” However, in a complicated plot with numerous edges automatic placement can be a blessing.

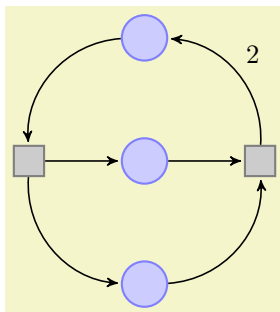

```
% Styles as before
\begin{tikzpicture}[bend angle=45]
  \node[place] (waiting) {};
  \node[place] (critical) [below=of waiting] {};
  \node[place] (semaphore) [below=of critical] {};

  \node[transition] (leave critical) [right=of critical] {}
  edge [pre] (critical)
  edge [post,bend right] node[auto,swap] {2} (waiting)
  edge [pre, bend left] (semaphore);
  \node[transition] (enter critical) [left=of critical] {}
  edge [post] (critical)
  edge [pre, bend left] (waiting)
  edge [post,bend right] (semaphore);
\end{tikzpicture}
```

### 3.12 Adding the Snaked Line and Multi-Line Text

With the node mechanism Hagen can now easily create the two Petri nets. What he is unsure of is how he can create the snaked line between the nets.

For this he can use a *decoration*. To draw the snake, Hagen only needs to set the two options `decoration=snake` and `decorate` on the path. This causes all lines of the path to be replaced by snakes. It is also possible to use snakes only in certain parts of a path, but Hagen will not need this.

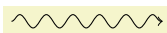

```
\begin{tikzpicture}
  \draw [->,decorate,decoration=snake] (0,0) -- (2,0);
\end{tikzpicture}
```

Well, that does not look quite right, yet. The problem is that the snake happens to end exactly at the position where the arrow begins. Fortunately, there is an option that helps here. Also, the snake should be a bit smaller, which can be influenced by even more options.

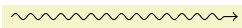

```
\begin{tikzpicture}
  \draw [->,decorate,
        decoration={snake,amplitude=.4mm,segment length=2mm,post length=1mm}]
        (0,0) -- (3,0);
\end{tikzpicture}
```

Now Hagen needs to add the text above the snake. This text is a bit challenging since it is a multi-line text. Hagen has two options for this: First, he can specify an `align=center` and then use the `\\` command to enforce the line breaks at the desired positions.

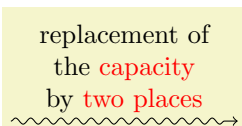

```
\begin{tikzpicture}
  \draw [->,decorate,
        decoration={snake,amplitude=.4mm,segment length=2mm,post length=1mm}]
        (0,0) -- (3,0)
  node [above,align=center,midway]
  {
    replacement of\\
    the \textcolor{red}{capacity}\\
    by \textcolor{red}{two places}
  };
\end{tikzpicture}
```



Instead of specifying the line breaks “by hand,” Hagen can also specify a width for the text and let  $\text{\TeX}$  perform the line breaking for him:

replacement of  
the **capacity**  
by **two places**  
~~~~~>

```
\begin{tikzpicture}
\draw [->,decorate,
decoration={snake,amplitude=.4mm,segment length=2mm,post length=1mm}]
(0,0) -- (3,0)
node [above,text width=3cm,align=center,midway]
{
replacement of the \textcolor{red}{capacity} by
\textcolor{red}{two places}
};
\end{tikzpicture}
```

### 3.13 Using Layers: The Background Rectangles

Hagen still needs to add the background rectangles. These are a bit tricky: Hagen would like to draw the rectangles *after* the Petri nets are finished. The reason is that only then can he conveniently refer to the coordinates that make up the corners of the rectangle. If Hagen draws the rectangle first, then he needs to know the exact size of the Petri net – which he does not.

The solution is to use *layers*. When the background library is loaded, Hagen can put parts of his picture inside a `{pgfonlayer}` environment. Then this part of the picture becomes part of the layer that is given as an argument to this environment. When the `{tikzpicture}` environment ends, the layers are put on top of each other, starting with the background layer. This causes everything drawn on the background layer to be behind the main text.

The next tricky question is, how big should the rectangle be? Naturally, Hagen can compute the size “by hand” or using some clever observations concerning the *x*- and *y*-coordinates of the nodes, but it would be nicer to just have *TikZ* compute a rectangle into which all the nodes “fit.” For this, the *fit* library can be used. It defines the *fit* options, which, when give to a node, causes the node to be resized and shifted such that it exactly covers all the nodes and coordinates given as parameters to the *fit* option.

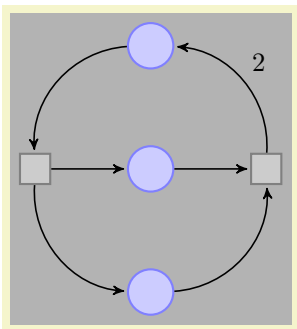

```
% Styles as before
\begin{tikzpicture}[bend angle=45]
\node[place] (waiting) {};
\node[place] (critical) [below=of waiting] {};
\node[place] (semaphore) [below=of critical] {};

\node[transition] (leave critical) [right=of critical] {}
edge [pre] (critical)
edge [post,bend right] node[auto,swap] {2} (waiting)
edge [pre, bend left] (semaphore);
\node[transition] (enter critical) [left=of critical] {}
edge [post] (critical)
edge [pre, bend left] (waiting)
edge [post,bend right] (semaphore);

\begin{pgfonlayer}{background}
\node [fill=black!30,fit=(waiting) (critical) (semaphore)
(leave critical) (enter critical)] {};
\end{pgfonlayer}
\end{tikzpicture}
```

### 3.14 The Complete Code

Hagen has now finally put everything together. Only then does he learn that there is already a library for drawing Petri nets! It turns out that this library mainly provides the same definitions as Hagen did. For example, it defines a *place* style in a similar way as Hagen did. Adjusting the code so that it uses the library shortens Hagen code a bit, as shown in the following.

First, Hagen needs less style definitions, but he still needs to specify the colors of places and transitions.

```
\begin{tikzpicture}
[node distance=1.3cm,on grid,>stealth',bend angle=45,auto,
every place/.style={minimum size=6mm,thick,draw=blue!75,fill=blue!20},
every transition/.style={thick,draw=black!75,fill=black!20},
red place/.style={place,draw=red!75,fill=red!20},
every label/.style={red}]
```

Now comes the code for the nets:

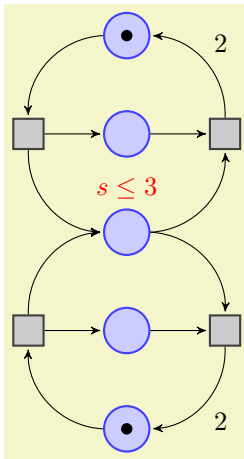

```

\node [place,tokens=1] (w1) {}
\node [place] (c1) [below=of w1] {}
\node [place] (s) [below=of c1,label=above:$s\le 3$] {}
\node [place] (c2) [below=of s] {}
\node [place,tokens=1] (w2) [below=of c2] {}

\node [transition] (e1) [left=of c1] {}
edge [pre,bend left] (w1)
edge [post,bend right] (s)
edge [post] (c1);
\node [transition] (e2) [left=of c2] {}
edge [pre,bend right] (w2)
edge [post,bend left] (s)
edge [post] (c2);
\node [transition] (l1) [right=of c1] {}
edge [pre] (c1)
edge [pre,bend left] (s)
edge [post,bend right] node[swap] {2} (w1);
\node [transition] (l2) [right=of c2] {}
edge [pre] (c2)
edge [pre,bend right] (s)
edge [post,bend left] node {2} (w2);

```

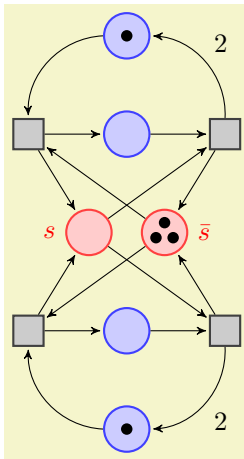

```

\begin{scope}[xshift=6cm]
\node [place,tokens=1] (w1') {}
\node [place] (c1') [below=of w1'] {}
\node [red place] (s1') [below=of c1',xshift=-5mm] {}
[red] [label=left:$s$]
\node [red place,tokens=3] (s2') [below=of c1',xshift=5mm] {}
[red] [label=right:$\bar{s}$]
\node [place] (c2') [below=of s1',xshift=5mm] {}
\node [place,tokens=1] (w2') [below=of c2'] {}

\node [transition] (e1') [left=of c1'] {}
edge [pre,bend left] (w1')
edge [post] (s1')
edge [pre] (s2')
edge [post] (c1');
\node [transition] (e2') [left=of c2'] {}
edge [pre,bend right] (w2')
edge [post] (s1')
edge [pre] (s2')
edge [post] (c2');
\node [transition] (l1') [right=of c1'] {}
edge [pre] (c1')
edge [pre] (s1')
edge [post] (s2')
edge [post,bend right] node[swap] {2} (w1');
\node [transition] (l2') [right=of c2'] {}
edge [pre] (c2')
edge [pre] (s1')
edge [post] (s2')
edge [post,bend left] node {2} (w2');
\end{scope}

```

The code for the background and the snake is the following:

```

\begin{pgfonlayer}{background}
\node (r1) [fill=black!10,rounded corners,fit=(w1)(w2)(e1)(e2)(l1)(l2)] {};
\node (r2) [fill=black!10,rounded corners,fit=(w1')(w2')(e1')(e2')(l1')(l2')] {};
\end{pgfonlayer}

\draw [shorten >=1mm,-to,thick,decorate,
decoration={snake,amplitude=.4mm,segment length=2mm,
pre=moveto,pre length=1mm,post length=2mm}]
(r1) -- (r2) node [above=1mm,midway,text width=3cm,align=center]
{replacement of the \textcolor{red}{capacity} by \textcolor{red}{two places}};
\end{tikzpicture}

```

## 4 Tutorial: Euclid’s Amber Version of the *Elements*

In this third tutorial we have a look at how TikZ can be used to draw geometric constructions.

Euclid is currently quite busy writing his new book series, whose working title is “Elements” (Euclid is not quite sure whether this title will convey the message of the series to future generations correctly, but he intends to change the title before it goes to the publisher). Up to know, he wrote down his text and graphics on papyrus, but his publisher suddenly insists that he must submit in electronic form. Euclid tries to argue with the publisher that electronics will only be discovered thousands of years later, but the publisher informs him that the use of papyrus is no longer cutting edge technology and Euclid will just have to keep up with modern tools.

Slightly disgruntled, Euclid starts converting his papyrus entitled “Book I, Proposition I” to an amber version.

### 4.1 Book I, Proposition I

The drawing on his papyrus looks like this:<sup>1</sup>

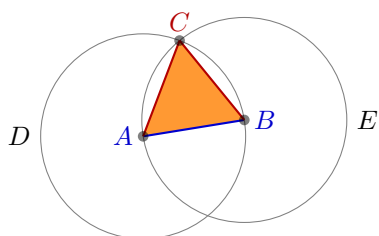

#### Proposition I

To construct an *equilateral triangle* on a given *finite straight line*.

Let  $AB$  be the given *finite straight line*. It is required to construct an *equilateral triangle* on the *straight line*  $AB$ .

Describe the circle  $BCD$  with center  $A$  and radius  $AB$ . Again describe the circle  $ACE$  with center  $B$  and radius  $BA$ . Join the *straight lines*  $CA$  and  $CB$  from the point  $C$  at which the circles cut one another to the points  $A$  and  $B$ .

Now, since the point  $A$  is the center of the circle  $CDB$ , therefore  $AC$  equals  $AB$ . Again, since the point  $B$  is the center of the circle  $CAE$ , therefore  $BC$  equals  $BA$ . But  $AC$  was proved equal to  $AB$ , therefore each of the straight lines  $AC$  and  $BC$  equals  $AB$ . And things which equal the same thing also equal one another, therefore  $AC$  also equals  $BC$ . Therefore the three straight lines  $AC$ ,  $AB$ , and  $BC$  equal one another. Therefore the *triangle*  $ABC$  is equilateral, and it has been constructed on the given finite *straight line*  $AB$ .

Let us have a look at how Euclid can turn this into TikZ code.

#### 4.1.1 Setting up the Environment

As in the previous tutorials, Euclid needs to load TikZ, together with some libraries. These libraries are `calc`, `intersections`, `through`, and `backgrounds`. Depending on which format he uses, Euclid would use one of the following in the preamble:

```
% For LaTeX:
\usepackage{tikz}
\usetikzlibrary{calc,intersections,through,backgrounds}
```

```
% For plain TeX:
\input tikz.tex
\usetikzlibrary{calc,intersections,through,backgrounds}
```

```
% For ConTeXt:
\usemodule[tikz]
\usetikzlibrary[calc,intersections,through,backgrounds]
```

<sup>1</sup>The text is taken from the wonderful interactive version of Euclid’s Elements by David E. Joyce, to be found on his website at Clark University.

### 4.1.2 The Line $AB$

The first part of the picture that Euclid wishes to draw is the line  $AB$ . That is easy enough, something like `\draw (0,0) -- (2,1);` might do. However, Euclid does not wish to reference the two points  $A$  and  $B$  as  $(0,0)$  and  $(2,1)$  subsequently. Rather, he wishes to just write  $A$  and  $B$ . Indeed, the whole point of his book is that the points  $A$  and  $B$  can be arbitrary and all other points (like  $C$ ) are constructed in terms of their positions. It would not do if Euclid were to write down the coordinates of  $C$  explicitly.

So, Euclid starts with defining two coordinates using the `\coordinate` command:



```
\begin{tikzpicture}
  \coordinate (A) at (0,0);
  \coordinate (B) at (1.25,0.25);

  \draw[blue] (A) -- (B);
\end{tikzpicture}
```

That was easy enough. What is missing at this point are the labels for the coordinates. Euclid does not want them *on* the points, but next to them. He decides to use the `label` option:

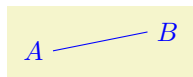

```
\begin{tikzpicture}
  \coordinate [label=left:\textcolor{blue}{A}] (A) at (0,0);
  \coordinate [label=right:\textcolor{blue}{B}] (B) at (1.25,0.25);

  \draw[blue] (A) -- (B);
\end{tikzpicture}
```

At this point, Euclid decides that it would be even nicer if the points  $A$  and  $B$  were in some sense “random.” Then, neither Euclid nor the reader can make the mistake of taking “anything for granted” concerning these position of these points. Euclid is pleased to learn that there is a `rand` function in `TikZ` that does exactly what he needs: It produces a number between  $-1$  and  $1$ . Since `TikZ` can do a bit of math, Euclid can change the coordinates of the points as follows:

```
\coordinate [...] (A) at (0+0.1*rand,0+0.1*rand);
\coordinate [...] (B) at (1.25+0.1*rand,0.25+0.1*rand);
```

This works fine. However, Euclid is not quite satisfied since he would prefer that the “main coordinates”  $(0,0)$  and  $(1.25,0.25)$  are “kept separate” from the perturbation  $0.1(\text{rand}, \text{rand})$ . This means, he would like to specify that coordinate  $A$  as “The point that is at  $(0,0)$  plus one tenth of the vector  $(\text{rand}, \text{rand})$ .”

It turns out that the `calc` library allows him to do exactly this kind of computation. When this library is loaded, you can use special coordinates that start with  $(\$$  and end with  $\$)$  rather than just  $($  and  $)$ . Inside these special coordinates you can give a linear combination of coordinates. (Note that the dollar signs are only intended to signal that a “computation” is going on; no mathematical typesetting is done.)

The new code for the coordinates is the following:

```
\coordinate [...] (A) at ($ (0,0) + .1*(rand,rand) $);
\coordinate [...] (B) at ($ (1.25,0.25) + .1*(rand,rand) $);
```

Note that if a coordinate in such a computation has a factor (like  $.1$ ) you must place a `*` directly before the opening parenthesis of the coordinate. You can nest such computations.

### 4.1.3 The Circle Around $A$

The first tricky construction is the circle around  $A$ . We will see later how to do this in a very simple manner, but first let us do it the “hard” way.

The idea is the following: We draw a circle around the point  $A$  whose radius is given by the length of the line  $AB$ . The difficulty lies in computing the length of this line.

Two ideas “nearly” solve this problem: First, we can write  $(\$ (A) - (B) \$)$  for the vector that is the difference between  $A$  and  $B$ . All we need is the length of this vector. Second, given two numbers  $x$  and  $y$ , one can write `veclen( $x,y$ )` inside a mathematical expression. This gives the value  $\sqrt{x^2 + y^2}$ , which is exactly the desired length.

The only remaining problem is to access the  $x$ - and  $y$ -coordinate of the vector  $AB$ . For this, we need a new concept: the *let operation*. A `let` operation can be given anywhere on a path where a normal path operation like a `line-to` or a `move-to` is expected. The effect of a `let` operation is to evaluate some coordinates and to assign the results to special macros. These macros make it easy to access the  $x$ - and  $y$ -coordinates of the coordinates.

Euclid would write the following:

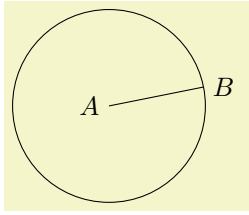

```

\begin{tikzpicture}
  \coordinate [label=left:$A$] (A) at (0,0);
  \coordinate [label=right:$B$] (B) at (1.25,0.25);
  \draw (A) -- (B);

  \draw (A) let
    \p1 = ($ (B) - (A) $)
    in
    circle ({veclen(\x1,\y1)});
\end{tikzpicture}

```

Each assignment in a let operation starts with `\p`, usually followed by a *digit*. Then comes an equal sign and a coordinate. The coordinate is evaluated and the result is stored internally. From then on you can use the following expressions:

1. `\x<digit>` yields the  $x$ -coordinate of the resulting point.
2. `\y<digit>` yields the  $y$ -coordinate of the resulting point.
3. `\p<digit>` yields the same as `\x<digit>`, `\y<digit>`.

You can have multiple assignments in a let operation, just separate them with commas. In later assignments you can already use the results of earlier assignments.

Note that `\p1` is not a coordinate in the usual sense. Rather, it just expands to a string like `10pt,20pt`. So, you cannot write, for instance, `(\p1.center)` since this would just expand to `(10pt,20pt.center)`, which makes no sense.

Next, we want to draw both circles at the same time. Each time the radius is `veclen(\x1,\y1)`. It seems natural to compute this radius only once. For this, we can also use a let operation: Instead of writing `\p1 = ...`, we write `\n2 = ...`. Here, “n” stands for “number” (while “p” stands for “point”). The assignment of a number should be followed by a number in curly braces.

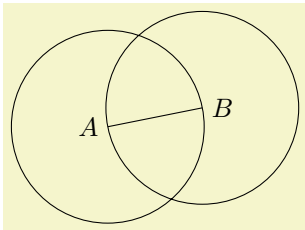

```

\begin{tikzpicture}
  \coordinate [label=left:$A$] (A) at (0,0);
  \coordinate [label=right:$B$] (B) at (1.25,0.25);
  \draw (A) -- (B);

  \draw let \p1 = ($ (B) - (A) $),
    \n2 = {veclen(\x1,\y1)}
  in
    (A) circle (\n2)
    (B) circle (\n2);
\end{tikzpicture}

```

In the above example, you may wonder, what `\n1` would yield? The answer is that it would be undefined – the `\p`, `\x`, and `\y` macros refer to the same logical point, while the `\n` macro has “its own namespace.” We could even have replaced `\n2` in the example by `\n1` and it would still work. Indeed, the digits following these macros are just normal  $\text{\TeX}$  parameters. We could also use a longer name, but then we have to use curly braces:

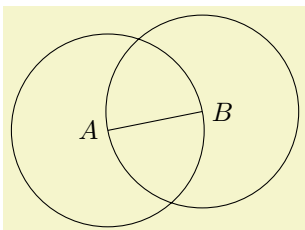

```

\begin{tikzpicture}
  \coordinate [label=left:$A$] (A) at (0,0);
  \coordinate [label=right:$B$] (B) at (1.25,0.25);
  \draw (A) -- (B);

  \draw let \p1 = ($ (B) - (A) $),
    \n{radius} = {veclen(\x1,\y1)}
  in
    (A) circle (\n{radius})
    (B) circle (\n{radius});
\end{tikzpicture}

```

At the beginning of this section it was promised that there is an easier way to create the desired circle. The trick is to use the `through` library. As the name suggests, it contains code for creating shapes that go through a given point.

The option that we are looking for is `circle through`. This option is given to a *node* and has the following effects: First, it causes the node’s inner and outer separations to be set to zero. Then it sets the shape of the node to `circle`. Finally, it sets the radius of the node such that it goes through the parameter given to `circle through`. This radius is computed in essentially the same way as above.

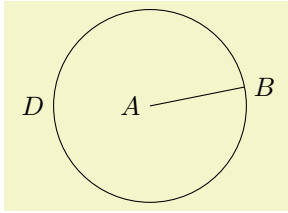

```

\begin{tikzpicture}
  \coordinate [label=left:$A$] (A) at (0,0);
  \coordinate [label=right:$B$] (B) at (1.25,0.25);
  \draw (A) -- (B);

  \node [draw,circle through=(B),label=left:$D$] at (A) {};
\end{tikzpicture}

```

#### 4.1.4 The Intersection of the Circles

Euclid can now draw the line and the circles. The final problem is to compute the intersection of the two circles. This computation is a bit involved if you want to do it “by hand.” Fortunately, the intersection library allows us to compute the intersection of arbitrary paths.

The idea is simple: First, you “name” two paths using the `name path` option. Then, at some later point, you can use the option `name intersections`, which creates coordinates called `intersection-1`, `intersection-2`, and so on at all intersections of the paths. Euclid assigns the names `D` and `E` to the paths of the two circles (which happen to be the same names as the nodes themselves, but nodes and their paths live in different “namespaces”).

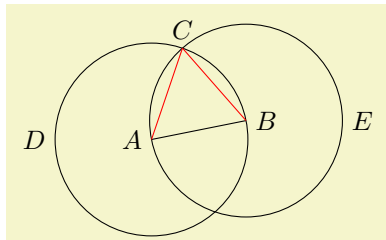

```

\begin{tikzpicture}
  \coordinate [label=left:$A$] (A) at (0,0);
  \coordinate [label=right:$B$] (B) at (1.25,0.25);
  \draw (A) -- (B);

  \node (D) [name path=D,draw,circle through=(B),label=left:$D$] at (A) {};
  \node (E) [name path=E,draw,circle through=(A),label=right:$E$] at (B) {};

  % Name the coordinates, but do not draw anything:
  \path [name intersections={of=D and E}];

  \coordinate [label=above:$C$] (C) at (intersection-1);

  \draw [red] (A) -- (C);
  \draw [red] (B) -- (C);
\end{tikzpicture}

```

It turns out that this can be further shortened: The `name intersections` takes an optional argument `by`, which lets you specify names for the coordinates and options for them. This creates more compact code. Although Euclid does not need it for the current picture, it is just a small step to computing the bisection of the line  $AB$ :

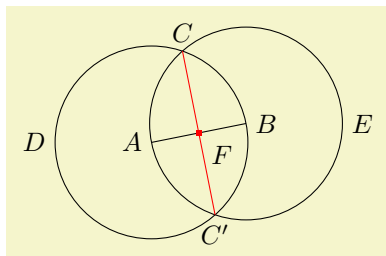

```

\begin{tikzpicture}
  \coordinate [label=left:$A$] (A) at (0,0);
  \coordinate [label=right:$B$] (B) at (1.25,0.25);
  \draw [name path=A--B] (A) -- (B);

  \node (D) [name path=D,draw,circle through=(B),label=left:$D$] at (A) {};
  \node (E) [name path=E,draw,circle through=(A),label=right:$E$] at (B) {};

  \path [name intersections={of=D and E, by={ [label=above:$C$]C, [label=below:$C'$]C' }}];

  \draw [name path=C--C',red] (C) -- (C');

  \path [name intersections={of=A--B and C--C',by=F}];
  \node [fill=red,inner sep=1pt,label=-45:$F$] at (F) {};
\end{tikzpicture}

```

#### 4.1.5 The Complete Code

Back to Euclid's code. He introduces a few macros to make life simpler, like a `\A` macro for typesetting a blue  $A$ . He also uses the background layer for drawing the triangle behind everything at the end.

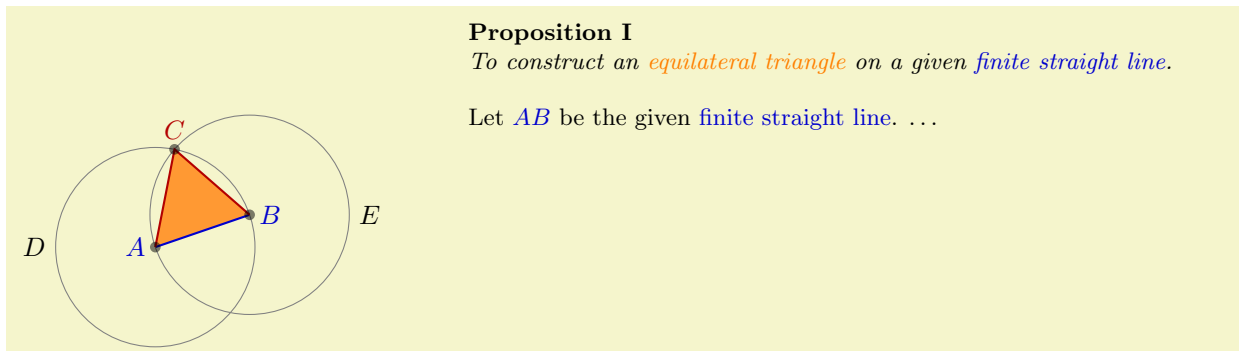

```

\begin{tikzpicture}[thick,help lines/.style={thin,draw=black!50}]
  \def\A{\textcolor{input}{$A$}}      \def\B{\textcolor{input}{$B$}}
  \def\C{\textcolor{output}{$C$}}    \def\D{$D$}
  \def\E{$E$}

  \colorlet{input}{blue!80!black}    \colorlet{output}{red!70!black}
  \colorlet{triangle}{orange}

  \coordinate [label=left:\A] (A) at ($ (0,0) + .1*(rand,rand) $);
  \coordinate [label=right:\B] (B) at ($ (1.25,0.25) + .1*(rand,rand) $);

  \draw [input] (A) -- (B);

  \node [name path=D,help lines,draw,label=left:\D] (D) at (A) [circle through=(B)] {};
  \node [name path=E,help lines,draw,label=right:\E] (E) at (B) [circle through=(A)] {};

  \path [name intersections={of=D and E,by={ [label=above:\C]C }}];

  \draw [output] (A) -- (C) -- (B);

  \foreach \point in {A,B,C}
    \fill [black,opacity=.5] (\point) circle (2pt);

  \begin{pgfonlayer}{background}
    \fill[triangle!80] (A) -- (C) -- (B) -- cycle;
  \end{pgfonlayer}

  \node [below right, text width=10cm,align=justify] at (4,3) {
    \small\textbf{Proposition I}\par
    \emph{To construct an \textcolor{triangle}{equilateral triangle}
      on a given \textcolor{input}{finite straight line}.}
    \par\vskip1em
    Let \A\B be the given \textcolor{input}{finite straight line}. \dots
  };
\end{tikzpicture}

```



## 4.2 Book I, Proposition II

The second proposition in the Elements is the following:

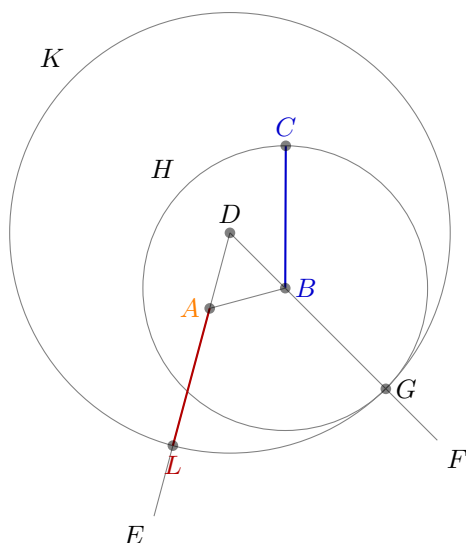

### Proposition II

To place a *straight line* equal to a given *straight line* with one end at a *given point*.

Let  $A$  be the given point, and  $BC$  the given *straight line*. It is required to place a *straight line* equal to the given *straight line*  $BC$  with one end at the point  $A$ .

Join the *straight line*  $AB$  from the point  $A$  to the point  $B$ , and construct the equilateral triangle  $DAB$  on it.

Produce the *straight lines*  $AE$  and  $BF$  in a *straight line* with  $DA$  and  $DB$ . Describe the circle  $CGH$  with center  $B$  and radius  $BC$ , and again, describe the circle  $GKL$  with center  $D$  and radius  $DG$ .

Since the point  $B$  is the center of the circle  $CGH$ , therefore  $BC$  equals  $BG$ . Again, since the point  $D$  is the center of the circle  $GKL$ , therefore  $DL$  equals  $DG$ . And in these  $DA$  equals  $DB$ , therefore the remainder  $AL$  equals the remainder  $BG$ . But  $BC$  was also proved equal to  $BG$ , therefore each of the *straight lines*  $AL$  and  $BC$  equals  $BG$ . And things which equal the same thing also equal one another, therefore  $AL$  also equals  $BC$ .

Therefore the *straight line*  $AL$  equal to the given *straight line*  $BC$  has been placed with one end at the *given point*  $A$ .

### 4.2.1 Using Partway Calculations for the Construction of $D$

Euclid's construction starts with "referencing" Proposition I for the construction of the point  $D$ . Now, while we could simply repeat the construction, it seems a bit bothersome that one has to draw all these circles and do all these complicated constructions.

For this reason, TikZ supports some simplifications. First, there is a simple syntax for computing a point that is "partway" on a line from  $p$  to  $q$ : You place these two points in a coordinate calculation – remember, they start with (\$) and end with (\$) – and then combine them using !*part*!. A *part* of 0 refers to the *first* coordinate, a *part* of 1 refers to the second coordinate, and a value in between refers to a point on the line from  $p$  to  $q$ . Thus, the syntax is similar to the xcolor syntax for mixing colors.

Here is the computation of the point in the middle of the line  $AB$ :

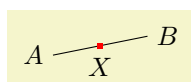

```
\begin{tikzpicture}
  \coordinate [label=left:$A$] (A) at (0,0);
  \coordinate [label=right:$B$] (B) at (1.25,0.25);
  \draw (A) -- (B);
  \node [fill=red,inner sep=1pt,label=below:$X$] (X) at ($(A)!.5!(B)$) {};
\end{tikzpicture}
```

The computation of the point  $D$  in Euclid's second proposition is a bit more complicated. It can be expressed as follows: Consider the line from  $X$  to  $B$ . Suppose we rotate this line around  $X$  for  $90^\circ$  and then stretch it by a factor of  $\sin(60^\circ)/2$ . This yields the desired point  $D$ . We can do the stretching using the partway modifier above, for the rotation we need a new modifier: the rotation modifier. The idea is that the second coordinate in a partway computation can be prefixed by an angle. Then the partway point is computed normally (as if no angle were given), but the resulting point is rotated by this angle around the first point.

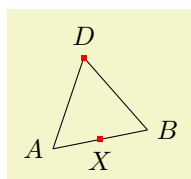

```
\begin{tikzpicture}
  \coordinate [label=left:$A$] (A) at (0,0);
  \coordinate [label=right:$B$] (B) at (1.25,0.25);
  \draw (A) -- (B);
  \node [fill=red,inner sep=1pt,label=below:$X$] (X) at ($(A)!.5!(B)$) {};
  \node [fill=red,inner sep=1pt,label=above:$D$] (D) at
    ($X)!\{\sin(60)*2\}!90:(B)$) {};
  \draw (A) -- (D) -- (B);
\end{tikzpicture}
```

Finally, it is not necessary to explicitly name the point  $X$ . Rather, again like in the xcolor package, it is possible to chain partway modifiers:



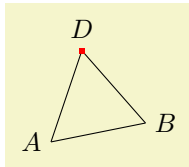

```
\begin{tikzpicture}
\coordinate [label=left:$A$] (A) at (0,0);
\coordinate [label=right:$B$] (B) at (1.25,0.25);
\draw (A) -- (B);
\node [fill=red,inner sep=1pt,label=above:$D$] (D) at
($ (A) ! .5 ! (B) ! {\sin(60)*2} ! 90:(B) $) {};
\draw (A) -- (D) -- (B);
\end{tikzpicture}
```

#### 4.2.2 Intersecting a Line and a Circle

The next step in the construction is to draw a circle around  $B$  through  $C$ , which is easy enough to do using the `circle through` option. Extending the lines  $DA$  and  $DB$  can be done using partway calculations, but this time with a part value outside the range  $[0, 1]$ :

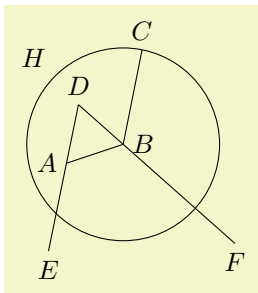

```
\begin{tikzpicture}
\coordinate [label=left:$A$] (A) at (0,0);
\coordinate [label=right:$B$] (B) at (0.75,0.25);
\coordinate [label=above:$C$] (C) at (1,1.5);
\draw (A) -- (B) -- (C);
\coordinate [label=above:$D$] (D) at
($ (A) ! .5 ! (B) ! {\sin(60)*2} ! 90:(B) $) {};
\node (H) [label=135:$H$,draw,circle through=(C)] at (B) {};
\draw (D) -- ($ (D) ! 3.5 ! (B) $) coordinate [label=below:$F$] (F);
\draw (D) -- ($ (D) ! 2.5 ! (A) $) coordinate [label=below:$E$] (E);
\end{tikzpicture}
```

We now face the problem of finding the point  $G$ , which is the intersection of the line  $BF$  and the circle  $H$ . One way is to use yet another variant of the partway computation: Normally, a partway computation has the form  $\langle p \rangle ! \langle factor \rangle ! \langle q \rangle$ , resulting in the point  $(1 - \langle factor \rangle) \langle p \rangle + \langle factor \rangle \langle q \rangle$ . Alternatively, instead of  $\langle factor \rangle$  you can also use a  $\langle dimension \rangle$  between the points. In this case, you get the point that is  $\langle dimension \rangle$  removed from  $\langle p \rangle$  on the straight line to  $\langle q \rangle$ .

We know that the point  $G$  is on the way from  $B$  to  $F$ . The distance is given by the radius of the circle  $H$ . Here is the code form computing  $H$ :

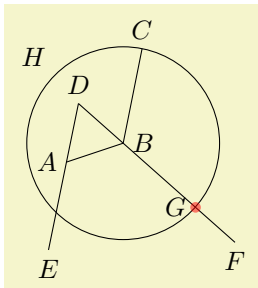

```
\node (H) [label=135:$H$,draw,circle through=(C)] at (B) {};
\path let \p1 = ($ (B) - (C) $) in
coordinate [label=left:$G$] (G) at ($ (B) ! vecLen(\x1,\y1) ! (F) $);
\fill[red,opacity=.5] (G) circle (2pt);
```

However, there is a simpler way: We can simply name the path of the circle and of the line in question and then use `name intersections` to compute the intersections.

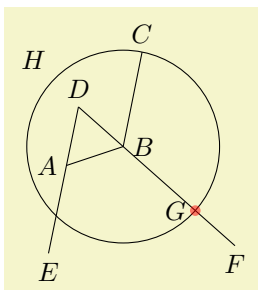

```
\node (H) [name path=H,label=135:$H$,draw,circle through=(C)] at (B) {};
\path [name path=B--F] (B) -- (F);
\path [name intersections={of=H and B--F,by={label=left:$G$}G}];
\fill[red,opacity=.5] (G) circle (2pt);
```

### 4.2.3 The Complete Code

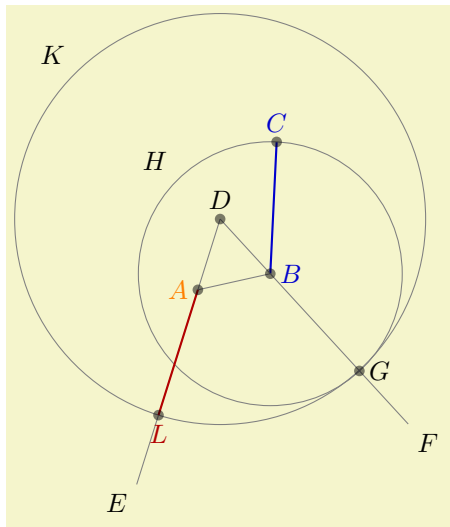

```

\begin{tikzpicture}[thick,help lines/.style={thin,draw=black!50}]
  \def\A{\textcolor{orange}{A}} \def\B{\textcolor{input}{B}}
  \def\C{\textcolor{input}{C}} \def\D{D}
  \def\E{E} \def\F{F}
  \def\G{G} \def\H{H}
  \def\K{K} \def\L{\textcolor{output}{L}}

  \colorlet{input}{blue!80!black} \colorlet{output}{red!70!black}

  \coordinate [label=left:\A] (A) at ($ (0,0) + .1*(rand,rand) $);
  \coordinate [label=right:\B] (B) at ($ (1,0.2) + .1*(rand,rand) $);
  \coordinate [label=above:\C] (C) at ($ (1,2) + .1*(rand,rand) $);

  \draw [input] (B) -- (C);
  \draw [help lines] (A) -- (B);

  \coordinate [label=above:\D] (D) at ($ (A)!.5!(B) ! {\sin(60)*2} ! 90:(B) $);

  \draw [help lines] (D) -- ($ (D)!3.75!(A) $) coordinate [label=-135:\E] (E);
  \draw [help lines] (D) -- ($ (D)!3.75!(B) $) coordinate [label=-45:\F] (F);

  \node (H) at (B) [name path=H,help lines,circle through=(C),draw,label=135:\H] {};
  \path [name path=B--F] (B) -- (F);
  \path [name intersections={of=H and B--F,by={ [label=right:\G] }}];

  \node (K) at (D) [name path=K,help lines,circle through=(G),draw,label=135:\K] {};
  \path [name path=A--E] (A) -- (E);
  \path [name intersections={of=K and A--E,by={ [label=below:\L] }}];

  \draw [output] (A) -- (L);

  \foreach \point in {A,B,C,D,G,L}
    \fill [black,opacity=.5] (\point) circle (2pt);

  % \node ...
\end{tikzpicture}

```

## 5 Tutorial: Putting a Diagram in Chains

In this tutorial we have a look at how chains and matrices can be used to typeset a diagram.

Ilka, who just got tenure for her professorship on Old and Lovable Programming Languages, has recently dug up a technical report entitled *The Programming Language Pascal* in the dusty cellar of the library of her university. Having been created in the good old times using pens and rules, it looks like this<sup>2</sup>:

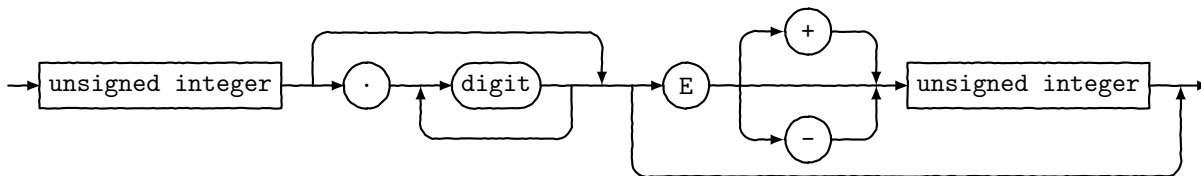

For her next lecture, Ilka decides to redo this diagram, but this time perhaps a bit cleaner and perhaps also bit “cooler.”

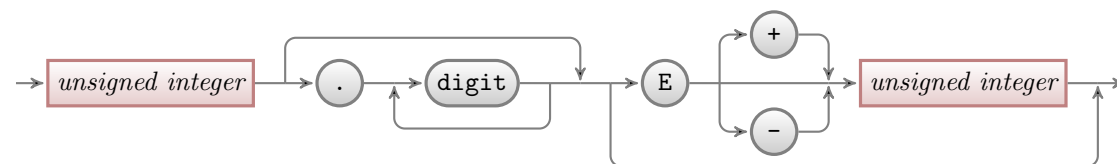

Having read the previous tutorials, Ilka knows already how to setup the environment for her diagram, namely using a `tikzpicture` environment. She wonders which libraries she will need. She decides that she will postpone the decision and add the necessary libraries as needed as she constructs the picture.

### 5.1 Styling the Nodes

The bulk of this tutorial will be about arranging the nodes and connecting them using chains, but let us start with setting up styles for the nodes.

There are two kinds of nodes in the diagram, namely what theoreticians like to call *terminals* and *nonterminals*. For the terminals, Ilka decides to use a black color, which visually shows that “nothing needs to be done about them.” The nonterminals, which still need to be “processed” further, get a bit of red mixed in.

Ilka starts with the simpler nonterminals, as there are no rounded corners involved. Naturally, she sets up a style:

*unsigned integer*

```
\begin{tikzpicture}[
  nonterminal/.style={
    % The shape:
    rectangle,
    % The size:
    minimum size=6mm,
    % The border:
    very thick,
    draw=red!50!black!50,           % 50% red and 50% black,
                                   % and that mixed with 50% white
    % The filling:
    top color=white,               % a shading that is white at the top...
    bottom color=red!50!black!20, % and something else at the bottom
    % Font
    font=\itshape
  }
]
\node [nonterminal] {unsigned integer};
\end{tikzpicture}
```

Ilka is pretty proud of the use of the `minimum size` option: As the name suggests, this option ensures that the node is at least 6mm by 6mm, but it will expand in size as necessary to accommodate longer text. By giving this option to all nodes, they will all have the same height of 6mm.

Styling the terminals is a bit more difficult because of the round corners. Ilka has several options how she can achieve them. One way is to use the `rounded corners` option. It gets a dimension as parameter and causes all corners to be replaced by little arcs with the given dimension as radius. By setting the radius

<sup>2</sup>The shown diagram was not scanned, but rather typeset using TikZ. The jittering lines were created using the `random steps` decoration.

to 3mm, she will get exactly what she needs: circles, when the shapes are, indeed, exactly 6mm by 6mm and otherwise half circles on the sides:



```
\begin{tikzpicture}[node distance=5mm,
                    terminal/.style={
                        % The shape:
                        rectangle,minimum size=6mm,rounded corners=3mm,
                        % The rest
                        very thick,draw=black!50,
                        top color=white,bottom color=black!20,
                        font=\ttfamily}]
\node (dot) [terminal] {.};
\node (digit) [terminal,right=of dot] {digit};
\node (E) [terminal,right=of digit] {E};
\end{tikzpicture}
```

Another possibility is to use a shape that is specially made for typesetting rectangles with arcs on the sides (she has to use the `shapes.misc` library to use it). This shape gives Ilka much more control over the appearance. For instance, she could have an arc only on the left side, but she will not need this.



```
\begin{tikzpicture}[node distance=5mm,
                    terminal/.style={
                        % The shape:
                        rounded rectangle,
                        minimum size=6mm,
                        % The rest
                        very thick,draw=black!50,
                        top color=white,bottom color=black!20,
                        font=\ttfamily}]
\node (dot) [terminal] {.};
\node (digit) [terminal,right=of dot] {digit};
\node (E) [terminal,right=of digit] {E};
\end{tikzpicture}
```

At this point, she notices a problem. The baseline of the text in the nodes is not aligned:



```
\begin{tikzpicture}[node distance=5mm]
\node (dot) [terminal] {.};
\node (digit) [terminal,right=of dot] {digit};
\node (E) [terminal,right=of digit] {E};

\draw [help lines] let \p1 = (dot.base),
                      \p2 = (digit.base),
                      \p3 = (E.base)
                      in (-.5,\y1) -- (3.5,\y1)
                        (-.5,\y2) -- (3.5,\y2)
                        (-.5,\y3) -- (3.5,\y3);
\end{tikzpicture}
```

(Ilka has moved the style definition to the preamble by saying `\tikzset{terminal/.style=...}`, so that she can use it in all pictures.)

For the `digit` and the `E` the difference in the baselines is almost imperceptible, but for the dot the problem is quite severe: It looks more like a multiplication dot than a period.

Ilka toys with the idea of using the `base right=of...` option rather than `right=of...` to align the nodes in such a way that the baselines are all on the same line (the `base right` option places a node right of something so that the baseline is right of the baseline of the other object). However, this does not have the desired effect:



```
\begin{tikzpicture}[node distance=5mm]
\node (dot) [terminal] {.};
\node (digit) [terminal,base right=of dot] {digit};
\node (E) [terminal,base right=of digit] {E};
\end{tikzpicture}
```

The nodes suddenly “dance around”! There is no hope of changing the position of text inside a node using anchors. Instead, Ilka must use a trick: The problem of mismatching baselines is caused by the fact that `.` and `digit` and `E` all have different heights and depth. If they all had the same, they would all be positioned vertically in the same manner. So, all Ilka needs to do is to use the `text height` and `text depth` options to explicitly specify a height and depth for the nodes.



```
\begin{tikzpicture}[node distance=5mm,
                    text height=1.5ex,text depth=.25ex]
  \node (dot) [terminal] {\.};
  \node (digit) [terminal,right=of dot] {digit};
  \node (E) [terminal,right=of digit] {E};
\end{tikzpicture}
```

## 5.2 Aligning the Nodes Using Positioning Options

Ilka now has the “styling” of the nodes ready. The next problem is to place them in the right places. There are several ways to do this. The most straightforward is to simply explicitly place the nodes at certain coordinates “calculated by hand.” For very simple graphics this is perfectly alright, but it has several disadvantages:

1. For more difficult graphics, the calculation may become complicated.
2. Changing the text of the nodes may make it necessary to recalculate the coordinates.
3. The source code of the graphic is not very clear since the relationships between the positions of the nodes are not made explicit.

For these reasons, Ilka decides to try out different ways of arranging the nodes on the page.

The first method is the use of *positioning options*. To use them, you need to load the `positioning` library. This gives you access to advanced implementations of options like `above` or `left`, since you can now say `above=of some node` in order to place a node above of `some node`, with the borders separated by `node distance`.

Ilka can use this to draw the place the nodes in a long row:

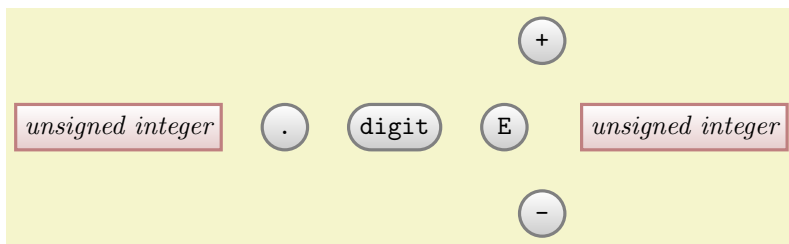

```
\begin{tikzpicture}[node distance=5mm and 5mm]
  \node (ui1) [nonterminal] {unsigned integer};
  \node (dot) [terminal,right=of ui1] {\.};
  \node (digit) [terminal,right=of dot] {digit};
  \node (E) [terminal,right=of digit] {E};
  \node (plus) [terminal,above right=of E] {+};
  \node (minus) [terminal,below right=of E] {-};
  \node (ui2) [nonterminal,below right=of plus] {unsigned integer};
\end{tikzpicture}
```

For the plus and minus nodes, Ilka is a bit startled by their placements. Shouldn't they be more to the right? The reason they are placed in that manner is the following: The **north east** anchor of the `E` node lies at the “upper start of the right arc,” which, a bit unfortunately in this case, happens to be the top of the node. Likewise, the **south west** anchor of the `+` node is actually at its bottom and, indeed, the horizontal and vertical distances between the top of the `E` node and the bottom of the `+` node are both 5mm.

There are several ways of fixing this problem. The easiest way is to simply add a little bit of horizontal shift by hand:

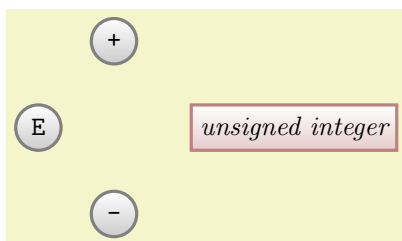

```

\begin{tikzpicture}[node distance=5mm and 5mm]
  \node (E) [terminal] {E};
  \node (plus) [terminal,above right=of E,xshift=5mm] {+};
  \node (minus) [terminal,below right=of E,xshift=5mm] {-};
  \node (ui2) [nonterminal,below right=of plus,xshift=5mm] {unsigned integer};
\end{tikzpicture}

```

A second way is to revert back to the idea of using a normal rectangle for the terminals, but with rounded corners. Since corner rounding does not affect anchors, she gets the following result:

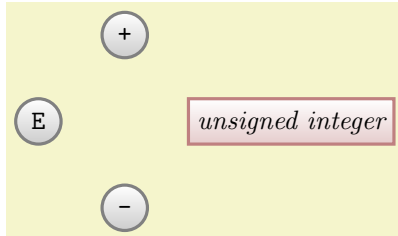

```

\begin{tikzpicture}[node distance=5mm and 5mm,terminal/.append style={rectangle,rounded corners=3mm}]
  \node (E) [terminal] {E};
  \node (plus) [terminal,above right=of E] {+};
  \node (minus) [terminal,below right=of E] {-};
  \node (ui2) [nonterminal,below right=of plus] {unsigned integer};
\end{tikzpicture}

```

A third way is to use matrices, which we will do later.

Now that the nodes have been placed, Ilka needs to add connections. Here, some connections are more difficult than other. Consider for instance the “repeat” line around the digit. One way of describing this line is to say “it starts a little to the right of digit than goes down and then goes to the left and finally ends at a point a little to the left of digit.” Ilka can put this into code as follows:



```

\begin{tikzpicture}[node distance=5mm and 5mm]
  \node (dot) [terminal] {.};
  \node (digit) [terminal,right=of dot] {digit};
  \node (E) [terminal,right=of digit] {E};

  \path (dot) edge[->] (digit) % simple edges
        (digit) edge[->] (E);

  \draw [->]
    % start right of digit.east, that is, at the point that is the
    % linear combination of digit.east and the vector (2mm,0pt). We
    % use the ($ ... $) notation for computing linear combinations
    ($ (digit.east) + (2mm,0) $)
    % Now go down
    -- ++(0,-.5)
    % And back to the left of digit.west
    -| ($ (digit.west) - (2mm,0) $);
\end{tikzpicture}

```

Since Ilka needs this “go up/down then horizontally and then up/down to a target” several times, it seems sensible to define a special *to-path* for this. Whenever the `edge` command is used, it simply adds the current value of `to path` to the path. So, Ilka can setup a style that contains the correct path:



```

\begin{tikzpicture}[node distance=5mm and 5mm,
  skip loop/.style={to path={-- ++(0,-.5) -| (\tikztotarget)}}]
  \node (dot) [terminal] {.};
  \node (digit) [terminal,right=of dot] {digit};
  \node (E) [terminal,right=of digit] {E};

  \path (dot) edge[->] (digit) % simple edges
        (digit) edge[->] (E)
        ($ (digit.east) + (2mm,0) $)
        edge[->,skip loop] ($ (digit.west) - (2mm,0) $);
\end{tikzpicture}

```

Ilka can even go a step further and make her `skip loop` style parametrized. For this, the `skip loop`’s vertical offset is passed as parameter #1. Also, in the following code Ilka specifies the start and targets differently, namely as the positions that are “in the middle between the nodes.”

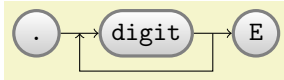

```
\begin{tikzpicture}[node distance=5mm and 5mm,
  skip loop/.style={to path={-- ++(0,#1) -| (\tikztotarget)}}]
  \node (dot) [terminal] {\.};
  \node (digit) [terminal,right=of dot] {digit};
  \node (E) [terminal,right=of digit] {E};

  \path (dot) edge[->] (digit) % simple edges
  (digit) edge[->] (E)
  ($ (digit.east)!.5!(E.west) $)
  edge[->,skip loop=-5mm] ($ (digit.west)!.5!(dot.east) $);
\end{tikzpicture}
```

### 5.3 Aligning the Nodes Using Matrices

Ilka is still bothered a bit by the placement of the plus and minus nodes. Somehow, having to add an explicit `xshift` seems too much like cheating.

A perhaps better way of positioning the nodes is to use a *matrix*. In TikZ matrices can be used to align quite arbitrary graphical objects in rows and columns. The syntax is very similar to the use of arrays and tables in T<sub>E</sub>X (indeed, internally T<sub>E</sub>X tables are used, but a lot of stuff is going on additionally).

In Ilka's graphic, there will be three rows: One row containing only the plus node, one row containing the main nodes and one row containing only the minus node.

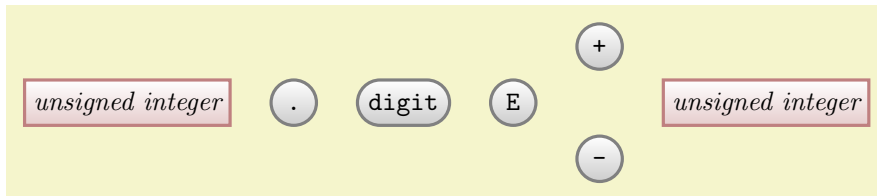

```
\begin{tikzpicture}
  \matrix[row sep=1mm,column sep=5mm] {
    % First row:
    & & & \node [terminal] {+}; & \\
    % Second row:
    \node [nonterminal] {unsigned integer}; & & & & \\
    \node [terminal] {\.}; & & & & \\
    \node [terminal] {digit}; & & & & \\
    \node [terminal] {E}; & & & & \\
    & & & & \\
    \node [nonterminal] {unsigned integer}; & & & & \\
    % Third row:
    & & & \node [terminal] {-}; & \\
  };
\end{tikzpicture}
```

That was easy! By toying around with the row and columns separations, Ilka can achieve all sorts of pleasing arrangements of the nodes.

Ilka now faces the same connecting problem as before. This time, she has an idea: She adds small nodes (they will be turned into coordinates later on and be invisible) at all the places where she would like connections to start and end.

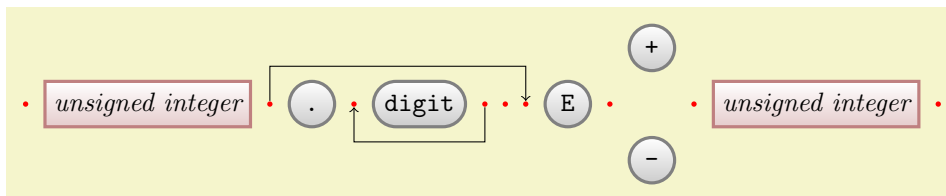





```

\begin{tikzpicture}[start chain,node distance=5mm, every node/.style={on chain,join}, every join/.style={->}]
  \node [nonterminal] {unsigned integer};
  \node [terminal] {\.};
  \node [terminal] {digit};
  \node [terminal] {E};
  \node [nonterminal] {unsigned integer};
\end{tikzpicture}

```

### 5.4.2 Branching and Joining a Chain

It is now time to add the plus and minus signs. They obviously *branch off* the main chain. For this reason, we start a branch for them using the `start branch` option.

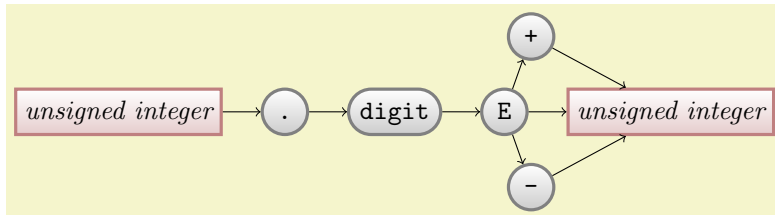

```

\begin{tikzpicture}[start chain,node distance=5mm, every node/.style={on chain,join}, every join/.style={->}]
  \node [nonterminal] {unsigned integer};
  \node [terminal] {\.};
  \node [terminal] {digit};
  \node [terminal] {E};
  \begin{scope}[start branch=plus]
    \node (plus) [terminal,on chain=going above right] {+};
  \end{scope}
  \begin{scope}[start branch=minus]
    \node (minus) [terminal,on chain=going below right] {-};
  \end{scope}
  \node [nonterminal,join=with plus,join=with minus] {unsigned integer};
\end{tikzpicture}

```

Let us see, what is going on here. First, the `start branch` begins a branch, starting with the node last created on the current chain, which is the `E` node in our case. This is implicitly also the first node on this branch. A branch is nothing different from a chain, which is why the plus node is put on this branch using the `on chain` option. However, this time we specify the placement of the node explicitly using `going <direction>`. This causes the plus sign to be placed above and right of the `E` node. It is automatically joined to its predecessor on the branch by the implicit `join` option.

When the first branch ends, only the plus node has been added and the current chain is the original chain once more and we are back to the `E` node. Now we start a new branch for the minus node. After this branch, the current chain ends at `E` node once more.

Finally, the rightmost unsigned integer is added to the (main) chain, which is why it is joined correctly with the `E` node. The two additional `join` options get a special `with` parameter. This allows you to join a node with a node other than the predecessor on the chain. The `with` should be followed by the name of a node.

Since Ilka will need scopes more often in the following, she includes the `scopes` library. This allows her to replace `\begin{scope}` simply by an opening brace and `\end{scope}` by the corresponding closing brace. Also, in the following example we reference the nodes `plus` and `minus` using their automatic name: The  $i$ th node on a chain is called `chain-⟨i⟩`. For a branch  $\langle branch \rangle$ , the  $i$ th node is called `chain/⟨branch⟩-⟨i⟩`. The  $\langle i \rangle$  can be replaced by `begin` and `end` to reference the first and (currently) last node on the chain.

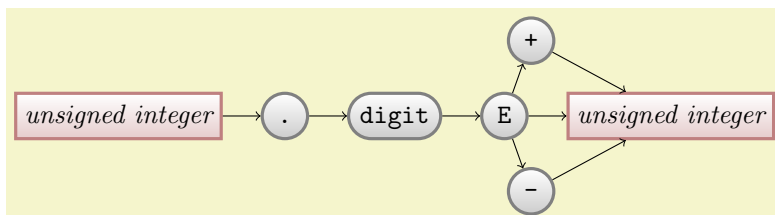

```

\begin{tikzpicture}[start chain,node distance=5mm, every on chain/.style={join}, every join/.style={->}]
  \node [on chain,nonterminal] {unsigned integer};
  \node [on chain,terminal]     {.};
  \node [on chain,terminal]     {digit};
  \node [on chain,terminal]     {E};
  { [start branch=plus]
    \node (plus) [terminal,on chain=going above right] {+};
  }
  { [start branch=minus]
    \node (minus) [terminal,on chain=going below right] {-};
  }
  \node [nonterminal,on chain,join=with chain/plus-end,join=with chain/minus-end] {unsigned integer};
\end{tikzpicture}

```

The next step is to add intermediate coordinate nodes in the same manner as Ilka did for the matrix. For them, we change the `join` style slightly, namely for these nodes we do not want an arrow tip. This can be achieved either by (locally) changing the `every join` style or, which is what is done in the below example, by giving the desired style using `join=by ...`, where `...` is the style to be used for the join.

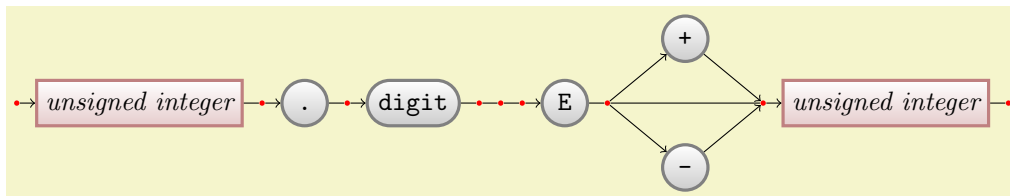

```

\begin{tikzpicture}[start chain,node distance=5mm and 2mm,
  every node/.style={on chain},
  nonterminal/.append style={join=by ->},
  terminal/.append style={join=by ->},
  point/.style={join=by -,circle,fill=red,minimum size=2pt,inner sep=0pt}]
  \node [point] {}; \node [nonterminal] {unsigned integer};
  \node [point] {}; \node [terminal]     {.};
  \node [point] {}; \node [terminal]     {digit};
  \node [point] {}; \node [point]       {};
  \node [point] {}; \node [terminal]     {E};
  \node [point] {};
  { [node distance=5mm and 1cm] % local change in horizontal distance
    { [start branch=plus]
      \node (plus) [terminal,on chain=going above right] {+};
    }
    { [start branch=minus]
      \node (minus) [terminal,on chain=going below right] {-};
    }
    \node [point,below right=of plus,join=with chain/plus-end by ->,join=with chain/minus-end by ->] {};
  }
  \node [nonterminal] {unsigned integer};
  \node [point]       {};
\end{tikzpicture}

```

### 5.4.3 Chaining Together Already Positioned Nodes

The final step is to add the missing arrows. We can also use branches for them (even though we do not have to, but it is good practice and they exhibit the structure of the diagram in the code).

Let us start with the repeat loop around the `digit`. This can be thought of as a branch that starts at the point after the `digit` and that ends at the point before the `digit`. However, we have already constructed the point before the `digit`! In such cases, it is possible to “chain in” an already positioned node, using the `\chainin` command. This command must be followed by a coordinate that contains a node name and optionally some options. The effect is that the named node is made part of the current chain.



```

\begin{tikzpicture}[start chain] % plus some styles that are not shown
  \node [point] {};
  \node (before digit) [point] {};
  \node [terminal]     {digit};
  \node [point] {};
  { [start branch=digit loop]
    \chainin (before digit) [join=by {->,skip loop=-5mm}];
  }
  \node [point] {};
\end{tikzpicture}

```

#### 5.4.4 Combined Use of Matrices and Chains

Ilka's final idea is to combine matrices and chains in the following manner: She will use a matrix to position the nodes. However, to show the logical "flow structure" inside the diagram, she will create chains and branches that show what is going on.

Ilka starts with the matrix we had earlier, only with slightly adapted styles. Then she writes down the main chain and its branches:

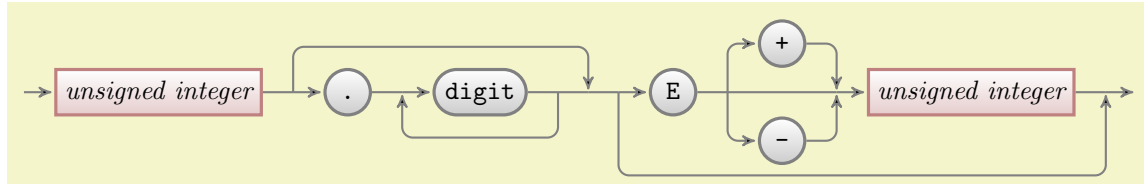

```

\begin{tikzpicture}[point/.style={coordinate},>=stealth',thick,draw=black!50,
tip/.style={->,shorten >=1pt},every join/.style={rounded corners},
hv path/.style={to path={-| (\tikztotarget)}},
vh path/.style={to path={|- (\tikztotarget)}}]
\matrix[column sep=4mm] {
% First row:
& & & & & & & & & \node (plus) [terminal] {+};\\
% Second row:
\node (p1) [point] {}; & & \node (ui1) [nonterminal] {unsigned integer}; & & \\
\node (p2) [point] {}; & & \node (dot) [terminal] {.}; & & \\
\node (p3) [point] {}; & & \node (digit) [terminal] {digit}; & & \\
\node (p4) [point] {}; & & \node (p5) [point] {}; & & \\
\node (p6) [point] {}; & & \node (e) [terminal] {E}; & & \\
\node (p7) [point] {}; & & & & \\
\node (p8) [point] {}; & & \node (ui2) [nonterminal] {unsigned integer}; & & \\
\node (p9) [point] {}; & & \node (p10) [point] {}; & & \\
% Third row:
& & & & & & & & & \node (minus)[terminal] {-};\\
};

{ [start chain]
\chainin (p1);
\chainin (ui1) [join=by tip];
\chainin (p2) [join];
\chainin (dot) [join=by tip];
\chainin (p3) [join];
\chainin (digit) [join=by tip];
\chainin (p4) [join];
{ [start branch=digit loop]
\chainin (p3) [join=by {skip loop=-6mm,tip}];
}
\chainin (p5) [join,join=with p2 by {skip loop=6mm,tip}];
\chainin (p6) [join];
\chainin (e) [join=by tip];
\chainin (p7) [join];
{ [start branch=plus]
\chainin (plus) [join=by {vh path,tip}];
\chainin (p8) [join=by {hv path,tip}];
}
{ [start branch=minus]
\chainin (minus) [join=by {vh path,tip}];
\chainin (p8) [join=by {hv path,tip}];
}
\chainin (p8) [join];
\chainin (ui2) [join=by tip];
\chainin (p9) [join,join=with p6 by {skip loop=-11mm,tip}];
\chainin (p10) [join=by tip];
}
\end{tikzpicture}

```

## 6 Tutorial: A Lecture Map for Johannes

In this tutorial we explore the tree and mind map mechanisms of `TikZ`.

Johannes is quite excited: For the first time he will be teaching a course all by himself during the upcoming semester! Unfortunately, the course is not on his favorite subject, which is of course Theoretical Immunology, but on Complexity Theory, but as a young academic Johannes is not likely to complain too loudly. In order to help the students get a general overview of what is going to happen during the course as a whole, he intends to draw some kind of tree or graph containing the basic concepts. He got this idea from his old professor who seems to be using these “lecture maps” with some success. Independently of the success of these maps, Johannes thinks they look quite neat.

### 6.1 Problem Statement

Johannes wishes to create a lecture map with the following features:

1. It should contain a tree or graph depicting the main concepts.
2. It should somehow visualize the different lectures that will be taught. Note that the lectures are not necessarily the same as the concepts since the graph may contain more concepts than will be addressed in lectures and some concepts may be addressed during more than one lecture.
3. The map should also contain a calendar showing when the individual lectures will be given.
4. The aesthetical reasons, the whole map should have a visually nice and information-rich background.

As always, Johannes will have to include the right libraries and setup the environment. Since Johannes is going to use the `mindmap` library and since he wishes to show a calendar, he will need the `mindmap` and the `calendar` libraries. In order to put something on a background layer, it seems like a good idea to also include the `background` library.

### 6.2 Introduction to Trees

The first choice Johannes must make is whether he will organize the concepts as a tree, with root concepts and concept branches and leaf concepts, or as a general graph. The tree implicitly organizes the concepts, while a graph is more flexible. Johannes decides to compromise: Basically, the concepts will be organized as a tree. However, he will selectively add connections between concepts that are related, but which appear on different levels or branches of the tree.

Johannes starts with a tree-like list of concepts that he feels are important in Computational Complexity:

- Computational Problems
  - Problem Measures
  - Problem Aspects
  - Problem Domains
  - Key Problems
- Computational Models
  - Turing Machines
  - Random-Access Machines
  - Circuits
  - Binary Decision Diagrams
  - Oracle Machines
  - Programming in Logic
- Measuring Complexity
  - Complexity Measures
  - Classifying Complexity
  - Comparing Complexity
  - Describing Complexity
- Solving Problems

- Exact Algorithms
- Randomization
- Fixed-Parameter Algorithms
- Parallel Computation
- Partial Solutions
- Approximation

Johannes will surely need to modify this list later on, but it looks good as a first approximation. He will also need to add a number of subtopics (like *lots* of complexity classes under the topic “classifying complexity”), but he will do this as he constructs the map.

Turning the list of topics into a TikZ-tree is easy, in principle. The basic idea is that a node can have *children*, which in turn can have children of their own, and so on. To add a child to a node, Johannes can simply write `child {<node>}` right after a node. The `<node>` should, in turn, be the code for creating a node. To add another node, Johannes can use `child` once more, and so on. Johannes is eager to try out this construct and writes down the following:

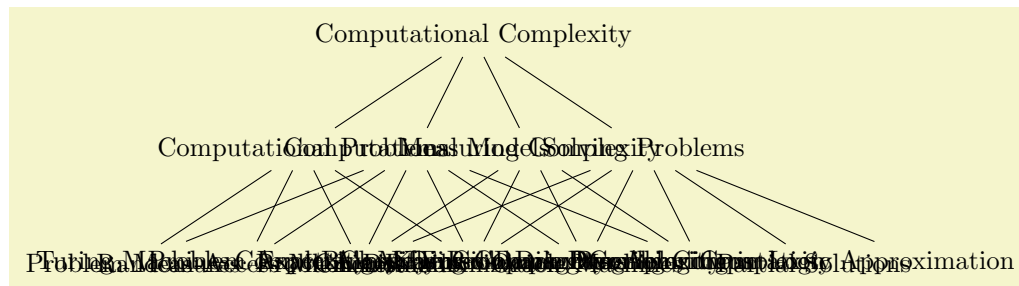

```
\tikz
\node {Computational Complexity} % root
  child { node {Computational Problems}
    child { node {Problem Measures} }
    child { node {Problem Aspects} }
    child { node {Problem Domains} }
    child { node {Key Problems} }
  }
  child { node {Computational Models}
    child { node {Turing Machines} }
    child { node {Random-Access Machines} }
    child { node {Circuits} }
    child { node {Binary Decision Diagrams} }
    child { node {Oracle Machines} }
    child { node {Programming in Logic} }
  }
  child { node {Measuring Complexity}
    child { node {Complexity Measures} }
    child { node {Classifying Complexity} }
    child { node {Comparing Complexity} }
    child { node {Describing Complexity} }
  }
  child { node {Solving Problems}
    child { node {Exact Algorithms} }
    child { node {Randomization} }
    child { node {Fixed-Parameter Algorithms} }
    child { node {Parallel Computation} }
    child { node {Partial Solutions} }
    child { node {Approximation} }
  }
};
```

Well, that did not quite work out as expected (although, what, exactly, did one expect?). There are two problems:

1. The overlap of the nodes is due to the fact that TikZ is not particularly smart when it comes to placing child nodes. Even though it is possible to configure TikZ to use rather clever placement methods, TikZ has no way of taking the actual size of the child nodes into account. This may seem strange but the reason is that the child nodes are rendered and placed one at a time, so the size of the last node is not known when the first node is being processed. In essence, you have to specify appropriate level and sibling node spacings “by hand.”

- The standard computer-science-top-down rendering of a tree is rather ill-suited to visualizing the concepts. It would be better to either rotate the map by ninety degrees or, even better, to use some sort of circular arrangement.

Johannes redraws the tree, but this time with some more appropriate options set, which he found more or less by trial-and-error:

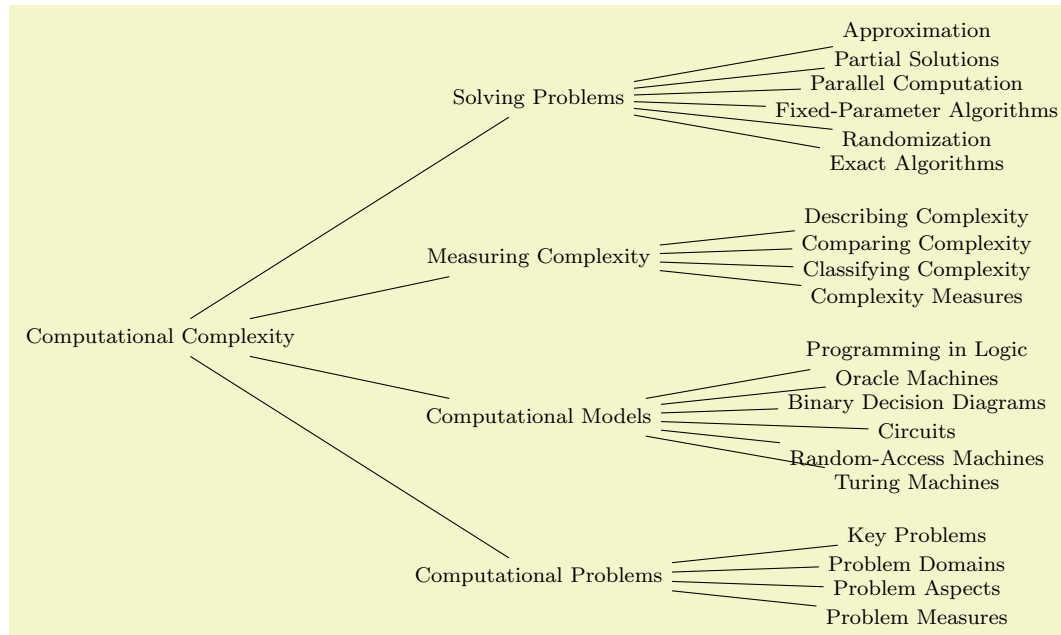

```

\tikz [font=\footnotesize,
      grow=right, level 1/.style={sibling distance=6em},
      level 2/.style={sibling distance=1em}, level distance=5cm]
\node {Computational Complexity} % root
  child { node {Computational Problems}
    child { node {Problem Measures} }
    child { node {Problem Aspects} }
    ... % as before
  }

```

Still not quite what Johannes had in mind, but he is getting somewhere.

For configuring the tree, two parameters are of particular importance: The `level distance` tells `TikZ` the distance between (the centers of) the nodes on adjacent levels or layers of a tree. The `sibling distance` is, as the name suggests, the distance between (the centers of) siblings of the tree.

You can globally set these parameters for a tree by simply setting them somewhere before the tree starts, but you will typically wish them to be different for different levels of the tree. In this case, you should set styles like `level 1` or `level 2`. For the first level of the tree, the `level 1` style is used, for the second level the `level 2` style, and so on. You can also set the sibling and level distances only for certain nodes by passing these options to the `child` command as options. (Note that the options of a `node` command are local to the node and have no effect on the children. Also note that it is possible to specify options that do have an effect on the children. Finally note that specifying options for children “at the right place” is an arcane art and you should peruse Section 18.4 on a rainy Sunday afternoon, if you are really interested.)

The `grow` key is used to configure the direction in which a tree grows. You can change growth direction “in the middle of a tree” simply by changing this key for a single child or a whole level. By including the `tree` library you also get access to additional growth strategies such as a “circular” growth:

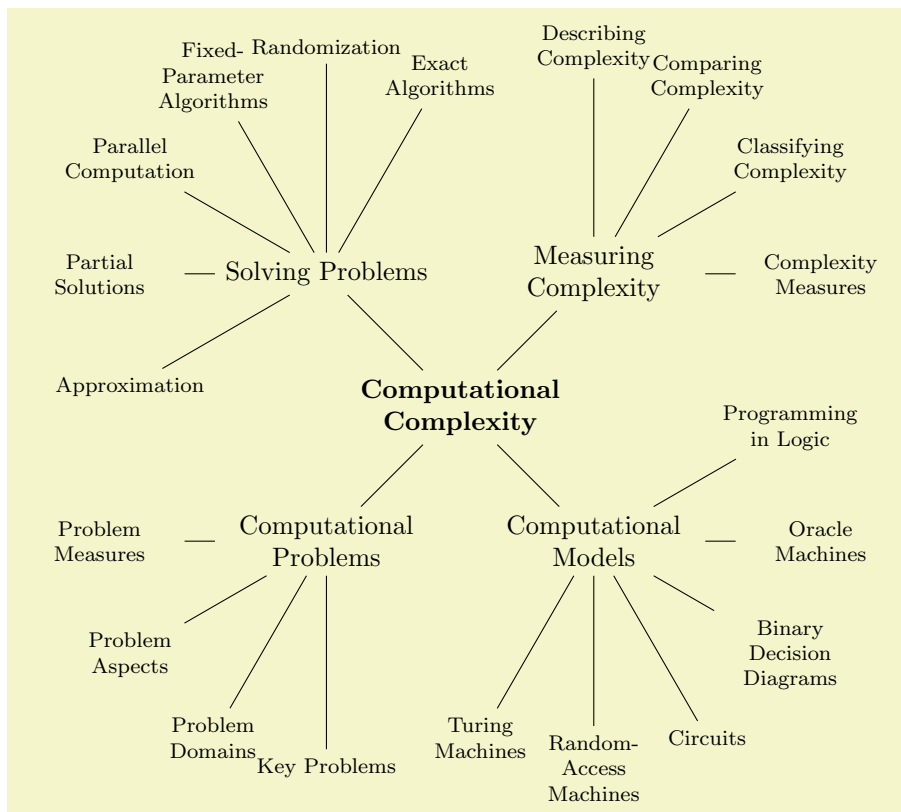

```

\tikz [text width=2.7cm, align=flush center,
grow cyclic,
level 1/.style={level distance=2.5cm,sibling angle=90},
level 2/.style={text width=2cm, font=\footnotesize, level distance=3cm,sibling angle=30}]
\node[font=\bfseries] {Computational Complexity} % root
child { node {Computational Problems}
child { node {Problem Measures} }
child { node {Problem Aspects} }
... % as before

```

Johannes is pleased to learn that he can access and manipulate the nodes of tree like any normal node. In particular, he can name them using the `name=` option or the `(\langle name \rangle)` notation and he can use any available shape or style for the trees nodes. He can connect trees later on using the normal `\draw (some node) -- (another node);` syntax. In essence, the `child` command just computes an appropriate position for a node and adds a line from the child to the parent node.

### 6.3 Creating the Lecture Map

Johannes now has a first possible layout for his lecture map. The next step is to make it “look nicer.” For this, the `mindmap` library is helpful since it makes a number of styles available that will make a tree look like a nice “mind map” or “concept map.”

The first step is to include the `mindmap` library, which Johannes already did. Next, he must add one of the following options to a scope that will contain the lecture map: `mindmap` or `large mindmap` or `huge mindmap`. These options all have the same effect, except that for a `large mindmap` the predefined font size and node sizes are somewhat larger than for a standard `mindmap` and for a `huge mindmap` they are even larger. So, a `large mindmap` does not necessarily need to have a lot of concepts, but it will need a lot of paper.

The second step is to add the `concept` option to every node that will, indeed, be a concept of the mindmap. The idea is that some nodes of a tree will be real concepts, while other nodes might just be “simple children.” Typically, this is not the case, so you might consider saying `every node/.style=concept`.

The third step is to setup the sibling `angle` (rather than a sibling distance) to specify the angle between sibling concepts.

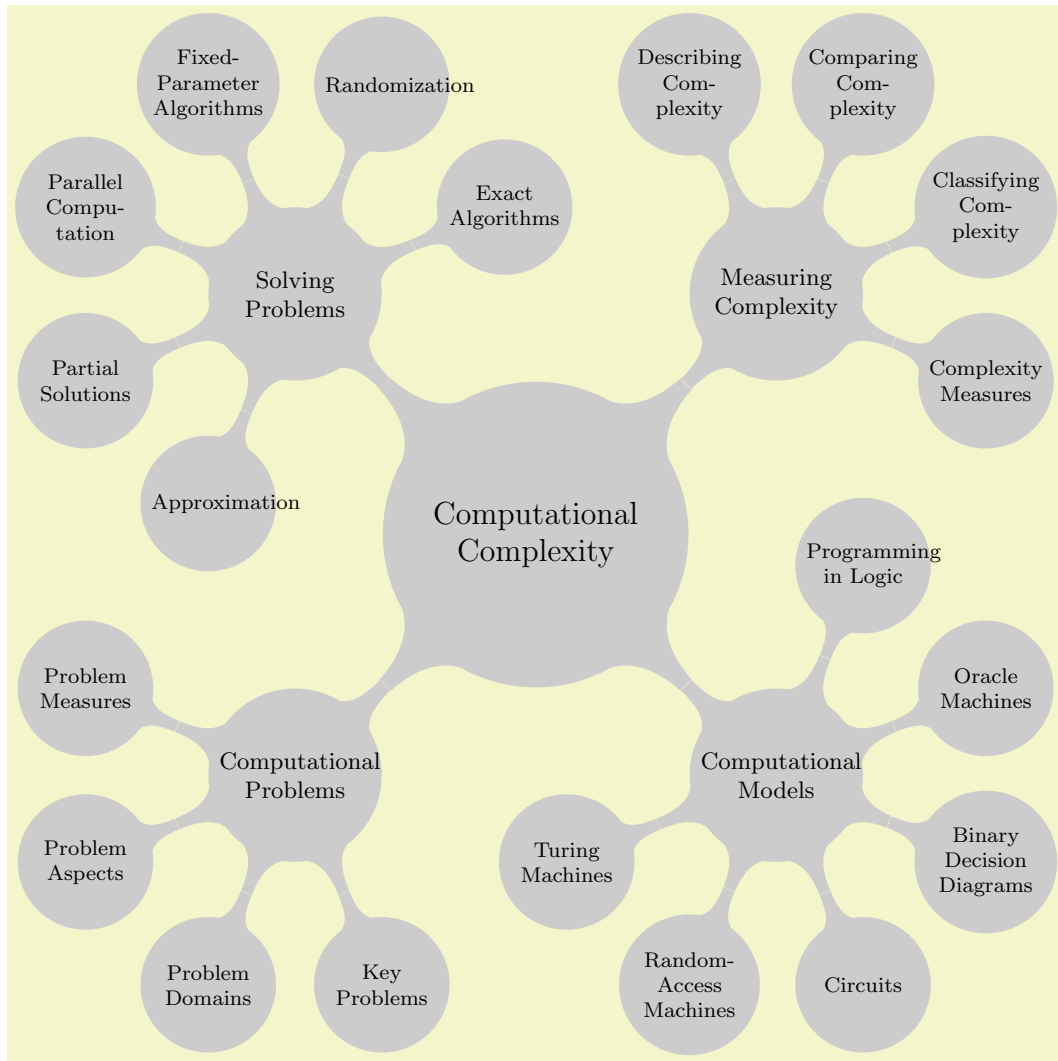

```

\tikz [mindmap, every node/.style=concept, concept color=black!20,
grow cyclic,
level 1/.append style={level distance=4.5cm,sibling angle=90},
level 2/.append style={level distance=3cm,sibling angle=45}]
\node [root concept] {Computational Complexity} % root
  child { node {Computational Problems}
    child { node {Problem Measures} }
    child { node {Problem Aspects} }
    ... % as before
  }

```

When Johannes typesets the above map,  $\text{\TeX}$  (rightfully) starts complaining about several overfull boxes and, indeed, words like “Randomization” stretch out beyond the circle of the concept. This seems a bit mysterious at first sight: Why does  $\text{\TeX}$  not hyphenate the word? The reason is that  $\text{\TeX}$  will never hyphenate the first word of a paragraph because it starts looking for “hyphenatable” letters only after a so-called glue. In order to have  $\text{\TeX}$  hyphenate these single words, Johannes must use a bit of evil trickery: He inserts a  $\text{\hspace{0pt}}$  before the word. This has no effect except for inserting an (invisible) glue before the word and, thereby, allowing  $\text{\TeX}$  to hyphenate the first word also. Since Johannes does not want to add  $\text{\hspace{0pt}}$  inside each node, he uses the `execute at begin node` option to make  $\text{\tikz}$  insert this text with every node.



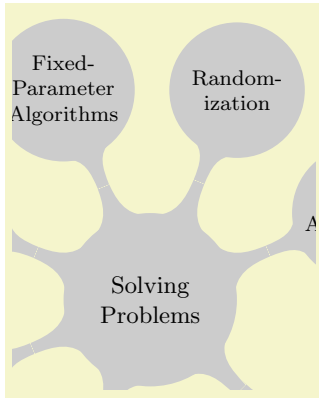

```

\begin{tikzpicture}
[mindmap,
every node/.style={concept, execute at begin node=\hskip0pt},
concept color=black!20,
grow cyclic,
level 1/.append style={level distance=4.5cm,sibling angle=90},
level 2/.append style={level distance=3cm,sibling angle=45}]
\clip (-1,2) rectangle ++ (-4,5);
\node [root concept] {Computational Complexity} % root
  child { node {Computational Problems}
    child { node {Problem Measures} }
    child { node {Problem Aspects} }
    ... % as before
  }
\end{tikzpicture}

```

In the above example a clipping was used to show only part of the lecture map, in order to save space. The same will be done in the following examples, we return to the complete lecture map at the end of this tutorial.

Johannes is now eager to colorize the map. The idea is to use different colors for different parts of the map. He can then, during his lectures, talk about the “green” or the “red” topics. This will make it easier for his students to locate the topic he is talking about on the map. Since “computational problems” somehow sounds “problematic,” Johannes chooses red for them, while he picks green for the “solving problems.” The topics “measuring complexity” and “computational models” get more neutral colors; Johannes picks orange and blue.

To set the colors, Johannes must use the `concept color` option, rather than just, say, `node [fill=red]`. Setting just the fill color to `red` would, indeed, make the node red, but it would *just* make the node red and not the bar connecting the concept to its parent and also not its children. By comparison, the special `concept color` option will not only set the color of the node and its children, but it will also (magically) create appropriate shadings so that the color of a parent concept smoothly changes to the color of a child concept.

For the root concept Johannes decides to do something special: He sets the concept color to black, sets the line width to a large value, and sets the fill color to white. The effect of this is that the root concept will be encircled with a thick black line and the children are connected to the central concept via bars.

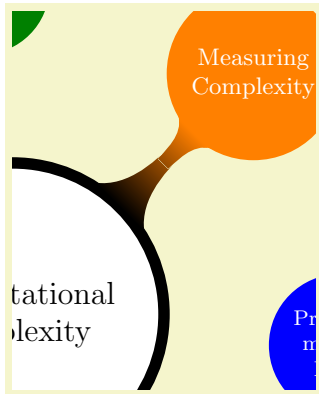

```

\begin{tikzpicture}
[mindmap,
every node/.style={concept, execute at begin node=\hskip0pt},
root concept/.append style={
concept color=black, fill=white, line width=1ex, text=black},
text=white,
grow cyclic,
level 1/.append style={level distance=4.5cm,sibling angle=90},
level 2/.append style={level distance=3cm,sibling angle=45}]
\clip (0,-1) rectangle ++(4,5);
\node [root concept] {Computational Complexity} % root
  child [concept color=red] { node {Computational Problems}
    child { node {Problem Measures} }
    ... % as before
  }
  child [concept color=blue] { node {Computational Models}
    child { node {Turing Machines} }
    ... % as before
  }
  child [concept color=orange] { node {Measuring Complexity}
    child { node {Complexity Measures} }
    ... % as before
  }
  child [concept color=green!50!black] { node {Solving Problems}
    child { node {Exact Algorithms} }
    ... % as before
  };
\end{tikzpicture}

```

Johannes adds three finishing touches: First, he changes the font of the main concepts to small caps. Second, he decides that some concepts should be “faded,” namely those that are important in principle and belong on the map, but which he will not talk about in his lecture. To achieve this, Johannes defines four styles, one for each of the four main branches. These styles (a) setup the correct concept color for the whole branch

and (b) define the faded style appropriately for this branch. Third, he adds a circular drop shadow, defined in the shadows library, to the concepts, just to make things look a bit more fancy.

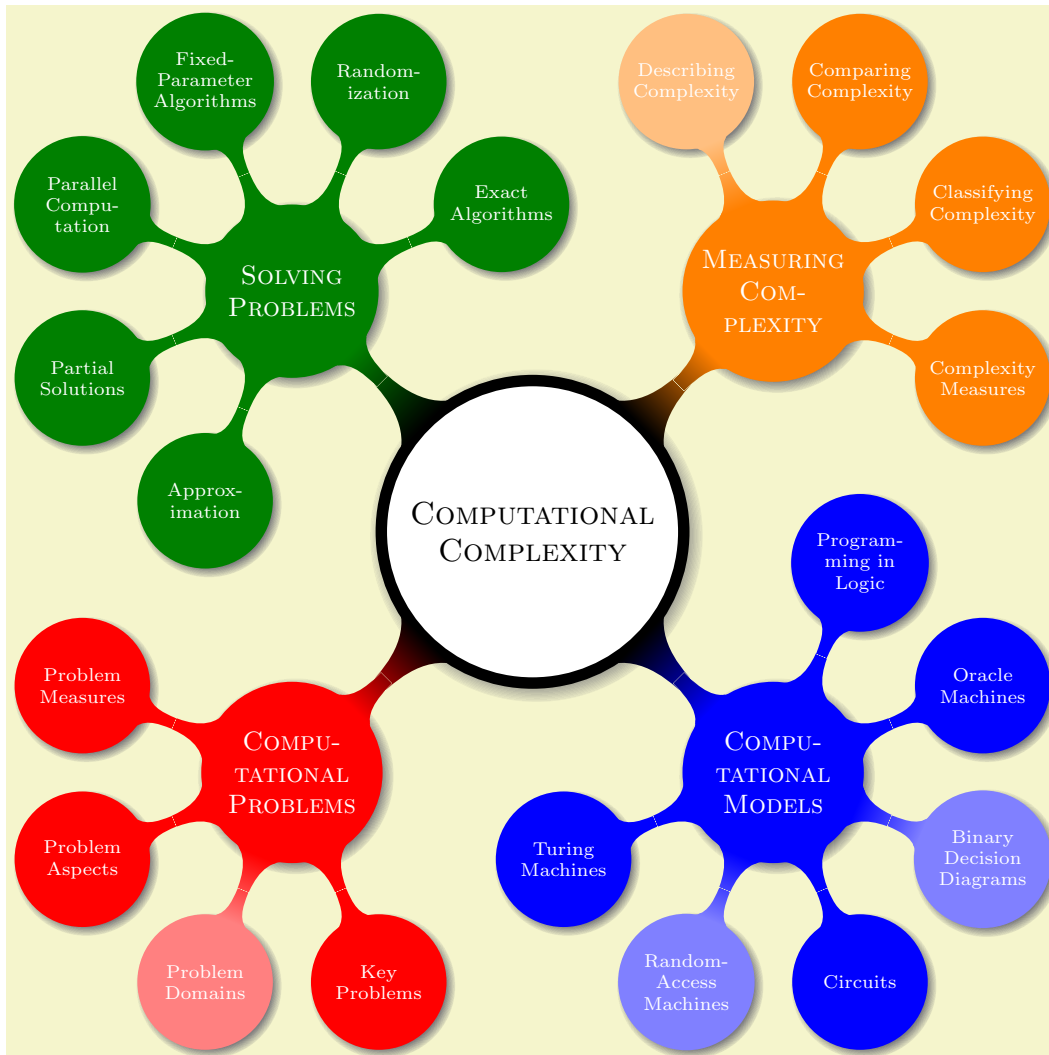

```

\begin{tikzpicture}[mindmap]
  \begin{scope}[
    every node/.style={concept, circular drop shadow,execute at begin node=\hskip0pt},
    root concept/.append style={
      concept color=black, fill=white, line width=1ex, text=black, font=\large\scshape,
      text=white,
      computational problems/.style={concept color=red,faded/.style={concept color=red!50}},
      computational models/.style={concept color=blue,faded/.style={concept color=blue!50}},
      measuring complexity/.style={concept color=orange,faded/.style={concept color=orange!50}},
      solving problems/.style={concept color=green!50!black,faded/.style={concept color=green!50!black!50}},
      grow cyclic,
      level 1/.append style={level distance=4.5cm,sibling angle=90,font=\scshape},
      level 2/.append style={level distance=3cm,sibling angle=45,font=\scriptsize}
    ]
    \node [root concept] {Computational Complexity} % root
      child [computational problems] { node {Computational Problems}
        child { node {Problem Measures} }
        child { node {Problem Aspects} }
        child [faded] { node {Problem Domains} }
        child { node {Key Problems} }
      }
      child [computational models] { node {Computational Models}
        child { node {Turing Machines} }
        child [faded] { node {Random-Access Machines} }
        ...
      }
    \end{scope}
\end{tikzpicture}

```

## 6.4 Adding the Lecture Annotations

Johannes will give about a dozen lectures during the course “computational complexity.” For each lecture he has compiled a (short) list of learning targets that state what knowledge and qualifications his students should acquire during this particular lecture (note that learning targets are not the same as the contents of a lecture). For each lecture he intends to put a little rectangle on the map containing these learning targets and the name of the lecture, each time somewhere near to the topic of the lecture. Such “little rectangles” are called “annotations” by the mindmap library.

In order to place the annotations next to the concepts, Johannes must assign names to the nodes of the concepts. He could rely on TikZ’s automatic naming of the nodes in a tree, where the children of a node named `root` are named `root-1`, `root-2`, `root-3`, and so on. However, since Johannes is not sure about the final order of the concepts in the tree, it seems better to explicitly name all concepts of the tree in the following manner:

```
\node [root concept] (Computational Complexity) {Computational Complexity}
  child [computational problems] { node (Computational Problems) {Computational Problems}
    child { node (Problem Measures) {Problem Measures} }
    child { node (Problem Aspects) {Problem Aspects} }
    child [faded] { node (Problem Domains) {Problem Domains} }
    child { node (Key Problems) {Key Problems} }
  }
...
```

The annotation style of the mind map library mainly sets up a rectangular shape of appropriate size. Johannes configures the style by defining every annotation appropriately.

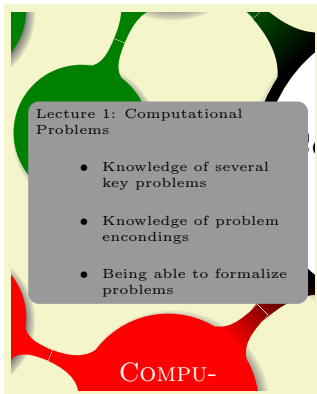

```
\begin{tikzpicture}[mindmap]
\clip (-5,-5) rectangle ++ (4,5);
\begin{scope}[
every node/.style={concept, circular drop shadow, ... % as before
\node [root concept] (Computational Complexity) ... % as before
\end{scope}

\begin{scope}[every annotation/.style={fill=black!40}]
\node [annotation, above] at (Computational Problems.north) {
\begin{itemize}
\item Knowledge of several key problems
\item Knowledge of problem encodings
\item Being able to formalize problems
\end{itemize}
};
\end{scope}
\end{tikzpicture}
```

Well, that does not yet look quite perfect. The spacing or the `{itemize}` is not really appropriate and the node is too large. Johannes can configure these things “by hand,” but it seems like a good idea to define a macro that will take care of these things for him. The “right” way to do this is to define a `\lecture` macro that takes a list of key-value pairs as argument and produces the desired annotation. However, to keep things simple, Johannes’ `\lecture` macro simply takes a fixed number of arguments having the following meaning: The first argument is the number of the lecture, the second is the name of the lecture, the third are positioning options like `above`, the fourth is the position where the node is placed, the fifth is the list of items to be shown, and the sixth is a date when the lecture will be held (this parameter is not yet needed, we will, however, need it later on).

```
\def\lecture#1#2#3#4#5#6{
\node [annotation, #3, scale=0.65, text width=4cm, inner sep=2mm] at (#4) {
Lecture #1: \textcolor{orange}{\textbf{#2}}
\list{--}{\topsep=2pt\itemsep=0pt\parsep=0pt
\parskip=0pt\labelwidth=8pt\leftmargin=8pt
\itemindent=0pt\labelsep=2pt}
#5
\endlist
};
}
```

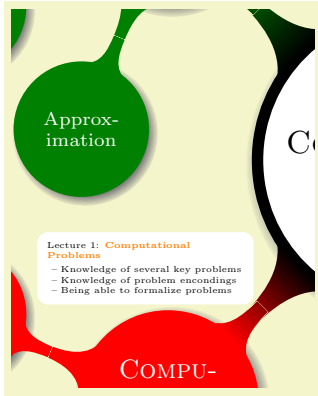

```

\begin{tikzpicture}[mindmap, every annotation/.style={fill=white}]
\clip (-5,-5) rectangle ++ (4,5);
\begin{scope}[
every node/.style={concept, circular drop shadow, ... % as before
\node [root concept] (Computational Complexity) ... % as before
\end{scope}

\lecture{1}{Computational Problems}{above,xshift=-3mm}
{Computational Problems.north}{
\item Knowledge of several key problems
\item Knowledge of problem encodings
\item Being able to formalize problems
}{2009-04-08}
\end{tikzpicture}

```

In the same fashion Johannes can now add the other lecture annotations. Obviously, Johannes will have some trouble fitting everything on a single A4-sized page, but by adjusting the spacing and some experimentation he can quickly arrange all the annotations as needed.

## 6.5 Adding the Background

Johannes has already used colors to organize his lecture map into four regions, each having a different color. In order to emphasize these regions even more strongly, he wishes to add a background coloring to each of these regions.

Adding these background colors turns out to be more tricky than Johannes would have thought. At first sight, what he needs is some sort of “color wheel” that is blue in the lower right direction and then changes smoothly to orange in the upper right direction and then to green in the upper left direction and so on. Unfortunately, there is no easy way of creating a true such a color wheel shading (although it can be done, in principle, but only at a very high cost, see page 400 for an example).

Johannes decides to do something a bit more basic: He creates four large rectangles, one for each of the four quadrants around the central concept, each colored with a light version of the quadrant. Then, in order to “smooth” the change between adjacent rectangles, he puts four shadings on top of them.

Since these background rectangles should go “behind” everything else, Johannes puts all his background stuff on the `background` layer.

In the following code, only the central concept is shown to save some space:



```

\begin{tikzpicture}[
  mindmap,
  concept color=black,
  root concept/.append style={
    concept,
    circular drop shadow,
    fill=white, line width=1ex,
    text=black, font=\large\scshape}
]

\clip (-1.5,-5) rectangle ++(4,10);

\node [root concept] (Computational Complexity) {Computational Complexity};

\begin{pgfonlayer}{background}
\clip (-1.5,-5) rectangle ++(4,10);

\colorlet{upperleft}{green!50!black!25}
\colorlet{upperright}{orange!25}
\colorlet{lowerleft}{red!25}
\colorlet{lowerright}{blue!25}

% The large rectangles:
\fill [upperleft] (Computational Complexity) rectangle ++(-20,20);
\fill [upperright] (Computational Complexity) rectangle ++(20,20);
\fill [lowerleft] (Computational Complexity) rectangle ++(-20,-20);
\fill [lowerright] (Computational Complexity) rectangle ++(20,-20);

% The shadings:
\shade [left color=upperleft,right color=upperright]
  ([xshift=-1cm]Computational Complexity) rectangle ++(2,20);
\shade [left color=lowerleft,right color=lowerright]
  ([xshift=-1cm]Computational Complexity) rectangle ++(2,-20);
\shade [top color=upperleft,bottom color=lowerleft]
  ([yshift=-1cm]Computational Complexity) rectangle ++(-20,2);
\shade [top color=upperright,bottom color=lowerright]
  ([yshift=-1cm]Computational Complexity) rectangle ++(20,2);
\end{pgfonlayer}
\end{tikzpicture}

```

## 6.6 Adding the Calendar

Johannes intends to plan his lecture rather carefully. In particular, he already knows when each of his lectures will be held during the course. Naturally, this does not mean that Johannes will slavishly follow the plan and he might need longer for some subjects than he anticipated, but nevertheless he has a detailed plan of when which subject will be addressed.

Johannes intends to share this plan with his students by adding a calendar to the lecture map. In addition to serving as a reference on which particular day a certain topic will be addressed, the calendar is also useful so show the overall chronological order of the course.

In order to add a calendar to a *TikZ* graphic, the `calendar` library is most useful. The library provides the `\calendar` command, which takes a large number of options and which can be configured in many ways to produce just about any kind of calendar imaginable. For Johannes' purposes, a simple `day list downward` will be a nice option since it produces a list of days that go "downward".

```

1 \tiny
2 \begin{tikzpicture}
3   \calendar [day list downward,
4             name=cal,
5             dates=2009-04-01 to 2009-04-14]
6             if (weekend)
7               [black!25];
8 \end{tikzpicture}
9
10
11
12
13
14

```

Using the `name` option, we gave a name to the calendar, which will allow us to reference the nodes that make up the individual days of the calendar later on. For instance, the rectangular node containing the 1 that represents April 1st, 2009, can be referenced as `(cal-2009-04-01)`. The `dates` option is used to specify

an interval for which the calendar should be drawn. Johannes will need several months in his calendar, but the above example only shows two weeks to save some space.

Note the `if (weekend)` construct. The `\calendar` command is followed by options and then by `if`-statements. These `if`-statements are checked for each day of the calendar and when a date passes this test, the options or the code following the `if`-statement is executed. In the above example, we make weekend days (Saturdays and Sundays, to be precise) lighter than normal days. (Use your favorite calendar to check that, indeed, April 5th, 2009, is a Sunday.)

As mentioned above, Johannes can reference the nodes that are used to typeset days. Recall that his `\lecture` macro already got passed a date, which we did not use, yet. We can now use it to place the lecture's title next to the date when the lecture will be held:

```
\def\lecture#1#2#3#4#5#6{
  % As before:
  \node [annotation, #3, scale=0.65, text width=4cm, inner sep=2mm] at (#4) {
    Lecture #1: \textcolor{orange}{\textbf{#2}}
    \list{--}{\topsep=2pt\itemsep=0pt\parsep=0pt
      \parskip=0pt\labelwidth=8pt\leftmargin=8pt
      \itemindent=0pt\labelsep=2pt}
    #5
  \endlist
  };
  % New:
  \node [anchor=base west] at (cal-#6.base east) {\textcolor{orange}{\textbf{#2}}};
}
```

Johannes can now use this new `\lecture` command as follows (in the example, only the new part of the definition is used):

|                                                                    |                                                                                                                                                                                                                                                                                                                                                                                                                                        |
|--------------------------------------------------------------------|----------------------------------------------------------------------------------------------------------------------------------------------------------------------------------------------------------------------------------------------------------------------------------------------------------------------------------------------------------------------------------------------------------------------------------------|
| <pre>1 2 3 4 5 6 7 8 Computational Problems 9 10 11 12 13 14</pre> | <pre>\tiny \begin{tikzpicture}   \calendar [day list downward,     name=cal,     dates=2009-04-01 to 2009-04-14]     if (weekend)       [black!25];    % As before:   \lecture{1}{Computational Problems}{above,xshift=-3mm}   {Computational Problems.north}{     \item Knowledge of several key problems     \item Knowledge of problem encodings     \item Being able to formalize problems   }{2009-04-08} \end{tikzpicture}</pre> |
|--------------------------------------------------------------------|----------------------------------------------------------------------------------------------------------------------------------------------------------------------------------------------------------------------------------------------------------------------------------------------------------------------------------------------------------------------------------------------------------------------------------------|

As a final step, Johannes needs to add a few more options to the calendar command: He uses the `month text` option to configure how the text of a month is rendered (see Section 26 for details) and then typesets the month text at a special position at the beginning of each month.

|            |                        |
|------------|------------------------|
| April 2009 |                        |
| 1          |                        |
| 2          |                        |
| 3          |                        |
| 4          |                        |
| 5          |                        |
| 6          |                        |
| 7          |                        |
| 8          | Computational Problems |
| 9          |                        |
| 10         |                        |
| 11         |                        |
| 12         |                        |
| 13         |                        |
| 14         |                        |
| 15         | Computational Models   |
| 16         |                        |
| 17         |                        |
| 18         |                        |
| 19         |                        |
| 20         |                        |
| 21         |                        |
| 22         |                        |
| 23         |                        |
| 24         |                        |
| 25         |                        |
| 26         |                        |
| 27         |                        |
| 28         |                        |
| 29         |                        |
| 30         |                        |
| May 2009   |                        |
| 1          |                        |

```

\tiny
\begin{tikzpicture}
  \calendar [day list downward,
            month text=\%mt\ \%y0,
            month yshift=3.5em,
            name=cal,
            dates=2009-04-01 to 2009-05-01]
    if (weekend)
      [black!25]
    if (day of month=1) {
      \node at (0pt,1.5em) [anchor=base west] {\small\tikzmonthtext};
    };

  \lecture{1}{Computational Problems}{above,xshift=-3mm}
  {Computational Problems.north}{
    \item Knowledge of several key problems
    \item Knowledge of problem encodings
    \item Being able to formalize problems
  }{2009-04-08}

  \lecture{2}{Computational Models}{above,xshift=-3mm}
  {Computational Models.north}{
    \item Knowledge of Turing machines
    \item Being able to compare the computational power of different
      models
  }{2009-04-15}
\end{tikzpicture}

```

## 6.7 The Complete Code

Putting it all together, Johannes gets the following code:

First comes the definition of the `\lecture` command:

```

\def\lecture#1#2#3#4#5#6{
  % As before:
  \node [annotation, #3, scale=0.65, text width=4cm, inner sep=2mm, fill=white] at (#4) {
    Lecture #1: \textcolor{orange}{\textbf{#2}}
    \list{--}{\topsep=2pt\itemsep=0pt\parsep=0pt
             \parskip=0pt\labelwidth=8pt\leftmargin=8pt
             \itemindent=0pt\labelsep=2pt}
    #5
  \endlist
  };
  % New:
  \node [anchor=base west] at (cal-#6.base east) {\textcolor{orange}{\textbf{#2}}};
}

```

This is followed by the main mindmap setup...

```

\noindent
\begin{tikzpicture}
  \begin{scope}[
    mindmap,
    every node/.style={concept, circular drop shadow,execute at begin node=\hskip0pt},
    root concept/.append style={
      concept color=black,
      fill=white, line width=1ex,
      text=black, font=\large\scshape},
    text=white,
    computational problems/.style={concept color=red,faded/.style={concept color=red!50}},
    computational models/.style={concept color=blue,faded/.style={concept color=blue!50}},
    measuring complexity/.style={concept color=orange,faded/.style={concept color=orange!50}},
    solving problems/.style={concept color=green!50!black,faded/.style={concept color=green!50!black!50}},
    grow cyclic,
    level 1/.append style={level distance=4.5cm,sibling angle=90,font=\scshape},
    level 2/.append style={level distance=3cm,sibling angle=45,font=\scriptsize}]

```

... and contents:

```

\node [root concept] (Computational Complexity) {Computational Complexity} % root
  child [computational problems] { node [yshift=-1cm] (Computational Problems) {Computational Problems}
    child { node (Problem Measures) {Problem Measures} }
    child { node (Problem Aspects) {Problem Aspects} }
    child [faded] { node (problem Domains) {Problem Domains} }
    child { node (Key Problems) {Key Problems} }
  }
  child [computational models] { node [yshift=-1cm] (Computational Models) {Computational Models}
    child { node (Turing Machines) {Turing Machines} }
    child [faded] { node (Random-Access Machines) {Random-Access Machines} }
    child { node (Circuits) {Circuits} }
    child [faded] { node (Binary Decision Diagrams) {Binary Decision Diagrams} }
    child { node (Oracle Machines) {Oracle Machines} }
    child { node (Programming in Logic) {Programming in Logic} }
  }
  child [measuring complexity] { node [yshift=1cm] (Measuring Complexity) {Measuring Complexity}
    child { node (Complexity Measures) {Complexity Measures} }
    child { node (Classifying Complexity) {Classifying Complexity} }
    child { node (Comparing Complexity) {Comparing Complexity} }
    child [faded] { node (Describing Complexity) {Describing Complexity} }
  }
  child [solving problems] { node [yshift=1cm] (Solving Problems) {Solving Problems}
    child { node (Exact Algorithms) {Exact Algorithms} }
    child { node (Randomization) {Randomization} }
    child { node (Fixed-Parameter Algorithms) {Fixed-Parameter Algorithms} }
    child { node (Parallel Computation) {Parallel Computation} }
    child { node (Partial Solutions) {Partial Solutions} }
    child { node (Approximation) {Approximation} }
  }
};
\end{scope}

```

Now comes the calendar code:

```

\tiny
\calendar [day list downward,
  month text=\%mt\ \%y0,
  month yshift=3.5em,
  name=cal,
  at={(-.5\textwidth-5mm,.5\textheight-1cm)},
  dates=2009-04-01 to 2009-06-last]
if (weekend)
  [black!25]
if (day of month=1) {
  \node at (Opt,1.5em) [anchor=base west] {\small\tikzmonthtext};
};

```

The lecture annotations:

```

\lecture{1}{Computational Problems}{above,xshift=-5mm,yshift=5mm}{Computational Problems.north}{
  \item Knowledge of several key problems
  \item Knowledge of problem encodings
  \item Being able to formalize problems
}{2009-04-08}

\lecture{2}{Computational Models}{above left}
{Computational Models.west}{
  \item Knowledge of Turing machines
  \item Being able to compare the computational power of different
  models
}{2009-04-15}

```

Finally, the background:



```

\begin{pgfonlayer}{background}
  \clip[xshift=-1cm] (-.5\textwidth,-.5\textheight) rectangle ++(\textwidth,\textheight);

  \colorlet{upperleft}{green!50!black!25}
  \colorlet{upperright}{orange!25}
  \colorlet{lowerleft}{red!25}
  \colorlet{lowerright}{blue!25}

  % The large rectangles:
  \fill [upperleft] (Computational Complexity) rectangle ++(-20,20);
  \fill [upperright] (Computational Complexity) rectangle ++(20,20);
  \fill [lowerleft] (Computational Complexity) rectangle ++(-20,-20);
  \fill [lowerright] (Computational Complexity) rectangle ++(20,-20);

  % The shadings:
  \shade [left color=upperleft,right color=upperright]
    ([xshift=-1cm]Computational Complexity) rectangle ++(2,20);
  \shade [left color=lowerleft,right color=lowerright]
    ([xshift=-1cm]Computational Complexity) rectangle ++(2,-20);
  \shade [top color=upperleft,bottom color=lowerleft]
    ([yshift=-1cm]Computational Complexity) rectangle ++(-20,2);
  \shade [top color=upperright,bottom color=lowerright]
    ([yshift=-1cm]Computational Complexity) rectangle ++(20,2);
\end{pgfonlayer}
\end{tikzpicture}

```

The next page shows the resulting lecture map in all its glory (it would be somewhat more glorious, if there were more lecture annotations, but you should get the idea).

April 2009

- 1
- 2
- 3
- 4
- 5
- 6
- 7
- 8 **Computational Problems**
- 9
- 10
- 11
- 12
- 13
- 14
- 15 **Computational Models**
- 16
- 17
- 18
- 19
- 20
- 21
- 22
- 23
- 24
- 25
- 26
- 27
- 28
- 29
- 30

May 2009

- 1
- 2
- 3
- 4
- 5
- 6
- 7
- 8
- 9
- 10
- 11
- 12
- 13
- 14
- 15
- 16
- 17
- 18
- 19
- 20
- 21
- 22
- 23
- 24
- 25
- 26
- 27
- 28
- 29
- 30
- 31

June 2009

- 1
- 2
- 3
- 4
- 5
- 6
- 7
- 8
- 9
- 10
- 11
- 12
- 13
- 14
- 15
- 16
- 17
- 18
- 19
- 20
- 21
- 22
- 23
- 24
- 25
- 26
- 27
- 28
- 29
- 30

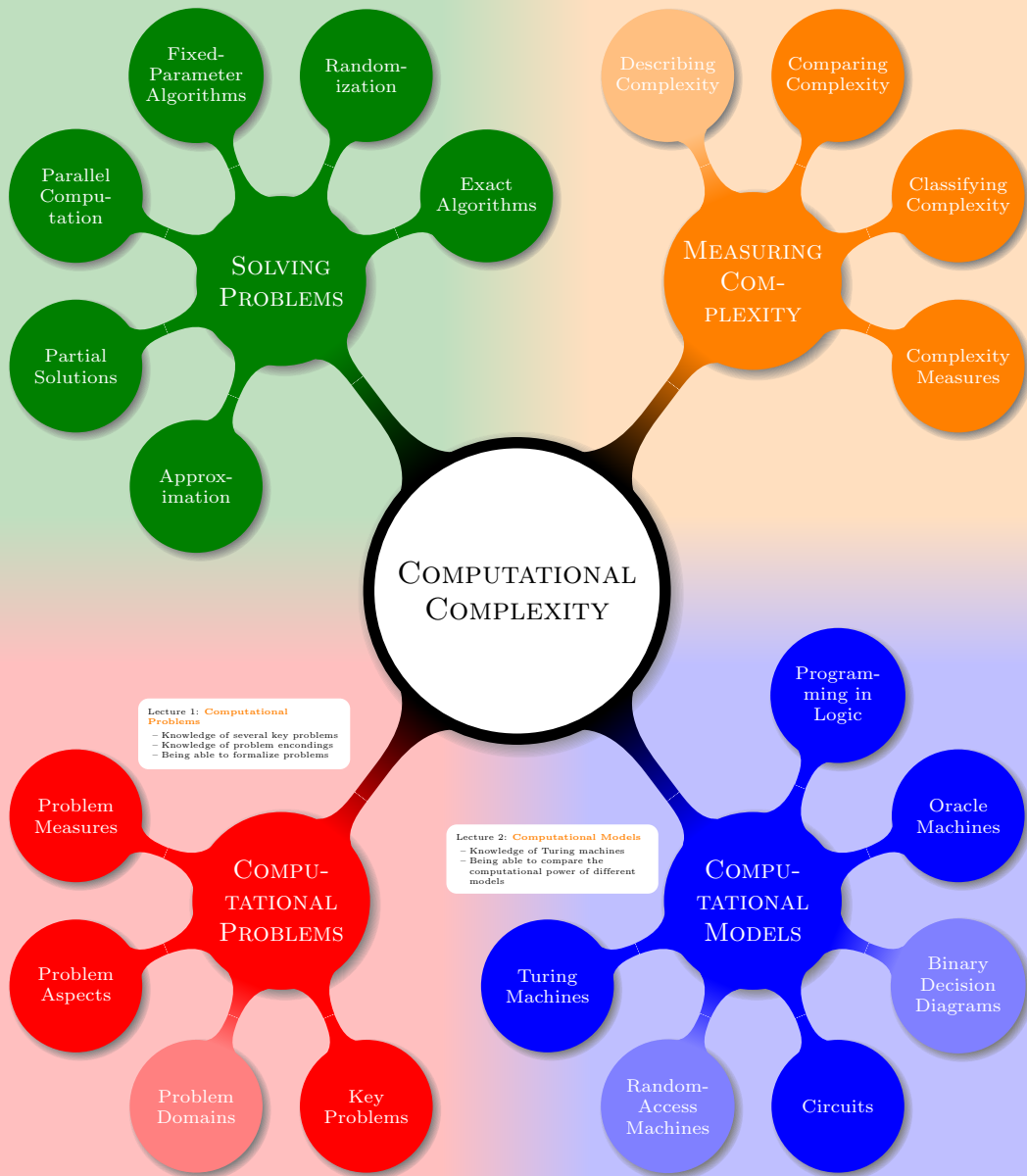

## 7 Guidelines on Graphics

The present section is not about PGF or TikZ, but about general guidelines and principles concerning the creation of graphics for scientific presentations, papers, and books.

The guidelines in this section come from different sources. Many of them are just what I would like to claim is “common sense,” some reflect my personal experience (though, hopefully, not my personal preferences), some come from books (the bibliography is still missing, sorry) on graphic design and typography. The most influential source are the brilliant books by Edward Tufte. While I do not agree with everything written in these books, many of Tufte’s arguments are so convincing that I decided to repeat them in the following guidelines.

The first thing you should ask yourself when someone presents a bunch of guidelines is: Should I really follow these guidelines? This is an important question, because there are good reasons not to follow general guidelines. The person who setup the guidelines may have had other objectives than you do. For example, a guideline might say “use the color red for emphasis.” While this guideline makes perfect sense for, say, a presentation using a projector, red “color” has the *opposite* effect of “emphasis” when printed using a black-and-white printer. Guidelines were almost always setup to address a specific situation. If you are not in this situation, following a guideline can do more harm than good.

The second thing you should be aware of is the basic rule of typography is: “Every rule can be broken, as long as you are *aware* that you are breaking a rule.” This rule also applies to graphics. Phrased differently, the basic rule states: “The only mistakes in typography are things done in ignorance.” When you are aware of a rule and when you decide that breaking the rule has a desirable effect, break the rule.

### 7.1 Planning the Time Needed for the Creation of Graphics

When you create a paper with numerous graphics, the time needed to create these graphics becomes an important factor. How much time should you calculate for the creation of graphics?

As a general rule, assume that a graphic will need as much time to create as would a text of the same length. For example, when I write a paper, I need about one hour per page for the first draft. Later, I need between two and four hours per page for revisions. Thus, I expect to need about half an hour for the creation of a *first draft* of a half page graphic. Later on, I expect another one to two hours before the final graphic is finished.

In many publications, even in good journals, the authors and editors have obviously invested a lot of time on the text, but seem to have spend about five minutes to create all of the graphics. Graphics often seem to have been added as an “afterthought” or look like a screen shot of whatever the authors’s statistical software shows them. As will be argued later on, the graphics that programs like GNUPLOT produce by default are of poor quality.

Creating informative graphics that help the reader and that fit together with the main text is a difficult, lengthy process.

- Treat graphics as first-class citizens of your papers. They deserve as much time and energy as the text does. Indeed, the creation of graphics might deserve *even more* time than the writing of the main text since more attention will be paid to the graphics and they will be looked at first.
- Plan as much time for the creation and revision of a graphic as you would plan for text of the same size.
- Difficult graphics with a high information density may require even more time.
- Very simple graphics will require less time, but most likely you do not want to have “very simple graphics” in your paper, anyway; just as you would not like to have a “very simple text” of the same size.

### 7.2 Workflow for Creating a Graphic

When you write a (scientific) paper, you will most likely follow the following pattern: You have some results/ideas that you would like to report about. The creation of the paper will typically start with compiling a rough outline. Then, the different sections are filled with text to create a first draft. This draft is then revised repeatedly until, often after substantial revision, a final paper results. In a good journal paper there is typically not be a single sentence that has survived unmodified from the first draft.

Creating a graphics follows the same pattern:

- Decide on what the graphic should communicate. Make this a conscious decision, that is, determine “What is the graphic supposed to tell the reader?”
- Create an “outline,” that is, the rough overall “shape” of the graphic, containing the most crucial elements. Often, it is useful to do this using pencil and paper.
- Fill out the finer details of the graphic to create a first draft.
- Revise the graphic repeatedly along with the rest of the paper.

### 7.3 Linking Graphics With the Main Text

Graphics can be placed at different places in a text. Either, they can be inlined, meaning they are somewhere “in the middle of the text” or they can be placed in standalone “figures.” Since printers (the people) like to have their pages “filled,” (both for aesthetic and economic reasons) standalone figures may traditionally be placed on pages in the document far removed from the main text that refers to them.  $\LaTeX$  and  $\TeX$  tend to encourage this “drifting away” of graphics for technical reasons.

When a graphic is inlined, it will more or less automatically be linked with the main text in the sense that the labels of the graphic will be implicitly explained by the surrounding text. Also, the main text will typically make it clear what the graphic is about and what is shown.

Quite differently, a standalone figure will often be viewed at a time when the main text that this graphic belongs to either has not yet been read or has been read some time ago. For this reason, you should follow the following guidelines when creating standalone figures:

- Standalone figures should have a caption than should make them “understandable by themselves.”

For example, suppose a graphic shows an example of the different stages of a quicksort algorithm. Then the figure’s caption should, at the very least, inform the reader that “The figure shows the different stages of the quicksort algorithm introduced on page xyz.” and not just “Quicksort algorithm.”

- A good caption adds as much context information as possible. For example, you could say: “The figure shows the different stages of the quicksort algorithm introduced on page xyz. In the first line, the pivot element 5 is chosen. This causes. . .” While this information can also be given in the main text, putting it in the caption will ensure that the context is kept. Do not feel afraid of a 5-line caption. (Your editor may hate you for this. Consider hating them back.)
- Reference the graphic in your main text as in “For an example of quicksort ‘in action,’ see Figure 2.1 on page xyz.”
- Most books on style and typography recommend that you do not use abbreviations as in “Fig. 2.1” but write “Figure 2.1.”

The main argument against abbreviations is that “a period is too valuable to waste it on an abbreviation.” The idea is that a period will make the reader assume that the sentence ends after “Fig” and it takes a “conscious backtracking” to realize that the sentence did not end after all.

The argument in favor of abbreviations is that they save space.

Personally, I am not really convinced by either argument. On the one hand, I have not yet seen any hard evidence that abbreviations slow readers down. On the other hand, abbreviating all “Figure” by “Fig.” is most unlikely to save even a single line in most documents. I avoid abbreviations.

### 7.4 Consistency Between Graphics and Text

Perhaps the most common “mistake” people do when creating graphics (remember that a “mistake” in design is always just “ignorance”) is to have a mismatch between the way their graphics look and the way their text looks.

It is quite common that authors use several different programs for creating the graphics of a paper. An author might produce some plots using `GNUPLOT`, a diagram using `XFIG`, and include an `.eps` graphic a coauthor contributed using some unknown program. All these graphics will, most likely, use different line widths, different fonts, and have different sizes. In addition, authors often use options like `[height=5cm]` when including graphics to scale them to some “nice size.”

If the same approach were taken to writing the main text, every section would be written in a different font at a different size. In some sections all theorems would be underlined, in another they would be printed

all in uppercase letters, and in another in red. In addition, the margins would be different on each page. Readers and editors would not tolerate a text if it were written in this fashion, but with graphics they often have to.

To create consistency between graphics and text, stick to the following guidelines:

- Do not scale graphics.

This means that when generating graphics using an external program, create them “at the right size.”

- Use the same font(s) both in graphics and the body text.
- Use the same line width in text and graphics.

The “line width” for normal text is the width of the stem of letters like T. For  $\text{\TeX}$ , this is usually 0.4pt. However, some journals will not accept graphics with a normal line width below 0.5pt.

- When using colors, use a consistent color coding in the text and in graphics. For example, if red is supposed to alert the reader to something in the main text, use red also in graphics for important parts of the graphic. If blue is used for structural elements like headlines and section titles, use blue also for structural elements of your graphic.

However, graphics may also use a logical intrinsic color coding. For example, no matter what colors you normally use, readers will generally assume, say, that the color green as “positive, go, ok” and red as “alert, warning, action.”

Creating consistency when using different graphic programs is almost impossible. For this reason, you should consider sticking to a single graphics program.

## 7.5 Labels in Graphics

Almost all graphics will contain labels, that is, pieces of text that explain parts of the graphics. When placing labels, stick to the following guidelines:

- Follow the rule of consistency when placing labels. You should do so in two ways: First, be consistent with the main text, that is, use the same font as the main text also for labels. Second, be consistent between labels, that is, if you format some labels in some particular way, format all labels in this way.
- In addition to using the same fonts in text and graphics, you should also use the same notation. For example, if you write  $1/2$  in your main text, also use “ $1/2$ ” as labels in graphics, not “0.5”. A  $\pi$  is a “ $\pi$ ” and not “3.141”. Finally,  $e^{-i\pi}$  is “ $e^{-i\pi}$ ”, not “ $-1$ ”, let alone “-1”.
- Labels should be legible. They should not only have a reasonably large size, they also should not be obscured by lines or other text. This also applies to of lines and text *behind* the labels.
- Labels should be “in place.” Whenever there is enough space, labels should be placed next to the thing they label. Only if necessary, add a (subdued) line from the label to the labeled object. Try to avoid labels that only reference explanations in external legends. Reader have to jump back and forth between the explanation and the object that is described.
- Consider subduing “unimportant” labels using, for example, a gray color. This will keep the focus on the actual graphic.

## 7.6 Plots and Charts

One of the most frequent kind of graphics, especially in scientific papers, are *plots*. They come in a large variety, including simple line plots, parametric plots, three dimensional plots, pie charts, and many more.

Unfortunately, plots are notoriously hard to get right. Partly, the default settings of programs like GNUPLOT or Excel are to blame for this since these programs make it very convenient to create bad plots.

The first question you should ask yourself when creating a plot is, Are there enough data points to merit a plot? If the answer is “not really,” use a table.

A typical situation where a plot is unnecessary is when people present a few numbers in a bar diagram. Here is a real-life example: At the end of a seminar a lecturer asked the participants for feedback. Of the 50 participants, 30 returned the feedback form. According to the feedback, three participants considered the

seminar “very good,” nine considered it “good,” ten “ok,” eight “bad,” and no one thought that the seminar was “very bad.”

A simple way of summing up this information is the following table:

| <i>Rating given</i> | <i>Participants (out of 50)<br/>who gave this rating</i> | <i>Percentage</i> |
|---------------------|----------------------------------------------------------|-------------------|
| “very good”         | 3                                                        | 6%                |
| “good”              | 9                                                        | 18%               |
| “ok”                | 10                                                       | 20%               |
| “bad”               | 8                                                        | 16%               |
| “very bad”          | 0                                                        | 0%                |
| none                | 20                                                       | 40%               |

What the lecturer did was to visualize the data using a 3D bar diagram. It looked like this (except that in reality the numbers were typeset using some extremely low-resolution bitmap font and were near-unreadable):

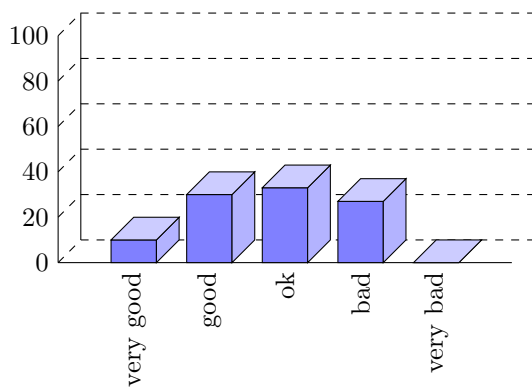

Both the table and the “plot” have about the same size. If your first thought is “the graphic looks nicer than the table,” try to answer the following questions based on the information in the table or in the graphic:

1. How many participants were there?
2. How many participants returned the feedback form?
3. What percentage of the participants returned the feedback form?
4. How many participants checked “very good”?
5. What percentage out of all participants checked “very good”?
6. Did more than a quarter of the participants check “bad” or “very bad”?
7. What percentage of the participants that returned the form checked “very good”?

Sadly, the graphic does not allow us to answer *a single one of these questions*. The table answers all of them directly, except for the last one. In essence, the information density of the graphic is very nearly zero. The table has a much higher information density; despite the fact that it uses quite a lot of white space to present a few numbers. Here is the list of things that went wrong with the 3D-bar diagram:

- The whole graphic is dominated by irritating background lines.
- It is not clear what the numbers at the left mean; presumably percentages, but it might also be the absolute number of participants.
- The labels at the bottom are rotated, making them hard to read.  
(In the real presentation that I saw, the text was rendered at a very low resolution with about 10 by 6 pixels per letter with wrong kerning, making the rotated text almost impossible to read.)
- The third dimension adds complexity to the graphic without adding information.

- The three dimensional setup makes it much harder to gauge the height of the bars correctly. Consider the “bad” bar. It the number this bar stands for more than 20 or less? While the front of the bar is below the 20 line, the back of the bar (which counts) is above.
- It is impossible to tell which numbers are represented by the bars. Thus, the bars needlessly hide the information these bars are all about.
- What do the bar heights add up to? Is it 100% or 60%?
- Does the bar for “very bad” represent 0 or 1?
- Why are the bars blue?

You might argue that in the example the exact numbers are not important for the graphic. The important things is the “message,” which is that there are more “very good” and “good” ratings than “bad” and “very bad.” However, to convey this message either use a sentence that says so or use a graphic that conveys this message more clearly:

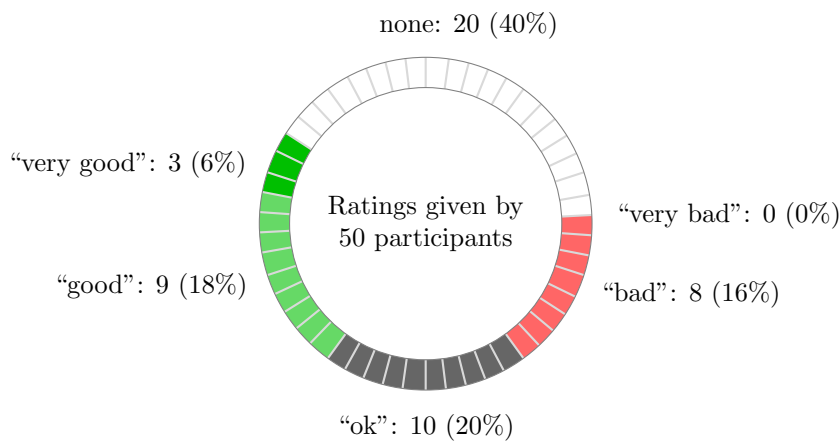

The above graphic has about the same information density as the table (about the same size and the same numbers are shown). In addition, one can directly “see” that there are more good or very good ratings than bad ones. One can also “see” that the number of people who gave no rating at all is not negligible, which is quite common for feedback forms.

Charts are not always a good idea. Let us look at an example that I redrew from a pie chart in *Die Zeit*, June 4th, 2005:

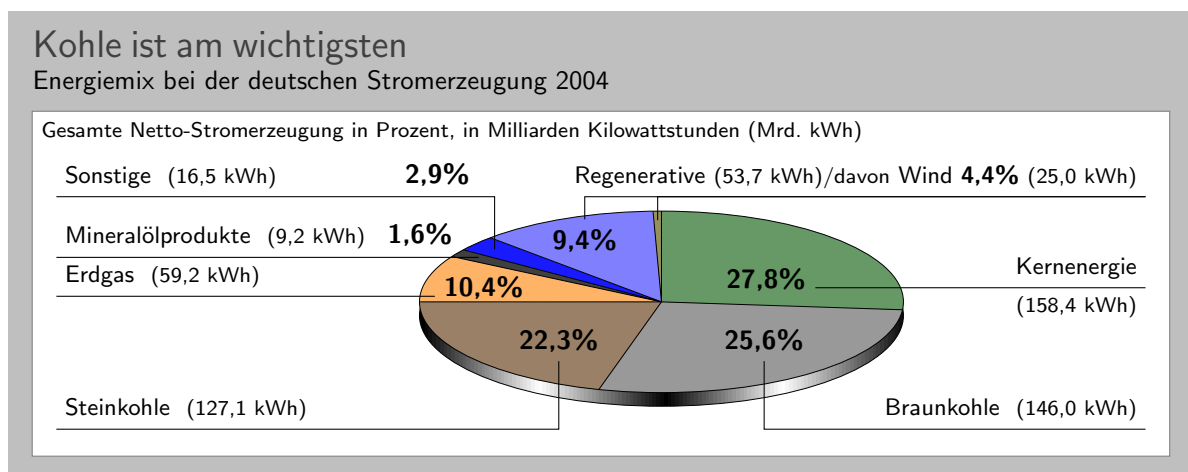

This graphic has been redrawn in TikZ, but the original looks almost exactly the same. At first sight, the graphic looks “nice and informative,” but there are a lot of things that went wrong:

- The chart is three dimensional. However, the shadings add nothing “information-wise,” at best, they distract.

- In a 3D-pie-chart the relative sizes are very strongly distorted. For example, the area taken up by the gray color of “Braunkohle” is larger than the area taken up by the green color of “Kernenergie” *despite the fact that the percentage of Braunkohle is less than the percentage of Kernenergie.*

- The 3D-distortion gets worse for small areas. The area of “Regenerative” somewhat larger than the area of “Erdgas.” The area of “Wind” is slightly smaller than the area of “Mineralölprodukte” *although the percentage of Wind is nearly three times larger than the percentage of Mineralölprodukte.*

In the last case, the different sizes are only partly due to distortion. The designer(s) of the original graphic have also made the “Wind” slice too small, even taking distortion into account. (Just compare the size of “Wind” to “Regenerative” in general.)

- According to its caption, this chart is supposed to inform us that coal was the most important energy source in Germany in 2004. Ignoring the strong distortions caused by the superfluous and misleading 3D-setup, it takes quite a while for this message to get across.

Coal as an energy source is split up into two slices: one for “Steinkohle” and one for “Braunkohle” (two different kinds of coal). When you add them up, you see that the whole lower half of the pie chart is taken up by coal.

The two areas for the different kinds of coal are not visually linked at all. Rather, two different colors are used, the labels are on different sides of the graphic. By comparison, “Regenerative” and “Wind” are very closely linked.

- The color coding of the graphic follows no logical pattern at all. Why is nuclear energy green? Regenerative energy is light blue, “other sources” are blue. It seems more like a joke that the area for “Braunkohle” (which literally translates to “brown coal”) is stone gray, while the area for “Steinkohle” (which literally translates to “stone coal”) is brown.
- The area with the lightest color is used for “Erdgas.” This area stands out most because of the brighter color. However, for this chart “Erdgas” is not really important at all.

Edward Tufte calls graphics like the above “chart junk.” (I am happy to announce, however, that *Die Zeit* has stopped using 3D pie charts and their information graphics have got somewhat better.)

Here are a few recommendations that may help you avoid producing chart junk:

- Do not use 3D pie charts. They are *evil*.
- Consider using a table instead of a pie chart.
- Do not apply colors randomly; use them to direct the readers’s focus and to group things.
- Do not use background patterns, like a crosshatch or diagonal lines, instead of colors. They distract. Background patterns in information graphics are *evil*.

## 7.7 Attention and Distraction

Pick up your favorite fiction novel and have a look at a typical page. You will notice that the page is very uniform. Nothing is there to distract the reader while reading; no large headlines, no bold text, no large white areas. Indeed, even when the author does wish to emphasize something, this is done using italic letters. Such letters blend nicely with the main text—at a distance you will not be able to tell whether a page contains italic letters, but you would notice a single bold word immediately. The reason novels are typeset this way is the following paradigm: Avoid distractions.

Good typography (like good organization) is something you do *not* notice. The job of typography is to make reading the text, that is, “absorbing” its information content, as effortless as possible. For a novel, readers absorb the content by reading the text line-by-line, as if they were listening to someone telling the story. In this situation anything on the page that distracts the eye from going quickly and evenly from line to line will make the text harder to read.

Now, pick up your favorite weekly magazine or newspaper and have a look at a typical page. You will notice that there is quite a lot “going on” on the page. Fonts are used at different sizes and in different arrangements, the text is organized in narrow columns, typically interleaved with pictures. The reason magazines are typeset in this way is another paradigm: Steer attention.

Readers will not read a magazine like a novel. Instead of reading a magazine line-by-line, we use headlines and short abstracts to check whether we want to read a certain article or not. The job of typography is to



steer our attention to these abstracts and headlines, first. Once we have decided that we want to read an article, however, we no longer tolerate distractions, which is why the main text of articles is typeset exactly the same way as a novel.

The two principles “avoid distractions” and “steer attention” also apply to graphics. When you design a graphic, you should eliminate everything that will “distract the eye.” At the same time, you should try to actively help the reader “through the graphic” by using fonts/colors/line widths to highlight different parts.

Here is a non-exhaustive list of things that can distract readers:

- Strong contrasts will always be registered first by the eye. For example, consider the following two grids:

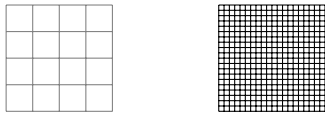

Even though the left grid comes first in English reading order, the right one is much more likely to be seen first: The white-to-black contrast is higher than the gray-to-white contrast. In addition, there are more “places” adding to the overall contrast in the right grid.

Things like grids and, more generally, help lines usually should not grab the attention of the readers and, hence, should be typeset with a low contrast to the background. Also, a loosely-spaced grid is less distracting than a very closely-spaced grid.

- Dashed lines create many points at which there is black-to-white contrast. Dashed or dotted lines can be very distracting and, hence, should be avoided in general.

Do not use different dashing patterns to differentiate curves in plots. You lose data points this way and the eye is not particularly good at “grouping things according to a dashing pattern.” The eye is *much* better at grouping things according to colors.

- Background patterns filling an area using diagonal lines or horizontal and vertical lines or just dots are almost always distracting and, usually, serve no real purpose.
- Background images and shadings distract and only seldom add anything of importance to a graphic.
- Cute little cliparts can easily draw attention away from the data.

## Part II

# Installation and Configuration

by *Till Tantau*

This part explains how the system is installed. Typically, someone has already done so for your system, so this part can be skipped; but if this is not the case and you are the poor fellow who has to do the installation, read the present part.

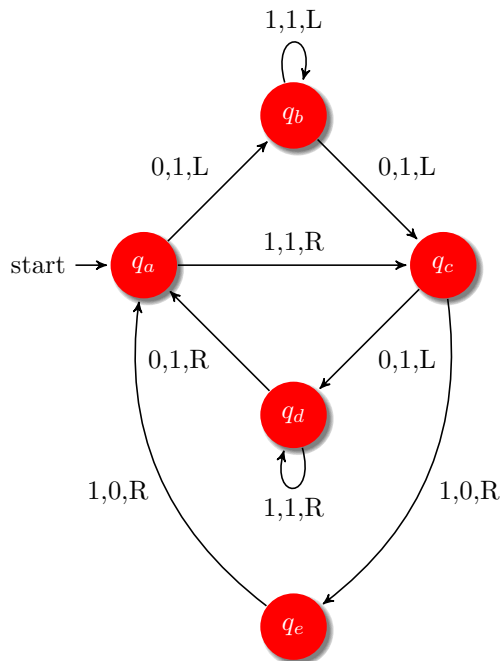

The current candidate for the busy beaver for five states. It is presumed that this Turing machine writes a maximum number of 1's before halting among all Turing machines with five states and the tape alphabet  $\{0, 1\}$ . Proving this conjecture is an open research problem.

```
\begin{tikzpicture}[->,>=stealth',shorten >=1pt,auto,node distance=2.8cm,on grid,semithick,
every state/.style={fill=red,draw=none,circular drop shadow,text=white}]

\node[initial,state] (A) {$q_a$};
\node[state] (B) [above right=of A] {$q_b$};
\node[state] (D) [below right=of A] {$q_d$};
\node[state] (C) [below right=of B] {$q_c$};
\node[state] (E) [below=of D] {$q_e$};

\path (A) edge node {0,1,L} (B)
edge node {1,1,R} (C)
(B) edge [loop above] node {1,1,L} (B)
edge node {0,1,L} (C)
(C) edge node {0,1,L} (D)
edge [bend left] node {1,0,R} (E)
(D) edge [loop below] node {1,1,R} (D)
edge node {0,1,R} (A)
(E) edge [bend left] node {1,0,R} (A);

\node [right=1cm,text width=8cm] at (C)
{
The current candidate for the busy beaver for five states. It is
presumed that this Turing machine writes a maximum number of
1's before halting among all Turing machines with five states
and the tape alphabet  $\{0, 1\}$ . Proving this conjecture is an
open research problem.
};
\end{tikzpicture}
```

## 8 Installation

There are different ways of installing PGF, depending on your system and needs, and you may need to install other packages as well as, see below. Before installing, you may wish to review the licenses under which the package is distributed, see Section 9.

Typically, the package will already be installed on your system. Naturally, in this case you do not need to worry about the installation process at all and you can skip the rest of this section.

### 8.1 Package and Driver Versions

This documentation is part of version 2.00-cvs of the PGF package. In order to run PGF, you need a reasonably recent T<sub>E</sub>X installation. When using L<sup>A</sup>T<sub>E</sub>X, you need the following packages installed (newer versions should also work):

- `xcolor` version 2.00.

With plain T<sub>E</sub>X, `xcolor` is not needed, but you obviously do not get its (full) functionality.

Currently, PGF supports the following backend drivers:

- `pdftex` version 0.14 or higher. Earlier versions do not work.
- `dvips` version 5.94a or higher. Earlier versions may also work.

For inter-picture connections, you need process pictures using `pdftex` version 1.40 or higher running in DVI mode.

- `dvipdfm` version 0.13.2c or higher. Earlier versions may also work.

For inter-picture connections, you need process pictures using `pdftex` version 1.40 or higher running in DVI mode.

- `tex4ht` version 2003-05-05 or higher. Earlier versions may also work.
- `vtex` version 8.46a or higher. Earlier versions may also work.
- `textures` version 2.1 or higher. Earlier versions may also work.
- `xetex` version 0.996 or higher. Earlier versions may also work.

Currently, PGF supports the following formats:

- `latex` with complete functionality.
- `plain` with complete functionality, except for graphics inclusion, which works only for pdfT<sub>E</sub>X.
- `context` with complete functionality, except for graphics inclusion, which works only for pdfT<sub>E</sub>X.

For more details, see Section 10.

### 8.2 Installing Prebundled Packages

I do not create or manage prebundled packages of PGF, but, fortunately, nice other people do. I cannot give detailed instructions on how to install these packages, since I do not manage them, but I *can* tell you where to find them. If you have a problem with installing, you might wish to have a look at the Debian page or the MikT<sub>E</sub>X page first.

#### 8.2.1 Debian

The command “`aptitude install pgf`” should do the trick. Sit back and relax. In detail, the following packages are installed:

<http://packages.debian.org/pgf>  
<http://packages.debian.org/latex-xcolor>

#### 8.2.2 MiKTeX

For MiK<sub>T</sub>E<sub>X</sub>, use the update wizard to install the (latest versions of the) packages called `pgf` and `xcolor`.

## 8.3 Installation in a texmf Tree

For a permanent installation, you place the files of the the PGF package in an appropriate `texmf` tree.

When you ask  $\TeX$  to use a certain class or package, it usually looks for the necessary files in so-called `texmf` trees. These trees are simply huge directories that contain these files. By default,  $\TeX$  looks for files in three different `texmf` trees:

- The root `texmf` tree, which is usually located at `/usr/share/texmf/` or `c:\texmf\` or somewhere similar.
- The local `texmf` tree, which is usually located at `/usr/local/share/texmf/` or `c:\localtexmf\` or somewhere similar.
- Your personal `texmf` tree, which is usually located in your home directory at `~/texmf/` or `~/Library/texmf/`.

You should install the packages either in the local tree or in your personal tree, depending on whether you have write access to the local tree. Installation in the root tree can cause problems, since an update of the whole  $\TeX$  installation will replace this whole tree.

### 8.3.1 Installation that Keeps Everything Together

Once you have located the right `texmf` tree, you must decide whether you want to install PGF in such a way that “all its files are kept in one place” or whether you want to be “TDS-compliant,” where TDS means “ $\TeX$  directory structure.”

If you want to keep “everything in one place,” inside the `texmf` tree that you have chosen create a sub-sub-directory called `texmf/tex/generic/pgf` or `texmf/tex/generic/pgf-2.00-cvs`, if you prefer. Then place all files of the `pgf` package in this directory. Finally, rebuild  $\TeX$ 's filename database. This is done by running the command `texhash` or `mktexlsr` (they are the same). In Mik $\TeX$ , there is a menu option to do this.

### 8.3.2 Installation that is TDS-Compliant

While the above installation process is the most “natural” one and although I would like to recommend it since it makes updating and managing the PGF package easy, it is not TDS-compliant. If you want to be TDS-compliant, proceed as follows: (If you do not know what TDS-compliant means, you probably do not want to be TDS-compliant.)

The `.tar` file of the `pgf` package contains the following files and directories at its root: `README`, `doc`, `generic`, `plain`, and `latex`. You should “merge” each of the four directories with the following directories `texmf/doc`, `texmf/tex/generic`, `texmf/tex/plain`, and `texmf/tex/latex`. For example, in the `.tar` file the `doc` directory contains just the directory `pgf`, and this directory has to be moved to `texmf/doc/pgf`. The root `README` file can be ignored since it is reproduced in `doc/pgf/README`.

You may also consider keeping everything in one place and using symbolic links to point from the TDS-compliant directories to the central installation.

For a more detailed explanation of the standard installation process of packages, you might wish to consult <http://www.ctan.org/installationadvice/>. However, note that the PGF package does not come with a `.ins` file (simply skip that part).

## 8.4 Updating the Installation

To update your installation from a previous version, all you need to do is to replace everything in the directory `texmf/tex/generic/pgf` with the files of the new version (or in all the directories where `pgf` was installed, if you chose a TDS-compliant installation). The easiest way to do this is to first delete the old version and then proceed as described above. Sometimes, there are changes in the syntax of certain command from version to version. If things no longer work that used to work, you may wish to have a look at the release notes and at the change log.

## 9 Licenses and Copyright

### 9.1 Which License Applies?

Different parts of the PGF package are distributed under different licenses:

1. The *code* of the package is dual-license. This means that you can decide which license you wish to use when using the PGF package. The two options are:
  - (a) You can use the GNU Public License, version 2.
  - (b) You can use the L<sup>A</sup>T<sub>E</sub>X Project Public License, version 1.3c.
2. The *documentation* of the package is also dual-license. Again, you can choose between two options:
  - (a) You can use the GNU Free Documentation License, version 1.2.
  - (b) You can use the L<sup>A</sup>T<sub>E</sub>X Project Public License, version 1.3c.

The “documentation of the package” refers to all files in the subdirectory `doc` of the `pgf` package. A detailed listing can be found in the file `doc/generic/pgf/licenses/manifest-documentation.txt`. All files in other directories are part of the “code of the package.” A detailed listing can be found in the file `doc/generic/pgf/licenses/manifest-code.txt`.

In the rest of this section, the licenses are presented. The following text is copyrighted, see the plain text versions of these licenses in the directory `doc/generic/pgf/licenses` for details.

The example picture used in this manual, the Brave GNU World logo, is taken from the Brave GNU World homepage, where it is copyrighted as follows: “Copyright (C) 1999, 2000, 2001, 2002, 2003, 2004 Georg C. F. Greve. Permission is granted to make and distribute verbatim copies of this transcript as long as the copyright and this permission notice appear.”

### 9.2 The GNU Public License, Version 2

#### 9.2.1 Preamble

The licenses for most software are designed to take away your freedom to share and change it. By contrast, the GNU General Public License is intended to guarantee your freedom to share and change free software—to make sure the software is free for all its users. This General Public License applies to most of the Free Software Foundation’s software and to any other program whose authors commit to using it. (Some other Free Software Foundation software is covered by the GNU Library General Public License instead.) You can apply it to your programs, too.

When we speak of free software, we are referring to freedom, not price. Our General Public Licenses are designed to make sure that you have the freedom to distribute copies of free software (and charge for this service if you wish), that you receive source code or can get it if you want it, that you can change the software or use pieces of it in new free programs; and that you know you can do these things.

To protect your rights, we need to make restrictions that forbid anyone to deny you these rights or to ask you to surrender the rights. These restrictions translate to certain responsibilities for you if you distribute copies of the software, or if you modify it.

For example, if you distribute copies of such a program, whether gratis or for a fee, you must give the recipients all the rights that you have. You must make sure that they, too, receive or can get the source code. And you must show them these terms so they know their rights.

We protect your rights with two steps: (1) copyright the software, and (2) offer you this license which gives you legal permission to copy, distribute and/or modify the software.

Also, for each author’s protection and ours, we want to make certain that everyone understands that there is no warranty for this free software. If the software is modified by someone else and passed on, we want its recipients to know that what they have is not the original, so that any problems introduced by others will not reflect on the original authors’ reputations.

Finally, any free program is threatened constantly by software patents. We wish to avoid the danger that redistributors of a free program will individually obtain patent licenses, in effect making the program proprietary. To prevent this, we have made it clear that any patent must be licensed for everyone’s free use or not licensed at all.

The precise terms and conditions for copying, distribution and modification follow.

### 9.2.2 Terms and Conditions For Copying, Distribution and Modification

0. This License applies to any program or other work which contains a notice placed by the copyright holder saying it may be distributed under the terms of this General Public License. The “Program”, below, refers to any such program or work, and a “work based on the Program” means either the Program or any derivative work under copyright law: that is to say, a work containing the Program or a portion of it, either verbatim or with modifications and/or translated into another language. (Hereinafter, translation is included without limitation in the term “modification”.) Each licensee is addressed as “you”.

Activities other than copying, distribution and modification are not covered by this License; they are outside its scope. The act of running the Program is not restricted, and the output from the Program is covered only if its contents constitute a work based on the Program (independent of having been made by running the Program). Whether that is true depends on what the Program does.

1. You may copy and distribute verbatim copies of the Program’s source code as you receive it, in any medium, provided that you conspicuously and appropriately publish on each copy an appropriate copyright notice and disclaimer of warranty; keep intact all the notices that refer to this License and to the absence of any warranty; and give any other recipients of the Program a copy of this License along with the Program.

You may charge a fee for the physical act of transferring a copy, and you may at your option offer warranty protection in exchange for a fee.

2. You may modify your copy or copies of the Program or any portion of it, thus forming a work based on the Program, and copy and distribute such modifications or work under the terms of Section 1 above, provided that you also meet all of these conditions:

- (a) You must cause the modified files to carry prominent notices stating that you changed the files and the date of any change.
- (b) You must cause any work that you distribute or publish, that in whole or in part contains or is derived from the Program or any part thereof, to be licensed as a whole at no charge to all third parties under the terms of this License.
- (c) If the modified program normally reads commands interactively when run, you must cause it, when started running for such interactive use in the most ordinary way, to print or display an announcement including an appropriate copyright notice and a notice that there is no warranty (or else, saying that you provide a warranty) and that users may redistribute the program under these conditions, and telling the user how to view a copy of this License. (Exception: if the Program itself is interactive but does not normally print such an announcement, your work based on the Program is not required to print an announcement.)

These requirements apply to the modified work as a whole. If identifiable sections of that work are not derived from the Program, and can be reasonably considered independent and separate works in themselves, then this License, and its terms, do not apply to those sections when you distribute them as separate works. But when you distribute the same sections as part of a whole which is a work based on the Program, the distribution of the whole must be on the terms of this License, whose permissions for other licensees extend to the entire whole, and thus to each and every part regardless of who wrote it.

Thus, it is not the intent of this section to claim rights or contest your rights to work written entirely by you; rather, the intent is to exercise the right to control the distribution of derivative or collective works based on the Program.

In addition, mere aggregation of another work not based on the Program with the Program (or with a work based on the Program) on a volume of a storage or distribution medium does not bring the other work under the scope of this License.

3. You may copy and distribute the Program (or a work based on it, under Section 2) in object code or executable form under the terms of Sections 1 and 2 above provided that you also do one of the following:

- (a) Accompany it with the complete corresponding machine-readable source code, which must be distributed under the terms of Sections 1 and 2 above on a medium customarily used for software interchange; or,

- (b) Accompany it with a written offer, valid for at least three years, to give any third party, for a charge no more than your cost of physically performing source distribution, a complete machine-readable copy of the corresponding source code, to be distributed under the terms of Sections 1 and 2 above on a medium customarily used for software interchange; or,
- (c) Accompany it with the information you received as to the offer to distribute corresponding source code. (This alternative is allowed only for noncommercial distribution and only if you received the program in object code or executable form with such an offer, in accord with Subsubsection b above.)

The source code for a work means the preferred form of the work for making modifications to it. For an executable work, complete source code means all the source code for all modules it contains, plus any associated interface definition files, plus the scripts used to control compilation and installation of the executable. However, as a special exception, the source code distributed need not include anything that is normally distributed (in either source or binary form) with the major components (compiler, kernel, and so on) of the operating system on which the executable runs, unless that component itself accompanies the executable.

If distribution of executable or object code is made by offering access to copy from a designated place, then offering equivalent access to copy the source code from the same place counts as distribution of the source code, even though third parties are not compelled to copy the source along with the object code.

4. You may not copy, modify, sublicense, or distribute the Program except as expressly provided under this License. Any attempt otherwise to copy, modify, sublicense or distribute the Program is void, and will automatically terminate your rights under this License. However, parties who have received copies, or rights, from you under this License will not have their licenses terminated so long as such parties remain in full compliance.
5. You are not required to accept this License, since you have not signed it. However, nothing else grants you permission to modify or distribute the Program or its derivative works. These actions are prohibited by law if you do not accept this License. Therefore, by modifying or distributing the Program (or any work based on the Program), you indicate your acceptance of this License to do so, and all its terms and conditions for copying, distributing or modifying the Program or works based on it.
6. Each time you redistribute the Program (or any work based on the Program), the recipient automatically receives a license from the original licensor to copy, distribute or modify the Program subject to these terms and conditions. You may not impose any further restrictions on the recipients' exercise of the rights granted herein. You are not responsible for enforcing compliance by third parties to this License.
7. If, as a consequence of a court judgment or allegation of patent infringement or for any other reason (not limited to patent issues), conditions are imposed on you (whether by court order, agreement or otherwise) that contradict the conditions of this License, they do not excuse you from the conditions of this License. If you cannot distribute so as to satisfy simultaneously your obligations under this License and any other pertinent obligations, then as a consequence you may not distribute the Program at all. For example, if a patent license would not permit royalty-free redistribution of the Program by all those who receive copies directly or indirectly through you, then the only way you could satisfy both it and this License would be to refrain entirely from distribution of the Program.

If any portion of this section is held invalid or unenforceable under any particular circumstance, the balance of the section is intended to apply and the section as a whole is intended to apply in other circumstances.

It is not the purpose of this section to induce you to infringe any patents or other property right claims or to contest validity of any such claims; this section has the sole purpose of protecting the integrity of the free software distribution system, which is implemented by public license practices. Many people have made generous contributions to the wide range of software distributed through that system in reliance on consistent application of that system; it is up to the author/donor to decide if he or she is willing to distribute software through any other system and a licensee cannot impose that choice.

This section is intended to make thoroughly clear what is believed to be a consequence of the rest of this License.

8. If the distribution and/or use of the Program is restricted in certain countries either by patents or by copyrighted interfaces, the original copyright holder who places the Program under this License may add an explicit geographical distribution limitation excluding those countries, so that distribution is permitted only in or among countries not thus excluded. In such case, this License incorporates the limitation as if written in the body of this License.
9. The Free Software Foundation may publish revised and/or new versions of the General Public License from time to time. Such new versions will be similar in spirit to the present version, but may differ in detail to address new problems or concerns.

Each version is given a distinguishing version number. If the Program specifies a version number of this License which applies to it and “any later version”, you have the option of following the terms and conditions either of that version or of any later version published by the Free Software Foundation. If the Program does not specify a version number of this License, you may choose any version ever published by the Free Software Foundation.

10. If you wish to incorporate parts of the Program into other free programs whose distribution conditions are different, write to the author to ask for permission. For software which is copyrighted by the Free Software Foundation, write to the Free Software Foundation; we sometimes make exceptions for this. Our decision will be guided by the two goals of preserving the free status of all derivatives of our free software and of promoting the sharing and reuse of software generally.

### 9.2.3 No Warranty

10. Because the program is licensed free of charge, there is no warranty for the program, to the extent permitted by applicable law. Except when otherwise stated in writing the copyright holders and/or other parties provide the program “as is” without warranty of any kind, either expressed or implied, including, but not limited to, the implied warranties of merchantability and fitness for a particular purpose. The entire risk as to the quality and performance of the program is with you. Should the program prove defective, you assume the cost of all necessary servicing, repair or correction.
11. In no event unless required by applicable law or agreed to in writing will any copyright holder, or any other party who may modify and/or redistribute the program as permitted above, be liable to you for damages, including any general, special, incidental or consequential damages arising out of the use or inability to use the program (including but not limited to loss of data or data being rendered inaccurate or losses sustained by you or third parties or a failure of the program to operate with any other programs), even if such holder or other party has been advised of the possibility of such damages.

## 9.3 The L<sup>A</sup>T<sub>E</sub>X Project Public License, Version 1.3c 2006-05-20

### 9.3.1 Preamble

The L<sup>A</sup>T<sub>E</sub>X Project Public License (LPPL) is the primary license under which the the L<sup>A</sup>T<sub>E</sub>X kernel and the base L<sup>A</sup>T<sub>E</sub>X packages are distributed.

You may use this license for any work of which you hold the copyright and which you wish to distribute. This license may be particularly suitable if your work is T<sub>E</sub>X-related (such as a L<sup>A</sup>T<sub>E</sub>X package), but it is written in such a way that you can use it even if your work is unrelated to T<sub>E</sub>X.

The section ‘WHETER AND HOW TO DISTRIBUTE WORKS UNDER THIS LICENSE’, below, gives instructions, examples, and recommendations for authors who are considering distributing their works under this license.

This license gives conditions under which a work may be distributed and modified, as well as conditions under which modified versions of that work may be distributed.

We, the L<sup>A</sup>T<sub>E</sub>X3 Project, believe that the conditions below give you the freedom to make and distribute modified versions of your work that conform with whatever technical specifications you wish while maintaining the availability, integrity, and reliability of that work. If you do not see how to achieve your goal while meeting these conditions, then read the document ‘`cfgguide.tex`’ and ‘`modguide.tex`’ in the base L<sup>A</sup>T<sub>E</sub>X distribution for suggestions.

### 9.3.2 Definitions

In this license document the following terms are used:

**Work** Any work being distributed under this License.



**Derived Work** Any work that under any applicable law is derived from the Work.

**Modification** Any procedure that produces a Derived Work under any applicable law – for example, the production of a file containing an original file associated with the Work or a significant portion of such a file, either verbatim or with modifications and/or translated into another language.

**Modify** To apply any procedure that produces a Derived Work under any applicable law.

**Distribution** Making copies of the Work available from one person to another, in whole or in part. Distribution includes (but is not limited to) making any electronic components of the Work accessible by file transfer protocols such as FTP or HTTP or by shared file systems such as Sun’s Network File System (NFS).

**Compiled Work** A version of the Work that has been processed into a form where it is directly usable on a computer system. This processing may include using installation facilities provided by the Work, transformations of the Work, copying of components of the Work, or other activities. Note that modification of any installation facilities provided by the Work constitutes modification of the Work.

**Current Maintainer** A person or persons nominated as such within the Work. If there is no such explicit nomination then it is the ‘Copyright Holder’ under any applicable law.

**Base Interpreter** A program or process that is normally needed for running or interpreting a part or the whole of the Work.

A Base Interpreter may depend on external components but these are not considered part of the Base Interpreter provided that each external component clearly identifies itself whenever it is used interactively. Unless explicitly specified when applying the license to the Work, the only applicable Base Interpreter is a ‘L<sup>A</sup>T<sub>E</sub>X-Format’ or in the case of files belonging to the ‘L<sup>A</sup>T<sub>E</sub>X-format’ a program implementing the ‘T<sub>E</sub>X language’.

### 9.3.3 Conditions on Distribution and Modification

1. Activities other than distribution and/or modification of the Work are not covered by this license; they are outside its scope. In particular, the act of running the Work is not restricted and no requirements are made concerning any offers of support for the Work.
2. You may distribute a complete, unmodified copy of the Work as you received it. Distribution of only part of the Work is considered modification of the Work, and no right to distribute such a Derived Work may be assumed under the terms of this clause.
3. You may distribute a Compiled Work that has been generated from a complete, unmodified copy of the Work as distributed under Clause 2 above, as long as that Compiled Work is distributed in such a way that the recipients may install the Compiled Work on their system exactly as it would have been installed if they generated a Compiled Work directly from the Work.
4. If you are the Current Maintainer of the Work, you may, without restriction, modify the Work, thus creating a Derived Work. You may also distribute the Derived Work without restriction, including Compiled Works generated from the Derived Work. Derived Works distributed in this manner by the Current Maintainer are considered to be updated versions of the Work.
5. If you are not the Current Maintainer of the Work, you may modify your copy of the Work, thus creating a Derived Work based on the Work, and compile this Derived Work, thus creating a Compiled Work based on the Derived Work.
6. If you are not the Current Maintainer of the Work, you may distribute a Derived Work provided the following conditions are met for every component of the Work unless that component clearly states in the copyright notice that it is exempt from that condition. Only the Current Maintainer is allowed to add such statements of exemption to a component of the Work.
  - (a) If a component of this Derived Work can be a direct replacement for a component of the Work when that component is used with the Base Interpreter, then, wherever this component of the Work identifies itself to the user when used interactively with that Base Interpreter, the replacement component of this Derived Work clearly and unambiguously identifies itself as a modified version of this component to the user when used interactively with that Base Interpreter.

- (b) Every component of the Derived Work contains prominent notices detailing the nature of the changes to that component, or a prominent reference to another file that is distributed as part of the Derived Work and that contains a complete and accurate log of the changes.
  - (c) No information in the Derived Work implies that any persons, including (but not limited to) the authors of the original version of the Work, provide any support, including (but not limited to) the reporting and handling of errors, to recipients of the Derived Work unless those persons have stated explicitly that they do provide such support for the Derived Work.
  - (d) You distribute at least one of the following with the Derived Work:
    - i. A complete, unmodified copy of the Work; if your distribution of a modified component is made by offering access to copy the modified component from a designated place, then offering equivalent access to copy the Work from the same or some similar place meets this condition, even though third parties are not compelled to copy the Work along with the modified component;
    - ii. Information that is sufficient to obtain a complete, unmodified copy of the Work.
7. If you are not the Current Maintainer of the Work, you may distribute a Compiled Work generated from a Derived Work, as long as the Derived Work is distributed to all recipients of the Compiled Work, and as long as the conditions of Clause 6, above, are met with regard to the Derived Work.
  8. The conditions above are not intended to prohibit, and hence do not apply to, the modification, by any method, of any component so that it becomes identical to an updated version of that component of the Work as it is distributed by the Current Maintainer under Clause 4, above.
  9. Distribution of the Work or any Derived Work in an alternative format, where the Work or that Derived Work (in whole or in part) is then produced by applying some process to that format, does not relax or nullify any sections of this license as they pertain to the results of applying that process.
  10. (a) A Derived Work may be distributed under a different license provided that license itself honors the conditions listed in Clause 6 above, in regard to the Work, though it does not have to honor the rest of the conditions in this license.
    - (b) If a Derived Work is distributed under a different license, that Derived Work must provide sufficient documentation as part of itself to allow each recipient of that Derived Work to honor the restrictions in Clause 6 above, concerning changes from the Work.
  11. This license places no restrictions on works that are unrelated to the Work, nor does this license place any restrictions on aggregating such works with the Work by any means.
  12. Nothing in this license is intended to, or may be used to, prevent complete compliance by all parties with all applicable laws.

#### **9.3.4 No Warranty**

There is no warranty for the Work. Except when otherwise stated in writing, the Copyright Holder provides the Work ‘as is’, without warranty of any kind, either expressed or implied, including, but not limited to, the implied warranties of merchantability and fitness for a particular purpose. The entire risk as to the quality and performance of the Work is with you. Should the Work prove defective, you assume the cost of all necessary servicing, repair, or correction.

In no event unless required by applicable law or agreed to in writing will The Copyright Holder, or any author named in the components of the Work, or any other party who may distribute and/or modify the Work as permitted above, be liable to you for damages, including any general, special, incidental or consequential damages arising out of any use of the Work or out of inability to use the Work (including, but not limited to, loss of data, data being rendered inaccurate, or losses sustained by anyone as a result of any failure of the Work to operate with any other programs), even if the Copyright Holder or said author or said other party has been advised of the possibility of such damages.

### 9.3.5 Maintenance of The Work

The Work has the status ‘author-maintained’ if the Copyright Holder explicitly and prominently states near the primary copyright notice in the Work that the Work can only be maintained by the Copyright Holder or simply that it is ‘author-maintained’.

The Work has the status ‘maintained’ if there is a Current Maintainer who has indicated in the Work that they are willing to receive error reports for the Work (for example, by supplying a valid e-mail address). It is not required for the Current Maintainer to acknowledge or act upon these error reports.

The Work changes from status ‘maintained’ to ‘unmaintained’ if there is no Current Maintainer, or the person stated to be Current Maintainer of the work cannot be reached through the indicated means of communication for a period of six months, and there are no other significant signs of active maintenance.

You can become the Current Maintainer of the Work by agreement with any existing Current Maintainer to take over this role.

If the Work is unmaintained, you can become the Current Maintainer of the Work through the following steps:

1. Make a reasonable attempt to trace the Current Maintainer (and the Copyright Holder, if the two differ) through the means of an Internet or similar search.
2. If this search is successful, then enquire whether the Work is still maintained.
  - (a) If it is being maintained, then ask the Current Maintainer to update their communication data within one month.
  - (b) If the search is unsuccessful or no action to resume active maintenance is taken by the Current Maintainer, then announce within the pertinent community your intention to take over maintenance. (If the Work is a  $\text{\LaTeX}$  work, this could be done, for example, by posting to `comp.text.tex`.)
3.
  - (a) If the Current Maintainer is reachable and agrees to pass maintenance of the Work to you, then this takes effect immediately upon announcement.
  - (b) If the Current Maintainer is not reachable and the Copyright Holder agrees that maintenance of the Work be passed to you, then this takes effect immediately upon announcement.
4. If you make an ‘intention announcement’ as described in 2b above and after three months your intention is challenged neither by the Current Maintainer nor by the Copyright Holder nor by other people, then you may arrange for the Work to be changed so as to name you as the (new) Current Maintainer.
5. If the previously unreachable Current Maintainer becomes reachable once more within three months of a change completed under the terms of 3b or 4, then that Current Maintainer must become or remain the Current Maintainer upon request provided they then update their communication data within one month.

A change in the Current Maintainer does not, of itself, alter the fact that the Work is distributed under the LPPL license.

If you become the Current Maintainer of the Work, you should immediately provide, within the Work, a prominent and unambiguous statement of your status as Current Maintainer. You should also announce your new status to the same pertinent community as in 2b above.

### 9.3.6 Whether and How to Distribute Works under This License

This section contains important instructions, examples, and recommendations for authors who are considering distributing their works under this license. These authors are addressed as ‘you’ in this section.

### 9.3.7 Choosing This License or Another License

If for any part of your work you want or need to use *distribution* conditions that differ significantly from those in this license, then do not refer to this license anywhere in your work but, instead, distribute your work under a different license. You may use the text of this license as a model for your own license, but your license should not refer to the LPPL or otherwise give the impression that your work is distributed under the LPPL.

The document ‘`modguide.tex`’ in the base  $\text{\LaTeX}$  distribution explains the motivation behind the conditions of this license. It explains, for example, why distributing  $\text{\LaTeX}$  under the GNU General Public

License (GPL) was considered inappropriate. Even if your work is unrelated to L<sup>A</sup>T<sub>E</sub>X, the discussion in ‘modguide.tex’ may still be relevant, and authors intending to distribute their works under any license are encouraged to read it.

### 9.3.8 A Recommendation on Modification Without Distribution

It is wise never to modify a component of the Work, even for your own personal use, without also meeting the above conditions for distributing the modified component. While you might intend that such modifications will never be distributed, often this will happen by accident – you may forget that you have modified that component; or it may not occur to you when allowing others to access the modified version that you are thus distributing it and violating the conditions of this license in ways that could have legal implications and, worse, cause problems for the community. It is therefore usually in your best interest to keep your copy of the Work identical with the public one. Many works provide ways to control the behavior of that work without altering any of its licensed components.

### 9.3.9 How to Use This License

To use this license, place in each of the components of your work both an explicit copyright notice including your name and the year the work was authored and/or last substantially modified. Include also a statement that the distribution and/or modification of that component is constrained by the conditions in this license.

Here is an example of such a notice and statement:

```
%% pig.dtx
%% Copyright 2005 M. Y. Name
%
% This work may be distributed and/or modified under the
% conditions of the LaTeX Project Public License, either version 1.3
% of this license or (at your option) any later version.
% The latest version of this license is in
% http://www.latex-project.org/lppl.txt
% and version 1.3 or later is part of all distributions of LaTeX
% version 2005/12/01 or later.
%
% This work has the LPPL maintenance status ‘maintained’.
%
% The Current Maintainer of this work is M. Y. Name.
%
% This work consists of the files pig.dtx and pig.ins
% and the derived file pig.sty.
```

Given such a notice and statement in a file, the conditions given in this license document would apply, with the ‘Work’ referring to the three files ‘pig.dtx’, ‘pig.ins’, and ‘pig.sty’ (the last being generated from ‘pig.dtx’ using ‘pig.ins’), the ‘Base Interpreter’ referring to any ‘L<sup>A</sup>T<sub>E</sub>X-Format’, and both ‘Copyright Holder’ and ‘Current Maintainer’ referring to the person ‘M. Y. Name’.

If you do not want the Maintenance section of LPPL to apply to your Work, change ‘maintained’ above into ‘author-maintained’. However, we recommend that you use ‘maintained’ as the Maintenance section was added in order to ensure that your Work remains useful to the community even when you can no longer maintain and support it yourself.

### 9.3.10 Derived Works That Are Not Replacements

Several clauses of the LPPL specify means to provide reliability and stability for the user community. They therefore concern themselves with the case that a Derived Work is intended to be used as a (compatible or incompatible) replacement of the original Work. If this is not the case (e.g., if a few lines of code are reused for a completely different task), then clauses 6b and 6d shall not apply.

### 9.3.11 Important Recommendations

**Defining What Constitutes the Work** The LPPL requires that distributions of the Work contain all the files of the Work. It is therefore important that you provide a way for the licensee to determine which

files constitute the Work. This could, for example, be achieved by explicitly listing all the files of the Work near the copyright notice of each file or by using a line such as:

```
% This work consists of all files listed in manifest.txt.
```

in that place. In the absence of an unequivocal list it might be impossible for the licensee to determine what is considered by you to comprise the Work and, in such a case, the licensee would be entitled to make reasonable conjectures as to which files comprise the Work.

## 9.4 GNU Free Documentation License, Version 1.2, November 2002

### 9.4.1 Preamble

The purpose of this License is to make a manual, textbook, or other functional and useful document “free” in the sense of freedom: to assure everyone the effective freedom to copy and redistribute it, with or without modifying it, either commercially or noncommercially. Secondly, this License preserves for the author and publisher a way to get credit for their work, while not being considered responsible for modifications made by others.

This License is a kind of “copyleft”, which means that derivative works of the document must themselves be free in the same sense. It complements the GNU General Public License, which is a copyleft license designed for free software.

We have designed this License in order to use it for manuals for free software, because free software needs free documentation: a free program should come with manuals providing the same freedoms that the software does. But this License is not limited to software manuals; it can be used for any textual work, regardless of subject matter or whether it is published as a printed book. We recommend this License principally for works whose purpose is instruction or reference.

### 9.4.2 Applicability and definitions

This License applies to any manual or other work, in any medium, that contains a notice placed by the copyright holder saying it can be distributed under the terms of this License. Such a notice grants a world-wide, royalty-free license, unlimited in duration, to use that work under the conditions stated herein. The “**Document**”, below, refers to any such manual or work. Any member of the public is a licensee, and is addressed as “**you**”. You accept the license if you copy, modify or distribute the work in a way requiring permission under copyright law.

A “**Modified Version**” of the Document means any work containing the Document or a portion of it, either copied verbatim, or with modifications and/or translated into another language.

A “**Secondary Section**” is a named appendix or a front-matter section of the Document that deals exclusively with the relationship of the publishers or authors of the Document to the Document’s overall subject (or to related matters) and contains nothing that could fall directly within that overall subject. (Thus, if the Document is in part a textbook of mathematics, a Secondary Section may not explain any mathematics.) The relationship could be a matter of historical connection with the subject or with related matters, or of legal, commercial, philosophical, ethical or political position regarding them.

The “**Invariant Sections**” are certain Secondary Sections whose titles are designated, as being those of Invariant Sections, in the notice that says that the Document is released under this License. If a section does not fit the above definition of Secondary then it is not allowed to be designated as Invariant. The Document may contain zero Invariant Sections. If the Document does not identify any Invariant Sections then there are none.

The “**Cover Texts**” are certain short passages of text that are listed, as Front-Cover Texts or Back-Cover Texts, in the notice that says that the Document is released under this License. A Front-Cover Text may be at most 5 words, and a Back-Cover Text may be at most 25 words.

A “**Transparent**” copy of the Document means a machine-readable copy, represented in a format whose specification is available to the general public, that is suitable for revising the document straightforwardly with generic text editors or (for images composed of pixels) generic paint programs or (for drawings) some widely available drawing editor, and that is suitable for input to text formatters or for automatic translation to a variety of formats suitable for input to text formatters. A copy made in an otherwise Transparent file format whose markup, or absence of markup, has been arranged to thwart or discourage subsequent modification by readers is not Transparent. An image format is not Transparent if used for any substantial amount of text. A copy that is not “Transparent” is called “**Opaque**”.

Examples of suitable formats for Transparent copies include plain ASCII without markup, Texinfo input format, LaTeX input format, SGML or XML using a publicly available DTD, and standard-conforming simple HTML, PostScript or PDF designed for human modification. Examples of transparent image formats include PNG, XCF and JPG. Opaque formats include proprietary formats that can be read and edited only by proprietary word processors, SGML or XML for which the DTD and/or processing tools are not generally available, and the machine-generated HTML, PostScript or PDF produced by some word processors for output purposes only.

The “**Title Page**” means, for a printed book, the title page itself, plus such following pages as are needed to hold, legibly, the material this License requires to appear in the title page. For works in formats which do not have any title page as such, “Title Page” means the text near the most prominent appearance of the work’s title, preceding the beginning of the body of the text.

A section “**Entitled XYZ**” means a named subunit of the Document whose title either is precisely XYZ or contains XYZ in parentheses following text that translates XYZ in another language. (Here XYZ stands for a specific section name mentioned below, such as “**Acknowledgements**”, “**Dedications**”, “**Endorsements**”, or “**History**”.) To “**Preserve the Title**” of such a section when you modify the Document means that it remains a section “Entitled XYZ” according to this definition.

The Document may include Warranty Disclaimers next to the notice which states that this License applies to the Document. These Warranty Disclaimers are considered to be included by reference in this License, but only as regards disclaiming warranties: any other implication that these Warranty Disclaimers may have is void and has no effect on the meaning of this License.

#### 9.4.3 Verbatim Copying

You may copy and distribute the Document in any medium, either commercially or noncommercially, provided that this License, the copyright notices, and the license notice saying this License applies to the Document are reproduced in all copies, and that you add no other conditions whatsoever to those of this License. You may not use technical measures to obstruct or control the reading or further copying of the copies you make or distribute. However, you may accept compensation in exchange for copies. If you distribute a large enough number of copies you must also follow the conditions in section 3.

You may also lend copies, under the same conditions stated above, and you may publicly display copies.

#### 9.4.4 Copying in Quantity

If you publish printed copies (or copies in media that commonly have printed covers) of the Document, numbering more than 100, and the Document’s license notice requires Cover Texts, you must enclose the copies in covers that carry, clearly and legibly, all these Cover Texts: Front-Cover Texts on the front cover, and Back-Cover Texts on the back cover. Both covers must also clearly and legibly identify you as the publisher of these copies. The front cover must present the full title with all words of the title equally prominent and visible. You may add other material on the covers in addition. Copying with changes limited to the covers, as long as they preserve the title of the Document and satisfy these conditions, can be treated as verbatim copying in other respects.

If the required texts for either cover are too voluminous to fit legibly, you should put the first ones listed (as many as fit reasonably) on the actual cover, and continue the rest onto adjacent pages.

If you publish or distribute Opaque copies of the Document numbering more than 100, you must either include a machine-readable Transparent copy along with each Opaque copy, or state in or with each Opaque copy a computer-network location from which the general network-using public has access to download using public-standard network protocols a complete Transparent copy of the Document, free of added material. If you use the latter option, you must take reasonably prudent steps, when you begin distribution of Opaque copies in quantity, to ensure that this Transparent copy will remain thus accessible at the stated location until at least one year after the last time you distribute an Opaque copy (directly or through your agents or retailers) of that edition to the public.

It is requested, but not required, that you contact the authors of the Document well before redistributing any large number of copies, to give them a chance to provide you with an updated version of the Document.

#### 9.4.5 Modifications

You may copy and distribute a Modified Version of the Document under the conditions of sections 2 and 3 above, provided that you release the Modified Version under precisely this License, with the Modified

Version filling the role of the Document, thus licensing distribution and modification of the Modified Version to whoever possesses a copy of it. In addition, you must do these things in the Modified Version:

- A. Use in the Title Page (and on the covers, if any) a title distinct from that of the Document, and from those of previous versions (which should, if there were any, be listed in the History section of the Document). You may use the same title as a previous version if the original publisher of that version gives permission.
- B. List on the Title Page, as authors, one or more persons or entities responsible for authorship of the modifications in the Modified Version, together with at least five of the principal authors of the Document (all of its principal authors, if it has fewer than five), unless they release you from this requirement.
- C. State on the Title page the name of the publisher of the Modified Version, as the publisher.
- D. Preserve all the copyright notices of the Document.
- E. Add an appropriate copyright notice for your modifications adjacent to the other copyright notices.
- F. Include, immediately after the copyright notices, a license notice giving the public permission to use the Modified Version under the terms of this License, in the form shown in the Addendum below.
- G. Preserve in that license notice the full lists of Invariant Sections and required Cover Texts given in the Document's license notice.
- H. Include an unaltered copy of this License.
- I. Preserve the section Entitled "History", Preserve its Title, and add to it an item stating at least the title, year, new authors, and publisher of the Modified Version as given on the Title Page. If there is no section Entitled "History" in the Document, create one stating the title, year, authors, and publisher of the Document as given on its Title Page, then add an item describing the Modified Version as stated in the previous sentence.
- J. Preserve the network location, if any, given in the Document for public access to a Transparent copy of the Document, and likewise the network locations given in the Document for previous versions it was based on. These may be placed in the "History" section. You may omit a network location for a work that was published at least four years before the Document itself, or if the original publisher of the version it refers to gives permission.
- K. For any section Entitled "Acknowledgements" or "Dedications", Preserve the Title of the section, and preserve in the section all the substance and tone of each of the contributor acknowledgements and/or dedications given therein.
- L. Preserve all the Invariant Sections of the Document, unaltered in their text and in their titles. Section numbers or the equivalent are not considered part of the section titles.
- M. Delete any section Entitled "Endorsements". Such a section may not be included in the Modified Version.
- N. Do not retitle any existing section to be Entitled "Endorsements" or to conflict in title with any Invariant Section.
- O. Preserve any Warranty Disclaimers.

If the Modified Version includes new front-matter sections or appendices that qualify as Secondary Sections and contain no material copied from the Document, you may at your option designate some or all of these sections as invariant. To do this, add their titles to the list of Invariant Sections in the Modified Version's license notice. These titles must be distinct from any other section titles.

You may add a section Entitled "Endorsements", provided it contains nothing but endorsements of your Modified Version by various parties—for example, statements of peer review or that the text has been approved by an organization as the authoritative definition of a standard.

You may add a passage of up to five words as a Front-Cover Text, and a passage of up to 25 words as a Back-Cover Text, to the end of the list of Cover Texts in the Modified Version. Only one passage of Front-Cover Text and one of Back-Cover Text may be added by (or through arrangements made by) any

one entity. If the Document already includes a cover text for the same cover, previously added by you or by arrangement made by the same entity you are acting on behalf of, you may not add another; but you may replace the old one, on explicit permission from the previous publisher that added the old one.

The author(s) and publisher(s) of the Document do not by this License give permission to use their names for publicity for or to assert or imply endorsement of any Modified Version.

#### **9.4.6 Combining Documents**

You may combine the Document with other documents released under this License, under the terms defined in section 4 above for modified versions, provided that you include in the combination all of the Invariant Sections of all of the original documents, unmodified, and list them all as Invariant Sections of your combined work in its license notice, and that you preserve all their Warranty Disclaimers.

The combined work need only contain one copy of this License, and multiple identical Invariant Sections may be replaced with a single copy. If there are multiple Invariant Sections with the same name but different contents, make the title of each such section unique by adding at the end of it, in parentheses, the name of the original author or publisher of that section if known, or else a unique number. Make the same adjustment to the section titles in the list of Invariant Sections in the license notice of the combined work.

In the combination, you must combine any sections Entitled “History” in the various original documents, forming one section Entitled “History”; likewise combine any sections Entitled “Acknowledgements”, and any sections Entitled “Dedications”. You must delete all sections Entitled “Endorsements”.

#### **9.4.7 Collection of Documents**

You may make a collection consisting of the Document and other documents released under this License, and replace the individual copies of this License in the various documents with a single copy that is included in the collection, provided that you follow the rules of this License for verbatim copying of each of the documents in all other respects.

You may extract a single document from such a collection, and distribute it individually under this License, provided you insert a copy of this License into the extracted document, and follow this License in all other respects regarding verbatim copying of that document.

#### **9.4.8 Aggregating with independent Works**

A compilation of the Document or its derivatives with other separate and independent documents or works, in or on a volume of a storage or distribution medium, is called an “aggregate” if the copyright resulting from the compilation is not used to limit the legal rights of the compilation’s users beyond what the individual works permit. When the Document is included in an aggregate, this License does not apply to the other works in the aggregate which are not themselves derivative works of the Document.

If the Cover Text requirement of section 3 is applicable to these copies of the Document, then if the Document is less than one half of the entire aggregate, the Document’s Cover Texts may be placed on covers that bracket the Document within the aggregate, or the electronic equivalent of covers if the Document is in electronic form. Otherwise they must appear on printed covers that bracket the whole aggregate.

#### **9.4.9 Translation**

Translation is considered a kind of modification, so you may distribute translations of the Document under the terms of section 4. Replacing Invariant Sections with translations requires special permission from their copyright holders, but you may include translations of some or all Invariant Sections in addition to the original versions of these Invariant Sections. You may include a translation of this License, and all the license notices in the Document, and any Warranty Disclaimers, provided that you also include the original English version of this License and the original versions of those notices and disclaimers. In case of a disagreement between the translation and the original version of this License or a notice or disclaimer, the original version will prevail.

If a section in the Document is Entitled “Acknowledgements”, “Dedications”, or “History”, the requirement (section 4) to Preserve its Title (section 1) will typically require changing the actual title.

#### **9.4.10 Termination**

You may not copy, modify, sublicense, or distribute the Document except as expressly provided for under this License. Any other attempt to copy, modify, sublicense or distribute the Document is void, and will



automatically terminate your rights under this License. However, parties who have received copies, or rights, from you under this License will not have their licenses terminated so long as such parties remain in full compliance.

#### **9.4.11 Future Revisions of this License**

The Free Software Foundation may publish new, revised versions of the GNU Free Documentation License from time to time. Such new versions will be similar in spirit to the present version, but may differ in detail to address new problems or concerns. See <http://www.gnu.org/copyleft/>.

Each version of the License is given a distinguishing version number. If the Document specifies that a particular numbered version of this License “or any later version” applies to it, you have the option of following the terms and conditions either of that specified version or of any later version that has been published (not as a draft) by the Free Software Foundation. If the Document does not specify a version number of this License, you may choose any version ever published (not as a draft) by the Free Software Foundation.

#### **9.4.12 Addendum: How to use this License for your documents**

To use this License in a document you have written, include a copy of the License in the document and put the following copyright and license notices just after the title page:

Copyright ©YEAR YOUR NAME. Permission is granted to copy, distribute and/or modify this document under the terms of the GNU Free Documentation License, Version 1.2 or any later version published by the Free Software Foundation; with no Invariant Sections, no Front-Cover Texts, and no Back-Cover Texts. A copy of the license is included in the section entitled “GNU Free Documentation License”.

If you have Invariant Sections, Front-Cover Texts and Back-Cover Texts, replace the “with . . . Texts.” line with this:

with the Invariant Sections being LIST THEIR TITLES, with the Front-Cover Texts being LIST, and with the Back-Cover Texts being LIST.

If you have Invariant Sections without Cover Texts, or some other combination of the three, merge those two alternatives to suit the situation.

If your document contains nontrivial examples of program code, we recommend releasing these examples in parallel under your choice of free software license, such as the GNU General Public License, to permit their use in free software.

## 10 Input and Output Formats

$\TeX$  was designed to be a flexible system. This is true both for the *input* for  $\TeX$  as well as for the *output*. The present section explains which input formats there are and how they are supported by PGF. It also explains which different output formats can be produced.

### 10.1 Supported Input Formats

$\TeX$  does not prescribe exactly how your input should be formatted. While it is *customary* that, say, an opening brace starts a scope in  $\TeX$ , this is by no means necessary. Likewise, it is *customary* that environments start with `\begin`, but  $\TeX$  could not really care less about the exact command name.

Even though  $\TeX$  can be reconfigured, users can not. For this reason, certain *input formats* specify a set of commands and conventions how input for  $\TeX$  should be formatted. There are currently three “major” formats: Donald Knuth’s original plain  $\TeX$  format, Leslie Lamport’s popular  $\LaTeX$  format, and Hans Hangen’s Con $\TeX$ t format.

#### 10.1.1 Using the $\LaTeX$ Format

Using PGF and TikZ with the  $\LaTeX$  format is easy: You say `\usepackage{pgf}` or `\usepackage{tikz}`. Usually, that is all you need to do, all configuration will be done automatically and (hopefully) correctly.

The style files used for the  $\LaTeX$  format reside in the subdirectory `latex/pgf/` of the PGF-system. Mainly, what these files do is to include files in the directory `generic/pgf`. For example, here is the content of the file `latex/pgf/frontends/tikz.sty`:

```
% Copyright 2006 by Till Tantau
%
% This file may be distributed and/or modified
%
% 1. under the LaTeX Project Public License and/or
% 2. under the GNU Public License.
%
% See the file doc/generic/pgf/licenses/LICENSE for more details.

\RequirePackage{pgf,pgffor}

\input{tikz.code.tex}

\endinput
```

The files in the `generic/pgf` directory do the actual work.

#### 10.1.2 Using the Plain $\TeX$ Format

When using the plain  $\TeX$  format, you say `\input{pgf.tex}` or `\input{tikz.tex}`. Then, instead of `\begin{pgfpicture}` and `\end{pgfpicture}` you use `\pgfpicture` and `\endpgfpicture`.

Unlike for the  $\LaTeX$  format, PGF is not as good at discerning the appropriate configuration for the plain  $\TeX$  format. In particular, it can only automatically determine the correct output format if you use `pdftex` or `tex` plus `dvips`. For all other output formats you need to set the macro `\pgfsysdriver` to the correct value. See the description of using output formats later on.

PGF was originally written for use with  $\LaTeX$  and this shows in a number of places. Nevertheless, the plain  $\TeX$  support is reasonably good.

Like the  $\LaTeX$  style files, the plain  $\TeX$  files like `tikz.tex` also just include the correct `tikz.code.tex` file.

#### 10.1.3 Using the Con $\TeX$ t Format

When using the Con $\TeX$ t format, you say `\usemodule[pgf]` or `\usemodule[tikz]`. As for the plain  $\TeX$  format you also have to replace the start- and end-of-environment tags as follows: Instead of `\begin{pgfpicture}` and `\end{pgfpicture}` you use `\startpgfpicture` and `\stoppgfpicture`; similarly, instead of `\begin{tikzpicture}` and `\end{tikzpicture}` you use must now use `\starttikzpicture` and `\stoptikzpicture`; and so on for other environments.

The Con $\TeX$ t support is very similar to the plain  $\TeX$  support, so the same restrictions apply: You may have to set the output format directly and graphics inclusion may be a problem.

In addition to `pgf` and `tikz` there also exist modules like `pgfcore` or `pgfmodulematrix`. To use them, you may need to include the module `pgfmod` first (the modules `pgf` and `tikz` both include `pgfmod` for you, so typically you can skip this). This special module is necessary since ConTeXt satanically restricts the length of module names to 6 characters and PGF’s long names are mapped to cryptic 6-letter-names for you by the module `pgfmod`.

## 10.2 Supported Output Formats

An output format is a format in which TeX outputs the text it has typeset. Producing the output is (conceptually) a two-stage process:

1. TeX typesets your text and graphics. The result of this typesetting is mainly a long list of letter-coordinate pairs, plus (possibly) some “special” commands. This long list of pairs is written to something called a `.dvi`-file.
2. Some other program reads this `.dvi`-file and translates the letter-coordinate pairs into, say, PostScript commands for placing the given letter at the given coordinate.

The classical example of this process is the combination of `latex` and `dvips`. The `latex` program (which is just the `tex` program called with the L<sup>A</sup>TeX-macros preinstalled) produces a `.dvi`-file as its output. The `dvips` program takes this output and produces a `.ps`-file (a PostScript) file. Possibly, this file is further converted using, say, `ps2pdf`, whose name is supposed to mean “PostScript to PDF.” Another example of programs using this process is the combination of `tex` and `dvipdfm`. The `dvipdfm` program takes a `.dvi`-file as input and translates the letter-coordinate pairs therein into PDF-commands, resulting in a `.pdf` file directly. Finally, the `tex4ht` is also a program that takes a `.dvi`-file and produces an output, this time it is a `.html` file. The programs `pdftex` and `pdflatex` are special: They directly produce a `.pdf`-file without the intermediate `.dvi`-stage. However, from the programmer’s point of view they behave exactly as if there were an intermediate stage.

Normally, TeX only produces letter-coordinate pairs as its “output.” This obviously makes it difficult to draw, say, a curve. For this, “special” commands can be used. Unfortunately, these special commands are not the same for the different programs that process the `.dvi`-file. Indeed, every program that takes a `.dvi`-file as input has a totally different syntax for the special commands.

One of the main jobs of PGF is to “abstract away” the difference in the syntax of the different programs. However, this means that support for each program has to be “programmed,” which is a time-consuming and complicated process.

### 10.2.1 Selecting the Backend Driver

When TeX typesets your document, it does not know which program you are going to use to transform the `.dvi`-file. If your `.dvi`-file does not contain any special commands, this would be fine; but these days almost all `.dvi`-files contain lots of special commands. It is thus necessary to tell TeX which program you are going to use later on.

Unfortunately, there is no “standard” way of telling this to TeX. For the L<sup>A</sup>TeX format a sophisticated mechanism exists inside the `graphics` package and PGF plugs into this mechanism. For other formats and when this plugging does not work as expected, it is necessary to tell PGF directly which program you are going to use. This is done by redefining the macro `\pgfsysdriver` to an appropriate value *before* you load `pgf`. If you are going to use the `dvips` program, you set this macro to the value `pgfsys-dvips.def`; if you use `pdftex` or `pdflatex`, you set it to `pgfsys-pdftex.def`; and so on. In the following, details of the support of the different programs are discussed.

### 10.2.2 Producing PDF Output

PGF supports three programs that produce PDF output (PDF means “portable document format” and was invented by the Adobe company): `dvipdfm`, `pdftex`, and `vtex`. The `pdflatex` program is the same as the `pdftex` program: it uses a different input format, but the output is exactly the same.

#### File `pgfsys-pdftex.def`

This is the driver file for use with pdfTeX, that is, with the `pdftex` or `pdflatex` command. It includes `pgfsys-common-pdf.def`.

This driver has the “complete” functionality. This means, everything PGF “can do at all” is implemented in this driver.

File `pgfsys-dvipdfm.def`

This is a driver file for use with `(la)tex` followed by `dvipdfm`. It includes `pgfsys-common-pdf.def`. This driver supports most of PGF's features, but there are some restrictions:

1. In  $\LaTeX$  mode it uses `graphicx` for the graphics inclusion and does not support masking.
2. In plain  $\TeX$  mode it does not support image inclusion.
3. For remembering of pictures (inter-picture connections) you need to use a recent version of `pdftex` running in DVI-mode.
4. Patterns are not (cannot) be supported.
5. Functional shadings are not (cannot) be supported.

File `pgfsys-xetex.def`

This is a driver file for use with `xe(la)tex` followed by `xdvipdfmx`. This driver supports the same operations as the `dvipdfm` driver, except that remembering of pictures (inter-picture connections) always works.

File `pgfsys-vtex.def`

This is the driver file for use with the commercial `VTEX` program. Even though it produces PDF output, it includes `pgfsys-common-postscript.def`. Note that the `VTEX` program can produce *both* Postscript and PDF output, depending on the command line parameters. However, whether you produce Postscript or PDF output does not change anything with respect to the driver.

This driver supports most of PGF's features, except for the following restrictions:

1. In  $\LaTeX$  mode it uses `graphicx` for the graphics inclusion and does not support masking.
2. In plain  $\TeX$  mode it does not support image inclusion.
3. Shading is fully implemented, but yields the same quality as the implementation for `dvips`.
4. Opacity is not supported.
5. Remembering of pictures (inter-picture connections) is not supported.

It is also possible to produce a `.pdf`-file by first producing a PostScript file (see below) and then using a PostScript-to-PDF conversion program like `ps2pdf` or the Acrobat Distiller.

### 10.2.3 Producing PostScript Output

File `pgfsys-dvips.def`

This is a driver file for use with `(la)tex` followed by `dvips`. It includes `pgfsys-common-postscript.def`. This driver also supports most of PGF's features, except for the following restrictions:

1. In  $\LaTeX$  mode it uses `graphicx` for the graphics inclusion and does not support masking.
2. In plain  $\TeX$  mode it does not support image inclusion.
3. Shading is fully implemented, but the results will not be as good as with a driver producing `.pdf` as output.
4. Opacity works only in conjunction with newer versions of GhostScript.
5. For remembering of pictures (inter-picture connections) you need to use a recent version of `pdftex` running in DVI-mode.

File `pgfsys-textures.def`

This is a driver file for use with the `TEXTURES` program. It includes `pgfsys-common-postscript.def`. This driver has exactly the same restrictions as the driver for `dvips`.

You can also use the `vtex` program together with `pgfsys-vtex.def` to produce Postscript output.

## 10.2.4 Producing HTML / SVG Output

The `tex4ht` program converts `.dvi`-files to `.html`-files. While the HTML-format cannot be used to draw graphics, the SVG-format can. Using the following driver, you can ask PGF to produce an SVG-picture for each PGF graphic in your text.

File `pgfsys-tex4ht.def`

This is a driver file for use with the `tex4ht` program. It includes `pgfsys-common-svg.def`.

When using this driver you should be aware of the following restrictions:

1. In L<sup>A</sup>T<sub>E</sub>X mode it uses `graphicx` for the graphics inclusion.
2. In plain T<sub>E</sub>X mode it does not support image inclusion.
3. Remembering of pictures (inter-picture connections) is not supported.
4. Text inside `pgfpictures` is not supported very well. The reason is that the SVG specification currently does not support text very well and, although it is possible to “escape back” to HTML, `Tikz` has then to guess what size the text rendered by the browser would have.
5. Unlike for other output formats, the bounding box of a picture “really crops” the picture.
6. Matrices do not work.
7. Functional shadings are not supported.

The driver basically works as follows: When a `{pgfpicture}` is started, appropriate `\special` commands are used to direct the output of `tex4ht` to a new file called `\jobname-xxx.svg`, where `xxx` is a number that is increased for each graphic. Then, till the end of the picture, each (system layer) graphic command creates a special that inserts appropriate SVG literal text into the output file. The exact details are a bit complicated since the imaging model and the processing model of PostScript/PDF and SVG are not quite the same; but they are “close enough” for PGF’s purposes.

Because text is not supported very well in the SVG standard, you may wish to use the following options to modify the way text is handled:

`/tikz/tex4ht node/escape=<boolean>` (default **false**)

Selects the rendering method for a text node with the `tex4ht` driver.

When this key is set to **false**, text is translated into SVG text, which is somewhat limited: simple characters (letters, numerals, punctuation,  $\sum$ ,  $\int$ , ...), subscripts and superscripts (but not subsubscripts) will display but everything else will be filtered out, ignored or will produce invalid HTML code (in the worst case). This means that two kind of texts render reasonably well:

1. First, plain text without math mode, special characters or anything else special.
2. Second, *very* simple mathematical text that contains subscripts or superscripts. Even then, variables are not correctly set in italics and, in general, text simple does not look very nice.

If you use text that contains anything special, even something as simple as  $\alpha$ , this may corrupt the graphic.

```
\tikz \node[draw,tex4ht node/escape=false] {Example :  $(a+b)^2=a^2+2ab+b^2$ };
```

When you write `node[tex4ht node/escape=true] {<text>}`, `TikZ` escapes back to HTML to render the `<text>`. This method produces valid HTML code in most cases and the support for complicated text nodes is much better since code that renders well outside a `{tikzpicture}`, should also render well inside a text node. Another advantage is that inside text nodes with fixed width, HTML will produce line breaks for long lines. On the other hand, you need a browser with good SVG support to display the picture. Also, the text will display differently, depending on your browsers, the fonts you have on your system and your settings. Finally, `TikZ` has to guess the size of the text rendered by the browser to scale it and prevent it from sticking from the node. When it fails, the text will be either cropped or too small.

```
\tikz \node[draw,tex4ht node/escape=true]
{Example :  $\int_0^{\infty} \frac{1}{1+t^2} dt = \frac{\pi}{2}$ };
```

`/tikz/tex4ht node/css=<filename>` (default `\jobname`)

This option allows you to tell the browser what CSS file it should use to style the display of the node (only with `tex4ht node/escape=true`).

`/tikz/tex4ht node/class=<class name>` (default `foreignobject`)

This option allows you to give a class name to the node, allowing it to be styled by a CSS file (only with `tex4ht node/escape=true`).

`/tikz/tex4ht node/id=<id name>` (default `\jobname picture number-node number`)

This option allows you to give a unique id to the node, allowing it to be styled by a CSS file (only with `tex4ht node/escape=true`).

## 10.2.5 Producing Perfectly Portable DVI Output

File `pgfsys-dvi.def`

This is a driver file that can be used with any output driver, except for `tex4ht`.

The driver will produce perfectly portable `.dvi` files by composing all pictures entirely of black rectangles, the basic and only graphic shape supported by the  $\TeX$  core. Even straight, but slanted lines are tricky to get right in this model (they need to be composed of lots of little squares).

Naturally, *very little* is possible with this driver. In fact, so little is possible that it is easier to list what is possible:

- Text boxes can be placed in the normal way.
- Lines and curves can be drawn (stroked). If they are not horizontal or vertical, they are composed of hundred of small rectangles.
- Lines of different width are supported.
- Transformations are supported.

Note that, say, even filling is not supported! (Let alone color or anything fancy.)

This driver has only one real application: It might be useful when you only need horizontal or vertical lines in a picture. Then, the results are quite satisfactory.

## Part III

# TikZ ist *kein* Zeichenprogramm

by Till Tantau

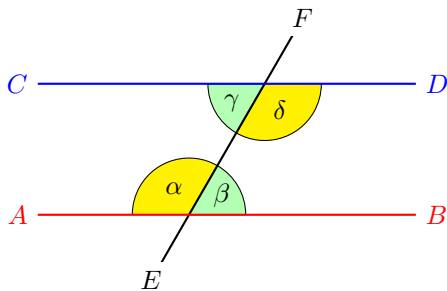

When we assume that  $AB$  and  $CD$  are parallel, i. e.,  $AB \parallel CD$ , then  $\alpha = \delta$  and  $\beta = \gamma$ .

```
\begin{tikzpicture}
  \draw[fill=yellow] (0,0) -- (60:.75cm) arc (60:180:.75cm);
  \draw(120:0.4cm) node {$\alpha$};

  \draw[fill=green!30] (0,0) -- (right:.75cm) arc (0:60:.75cm);
  \draw(30:0.5cm) node {$\beta$};

  \begin{scope}[shift={(60:2cm)}]
    \draw[fill=green!30] (0,0) -- (180:.75cm) arc (180:240:.75cm);
    \draw (30:-0.5cm) node {$\gamma$};

    \draw[fill=yellow] (0,0) -- (240:.75cm) arc (240:360:.75cm);
    \draw (-60:0.4cm) node {$\delta$};
  \end{scope}

  \begin{scope}[thick]
    \draw (60:-1cm) node[fill=white] {$E$} -- (60:3cm) node[fill=white] {$F$};
    \draw[red] (-2,0) node[left] {$A$} -- (3,0) node[right]{$B$};
    \draw[blue,shift={(60:2cm)}] (-3,0) node[left] {$C$} -- (2,0) node[right]{$D$};

    \draw[shift={(60:1cm)},xshift=4cm]
    node [right,text width=6cm,rounded corners,fill=red!20,inner sep=1ex]
    {
      When we assume that  $\color{red}AB$  and  $\color{blue}CD$  are
      parallel, i.\,e.,  $\color{red}AB \parallel \color{blue}CD$ ,
      then  $\alpha = \delta$  and  $\beta = \gamma$ .
    };
  \end{scope}
\end{tikzpicture}
```

## 11 Design Principles

This section describes the design principles behind the TikZ frontend, where TikZ means “TikZ ist *kein* Zeichenprogramm.” To use TikZ, as a L<sup>A</sup>T<sub>E</sub>X user say `\usepackage{tikz}` somewhere in the preamble, as a plain T<sub>E</sub>X user say `\input tikz.tex`. TikZ’s job is to make your life easier by providing an easy-to-learn and easy-to-use syntax for describing graphics.

The commands and syntax of TikZ were influenced by several sources. The basic command names and the notion of path operations is taken from METAFONT, the option mechanism comes from PSTricks, the notion of styles is reminiscent of SVG. To make it all work together, some compromises were necessary. I also added some ideas of my own, like coordinate transformations.

The following basic design principles underlie TikZ:

1. Special syntax for specifying points.
2. Special syntax for path specifications.
3. Actions on paths.
4. Key-value syntax for graphic parameters.
5. Special syntax for nodes.
6. Special syntax for trees.
7. Grouping of graphic parameters.
8. Coordinate transformation system.

### 11.1 Special Syntax For Specifying Points

TikZ provides a special syntax for specifying points and coordinates. In the simplest case, you provide two T<sub>E</sub>X dimensions, separated by commas, in round brackets as in `(1cm,2pt)`.

You can also specify a point in polar coordinates by using a colon instead of a comma as in `(30:1cm)`, which means “1cm in a 30 degrees direction.”

If you do not provide a unit, as in `(2,1)`, you specify a point in PGF’s *xy*-coordinate system. By default, the unit *x*-vector goes 1cm to the right and the unit *y*-vector goes 1cm upward.

By specifying three numbers as in `(1,1,1)` you specify a point in PGF’s *xyz*-coordinate system.

It is also possible to use an anchor of a previously defined shape as in `(first node.south)`.

You can add two plus signs before a coordinate as in `++(1cm,0pt)`. This means “1cm to the right of the last point used.” This allows you to easily specify relative movements. For example, `(1,0) ++(1,0) ++(0,1)` specifies the three coordinates `(1,0)`, then `(2,0)`, and `(2,1)`.

Finally, instead of two plus signs, you can also add a single one. This also specifies a point in a relative manner, but it does not “change” the current point used in subsequent relative commands. For example, `(1,0) +(1,0) +(0,1)` specifies the three coordinates `(1,0)`, then `(2,0)`, and `(1,1)`.

### 11.2 Special Syntax For Path Specifications

When creating a picture using TikZ, your main job is the specification of *paths*. A path is a series of straight or curved lines, which need not be connected. TikZ makes it easy to specify paths, partly using the syntax of METAPOST. For example, to specify a triangular path you use

```
(5pt,0pt) -- (0pt,0pt) -- (0pt,5pt) -- cycle
```

and you get when you draw this path.

### 11.3 Actions on Paths

A path is just a series of straight and curved lines, but it is not yet specified what should happen with it. One can *draw* a path, *fill* a path, *shade* it, *clip* it, or do any combination of these. Drawing (also known as *stroking*) can be thought of as taking a pen of a certain thickness and moving it along the path, thereby drawing on the canvas. Filling means that the interior of the path is filled with a uniform color. Obviously, filling makes sense only for *closed* paths and a path is automatically closed prior to filling, if necessary.



Given a path as in `\path (0,0) rectangle (2ex,1ex);`, you can draw it by adding the `draw` option as in `\path[draw] (0,0) rectangle (2ex,1ex);`, which yields  $\square$ . The `\draw` command is just an abbreviation for `\path[draw]`. To fill a path, use the `fill` option or the `\fill` command, which is an abbreviation for `\path[fill]`. The `\filldraw` command is an abbreviation for `\path[fill,draw]`. Shading is caused by the `shade` option (there are `\shade` and `\shadedraw` abbreviations) and clipping by the `clip` option. There is also a `\clip` command, which does the same as `\path[clip]`, but not commands like `\drawclip`. Use, say, `\draw[clip]` or `\path[draw,clip]` instead.

All of these commands can only be used inside `{tikzpicture}` environments.

TikZ allows you to use different colors for filling and stroking.

## 11.4 Key-Value Syntax for Graphic Parameters

Whenever TikZ draws or fills a path, a large number of graphic parameters influenced the rendering. Examples include the colors used, the dashing pattern, the clipping area, the line width, and many others. In TikZ, all these options are specified as lists of so called key-value pairs, as in `color=red`, that are passed as optional parameters to the path drawing and filling commands. This usage is similar to PSTricks. For example, the following will draw a thick, red triangle;

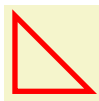

```
\tikz \draw[line width=2pt,color=red] (1,0) -- (0,0) -- (0,1) -- cycle;
```

## 11.5 Special Syntax for Specifying Nodes

TikZ introduces a special syntax for adding text or, more generally, nodes to a graphic. When you specify a path, add nodes as in the following example:

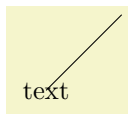

```
\tikz \draw (1,1) node {text} -- (2,2);
```

Nodes are inserted at the current position of the path, but only *after* the path has been rendered. When special options are given, as in `\draw (1,1) node[circle,draw] {text};`, the text is not just put at the current position. Rather, it is surrounded by a circle and this circle is “drawn.”

You can add a name to a node for later reference either by using the option `name=<node name>` or by stating the node name in parentheses outside the text as in `node[circle](name){text}`.

Predefined shapes include `rectangle`, `circle`, and `ellipse`, but it is possible (though a bit challenging) to define new shapes.

## 11.6 Special Syntax for Specifying Trees

In addition to the “node syntax,” TikZ also introduces a special syntax for drawing trees. The syntax is intergrated with the special node syntax and only few new commands need to be remembered. In essence, a `node` can be followed by any number of children, each introduced by the keyword `child`. The children are nodes themselves, each of which may have children in turn.

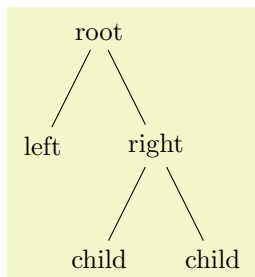

```
\begin{tikzpicture}
  \node {root}
    child {node {left}}
    child {node {right}}
      child {node {child}}
      child {node {child}}
};
\end{tikzpicture}
```

Since trees are made up from nodes, it is possible to use options to modify the way trees are drawn. Here are two examples of the above tree, redrawn with different options:

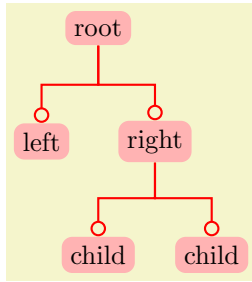

```
\begin{tikzpicture}
[edge from parent fork down,
every node/.style={fill=red!30,rounded corners},
edge from parent/.style={red,-o,thick,draw}]
\node {root}
  child {node {left}}
  child {node {right}}
    child {node {child}}
    child {node {child}}
};
\end{tikzpicture}
```

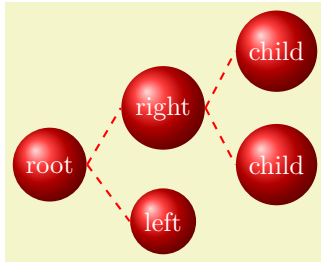

```
\begin{tikzpicture}
[parent anchor=east,child anchor=west,grow=east,
every node/.style={ball color=red,circle,text=white},
edge from parent/.style={draw,dashed,thick,red}]
\node {root}
  child {node {left}}
  child {node {right}}
    child {node {child}}
    child {node {child}}
};
\end{tikzpicture}
```

## 11.7 Grouping of Graphic Parameters

Graphic parameters should often apply to several path drawing or filling commands. For example, we may wish to draw numerous lines all with the same line width of 1pt. For this, we put these commands in a `{scope}` environment that takes the desired graphic options as an optional parameter. Naturally, the specified graphic parameters apply only to the drawing and filling commands inside the environment. Furthermore, nested `{scope}` environments or individual drawing commands can override the graphic parameters of outer `{scope}` environments. In the following example, three red lines, two green lines, and one blue line are drawn:



```
\begin{tikzpicture}
\begin{scope}[color=red]
\draw (0mm,10mm) -- (10mm,10mm);
\draw (0mm, 8mm) -- (10mm, 8mm);
\draw (0mm, 6mm) -- (10mm, 6mm);
\end{scope}
\begin{scope}[color=green]
\draw (0mm, 4mm) -- (10mm, 4mm);
\draw (0mm, 2mm) -- (10mm, 2mm);
\draw[color=blue] (0mm, 0mm) -- (10mm, 0mm);
\end{scope}
\end{tikzpicture}
```

The `{tikzpicture}` environment itself also behaves like a `{scope}` environment, that is, you can specify graphic parameters using an optional argument. These optional apply to all commands in the picture.

## 11.8 Coordinate Transformation System

TikZ supports both PGF's *coordinate* transformation system to perform transformations as well as *canvas* transformations, a more low-level transformation system. (For details on the difference between coordinate transformations and canvas transformations see Section 68.4.)

The syntax is setup in such a way that is harder to use canvas transformations than coordinate transformations. There are two reasons for this: First, the canvas transformation must be used with great care and often results in “bad” graphics with changing line width and text in wrong sizes. Second, PGF loses track of where nodes and shapes are positioned when canvas transformations are used. So, in almost all circumstances, you should use coordinate transformations rather than canvas transformations.

## 12 Hierarchical Structures: Package, Environments, Scopes, and Styles

The present section explains how your files should be structured when you use TikZ. On the top level, you need to include the `tikz` package. In the main text, each graphic needs to be put in a `{tikzpicture}` environment. Inside these environments, you can use `{scope}` environments to create internal groups. Inside the scopes you use `\path` commands to actually draw something. On all levels (except for the package level), graphic options can be given that apply to everything within the environment.

### 12.1 Loading the Package and the Libraries

```
\usepackage{tikz} %  $\TeX$ 
\input tikz.tex   % plain  $\TeX$ 
\usemodule{tikz}  % Con $\TeX$ t
```

This package does not have any options.

This will automatically load the PGF and the `pgffor` package.

PGF needs to know what  $\TeX$  driver you are intending to use. In most cases PGF is clever enough to determine the correct driver for you; this is true in particular if you use  $\LaTeX$ . Currently, the only situation where PGF cannot know the driver “by itself” is when you use plain  $\TeX$  or Con $\TeX$ t together with `dvipdfm`. In this case, you have to write `\def\pgfsysdriver{pgfsys-dvipdfm.def}` before you input `tikz.tex`.

```
\usetikzlibrary{<list of libraries>}
```

Once TikZ has been loaded, you can use this command to load further libraries. The list of libraries should contain the names of libraries separated by commas. Instead of curly braces, you can also use square brackets, which is something Con $\TeX$ t users will like. If you try to load a library a second time, nothing will happen.

*Example:* `\usetikzlibrary{arrows}`

The above command will load a whole bunch of extra arrow tip definitions.

What this command does is to load the file `tikzlibrary<library>.code.tex` for each `<library>` in the `<list of libraries>`. Thus, to write your own library file, all you need to do is to place a file of the appropriate name somewhere where  $\TeX$  can find it.  $\LaTeX$ , plain  $\TeX$ , and Con $\TeX$ t users can then use your library.

### 12.2 Creating a Picture

#### 12.2.1 Creating a Picture Using an Environment

The “outermost” scope of TikZ is the `{tikzpicture}` environment. You may give drawing commands only inside this environment, giving them outside (as is possible in many other packages) will result in chaos.

In TikZ, the way graphics are rendered is strongly influenced by graphic options. For example, there is an option for setting the color used for drawing, another for setting the color used for filling, and also more obscure ones like the option for setting the prefix used in the filenames of temporary files written while plotting functions using an external program. The graphic options are specified in *key lists*, see Section 12.4 below for details. All graphic options are local to the `{tikzpicture}` to which they apply.

```
\begin{tikzpicture}[<options>]
  <environment contents>
\end{tikzpicture}
```

All TikZ commands should be given inside this environment, except for the `\tikzset` command. Unlike other packages, it is not possible to use, say, `\pgfpathmoveto` outside this environment and doing so will result in chaos. For TikZ, commands like `\path` are only defined inside this environment, so there is little chance that you will do something wrong here.

When this environment is encountered, the `<options>` are parsed, see Section 12.4. All options given here will apply to the whole picture.

Next, the contents of the environment is processed and the graphic commands therein are put into a box. Non-graphic text is suppressed as well as possible, but non-PGF commands inside a `{tikzpicture}`

environment should not produce any “output” since this may totally scramble the positioning system of the backend drivers. The suppressing of normal text, by the way, is done by temporarily switching the font to `\nullfont`. You can, however, “escape back” to normal  $\TeX$  typesetting. This happens, for example, when you specify a node.

At the end of the environment, PGF tries to make a good guess at the size of a bounding box of the graphic and then resizes the picture box such that the box has this size. To “make its guess,” everytime PGF encounters a coordinate, it updates the bounding box’s size such that it encompasses all these coordinates. This will usually give a good approximation of the bounding box, but will not always be accurate. First, the line thickness of diagonal lines is not taken into account correctly. Second, controls points of a curve often lie far “outside” the curve and make the bounding box too large. In this case, you should use the `[use as bounding box]` option.

The following key influences the baseline of the resulting picture:

`/tikz/baseline=<dimension or coordinate>` (default `0pt`)

Normally, the lower end of the picture is put on the baseline of the surrounding text. For example, when you give the code `\tikz\draw(0,0)circle(.5ex);`, PGF will find out that the lower end of the picture is at `-.5ex` and that the upper end is at `.5ex`. Then, the lower end will be put on the baseline, resulting in the following:  $\circ$ .

Using this option, you can specify that the picture should be raised or lowered such that the height `<dimension>` is on the baseline. For example, `\tikz[baseline=0pt]\draw(0,0)circle(.5ex);` yields  $\circ$  since, now, the baseline is on the height of the  $x$ -axis.

This options is often useful for “inlined” graphics as in

|                   |                                                                                       |
|-------------------|---------------------------------------------------------------------------------------|
| $A \rightarrow B$ | <code>\$A \mathbin{\tikz[baseline] \draw[-&gt;] (0pt,.5ex) -- (3ex,.5ex);} B\$</code> |
|-------------------|---------------------------------------------------------------------------------------|

Instead of a `<dimension>` you can also provide a coordinate in parantheses. Then the effect is to put the baseline on the  $y$ -coordinate that the give `<coordinate>` has *at the end of the picture*. This means that, at the end of the picture, the `<coordinate>` is evaluated and then the baseline is set to the  $y$ -coordinate of the resulting point. This makes it easy to reference the  $y$ -coordinate of, say, the base line of nodes.

|                         |                                                                                          |
|-------------------------|------------------------------------------------------------------------------------------|
| Hello <del>world.</del> | <code>Hello<br/>\tikz[baseline=(X.base)]<br/>\node [cross out,draw] (X) {world.};</code> |
|-------------------------|------------------------------------------------------------------------------------------|

|                                                                    |                                                                                                               |
|--------------------------------------------------------------------|---------------------------------------------------------------------------------------------------------------|
| Top align: <input style="width: 40px; height: 15px;" type="text"/> | <code>Top align:<br/>\tikz[baseline=(current bounding box.north)]<br/>\draw (0,0) rectangle (1cm,1ex);</code> |
|--------------------------------------------------------------------|---------------------------------------------------------------------------------------------------------------|

`/tikz/execute at begin picture=<code>` (no default)

This option causes `<code>` to be executed at the beginning of the picture. This option must be given in the argument of the `{tikzpicture}` environment itself since this option will not have an effect otherwise. After all, the picture has already “started” later on. The effect of multiply setting this option accumulates.

This option is mainly used in styles like the `every picture` style to execute certain code at the start of a picture.

`/tikz/execute at end picture=<code>` (no default)

This option installs `<code>` that will be executed at the end of the picture. Using this option multiple times will cause the code to accumulate. This option must also be given in the optional argument of the `{tikzpicture}` environment.



```
\begin{tikzpicture}[execute at end picture=%
{
  \begin{pgfonlayer}{background}
  \path[fill=yellow,rounded corners]
    (current bounding box.south west) rectangle
    (current bounding box.north east);
  \end{pgfonlayer}
}]
\node at (0,0) {X};
\node at (2,1) {Y};
\end{tikzpicture}
```

All options “end” at the end of the picture. To set an option “globally” change the following style:

`/tikz/every picture` (style, initially empty)

This style is installed at the beginning of each picture.

```
\tikzset{every picture/.style=semithick}
```

Note that you should not use `\tikzset` to set options directly. For instance, if you want to use a line width of `1pt` by default, do not try to say `\tikzset{line width=1pt}` at the beginning of your document. This will not work since the line width is changed in many places. Instead, say

```
\tikzset{every picture/.style={line width=1pt}}
```

This will have the desired effect.

In other  $\text{\TeX}$  format, you should use instead the following commands:

```
\tikzpicture[<options>]
  <environment contents>
\endtikzpicture
```

This is the plain  $\text{\TeX}$  version of the environment.

```
\starttikzpicture[<options>]
  <environment contents>
\stoptikzpicture
```

This is the Con $\text{\TeX}$ t version of the environment.

### 12.2.2 Creating a Picture Using a Command

The following two commands are used for “small” graphics.

```
\tikz[<options>]{<commands>}
```

This command places the *<commands>* inside a `{tikzpicture}` environment and adds a semicolon at the end. This is just a convenience.

The *<commands>* may not contain a paragraph (an empty line). This is a precaution to ensure that users really use this command only for small graphics.

*Example:* `\tikz{\draw (0,0) rectangle (2ex,1ex)}` yields  $\square$

```
\tikz[<options>]{<text>};
```

If the *<text>* does not start with an opening brace, the end of the *<text>* is the next semicolon that is encountered.

*Example:* `\tikz \draw (0,0) rectangle (2ex,1ex);` yields  $\square$

### 12.2.3 Adding a Background

By default, pictures do not have any background, that is, they are “transparent” on all parts on which you do not draw anything. You may instead wish to have a colored background behind your picture or a black frame around it or lines above and below it or some other kind of decoration.

Since backgrounds are often not needed at all, the definition of styles for adding backgrounds has been put in the library package `backgrounds`. This package is documented in Section 25.

## 12.3 Using Scopes to Structure a Picture

Inside a `{tikzpicture}` environment you can create scopes using the `{scope}` environment. This environment is available only inside the `{tikzpicture}` environment, so once more, there is little chance of doing anything wrong.

### 12.3.1 The Scope Environment

```
\begin{scope}[\langle options \rangle]
  \langle environment contents \rangle
\end{scope}
```

All *options* are local to the *environment contents*. Furthermore, the clipping path is also local to the environment, that is, any clipping done inside the environment “ends” at its end.



```
\begin{tikzpicture}[ultra thick]
  \begin{scope}[red]
    \draw (0mm,10mm) -- (10mm,10mm);
    \draw (0mm,8mm) -- (10mm,8mm);
  \end{scope}
  \draw (0mm,6mm) -- (10mm,6mm);
  \begin{scope}[green]
    \draw (0mm,4mm) -- (10mm,4mm);
    \draw (0mm,2mm) -- (10mm,2mm);
  \end{scope}
  \draw[blue] (0mm,0mm) -- (10mm,0mm);
\end{tikzpicture}
```

The following style influences scopes:

`/tikz/every scope` (style, initially empty)

This style is installed at the beginning of every scope.

The following options are useful for scopes:

`/tikz/execute at begin scope=code` (no default)

This option install some code that will be executed at the beginning of the scope. This option must be given in the argument of the `{scope}` environment.

The effect applies only to the current scope, not to subscopes.

`/tikz/execute at end scope=code` (no default)

This option installs some code that will be executed at the end of the current scope. Using this option multiple times will cause the code to accumulate. This option must also be given in the optional argument of the `{scope}` environment.

Again, the effect applies only to the current scope, not to subscopes.

```
\scope[\langle options \rangle]
  \langle environment contents \rangle
\endscope
```

Plain  $\text{T}_{\text{E}}\text{X}$  version of the environment.

```
\startscope[\langle options \rangle]
  \langle environment contents \rangle
\stopscope
```

Con $\text{T}_{\text{E}}\text{X}$ t version of the environment.

### 12.3.2 Shorthand for Scope Environments

There is a small library that makes using scopes a bit easier:

```
\usetikzlibrary{scopes} %  $\text{T}_{\text{E}}\text{X}$  and plain  $\text{T}_{\text{E}}\text{X}$ 
\usetikzlibrary[scopes] % Con $\text{T}_{\text{E}}\text{X}$ t
```

This library defines a shorthand for starting and ending `{scope}` environments.

When this library is loaded, the following happens: At certain places inside a TikZ picture, it is allowed to start a scope just using a single brace, provided the single brace is followed by options in square brackets:

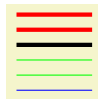

```
\begin{tikzpicture}
{ [ultra thick]
{ [red]
\draw (0mm,10mm) -- (10mm,10mm);
\draw (0mm,8mm) -- (10mm,8mm);
}
\draw (0mm,6mm) -- (10mm,6mm);
}
{ [green]
\draw (0mm,4mm) -- (10mm,4mm);
\draw (0mm,2mm) -- (10mm,2mm);
\draw[blue] (0mm,0mm) -- (10mm,0mm);
}
}\end{tikzpicture}
```

In the above example, `{ [thick]}` actually causes a `\begin{scope}[thick]` to be inserted, and the corresponding closing `}` causes an `\end{scope}` to be inserted.

The “certain places” where an opening brace has this special meaning are the following: First, right after the semicolon that ends a path. Second, right after the end of a scope. Third, right at the beginning of a scope, which includes the beginning of a picture. Also note that some square bracket must follow, otherwise the brace is treated as a normal T<sub>E</sub>X scope.

### 12.3.3 Using Scopes Inside Paths

The `\path` command, which is described in much more detail in later sections, also takes graphic options. These options are local to the path. Furthermore, it is possible to create local scopes within a path simply by using curly braces as in



```
\tikz \draw (0,0) -- (1,1)
{[rounded corners] -- (2,0) -- (3,1)}
-- (3,0) -- (2,1);
```

Note that many options apply only to the path as a whole and cannot be scoped in this way. For example, it is not possible to scope the `color` of the path. See the explanations in the section on paths for more details.

Finally, certain elements that you specify in the argument to the `\path` command also take local options. For example, a node specification takes options. In this case, the options apply only to the node, not to the surrounding path.

## 12.4 Using Graphic Options

### 12.4.1 How Graphic Options Are Processed

Many commands and environments of TikZ accept *options*. These options are so-called *key lists*. To process the options, the following command is used, which you can also call yourself. Note that it is usually better not to call this command directly, since this will ensure that the effect of options are local to a well-defined scope.

`\tikzset{<options>}`

This command will process the `<options>` using the `\pgfkeys` command, documented in detail in Section 55, with the default path set to `/tikz`. Under normal circumstances, the `<options>` will be lists of comma-separated pairs of the form `<key>=<value>`, but more fancy things can happen when you use the power of the `pgfkeys` mechanism, see Section 55 once more.

When a pair `<key>=<value>` is processed, the following happens:

1. If the `<key>` is a full key (starts with a slash) it is handled directly as described in Section 55.
2. Otherwise (which is usually the case), it is checked whether `/tikz/<key>` is a key and, if so, it is executed.
3. Otherwise, it is checked whether `/pgf/<key>` is a key and, if so, it is executed.
4. Otherwise, it is checked whether `<key>` is a color and, if so, `color=<key>` is executed.
5. Otherwise, it is checked whether `<key>` contains a dash and, if so, `arrows=<key>` is executed.



6. Otherwise, it is checked whether  $\langle key \rangle$  is the name of a shape and, if so, `shape= $\langle key \rangle$`  is executed.
7. Otherwise, an error message is printed.

Note that by the above description, all keys starting with `/tikz` and also all keys starting with `/pgf` can be used as  $\langle key \rangle$ s in an  $\langle options \rangle$  list.

### 12.4.2 Using Styles to Manage How Pictures Look

There is a way of organizing sets of graphic options “orthogonally” to the normal scoping mechanism. For example, you might wish all your “help lines” to be drawn in a certain way like, say, gray and thin (do *not* dash them, that distracts). For this, you can use *styles*.

A style is a key that, when used, causes a set of graphic options to be processed. Once a style has been defined, it can be used like any other key. For example, the predefined `help lines` style, which you should use for lines in the background like grid lines or construction lines.

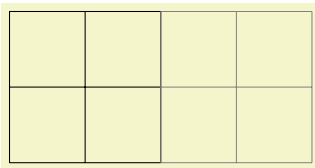

```
\begin{tikzpicture}
  \draw (0,0) grid +(2,2);
  \draw[help lines] (2,0) grid +(2,2);
\end{tikzpicture}
```

Defining styles is also done using options. Suppose we wish to define a style called `my style` and when this style is used, we want the draw color to be set to `red` and the fill color be set to `red!20`. To achieve this, we use the following option:

```
my style/.style={draw=red,fill=red!20}
```

The meaning of the curious `/.style` is the following: “The key `my style` should not be used here but, rather, be defined. So, setup things such that using the key `my style` will, in the following, have the same effect as if we had written `draw=red,fill=red!20` instead.”

Returning to the help lines example, suppose we prefer blue help lines. This could be achieved as follows:

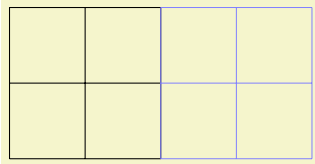

```
\begin{tikzpicture}[help lines/.style={blue!50,very thin}]
  \draw (0,0) grid +(2,2);
  \draw[help lines] (2,0) grid +(2,2);
\end{tikzpicture}
```

Naturally, one of the main ideas behind styles is that they can be used in different pictures. In this case, we have to use the `\tikzset` command somewhere at the beginning.

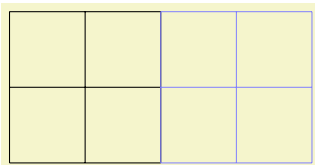

```
\tikzset{help lines/.style={blue!50,very thin}}
% ...
\begin{tikzpicture}
  \draw (0,0) grid +(2,2);
  \draw[help lines] (2,0) grid +(2,2);
\end{tikzpicture}
```

Since styles are just special cases of `pgfkeys`’s general style facility, you can actually do quite a bit more. Let us start with adding options to an already existing style. This is done using `/.append style` instead of `/.style`:

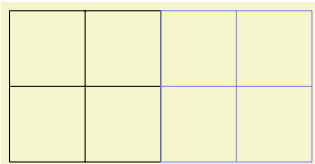

```
\begin{tikzpicture}[help lines/.append style=blue!50]
  \draw (0,0) grid +(2,2);
  \draw[help lines] (2,0) grid +(2,2);
\end{tikzpicture}
```

In the above example, the option `blue!50` is appended to the style `help lines`, which now has the same effect as `black!50,very thin,blue!50`. Note that two colors are set, so the last one will “win.” There also exists a handler called `/.prefix style` that adds something at the beginning of the style.

Just as normal keys, styles can be parametrized. This means that you write  $\langle style \rangle = \langle value \rangle$  when you use the style instead of just  $\langle style \rangle$ . In this case, all occurrences of `#1` in  $\langle style \rangle$  are replaced by  $\langle value \rangle$ . Here is an example that shows how this can be used.



|      |                                                                                                                                                                           |
|------|---------------------------------------------------------------------------------------------------------------------------------------------------------------------------|
| red  | <pre>\begin{tikzpicture}[outline/.style={draw=#1,thick,fill=#1!50}]   \node [outline=red] at (0,1) {red};   \node [outline=blue] at (0,0) {blue}; \end{tikzpicture}</pre> |
| blue |                                                                                                                                                                           |

For parametrized styles you can also set a *default* value using the `/.default` handler:

|         |                                                                                                                                                                                                     |
|---------|-----------------------------------------------------------------------------------------------------------------------------------------------------------------------------------------------------|
| default | <pre>\begin{tikzpicture}[outline/.style={draw=#1,thick,fill=#1!50},   outline/.default=black]   \node [outline] at (0,1) {default};   \node [outline=blue] at (0,0) {blue}; \end{tikzpicture}</pre> |
| blue    |                                                                                                                                                                                                     |

For more details on using and setting styles, see also Section 55.

## 13 Specifying Coordinates

### 13.1 Overview

A *coordinate* is a position on the canvas on which your picture is drawn. TikZ uses a special syntax for specifying coordinates. Coordinates are always put in round brackets. The general syntax is (*[⟨options⟩]* *⟨coordinate specification⟩*).

The *⟨coordinate specification⟩* specified coordinates using one of many different possible *coordinate systems*. Examples are the Cartesian coordinate system or polar coordinates or spherical coordinates. No matter which coordinate system is used, in the end, a specific point on the canvas is represented by the coordinate.

There are two ways of specifying which coordinate system should be used:

**Explicitly** You can specify the coordinate system explicitly. To do so, you give the name of the coordinate system at the beginning, followed by `cs:`, which stands for “coordinate system,” followed by a specification of the coordinate using the key-value syntax. Thus, the general syntax for *⟨coordinate specification⟩* in the explicit case is (*⟨coordinate system⟩ cs:⟨list of key-value pairs specific to the coordinate system⟩*).

**Implicitly** The explicit specification is often too verbose when numerous coordinates should be given. Because of this, for the coordinate systems that you are likely to use often a special syntax is provided. TikZ will notice when you use a coordinate specified in a special syntax and will choose the correct coordinate system automatically.

Here is an example in which explicit the coordinate systems are specified explicitly:

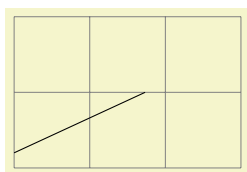

```
\begin{tikzpicture}
  \draw[help lines] (0,0) grid (3,2);
  \draw (canvas cs:x=0cm,y=2mm)
    -- (canvas polar cs:radius=2cm,angle=30);
\end{tikzpicture}
```

In the next example, the coordinate systems are implicit:

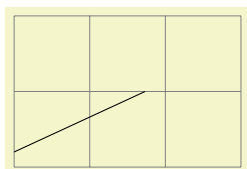

```
\begin{tikzpicture}
  \draw[help lines] (0,0) grid (3,2);
  \draw (0cm,2mm) -- (30:2cm);
\end{tikzpicture}
```

It is possible to give options that apply only to a single coordinate, although this makes sense for transformation options only. To give transformation options for a single coordinate, give these options at the beginning in brackets:

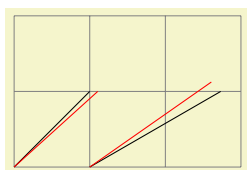

```
\begin{tikzpicture}
  \draw[help lines] (0,0) grid (3,2);
  \draw (0,0) -- (1,1);
  \draw[red] (0,0) -- ([xshift=3pt] 1,1);
  \draw (1,0) -- +(30:2cm);
  \draw[red] (1,0) -- +([shift=(135:5pt)] 30:2cm);
\end{tikzpicture}
```

## 13.2 Coordinate Systems

### 13.2.1 Canvas, XYZ, and Polar Coordinate Systems

Let us start with the basic coordinate systems.

Coordinate system **canvas**

The simplest way of specifying a coordinate is to use the **canvas** coordinate system. You provide a dimension  $d_x$  using the `x=` option and another dimension  $d_y$  using the `y=` option. The position on the canvas is located at the position that is  $d_x$  to the right and  $d_y$  above the origin.

`/tikz/cs/x=<dimension>` (no default, initially 0pt)

Distance by which the coordinate is to the right of the origin. You can also write things like `1cm+2pt` since the mathematical engine is used to evaluate the `<dimension>`.

`/tikz/cs/y=<dimension>` (no default, initially 0pt)

Distance by which the coordinate is above the origin.

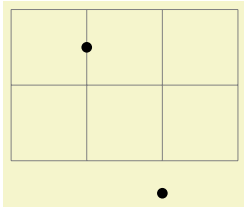

```
\begin{tikzpicture}
\draw[help lines] (0,0) grid (3,2);

\fill (canvas cs:x=1cm,y=1.5cm) circle (2pt);
\fill (canvas cs:x=2cm,y=-5mm+2pt) circle (2pt);
\end{tikzpicture}
```

To specify a coordinate in the coordinate system implicitly, you use two dimensions that are separated by a comma as in `(0cm,3pt)` or `(2cm,\textheight)`.

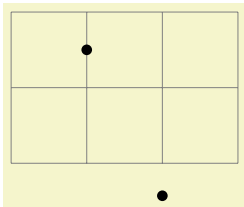

```
\begin{tikzpicture}
\draw[help lines] (0,0) grid (3,2);

\fill (1cm,1.5cm) circle (2pt);
\fill (2cm,-5mm+2pt) circle (2pt);
\end{tikzpicture}
```

### Coordinate system `xyz`

The `xyz` coordinate system allows you to specify a point as a multiple of three vectors called the  $x$ -,  $y$ -, and  $z$ -vectors. By default, the  $x$ -vector points 1cm to the right, the  $y$ -vector points 1cm upwards, but this can be changed arbitrarily as explained in Section 22.2. The default  $z$ -vector points to  $(-\frac{1}{\sqrt{2}}\text{cm}, -\frac{1}{\sqrt{2}}\text{cm})$ .

To specify the factors by which the vectors should be multiplied before being added, you use the following three options:

`/tikz/cs/x=<factor>` (no default, initially 0)

Factor by which the  $x$ -vector is multiplied.

`/tikz/cs/y=<factor>` (no default, initially 0)

Works like `x`.

`/tikz/cs/z=<factor>` (no default, initially 0)

Works like `x`.

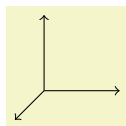

```
\begin{tikzpicture}[->]
\draw (0,0) -- (xyz cs:x=1);
\draw (0,0) -- (xyz cs:y=1);
\draw (0,0) -- (xyz cs:z=1);
\end{tikzpicture}
```

This coordinate system can also be selected implicitly. To do so, you just provide two or three comma-separated factors (not dimensions).

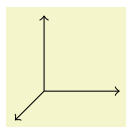

```
\begin{tikzpicture}[->]
\draw (0,0) -- (1,0);
\draw (0,0) -- (0,1,0);
\draw (0,0) -- (0,0,1);
\end{tikzpicture}
```

*Note:* It is possible to use coordinates like `(1,2cm)`, which are neither `canvas` coordinates nor `xyz` coordinates. The rule is the following: If a coordinate is of the implicit form `(<x>,<y>)`, then `<x>` and `<y>`

are checked, independently, whether they have a dimension or whether they are dimensionless. If both have a dimension, the `canvas` coordinate system is used. If both lack a dimension, the `xyz` coordinate system is used. If  $\langle x \rangle$  has a dimension and  $\langle y \rangle$  has not, then the sum of two coordinate  $(\langle x \rangle, 0\text{pt})$  and  $(0, \langle y \rangle)$  is used. If  $\langle y \rangle$  has a dimension and  $\langle x \rangle$  has not, then the sum of two coordinate  $(\langle x \rangle, 0)$  and  $(0\text{pt}, \langle y \rangle)$  is used.

*Note furthermore:* An expression like  $(2+3\text{cm}, 0)$  does *not* mean the same as  $(2\text{cm}+3\text{cm}, 0)$ . Instead, if  $\langle x \rangle$  or  $\langle y \rangle$  internally uses a mixture of dimensions and dimensionless values, then all dimensionless values are “upgraded” to dimensions by interpreting them as `pt`. So,  $2+3\text{cm}$  is the same dimension as  $2\text{pt}+3\text{cm}$ .

### Coordinate system `canvas polar`

The `canvas polar` coordinate system allows you to specify polar coordinates. You provide an angle using the `angle=` option and a radius using the `radius=` option. This yields the point on the canvas that is at the given radius distance from the origin at the given degree. A degree of zero points to the right, a degree of 90 upward.

`/tikz/cs/angle= $\langle degrees \rangle$`  (no default)

The angle of the coordinate. The angle must always be given in degrees and should be between  $-360$  and  $720$ .

`/tikz/cs/radius= $\langle dimension \rangle$`  (no default)

The distance from the origin.

`/tikz/cs/x radius= $\langle dimension \rangle$`  (no default)

A polar coordinate is, after all, just a point on a circle of the given  $\langle radius \rangle$ . When you provide an  $x$ -radius and also a  $y$ -radius, you specify an ellipse instead of a circle. The `radius` option has the same effect as specifying identical `x radius` and `y radius` options.

`/tikz/cs/y radius= $\langle dimension \rangle$`  (no default)

Works like `x radius`.



```
\tikz \draw (0,0) -- (canvas polar cs:angle=30,radius=1cm);
```

The implicit form for canvas polar coordinates is the following: you specify the angle and the distance, separated by a colon as in  $(30:1\text{cm})$ .

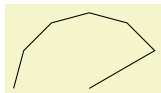

```
\tikz \draw (0cm,0cm) -- (30:1cm) -- (60:1cm) -- (90:1cm)
-- (120:1cm) -- (150:1cm) -- (180:1cm);
```

Two different radii are specified by writing  $(30:1\text{cm}$  and  $2\text{cm})$ .

For the implicit form, instead of an angle given as a number you can also use certain words. For example, `up` is the same as  $90$ , so that you can write `\tikz \draw (0,0) -- (2ex,0pt) -- +(up:1ex)`; and get `└`. Apart from `up` you can use `down`, `left`, `right`, `north`, `south`, `west`, `east`, `north east`, `north west`, `south east`, `south west`, all of which have their natural meaning.

### Coordinate system `xyz polar`

This coordinate system work similarly to the `canvas polar` system. However, the radius and the angle are interpreted in the  $xy$ -coordinate system, not in the canvas system. More detailed, consider the circle or ellipse whose half axes are given by the current  $x$ -vector and the current  $y$ -vector. Then, consider the point that lies at a given angle on this ellipse, where an angle of zero is the same as the  $x$ -vector and an angle of  $90$  is the  $y$ -vector. Finally, multiply the resulting vector by the given radius factor. Voilà.

`/tikz/cs/angle= $\langle degrees \rangle$`  (no default)

The angle of the coordinate interpreted in the ellipse whose axes are the  $x$ -vector and the  $y$ -vector.

`/tikz/cs/radius= $\langle factor \rangle$`  (no default)

A factor by which the  $x$ -vector and  $y$ -vector are multiplied prior to forming the ellipse.

`/tikz/cs/x radius=<dimension>` (no default)

A specific factor by which only the  $x$ -vector is multiplied.

`/tikz/cs/y radius=<dimension>` (no default)

Works like `x radius`.

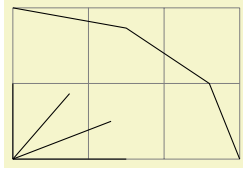

```
\begin{tikzpicture}[x=1.5cm,y=1cm]
\draw[help lines] (0cm,0cm) grid (3cm,2cm);

\draw (0,0) -- (xyz polar cs:angle=0,radius=1);
\draw (0,0) -- (xyz polar cs:angle=30,radius=1);
\draw (0,0) -- (xyz polar cs:angle=60,radius=1);
\draw (0,0) -- (xyz polar cs:angle=90,radius=1);

\draw (xyz polar cs:angle=0,radius=2)
-- (xyz polar cs:angle=30,radius=2)
-- (xyz polar cs:angle=60,radius=2)
-- (xyz polar cs:angle=90,radius=2);
\end{tikzpicture}
```

The implicit version of this option is the same as the implicit version of `canvas polar`, only you do not provide a unit.



```
\tikz[x={(0cm,1cm)},y={(-1cm,0cm)}]
\draw (0,0) -- (30:1) -- (60:1) -- (90:1)
-- (120:1) -- (150:1) -- (180:1);
```

Coordinate system **xy polar**

This is just an alias for `xyz polar`, which some people might prefer as there is no  $z$ -coordinate involved in the `xyz polar` coordinates.

### 13.2.2 Barycentric Systems

In the barycentric coordinate system a point is expressed as the linear combination of multiple vectors. The idea is that you specify vectors  $v_1, v_2, \dots, v_n$  and numbers  $\alpha_1, \alpha_2, \dots, \alpha_n$ . Then the barycentric coordinate specified by these vectors and numbers is

$$\frac{\alpha_1 v_1 + \alpha_2 v_2 + \dots + \alpha_n v_n}{\alpha_1 + \alpha_2 + \dots + \alpha_n}$$

The `barycentric cs` allows you to specify such coordinates easily.

Coordinate system **barycentric**

For this coordinate system, the `<coordinate specification>` should be a comma-separated list of expressions of the form `<node name>=<number>`. Note that (currently) the list should not contain any spaces before or after the `<node name>` (unlike normal key-value pairs).

The specified coordinate is now computed as follows: Each pair provides one vector and a number. The vector is the **center** anchor of the `<node name>`. The number is the `<number>`. Note that (currently) you cannot specify a different anchor, so that in order to use, say, the **north** anchor of a node you first have to create a new coordinate at this north anchor. (Using for instance `\coordinate(mynorth) at (mynode.north);`)

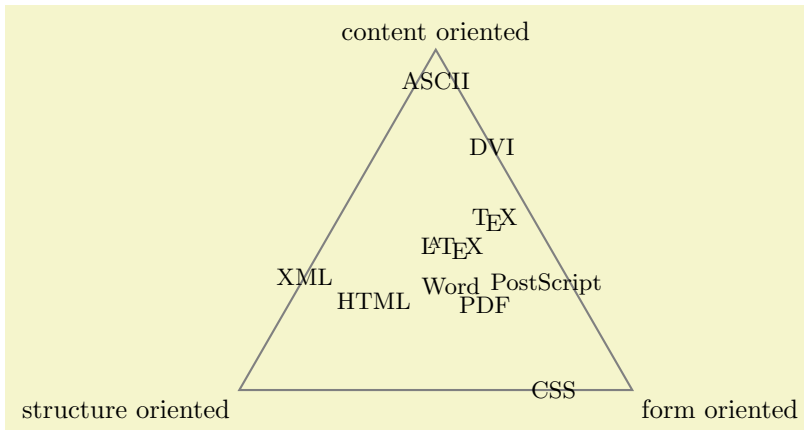

```

\begin{tikzpicture}
  \coordinate (content) at (90:3cm);
  \coordinate (structure) at (210:3cm);
  \coordinate (form) at (-30:3cm);

  \node [above] at (content) {content oriented};
  \node [below left] at (structure) {structure oriented};
  \node [below right] at (form) {form oriented};

  \draw [thick,gray] (content.south) -- (structure.north east) -- (form.north west) -- cycle;

  \small
  \node at (barycentric cs:content=0.5,structure=0.1 ,form=1) {PostScript};
  \node at (barycentric cs:content=1 ,structure=0 ,form=0.4) {DVI};
  \node at (barycentric cs:content=0.5,structure=0.5 ,form=1) {PDF};
  \node at (barycentric cs:content=0 ,structure=0.25,form=1) {CSS};
  \node at (barycentric cs:content=0.5,structure=1 ,form=0) {XML};
  \node at (barycentric cs:content=0.5,structure=1 ,form=0.4) {HTML};
  \node at (barycentric cs:content=1 ,structure=0.2 ,form=0.8) {\TeX};
  \node at (barycentric cs:content=1 ,structure=0.6 ,form=0.8) {\LaTeX};
  \node at (barycentric cs:content=0.8,structure=0.8 ,form=1) {Word};
  \node at (barycentric cs:content=1 ,structure=0.05,form=0.05) {ASCII};
\end{tikzpicture}

```

### 13.2.3 Node Coordinate System

In PGF and in TikZ it is quite easy to define a node that you wish to reference at a later point. Once you have defined a node, there are different ways of referencing points of the node. To do so, you use the following coordinate system:

Coordinate system **node**

This coordinate system is used to reference a specific point inside or on the border of a previously defined node. It can be used in different ways, so let us go over them one by one.

You can use three options to specify which coordinate you mean:

**/tikz/cs/name**=*<node name>* (no default)

Specifies the node in which you wish to specify a coordinate. The *<node name>* is the name that was previously used to name the node using the **name**=*<node name>* option or the special node name syntax.

**/tikz/anchor**=*<anchor>* (no default)

Specifies an anchor of the node. Here is an example:

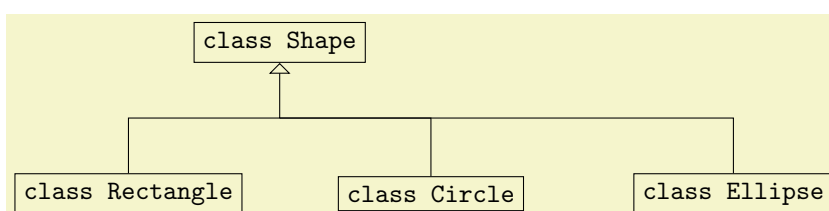

```

\begin{tikzpicture}
  \node (shape) at (0,2) [draw] {\class Shape|};
  \node (rect) at (-2,0) [draw] {\class Rectangle|};
  \node (circle) at (2,0) [draw] {\class Circle|};
  \node (ellipse) at (6,0) [draw] {\class Ellipse|};

  \draw (node cs:name=circle,anchor=north) |- (0,1);
  \draw (node cs:name=ellipse,anchor=north) |- (0,1);
  \draw[-open triangle 90] (node cs:name=rect,anchor=north)
    |- (0,1) -| (node cs:name=shape,anchor=south);
\end{tikzpicture}

```

`/tikz/cs/angle=<degrees>`

(no default)

It is also possible to provide an angle *instead* of an anchor. This coordinate refers to a point of the node's border where a ray shot from the center in the given angle hits the border. Here is an example:

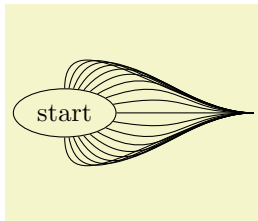

```

\begin{tikzpicture}
  \node (start) [draw,shape=ellipse] {start};
  \foreach \angle in {-90, -80, ..., 90}
    \draw (node cs:name=start,angle=\angle)
      .. controls +(\angle:1cm) and +(-1,0) .. (2.5,0);
\end{tikzpicture}

```

It is possible to provide *neither* the `anchor=` option nor the `angle=` option. In this case, TikZ will calculate an appropriate border position for you. Here is an example:

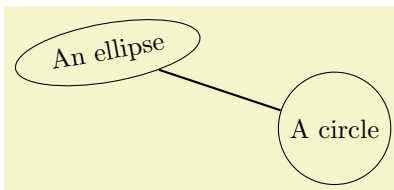

```

\begin{tikzpicture}
  \path (0,0) node(a) [ellipse,rotate=10,draw] {An ellipse}
    (3,-1) node(b) [circle,draw] {A circle};
  \draw[thick] (node cs:name=a) -- (node cs:name=b);
\end{tikzpicture}

```

TikZ will be reasonably clever at determining the border points that you “mean,” but, naturally, this may fail in some situations. If TikZ fails to determine an appropriate border point, the center will be used instead.

Automatic computation of anchors works only with the line-to operations `--`, the vertical/horizontal versions `|-` and `-|`, and with the curve-to operation `...`. For other path commands, such as `parabola` or `plot`, the center will be used. If this is not desired, you should give a named anchor or an angle anchor. Note that if you use an automatic coordinate for both the start and the end of a line-to, as in `--(node cs:name=b)--`, then *two* border coordinates are computed with a move-to between them. This is usually exactly what you want.

If you use relative coordinates together with automatic anchor coordinates, the relative coordinates are computed relative to the node's center, not relative to the border point. Here is an example:

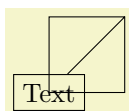

```

\tikz \draw (0,0) node(x) [draw] {Text}
  rectangle (1,1)
  (node cs:name=x) -- +(1,1);

```

Similarly, in the following examples both control points are (1, 1):

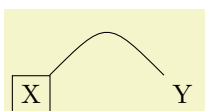

```

\tikz \draw (0,0) node(x) [draw] {X}
  (2,0) node(y) {Y}
  (node cs:name=x) .. controls +(1,1) and +(-1,1) ..
  (node cs:name=y);

```

The implicit way of specifying the node coordinate system is to simply use the name of the node in parentheses as in (a) or to specify a name together with an anchor or an angle separated by a dot as in (a.north) or (a.10).

Here is a more complete example:

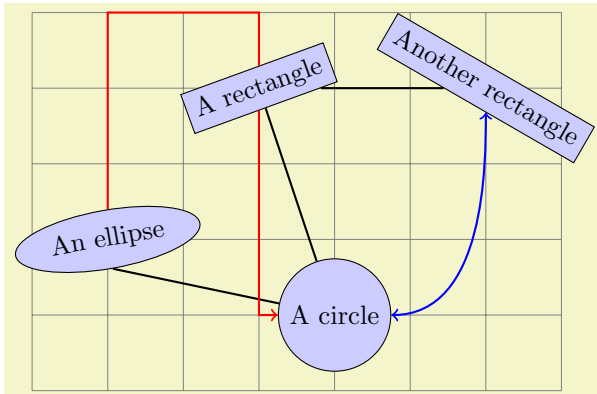

```
\begin{tikzpicture}[fill=blue!20]
  \draw[help lines] (-1,-2) grid (6,3);
  \path (0,0) node(a) [ellipse,rotate=10,draw,fill] {An ellipse}
        (3,-1) node(b) [circle,draw,fill] {A circle}
        (2,2) node(c) [rectangle,rotate=20,draw,fill] {A rectangle}
        (5,2) node(d) [rectangle,rotate=-30,draw,fill] {Another rectangle};
  \draw[thick] (a.south) -- (b) -- (c) -- (d);
  \draw[thick,red,->] (a) |- +(1,3) -| (c) |- (b);
  \draw[thick,blue,<->] (b) .. controls +(right:2cm) and +(down:1cm) .. (d);
\end{tikzpicture}
```

### 13.2.4 Tangent Coordinate Systems

Coordinate system **tangent**

This coordinate system, which is available only when the TikZ library `calc` is loaded, allows you to compute the point that lies tangent to a shape. In detail, consider a *node* and a *point*. Now, draw a straight line from the *point* so that it “touches” the *node* (more formally, so that it is *tangent* to this *node*). The point where the line touches the shape is the point referred to by the **tangent** coordinate system.

The following options may be given:

`/tikz/cs/node=<node>` (no default)

This key specifies the node on whose border the tangent should lie.

`/tikz/cs/point=<point>` (no default)

This key specifies the point through which the tangent should go.

`/tikz/cs/solution=<number>` (no default)

Specifies which solution should be used if there are more than one.

A special algorithm is needed in order to compute the tangent for a given shape. Currently, tangents can be computed for nodes whose shape is one of the following:

- `coordinate`
- `circle`



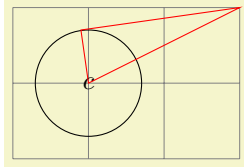

```
\begin{tikzpicture}
\draw[help lines] (0,0) grid (3,2);

\coordinate (a) at (3,2);

\node [circle,draw] (c) at (1,1) [minimum size=40pt] {$c$};

\draw[red] (a) -- (tangent cs:node=c,point={a},solution=1) --
(c.center) -- (tangent cs:node=c,point={a},solution=2) -- cycle;
\end{tikzpicture}
```

There is no implicit syntax for this coordinate system.

### 13.2.5 Defining New Coordinate Systems

While the set of coordinate systems that TikZ can parse via their special syntax is fixed, it is possible and quite easy to define new explicitly named coordinate systems. For this, the following commands are used:

**`\tikzdeclarecoordinatesystem{<name>}{<code>}`**

This command declares a new coordinate system named *<name>* that can later on be used by writing *(<name> cs:<arguments>)*. When TikZ encounters a coordinate specified in this way, the *<arguments>* are passed to *<code>* as argument #1.

It is now the job of *<code>* to make sense of the *<arguments>*. At the end of *<code>*, the two TeX dimensions `\pgf@x` and `\pgf@y` should have the *x*- and *y*-canvas coordinate of the coordinate.

It is not necessary, but customary, to parse *<arguments>* using the key-value syntax. However, you can also parse it in any way you like.

In the following example, a coordinate system `cylindrical` is defined.

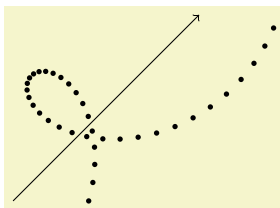

```
\makeatletter
\define@key{cylindricalkeys}{angle}{\def\myangle{#1}}
\define@key{cylindricalkeys}{radius}{\def\myradius{#1}}
\define@key{cylindricalkeys}{z}{\def\myz{#1}}
\tikzdeclarecoordinatesystem{cylindrical}%
{%
\setkeys{cylindricalkeys}{#1}%
\pgfpointadd{\pgfpointxyz{0}{0}{\myz}}{\pgfpointpolarxy{\myangle}{\myradius}}
}
\begin{tikzpicture}[z=0.2pt]
\draw [->] (0,0,0) -- (0,0,350);
\foreach \num in {0,10,...,350}
\fill (cylindrical cs:angle=\num,radius=1,z=\num) circle (1pt);
\end{tikzpicture}
```

**`\tikzaliascoordinatesystem{<new name>}{<old name>}`**

Creates an alias of *<old name>*.

## 13.3 Coordinates at Intersections

You will wish to compute the intersection of two paths. For the special and frequent case of two perpendicular lines, a special coordinate system called `perpendicular` is available. For more general cases, the `intersection` library can be used.

### 13.3.1 Intersections of Perpendicular Lines

A frequent special case of path intersections is the intersection of a vertical line going through a point *p* and a horizontal line going through some other point *q*. For this situation there is a useful coordinate system.

Coordinate system `perpendicular`

You can specify the two lines using the following keys:

**`/tikz/cs/horizontal line through={(<coordinate>)}`** (no default)

Specifies that one line is a horizontal line that goes through the given coordinate.

`/tikz/cs/vertical line through={(coordinate)}` (no default)

Specifies that the other line is vertical and goes through the given coordinate.

However, in almost all cases you should, instead, use the implicit syntax. Here, you write `(p) |- (q)` or `(q) -| (p)`.

For example, `(2,1 |- 3,4)` and `(3,4 -| 2,1)` both yield the same as `(2,4)` (provided the *xy*-coordinate system has not been modified).

The most useful application of the syntax is to draw a line up to some point on a vertical or horizontal line. Here is an example:

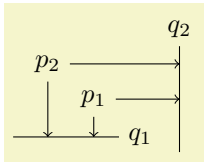

```
\begin{tikzpicture}
  \path (30:1cm) node(p1) {$p_1$}   (75:1cm) node(p2) {$p_2$};

  \draw (-0.2,0) -- (1.2,0) node(xline)[right] {$q_1$};
  \draw (2,-0.2) -- (2,1.2) node(yline)[above] {$q_2$};

  \draw[->] (p1) -- (p1 |- xline);
  \draw[->] (p2) -- (p2 |- xline);
  \draw[->] (p1) -- (p1 -| yline);
  \draw[->] (p2) -- (p2 -| yline);
\end{tikzpicture}
```

### 13.3.2 Intersections of Arbitrary Paths

```
\usetikzlibrary{intersections} %  $\TeX$  and plain  $\TeX$ 
\usetikzlibrary[intersections] % Con $\TeX$ t
```

This library enables the calculation of intersections of two arbitrary paths. However, due to the low accuracy of  $\TeX$ , the paths should not be “too complicated”. In particular, you should not try to intersect paths consisting lots of very small segments such as plots or decorated paths.

To find the intersections of two paths in *TikZ*, they must be “named”. A “named path” is, quite simply, a path that has been named using the following key:

`/tikz/name path=(name)` (no default)

The effect of this key is that, after the path has been constructed, just before it is used, it is associated with *(name)*. This association survives beyond the final semi-colon of the path but not the end of the surrounding scope. Any paths created by nodes on the (main) path are ignored, unless this key is explicitly used. If the same *(name)* is used for the main path and the node path(s), then the paths will be added together and then associated with *(name)*.

To find the intersection of named paths, the following key is used:

`/tikz/name intersections={(options)}` (no default)

This key changes the key path to `/tikz/intersection` and processes *(options)*. These options determine, among other things, which paths to use for the intersection. Having processed the options, any intersections are then found. A coordinate is created at each intersection, which by default, will be named `intersection-1`, `intersection-2`, and so on. Optionally, the prefix `intersection` can be changed, and the total number of intersections stored in a  $\TeX$ -macro.

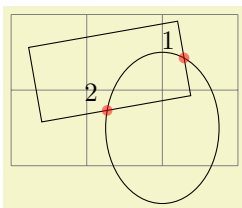

```
\begin{tikzpicture}[every node/.style={opacity=1, black, above left}]
  \draw [help lines] grid (3,2);
  \draw [name path=ellipse] (2,0.5) ellipse (0.75cm and 1cm);
  \draw [name path=rectangle, rotate=10] (0.5,0.5) rectangle +(2,1);
  \fill [red, opacity=0.5, name intersections={of=ellipse and rectangle}]
    (intersection-1) circle (2pt) node {1}
    (intersection-2) circle (2pt) node {2};
\end{tikzpicture}
```

The following keys can be used in *(options)*:

`/tikz/intersection/of=(name path 1) and (name path 2)` (no default)

This key is used to specify the names of the paths to use for the intersection.

`/tikz/intersection/name=<prefix>` (no default, initially `intersection`)

This key specifies the prefix name for the coordinate nodes placed at each intersection.

`/tikz/intersection/total=<macro>` (no default)

This key will mean that the total number of intersections found will be stored in `<macro>`.

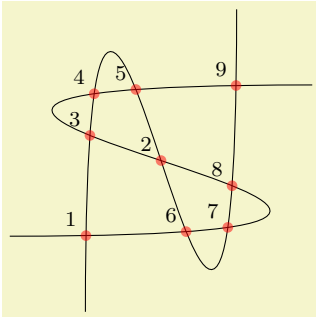

```
\begin{tikzpicture}
\clip (-2,-2) rectangle (2,2);
\draw [name path=curve 1] (-2,-1) .. controls (8,-1) and (-8,1) .. (2,1);
\draw [name path=curve 2] (-1,-2) .. controls (-1,8) and (1,-8) .. (1,2);

\fill [name intersections={of=curve 1 and curve 2, name=i, total=\t}]
[red, opacity=0.5, every node/.style={above left, black, opacity=1}]
\foreach \s in {1,...,\t}{(i-\s) circle (2pt) node {\footnotesize\s}};
\end{tikzpicture}
```

`/tikz/intersection/by=<comma-separated list>` (no default)

This key allows you to specify a list of names for the intersection coordinates. The intersection coordinates will still be named `<prefix>-<number>`, but additionally the first coordinate will also be named by the first element of the `<comma-separated list>`. What happens is that the `<comma-separated list>` is passed to the `\foreach` statement and for `<list member>` a coordinate is created at the already-named intersection.

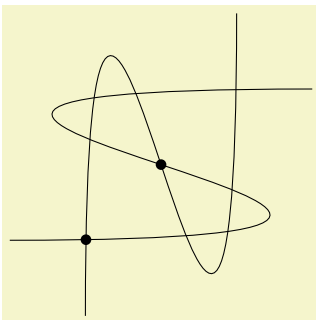

```
\begin{tikzpicture}
\clip (-2,-2) rectangle (2,2);
\draw [name path=curve 1] (-2,-1) .. controls (8,-1) and (-8,1) .. (2,1);
\draw [name path=curve 2] (-1,-2) .. controls (-1,8) and (1,-8) .. (1,2);

\fill [name intersections={of=curve 1 and curve 2, by={a,b}}]
(a) circle (2pt)
(b) circle (2pt);
\end{tikzpicture}
```

You can also use the `...` notation of the `\foreach` statement inside the `<comma-separated list>`.

In case an element of the `<comma-separated list>` starts with options in square brackets, these options are used when the coordinate is created. A coordinate name can still, but need not, follow the options. This makes it easy to add labels to intersections:

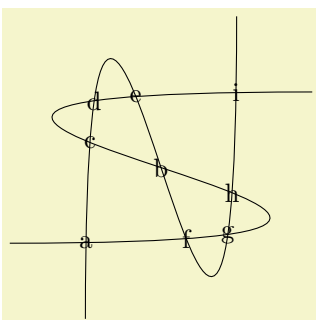

```
\begin{tikzpicture}
\clip (-2,-2) rectangle (2,2);
\draw [name path=curve 1] (-2,-1) .. controls (8,-1) and (-8,1) .. (2,1);
\draw [name path=curve 2] (-1,-2) .. controls (-1,8) and (1,-8) .. (1,2);

\fill [name intersections={
of=curve 1 and curve 2,
by={ [label=center:a], [label=center:...], [label=center:i] }];
\end{tikzpicture}
```

`/tikz/intersection/sort by=<path name>` (no default)

By default, the intersections are simply returned in the order that the intersection algorithm finds them. Unfortunately, this is not necessarily a “helpful” ordering. This key can be used to sort the intersections along the path specified by `<path name>`, which should be one of the paths mentioned in the `/tikz/intersection/of` key.

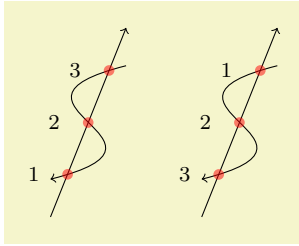

```

\begin{tikzpicture}
\clip (-0.5,-0.75) rectangle (3.25,2.25);
\foreach \pathname/\shift in {line/0cm, curve/2cm}{
\tikzset{xshift=\shift}
\draw [->, name path=curve] (1,1.5) .. controls (-1,1) and (2,0.5) .. (0,0);
\draw [->, name path=line] (0,-.5) -- (1,2);
\fill [name intersections={of=line and curve,sort by=\pathname, name=i}]
[red, opacity=0.5, every node/.style={left=.25cm, black, opacity=1}]
\foreach \s in {1,2,3}{(i-\s) circle (2pt) node {\footnotesize\s}};
}
\end{tikzpicture}

```

## 13.4 Relative and Incremental Coordinates

### 13.4.1 Specifying Relative Coordinates

You can prefix coordinates by ++ to make them “relative.” A coordinate such as ++(1cm,0pt) means “1cm to the right of the previous position.” Relative coordinates are often useful in “local” contexts:

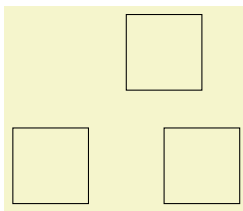

```

\begin{tikzpicture}
\draw (0,0) -- ++(1,0) -- ++(0,1) -- ++(-1,0) -- cycle;
\draw (2,0) -- ++(1,0) -- ++(0,1) -- ++(-1,0) -- cycle;
\draw (1.5,1.5) -- ++(1,0) -- ++(0,1) -- ++(-1,0) -- cycle;
\end{tikzpicture}

```

Instead of ++ you can also use a single +. This also specifies a relative coordinate, but it does not “update” the current point for subsequent usages of relative coordinates. Thus, you can use this notation to specify numerous points, all relative to the same “initial” point:

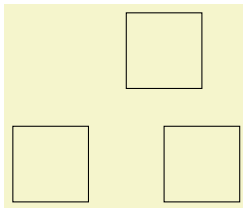

```

\begin{tikzpicture}
\draw (0,0) -- +(1,0) -- +(1,1) -- +(0,1) -- cycle;
\draw (2,0) -- +(1,0) -- +(1,1) -- +(0,1) -- cycle;
\draw (1.5,1.5) -- +(1,0) -- +(1,1) -- +(0,1) -- cycle;
\end{tikzpicture}

```

There is a special situation, where relative coordinates are interpreted differently. If you use a relative coordinate as a control point of a Bézier curve, the following rule applies: First, a relative first control point is taken relative to the beginning of the curve. Second, a relative second control point is taken relative to the end of the curve. Third, a relative end point of a curve is taken relative to the start of the curve.

This special behavior makes it easy to specify that a curve should “leave or arrives from a certain direction” at the start or end. In the following example, the curve “leaves” at 30° and “arrives” at 60°:

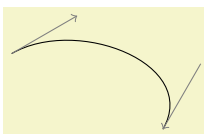

```

\begin{tikzpicture}
\draw (1,0) .. controls +(30:1cm) and +(60:1cm) .. (3,-1);
\draw[gray,->] (1,0) -- +(30:1cm);
\draw[gray,<-] (3,-1) -- +(60:1cm);
\end{tikzpicture}

```

### 13.4.2 Relative Coordinates and Scopes

An interesting question is, how do relative coordinates behave in the presence of scopes? That is, suppose we use curly braces in a path to make part of it “local,” how does that affect the current position? On the one hand, the current position certainly changes since the scope only affects options, not the path itself. On the other hand, it may be useful to “temporarily escape” from the updating of the current point.

Since both interpretations of how the current point and scopes should “interact” are useful, there is a (local!) option that allows you to decide which you need.

`/tikz/current point is local=<boolean>` (no default, initially false)

Normally, the scope path operation has no effect on the current point. That is, curly braces on a path have no effect on the current position:



### 13.5.2 The Syntax of Factors

The  $\langle factor \rangle$ s are optional and detected by checking whether the  $\langle coordinate computation \rangle$  starts with a  $($ . Also, after each  $\pm$  a  $\langle factor \rangle$  is present if, and only if, the  $+$  or  $-$  sign is not directly followed by  $($ .

If a  $\langle factor \rangle$  is present, it is evaluated using the `\pgfmathparse` macro. This means that you can use pretty complicated computations inside a factor. A  $\langle factor \rangle$  may even contain opening parentheses, which creates a complication: How does TikZ know where a  $\langle factor \rangle$  ends and where a coordinate starts? For instance, if the beginning of a  $\langle coordinate computation \rangle$  is  $2*(3+4\dots$ , it is not clear whether  $3+4$  is part of a  $\langle coordinate \rangle$  or part of a  $\langle factor \rangle$ . Because of this, the following rule is used: Once it has been determined, that a  $\langle factor \rangle$  is present, in principle, the  $\langle factor \rangle$  contains everything up to the next occurrence of  $*$ . Note that there is no space between the asterisk and the parenthesis.

It is permissible to put the  $\langle factor \rangle$  in curly braces. This can be used whenever it is unclear where the  $\langle factor \rangle$  would end.

Here are some examples of coordinate specifications that consist of exactly one  $\langle factor \rangle$  and one  $\langle coordinate \rangle$ :

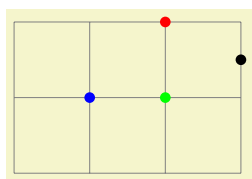

```
\begin{tikzpicture}
  \draw [help lines] (0,0) grid (3,2);

  \fill [red] ($2*(1,1)$) circle (2pt);
  \fill [green] (${1+1}*(1,.5)$) circle (2pt);
  \fill [blue] ($\cos(0)*\sin(90)*(1,1)$) circle (2pt);
  \fill [black] (${3*(4-3)}*(1,0.5)$) circle (2pt);
\end{tikzpicture}
```

### 13.5.3 The Syntax of Partway Modifiers

A  $\langle coordinate \rangle$  can be followed by different  $\langle modifiers \rangle$ . The first kind of modifier is the *partway modifier*. The syntax (which is loosely inspired by Uwe Kern's `xcolor` package) is the following:

$\langle coordinate \rangle!$ *number* $!$  $\langle angle \rangle:$ *second coordinate*

One could write for instance

```
(1,2)!.75!(3,4)
```

The meaning of this is: “Use the coordinate that is three quarters on the way from  $(1,2)$  to  $(3,4)$ .” In general,  $\langle coordinate x \rangle!$ *number* $!$  $\langle coordinate y \rangle$  yields the coordinate  $(1 - \langle number \rangle)\langle coordinate x \rangle + \langle number \rangle\langle coordinate y \rangle$ . Note that this is a bit different from the way the  $\langle number \rangle$  is interpreted in the `xcolor` package: First, you use a factor between 0 and 1, not a percentage, and, second, as the  $\langle number \rangle$  approaches 1, we approach the second coordinate, not the first. It is permissible to use  $\langle numbers \rangle$  that are smaller than 0 or larger than 1. The  $\langle number \rangle$  is evaluated using the `\pgfmathparse` command and, thus, it can involve complicated computations.

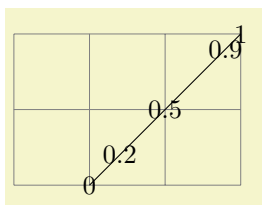

```
\begin{tikzpicture}
  \draw [help lines] (0,0) grid (3,2);

  \draw (1,0) -- (3,2);

  \foreach \i in {0,0.2,0.5,0.9,1}
    \node at ($(1,0)!\i!(3,2)$) {\i};
\end{tikzpicture}
```

The  $\langle second coordinate \rangle$  may be prefixed by an  $\langle angle \rangle$ , separated with a colon, as in  $(1,1)!.5!60:(2,2)$ . The general meaning of  $\langle a \rangle!$ *factor* $!$  $\langle angle \rangle:$  $\langle b \rangle$  is “First, consider the line from  $\langle a \rangle$  to  $\langle b \rangle$ . Then rotate this line by  $\langle angle \rangle$  around the point  $\langle a \rangle$ . Then the two endpoints of this line will be  $\langle a \rangle$  and some point  $\langle c \rangle$ . Use this point  $\langle c \rangle$  for the subsequent computation, namely the partway computation.”

Here are two examples:

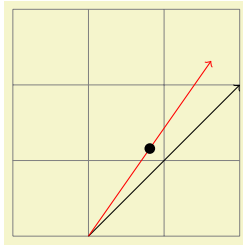

```
\begin{tikzpicture}
\draw [help lines] (0,0) grid (3,3);

\coordinate (a) at (1,0);
\coordinate (b) at (3,2);

\draw[->] (a) -- (b);

\coordinate (c) at ($ (a)!10:(b) $);

\draw[->,red] (a) -- (c);

\fill ($ (a)!5!10:(b) $) circle (2pt);
\end{tikzpicture}
```

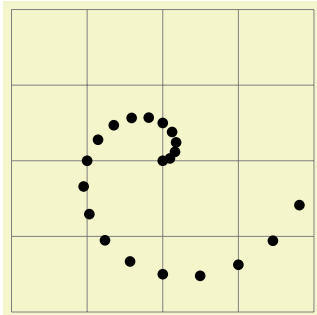

```
\begin{tikzpicture}
\draw [help lines] (0,0) grid (4,4);

\foreach \i in {0,0.1,...,2}
\fill ($(2,2)!\i!\i*180:(3,2)$) circle (2pt);
\end{tikzpicture}
```

You can repeatedly apply modifiers. That is, after any modifier you can add another (possibly different) modifier.

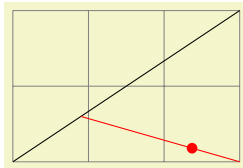

```
\begin{tikzpicture}
\draw [help lines] (0,0) grid (3,2);

\draw (0,0) -- (3,2);
\draw[red] ($(0,0)!.3!(3,2)$) -- (3,0);
\fill[red] ($(0,0)!.3!(3,2)!.7!(3,0)$) circle (2pt);
\end{tikzpicture}
```

### 13.5.4 The Syntax of Distance Modifiers

A *distance modifier* has nearly the same syntax as a partway modifier, only you use a *dimension* (something like 1cm) instead of a *factor* (something like 0.5):

$\langle coordinate \rangle!\langle dimension \rangle!\langle angle \rangle:\langle second coordinate \rangle$

When you write  $\langle a \rangle!\langle dimension \rangle!\langle b \rangle$ , this means the following: Use the point that is distanced  $\langle dimension \rangle$  from  $\langle a \rangle$  on the straight line from  $\langle a \rangle$  to  $\langle b \rangle$ . Here is an example:

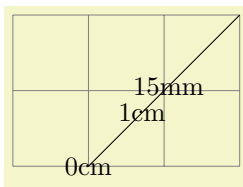

```
\begin{tikzpicture}
\draw [help lines] (0,0) grid (3,2);

\draw (1,0) -- (3,2);

\foreach \i in {0cm,1cm,15mm}
\node at ($(1,0)!\i!(3,2)$) {\i};
\end{tikzpicture}
```

As before, if you use a *angle*, the *second coordinate* is rotated by this much around the *coordinate* before it is used.

The combination of an *angle* of 90 degrees with a distance can be used to “offset” a point relative to a line. Suppose, for instance, that you have computed a point (c) that lies somewhere on a line from (a) to (b) and you now wish to offset this point by 1cm so that the distance from this offset point to the line is 1cm. This can be achieved as follows:

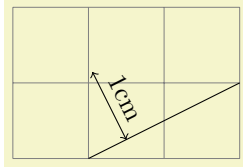

```

\begin{tikzpicture}
  \draw [help lines] (0,0) grid (3,2);

  \coordinate (a) at (1,0);
  \coordinate (b) at (3,1);

  \draw (a) -- (b);

  \coordinate (c) at ($ (a)!.25!(b) $);
  \coordinate (d) at ($ (c)!1cm!90:(b) $);

  \draw [<->] (c) -- (d) node [sloped,midway,above] {1cm};
\end{tikzpicture}

```

### 13.5.5 The Syntax of Projection Modifiers

The projection modifier is also similar to the above modifiers: It also gives a point on a line from the  $\langle coordinate \rangle$  to the  $\langle second coordinate \rangle$ . However, the  $\langle number \rangle$  or  $\langle dimension \rangle$  is replaced by a  $\langle projection coordinate \rangle$ :

$\langle coordinate \rangle ! \langle projection coordinate \rangle ! \langle angle \rangle : \langle second coordinate \rangle$

Here is an example:

```
(1,2)!(0,5)!(3,4)
```

The effect is the following: We project the  $\langle projection coordinate \rangle$  orthogonally onto to the line from  $\langle coordinate \rangle$  to  $\langle second coordinate \rangle$ . This makes it easy to compute projected points:

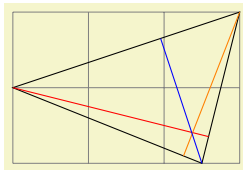

```

\begin{tikzpicture}
  \draw [help lines] (0,0) grid (3,2);

  \coordinate (a) at (0,1);
  \coordinate (b) at (3,2);
  \coordinate (c) at (2.5,0);

  \draw (a) -- (b) -- (c) -- cycle;

  \draw [red] (a) -- ($ (b)!(a)!(c) $);
  \draw [orange] (b) -- ($ (a)!(b)!(c) $);
  \draw [blue] (c) -- ($ (a)!(c)!(b) $);
\end{tikzpicture}

```



## 14 Syntax for Path Specifications

A *path* is a series of straight and curved line segments. It is specified following a `\path` command and the specification must follow a special syntax, which is described in the subsections of the present section.

`\path` $\langle specification \rangle$ ;

This command is available only inside a `{tikzpicture}` environment.

The  $\langle specification \rangle$  is a long stream of *path operations*. Most of these path operations tell TikZ how the path is build. For example, when you write `--(0,0)`, you use a *line-to operation* and it means “continue the path from wherever you are to the origin.”

At any point where TikZ expects a path operation, you can also give some graphic options, which is a list of options in brackets, such as `[rounded corners]`. These options can have different effects:

1. Some options take “immediate” effect and apply to all subsequent path operations on the path. For example, the `rounded corners` option will round all following corners, but not the corners “before” and if the `sharp corners` is given later on the path (in a new set of brackets), the rounding effect will end.



```
\tikz \draw (0,0) -- (1,1)
      [rounded corners] -- (2,0) -- (3,1)
      [sharp corners] -- (3,0) -- (2,1);
```

Another example are the transformation options, which also apply only to subsequent coordinates.

2. The options that have immediate effect can be “scoped” by putting part of a path in curly braces. For example, the above example could also be written as follows:



```
\tikz \draw (0,0) -- (1,1)
      {[rounded corners] -- (2,0) -- (3,1)}
      -- (3,0) -- (2,1);
```

3. Some options only apply to the path as a whole. For example, the `color=` option for determining the color used for, say, drawing the path always applies to all parts of the path. If several different colors are given for different parts of the path, only the last one (on the outermost scope) “wins”:



```
\tikz \draw (0,0) -- (1,1)
      [color=red] -- (2,0) -- (3,1)
      [color=blue] -- (3,0) -- (2,1);
```

Most options are of this type. In the above example, we would have had to “split up” the path into several `\path` commands:

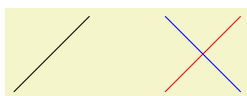

```
\tikz{\draw (0,0) -- (1,1);
      \draw [color=red] (2,0) -- (3,1);
      \draw [color=blue] (3,0) -- (2,1);}
```

By default, the `\path` command does “nothing” with the path, it just “throws it away.” Thus, if you write `\path(0,0)--(1,1);`, nothing is drawn in your picture. The only effect is that the area occupied by the picture is (possibly) enlarged so that the path fits inside the area. To actually “do” something with the path, an option like `draw` or `fill` must be given somewhere on the path. Commands like `\draw` do this implicitly.

Finally, it is also possible to give *node specifications* on a path. Such specifications can come at different locations, but they are always allowed when a normal path operation could follow. A node specification starts with `node`. Basically, the effect is to typeset the node’s text as normal  $\text{\TeX}$  text and to place it at the “current location” on the path. The details are explained in Section 16.

Note, however, that the nodes are *not* part of the path in any way. Rather, after everything has been done with the path what is specified by the path options (like filling and drawing the path due to a `fill` and a `draw` option somewhere in the  $\langle specification \rangle$ ), the nodes are added in a post-processing step.

The following style influences scopes:

**/tikz/every path**

(style, initially empty)

This style is installed at the beginning of every path. This can be useful for (temporarily) adding, say, the `draw` option to everything in a scope.



```
\begin{tikzpicture}
  [fill=examplefill,           % only sets the color
  every path/.style={draw}] % all paths are drawn
  \fill (0,0) rectangle +(1,1);
  \shade (2,0) rectangle +(1,1);
\end{tikzpicture}
```

**/tikz/insert path=*⟨path⟩***

(no default)

This key can be used inside an option to add something to the current path. This is mostly useful for defining styles that create graphic contents. This option should be used with care, for instance it should not be used as an argument of, say, a `node`. In the following example, we use a style to add little circles to a path.

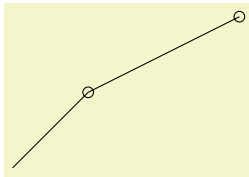

```
\tikz [c/.style={insert path={circle[radius=2pt]}}]
  \draw (0,0) -- (1,1) [c] -- (3,2) [c];
```

The effect is the same as of `(0,0) -- (1,1) circle[radius=2pt] -- (3,2) circle[radius=2pt]`.

The following options are for experts only:

**/tikz/append after command=*⟨path⟩***

(no default)

Some of the path commands described in the following sections take optional arguments. For these commands, when you use this key inside these options, the *⟨path⟩* will be inserted *after* the path command is done. For instance, when you give this command in the option list of a `node`, the *⟨path⟩* will be added after the node. This is used by, for instance, the `label` option to allow you to specify a label in the option list of a `node`, but have this `label` cause a `node` to be added after another `node`.

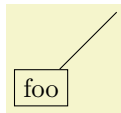

```
\tikz \draw node [append after command={(foo)--(1,1)},draw] (foo){foo};
```

If this key is called multiple times, the effects accumulate, that is, all of the paths are added in the order to keys were found.

**/tikz/prefix after command=*⟨path⟩***

(no default)

Works like `append after command`, only the accumulation order is inverse: The *⟨path⟩* is added before any earlier paths added using either `append after command` or `prefix after command`.

## 14.1 The Move-To Operation

The perhaps simplest operation is the move-to operation, which is specified by just giving a coordinate where a path operation is expected.

```
\path ... ⟨coordinate⟩ ... ;
```

The move-to operation normally starts a path at a certain point. This does not cause a line segment to be created, but it specifies the starting point of the next segment. If a path is already under construction, that is, if several segments have already been created, a move-to operation will start a new part of the path that is not connected to any of the previous segments.

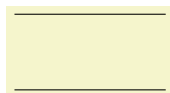

```
\begin{tikzpicture}
  \draw (0,0) --(2,0) (0,1) --(2,1);
\end{tikzpicture}
```

In the specification `(0,0) --(2,0) (0,1) --(2,1)` two move-to operations are specified: `(0,0)` and `(0,1)`. The other two operations, namely `--(2,0)` and `--(2,1)` are line-to operations, described next.

## 14.2 The Line-To Operation

### 14.2.1 Straight Lines

`\path ... --<coordinate> ... ;`

The line-to operation extends the current path from the current point in a straight line to the given coordinate. The “current point” is the endpoint of the previous drawing operation or the point specified by a prior move-to operation.

You use two minus signs followed by a coordinate in round brackets. You can add spaces before and after the `--`.

When a line-to operation is used and some path segment has just been constructed, for example by another line-to operation, the two line segments become joined. This means that if they are drawn, the point where they meet is “joined” smoothly. To appreciate the difference, consider the following two examples: In the left example, the path consists of two path segments that are not joined, but that happen to share a point, while in the right example a smooth join is shown.



```
\begin{tikzpicture}[line width=10pt]
\draw (0,0) --(1,1) (1,1) --(2,0);
\draw (3,0) -- (4,1) -- (5,0);
\useasboundingbox (0,1.5); % make bounding box higher
\end{tikzpicture}
```

### 14.2.2 Horizontal and Vertical Lines

Sometimes you want to connect two points via straight lines that are only horizontal and vertical. For this, you can use two path construction operations.

`\path ... -|<coordinate> ... ;`

This operation means “first horizontal, then vertical.”

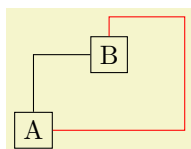

```
\begin{tikzpicture}
\draw (0,0) node(a) [draw] {A} (1,1) node(b) [draw] {B};
\draw (a.north) |- (b.west);
\draw[color=red] (a.east) -| (2,1.5) -| (b.north);
\end{tikzpicture}
```

`\path ... |-<coordinate> ... ;`

This operations means “first vertical, then horizontal.”

## 14.3 The Curve-To Operation

The curve-to operation allows you to extend a path using a Bézier curve.

`\path ... ..controls<c>and<d>..<y> ... ;`

This operation extends the current path from the current point, let us call it  $x$ , via a curve to a the current point  $y$ . The curve is a cubic Bézier curve. For such a curve, apart from  $y$ , you also specify two control points  $c$  and  $d$ . The idea is that the curve starts at  $x$ , “heading” in the direction of  $c$ . Mathematically spoken, the tangent of the curve at  $x$  goes through  $c$ . Similarly, the curve ends at  $y$ , “coming from” the other control point,  $d$ . The larger the distance between  $x$  and  $c$  and between  $d$  and  $y$ , the larger the curve will be.

If the “`and<d>`” part is not given,  $d$  is assumed to be equal to  $c$ .

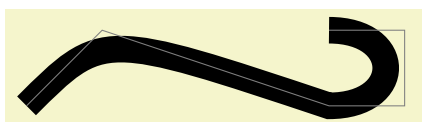

```

\begin{tikzpicture}
  \draw[line width=10pt] (0,0) .. controls (1,1) .. (4,0)
    .. controls (5,0) and (5,1) .. (4,1);
  \draw[color=gray] (0,0) -- (1,1) -- (4,0) -- (5,0) -- (5,1) -- (4,1);
\end{tikzpicture}

```

As with the line-to operation, it makes a difference whether two curves are joined because they resulted from consecutive curve-to or line-to operations, or whether they just happen to have the same ending:

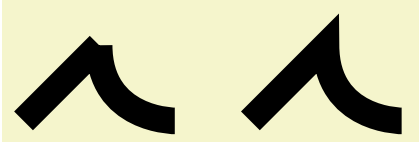

```

\begin{tikzpicture}[line width=10pt]
  \draw (0,0) -- (1,1) (1,1) .. controls (1,0) and (2,0) .. (2,0);
  \draw (3,0) -- (4,1) .. controls (4,0) and (5,0) .. (5,0);
  \useasboundingbox (0,1.5); % make bounding box higher
\end{tikzpicture}

```

## 14.4 The Cycle Operation

```
\path ... --cycle ...;
```

This operation adds a straight line from the current point to the last point specified by a move-to operation. Note that this need not be the beginning of the path. Furthermore, a smooth join is created between the first segment created after the last move-to operation and the straight line appended by the cycle operation.

Consider the following example. In the left example, two triangles are created using three straight lines, but they are not joined at the ends. In the second example cycle operations are used.

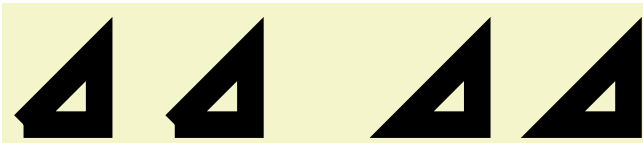

```

\begin{tikzpicture}[line width=10pt]
  \draw (0,0) -- (1,1) -- (1,0) -- (0,0) (2,0) -- (3,1) -- (3,0) -- (2,0);
  \draw (5,0) -- (6,1) -- (6,0) -- cycle (7,0) -- (8,1) -- (8,0) -- cycle;
  \useasboundingbox (0,1.5); % make bounding box higher
\end{tikzpicture}

```

## 14.5 The Rectangle Operation

A rectangle can obviously be created using four straight lines and a cycle operation. However, since rectangles are needed so often, a special syntax is available for them.

```
\path ... rectangle<corner> ...;
```

When this operation is used, one corner will be the current point, another corner is given by *<corner>*, which becomes the new current point.

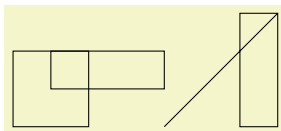

```

\begin{tikzpicture}
  \draw (0,0) rectangle (1,1);
  \draw (.5,1) rectangle (2,0.5) (3,0) rectangle (3.5,1.5) -- (2,0);
\end{tikzpicture}

```

## 14.6 Rounding Corners

All of the path construction operations mentioned up to now are influenced by the following option:

`/tikz/rounded corners=<inset>` (default 4pt)

When this option is in force, all corners (places where a line is continued either via line-to or a curve-to operation) are replaced by little arcs so that the corner becomes smooth.



```
\tikz \draw [rounded corners] (0,0) -- (1,1)
-- (2,0) .. controls (3,1) .. (4,0);
```

The `<inset>` describes how big the corner is. Note that the `<inset>` is *not* scaled along if you use a scaling option like `scale=2`.

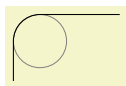

```
\begin{tikzpicture}
\draw[color=gray,very thin] (10pt,15pt) circle[radius=10pt];
\draw[rounded corners=10pt] (0,0) -- (0pt,25pt) -- (40pt,25pt);
\end{tikzpicture}
```

You can switch the rounded corners on and off “in the middle of path” and different corners in the same path can have different corner radii:

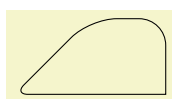

```
\begin{tikzpicture}
\draw (0,0) [rounded corners=10pt] -- (1,1) -- (2,1)
[sharp corners] -- (2,0)
[rounded corners=5pt] -- cycle;
\end{tikzpicture}
```

Here is a rectangle with rounded corners:



```
\tikz \draw[rounded corners=1ex] (0,0) rectangle (20pt,2ex);
```

You should be aware, that there are several pitfalls when using this option. First, the rounded corner will only be an arc (part of a circle) if the angle is  $90^\circ$ . In other cases, the rounded corner will still be round, but “not as nice.”

Second, if there are very short line segments in a path, the “rounding” may cause inadvertent effects. In such case it may be necessary to temporarily switch off the rounding using `sharp corners`.

`/tikz/sharp corners` (no value)

This options switches off any rounding on subsequent corners of the path.

## 14.7 The Circle and Ellipse Operations

Circles and ellipses are common path elements for which there is a special path operation.

`\path ... circle[<options>] ... ;`

This command adds a circle to the current path where the center of the circle is the current point by default, but you can use the `at` option to change this. The new current point of the path will be (typically just remain) the center of the circle.

The radius of the circle is specified using the following options:

`/tikz/x radius=<value>` (no default)

Sets the horizontal radius of the circle (which, when this value is different from the vertical radius, is actually an ellipse). The `<value>` may either be a dimension or a dimensionless number. In the latter case, the number is interpreted in the  $xy$ -coordinate system (if the  $x$ -unit is set to, say, 2cm, then `x radius=3` will have the same effect as `x radius=6cm`).

`/tikz/y radius=<value>` (no default)

Works like the `x radius`.

`/tikz/radius=<value>` (no default)

Sets the `x radius` and `y radius` simultaneously.

`/tikz/at=<coordinate>` (no default)

If this option is explicitly set inside the `<options>` (or indirectly via the `every circle` style), the `<coordinate>` is used as the center of the circle instead of the current point. Setting `at` to some value in an enclosing scope has no effect.

The `<options>` may also contain additional options like, say, a `rotate` or `scale`, that will only have an effect on the circle.

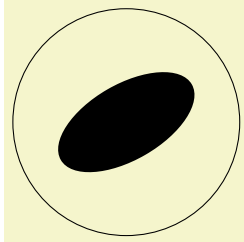

```
\begin{tikzpicture}
\draw (1,0) circle [radius=1.5];
\fill (1,0) circle [x radius=1cm, y radius=5mm, rotate=30];
\end{tikzpicture}
```

It is possible to set the `radius` also in some enclosing scope, in this case the options can be left out (but see the note below on what may follow:

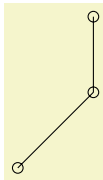

```
\begin{tikzpicture}[radius=2pt]
\draw (0,0) circle -- (1,1) circle -- ++(0,1) circle;
\end{tikzpicture}
```

The following style is used with every circle:

`/tikz/every circle` (style, no value)

You can use this key to setup, say, a default radius for every circle. The key will also be used with the `ellipse` operation.

In case you feel that the names `radius` and `x radius` are too long for your taste, you can easily create shorter aliases:

```
\tikzset{r/.style={radius=#1},rx/.style={x radius=#1},ry/.style={y radius=#1}}
```

You can then say `circle [r=1cm]` or `circle [rx=1,ry=1.5]`. The reason TikZ uses the longer names by default is that it encourages people to write more readable code.

*Note:* There also exists an older syntax for circles, where the radius of the circle is given in parentheses right after the `circle` command as in `circle (1pt)`. Although this syntax is a bit more succinct, it is harder to understand for readers of the code and the use of parentheses for something other than a coordinate is ill-chosen.

TikZ will use the following rule to determine whether the old or the normal syntax is used: If `circle` is directly followed by something that (expands to) an opening parenthesis, then the old syntax is used and inside these following parentheses there must be a single number or dimension representing a radius. In all other cases the new syntax is used.

`\path ... ellipse[<options>] ... ;`

This command has exactly the same effect as `circle`. The older syntax for this command is `ellipse (<x radius> and <y radius>)`. As for the `circle` command, this syntax is not as good as the standard syntax.

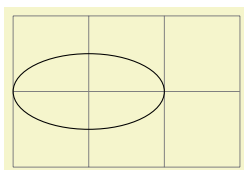

```
\begin{tikzpicture}
\draw [help lines] (0,0) grid (3,2);
\draw (1,1) ellipse [x radius=1cm,y radius=.5cm];
\end{tikzpicture}
```

## 14.8 The Arc Operation

The *arc operation* allows you to add an arc to the current path.

```
\path ... arc[options] ...;
```

The `arc` operation adds a part of an ellipse to the current path. The radii of the ellipse are given by the values of `x radius` and `y radius`, which should be set in the `options`. The arc will start at the current point and will end at the end of the arc. The arc will start and end at angles computed from the three keys `start angle`, `end angle`, and `delta angle`. Normally, the first two keys specify the start and end angle. However, in case one of them is empty, it is computed from the other key plus or minus the `delta angle`. In detail, if `end angle` is empty, it is set to the start angle plus the delta angle. If the start angle is missing, it is set to the end angle minus the delta angle. If all three keys are set, the delta angle is ignored.

```
/tikz/start angle=degrees (no default)
```

Sets the start angle.

```
/tikz/end angle=degrees (no default)
```

Sets the end angle.

```
/tikz/delta angle=degrees (no default)
```

Sets the delta angle.

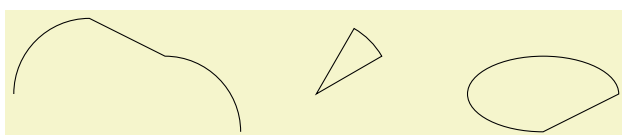

```
\begin{tikzpicture}[radius=1cm]
  \draw (0,0) arc[start angle=180, end angle=90]
    -- (2,.5) arc[start angle=90, delta angle=-90];
  \draw (4,0) -- +(30:1cm)
    arc [start angle=30, delta angle=30] -- cycle;
  \draw (8,0) arc [start angle=0, end angle=270,
    x radius=1cm, y radius=5mm] -- cycle;
\end{tikzpicture}
```

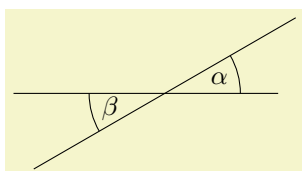

```
\begin{tikzpicture}[radius=1cm,delta angle=30]
  \draw (-1,0) -- +(3.5,0);
  \draw (1,0) ++(210:2cm) -- +(30:4cm);
  \draw (1,0) +(0:1cm) arc [start angle=0];
  \draw (1,0) +(180:1cm) arc [start angle=180];
  \path (1,0) ++(15:.75cm) node{\alpha};
  \path (1,0) ++(15:-.75cm) node{\beta};
\end{tikzpicture}
```

There also exists a shorter syntax for the arc operation, namely `arc` begin directly followed by `(start angle):(end angle):(radius)`. However, this syntax is harder to read, so the normal syntax should be preferred in general.

## 14.9 The Grid Operation

You can add a grid to the current path using the `grid path` operation.

```
\path ... grid[options]corner ...;
```

This operations adds a grid filling a rectangle whose two corners are given by `corner` and by the previous coordinate. Thus, the typical way in which a grid is drawn is `\draw (1,1) grid (3,3)`; which yields a grid filling the rectangle whose corners are at (1,1) and (3,3). All coordinate transformations apply to the grid.

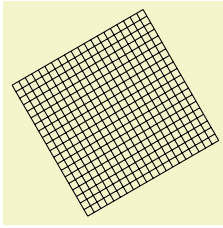

```
\tikz[rotate=30] \draw[step=1mm] (0,0) grid (2,2);
```

The  $\langle options \rangle$ , which are local to the `grid` operation, can be used to influence the appearance of the grid. The stepping of the grid is governed by the following options:

**`/tikz/step`**= $\langle number\ or\ dimension\ or\ coordinate \rangle$  (no default, initially 1cm)

Sets the stepping in both the  $x$  and  $y$ -direction. If a dimension is provided, this is used directly. If a number is provided, this number is interpreted in the  $xy$ -coordinate system. For example, if you provide the number 2, then the  $x$ -step is twice the  $x$ -vector and the  $y$ -step is twice the  $y$ -vector set by the `x=` and `y=` options. Finally, if you provide a coordinate, then the  $x$ -part of this coordinate will be used as the  $x$ -step and the  $y$ -part will be used as the  $y$ -coordinate.

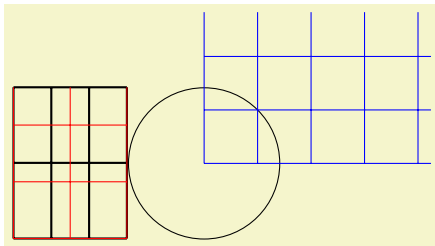

```
\begin{tikzpicture}[x=.5cm]
  \draw[thick] (0,0) grid [step=1] (3,2);
  \draw[red] (0,0) grid [step=.75cm] (3,2);
\end{tikzpicture}
\begin{tikzpicture}
  \draw (0,0) circle [radius=1];
  \draw[blue] (0,0) grid [step=(45:1)] (3,2);
\end{tikzpicture}
```

A complication arises when the  $x$ - and/or  $y$ -vector do not point along the axes. Because of this, the actual rule for computing the  $x$ -step and the  $y$ -step is the following: As the  $x$ - and  $y$ -steps we use the  $x$ - and  $y$ -components or the following two vectors: The first vector is either  $(\langle x\text{-grid-step-number} \rangle, 0)$  or  $(\langle x\text{-grid-step-dimension} \rangle, 0pt)$ , the second vector is  $(0, \langle y\text{-grid-step-number} \rangle)$  or  $(0pt, \langle x\text{-grid-step-dimension} \rangle)$ .

**`/tikz/xstep`**= $\langle dimension\ or\ number \rangle$  (no default, initially 1cm)

Sets the stepping in the  $x$ -direction.

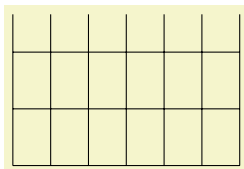

```
\tikz \draw (0,0) grid [xstep=.5,ystep=.75] (3,2);
```

**`/tikz/ystep`**= $\langle dimension\ or\ number \rangle$  (no default, initially 1cm)

Sets the stepping in the  $y$ -direction.

It is important to note that the grid is always “phased” such that it contains the point  $(0, 0)$  if that point happens to be inside the rectangle. Thus, the grid does *not* always have an intersection at the corner points; this occurs only if the corner points are multiples of the stepping. Note that due to rounding errors, the “last” lines of a grid may be omitted. In this case, you have to add an epsilon to the corner points.

The following style is useful for drawing grids:



`/tikz/help lines`

(style, initially `line width=0.2pt,gray`)

This style makes lines “subdued” by using thin gray lines for them. However, this style is not installed automatically and you have to say for example:

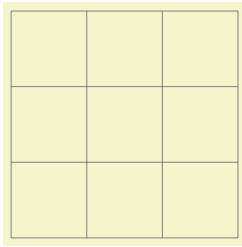

```
\tikz \draw[help lines] (0,0) grid (3,3);
```

## 14.10 The Parabola Operation

The `parabola` path operation continues the current path with a parabola. A parabola is a (shifted and scaled) curve defined by the equation  $f(x) = x^2$  and looks like this:  $\cup$ .

```
\path ... parabola[<options>] bend <bend coordinate> <coordinate> ... ;
```

This operation adds a parabola through the current point and the given *<coordinate>*. If the `bend` is given, it specifies where the bend should go; the *<options>* can also be used to specify where the bend is. By default, the bend is at the old current point.

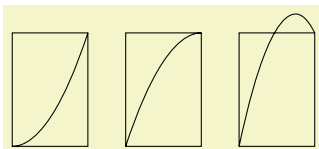

```
\begin{tikzpicture}
\draw (0,0) rectangle (1,1.5)
      (0,0) parabola (1,1.5);
\draw[xshift=1.5cm] (0,0) rectangle (1,1.5)
      (0,0) parabola[bend at end] (1,1.5);
\draw[xshift=3cm] (0,0) rectangle (1,1.5)
      (0,0) parabola bend (.75,1.75) (1,1.5);
\end{tikzpicture}
```

The following options influence parabolas:

`/tikz/bend=<coordinate>`

(no default)

Has the same effect as saying `bend<coordinate>` outside the *<options>*. The option specifies that the bend of the parabola should be at the given *<coordinate>*. You have to take care yourself that the bend position is a “valid” position; which means that if there is no parabola of the form  $f(x) = ax^2 + bx + c$  that goes through the old current point, the given bend, and the new current point, the result will not be a parabola.

There is one special property of the *<coordinate>*: When a relative coordinate is given like  $+(0,0)$ , the position relative to which this coordinate is “flexible.” More precisely, this position lies somewhere on a line from the old current point to the new current point. The exact position depends on the next option.

`/tikz/bend pos=<fraction>`

(no default)

Specifies where the “previous” point is relative to which the bend is calculated. The previous point will be at the *<fraction>*th part of the line from the old current point to the new current point.

The idea is the following: If you say `bend pos=0` and `bend +(0,0)`, the bend will be at the old current point. If you say `bend pos=1` and `bend +(0,0)`, the bend will be at the new current point. If you say `bend pos=0.5` and `bend +(0,2cm)` the bend will be 2cm above the middle of the line between the start and end point. This is most useful in situations such as the following:

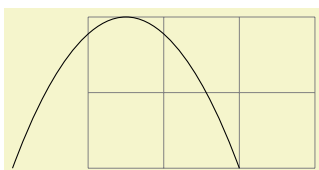

```
\begin{tikzpicture}
\draw[help lines] (0,0) grid (3,2);
\draw (-1,0) parabola[bend pos=0.5] bend +(0,2) +(3,0);
\end{tikzpicture}
```

In the above example, the `bend +(0,2)` essentially means “a parabola that is 2cm high” and `+(3,0)` means “and 3cm wide.” Since this situation arises often, there is a special shortcut option:

`/tikz/parabola height=<dimension>` (no default)

This option has the same effect as `[bend pos=0.5,bend={+(0pt,<dimension>)}]`.

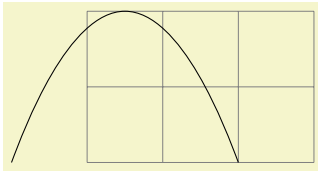

```
\begin{tikzpicture}
\draw[help lines] (0,0) grid (3,2);
\draw (-1,0) parabola[parabola height=2cm] +(3,0);
\end{tikzpicture}
```

The following styles are useful shortcuts:

`/tikz/bend at start` (style, no value)

This places the bend at the start of a parabola. It is a shortcut for the following options: `bend pos=0,bend={+(0,0)}`.

`/tikz/bend at end` (style, no value)

This places the bend at the end of a parabola.

## 14.11 The Sine and Cosine Operation

The `sin` and `cos` operations are similar to the `parabola` operation. They, too, can be used to draw (parts of) a sine or cosine curve.

`\path ... sin<coordinate> ...;`

The effect of `sin` is to draw a scaled and shifted version of a sine curve in the interval  $[0, \pi/2]$ . The scaling and shifting is done in such a way that the start of the sine curve in the interval is at the old current point and that the end of the curve in the interval is at `<coordinate>`. Here is an example that should clarify this:

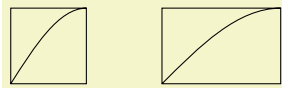

```
\tikz \draw (0,0) rectangle (1,1) (0,0) sin (1,1)
(2,0) rectangle +(1.57,1) (2,0) sin +(1.57,1);
```

`\path ... cos<coordinate> ...;`

This operation works similarly, only a cosine in the interval  $[0, \pi/2]$  is drawn. By correctly alternating `sin` and `cos` operations, you can create a complete sine or cosine curve:

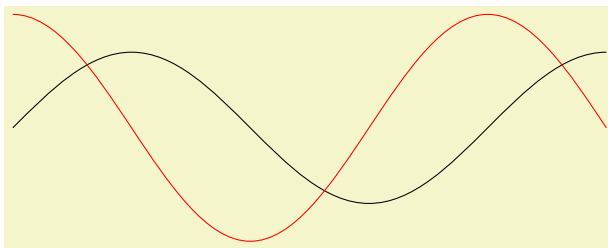

```
\begin{tikzpicture}[xscale=1.57]
\draw (0,0) sin (1,1) cos (2,0) sin (3,-1) cos (4,0) sin (5,1);
\draw[color=red] (0,1.5) cos (1,0) sin (2,-1.5) cos (3,0) sin (4,1.5) cos (5,0);
\end{tikzpicture}
```

Note that there is no way to (conveniently) draw an interval on a sine or cosine curve whose end points are not multiples of  $\pi/2$ .

## 14.12 The SVG Operation

The `svg` operation can be used to extend the current path by a path given in the SVG path data syntax. This syntax is described in detail in Section 8.3 of the SVG 1.1 specification, please consult this specification for details.

```
\path ... svg[options]"path data" ...;
```

This operation adds the path specified in the  $\langle path data \rangle$  in SVG 1.1 PATH DATA syntax to the current path. Unlike the SVG-specification, it is permissible that the path data does not start with a moveto command (m or M), in which case the last point of the current path is used as start point. The optional  $\langle options \rangle$  apply locally to this path operation, typically you will use them to setup, say, some transformations.

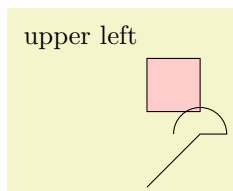

```
\begin{tikzpicture}
  \filldraw [fill=red!20] (0,1) svg[scale=2] "h 10 v 10 h -10"
  node [above left] {upper left} -- cycle;

  \draw svg "M 0 0 L 20 20 h 10 a 10 10 0 0 0 -20 0";
\end{tikzpicture}
```

An SVG coordinate like 10 20 is always interpreted as (10pt,20pt), so the basic unit is always points (pt). The  $xy$ -coordinate system is not used. However, you can use scaling to (locally) change the basic unit. For instance, `svg[scale=1cm]` (yes, this works, although some rather evil magic is involved) will cause 1cm to be the basic unit.

*Warning:* The arc operations (a and A) are not numerically stable. This means that they will be quite imprecise, except when the angle is a multiple of  $90^\circ$  (as is, fortunately, most often the case).

### 14.13 The Plot Operation

The `plot` operation can be used to append a line or curve to the path that goes through a large number of coordinates. These coordinates are either given in a simple list of coordinates, read from some file, or they are computed on the fly.

Since the syntax and the behaviour of this command are a bit complex, they are described in the separated Section 19.

### 14.14 The To Path Operation

The `to` operation is used to add a user-defined path from the previous coordinate to the following coordinate. When you write (a) to (b), a straight line is added from a to b, exactly as if you had written (a) -- (b). However, if you write (a) to [out=135,in=45] (b) a curve is added to the path, which leaves at an angle of  $135^\circ$  at a and arrives at an angle of  $45^\circ$  at b. This is because the options `in` and `out` trigger a special path to be used instead of the straight line.

```
\path ... to[options] nodes (coordinate) ...;
```

This path operation inserts the path current set via the `to path` option at the current position. The  $\langle options \rangle$  can be used to modify (perhaps implicitly) the `to path` and to setup how the path will be rendered.

Before the `to path` is inserted, a number of macros are setup that can “help” the `to path`. These are `\tikztostart`, `\tikztotarget`, and `\tikztonodes`; they are explained in the following.

**Start and Target Coordinates.** The `to` operation is always followed by a  $\langle coordinate \rangle$ , called the target coordinate. The macro `\tikztotarget` is set to this coordinate (without the parentheses). There is also a *start coordinate*, which is the coordinate preceding the `to` operation. This coordinate can be accessed via the macro `\tikztostart`. In the following example, for the first `to`, the macro `\tikztostart` is 0pt,0pt and the `\tikztotarget` is 0,2. For the second `to`, the macro `\tikztostart` is 10pt,10pt and `\tikztotarget` is a.

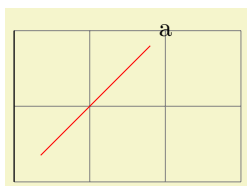

```
\begin{tikzpicture}
  \draw[help lines] (0,0) grid (3,2);

  \draw (0,0) to (0,2);
  \node (a) at (2,2) {a};
  \draw[red] (10pt,10pt) to (a);
\end{tikzpicture}
```

**Nodes on tos.** It is possible to add nodes to the paths constructed by a `to` operation. To do so, you specify the nodes between the `to` keyword and the coordinate (if there are options to the `to` operation,

these come first). The effect of (a) `to node {x}` (b) (typically) is the same as if you had written (a) `-- node {x}` (b), namely that the node is placed on the to. This can be used to add labels to tos:

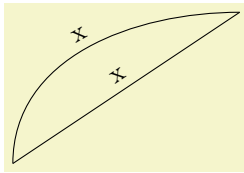

```
\begin{tikzpicture}
  \draw (0,0) to node [sloped,above] {x} (3,2);

  \draw (0,0) to[out=90,in=180] node [sloped,above] {x} (3,2);
\end{tikzpicture}
```

**Styles for to-paths.** In addition to the  $\langle options \rangle$  given after the `to` operation, the following style is also set at the beginning of the `to` path:

`/tikz/every to` (style, initially empty)

This style is installed at the beginning of every `to`.

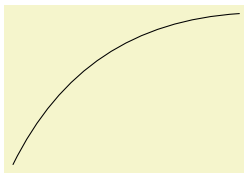

```
\tikz[every to/.style={bend left}]
\draw (0,0) to (3,2);
```

**Options.** The  $\langle options \rangle$  given with the `to` allow you to influence the appearance of the `to` path. Mostly, these options are used to change the `to` path. This can be used to change the path from a straight line to, say, a curve.

The path used is set using the following option:

`/tikz/to path= $\langle path \rangle$`  (no default)

Whenever an `to` operation is used, the  $\langle path \rangle$  is inserted. More precisely, the following path is added:

```
{[every to, $\langle options \rangle$ ]  $\langle path \rangle$ }
```

The  $\langle options \rangle$  are the options given to the `to` operation, the  $\langle path \rangle$  is the path set by this option `to path`.

Inside the  $\langle path \rangle$ , different macros are used to reference the from- and to-coordinates. In detail, these are:

- `\tikztostart` will expand to the from-coordinate (without the parentheses).
- `\tikztotarget` will expand to the to-coordinate.
- `\tikztonodes` will expand to the nodes between the `to` operation and the coordinate. Furthermore, these nodes will have the `pos` option set implicitly.

Let us have a look at a simple example. The standard straight line for an `to` is achieved by the following  $\langle path \rangle$ :

```
-- (\tikztotarget) \tikztonodes
```

Indeed, this is the default setting for the path. When we write (a) `to` (b), the  $\langle path \rangle$  will expand to (a) `--` (b), when we write

```
(a) to[red] node {x} (b)
```

the  $\langle path \rangle$  will expand to

```
(a) -- (b) node[pos] {x}
```

It is not possible to specify the path

```
-- \tikztonodes (\tikztotarget)
```

since TikZ does not allow one to have a macro after `--` that expands to a node.

Now let us have a look at how we can modify the  $\langle path \rangle$  sensibly. The simplest way is to use a curve.

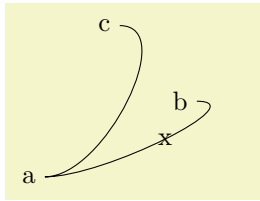

```
\begin{tikzpicture}[to path={
  .. controls +(1,0) and +(1,0) .. (\tikztotarget) \tikztonodes}]

\node (a) at (0,0) {a};
\node (b) at (2,1) {b};
\node (c) at (1,2) {c};

\draw (a) to node {x} (b)
      (a) to          (c);
\end{tikzpicture}
```

Here is another example:

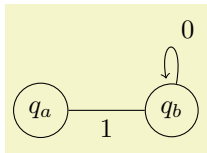

```
\tikzset{
  my loop/.style={to path={
    .. controls +(80:1) and +(100:1) .. (\tikztotarget) \tikztonodes}},
  my state/.style={circle,draw}}

\begin{tikzpicture}[shorten >=2pt]
\node [my state] (a) at (210:1) {$q_a$};
\node [my state] (b) at (330:1) {$q_b$};

\draw[->] (a) to          node[below]      {1} (b)
          to [my loop] node[above right] {0} (b);
\end{tikzpicture}
```

`/tikz/execute at begin to=code` (no default)

The *code* is executed prior to the `to`. This can be used to draw one or more additional paths or to do additional computations.

`/tikz/execute at end to=code` (no default)

Works like the previous option, only this code is executed after the `to` path has been added.

`/tikz/every to` (style, initially empty)

This style is installed at the beginning of every `to`.

There are a number of predefined `to` paths, see Section 48 for a reference.

## 14.15 The Let Operation

The *let operation* is the first of a number of path operations that do not actually extend that path, but have different, mostly local, effects.

`\path ... let(assignment) ,(assignment) ,(assignment)... in ... ;`

When this path operation is encountered, the *assignment*s are evaluated, one by one. This will store coordinate and number in special *registers* (which are local to TikZ, they have nothing to do with TeX registers). Subsequently, one can access the contents of these registers using the macros `\p`, `\x`, `\y`, and `\n`.

The first kind of permissible *assignment*s have the following form:

`\n<number register>={<formula>}`

When an assignment has this form, the *formula* is evaluated using the `\pgfmathparse` operation. The result stored in the *number register*. If the *formula* involves a dimension anywhere (as in `2*3cm/2`), then the *number register* stores the resulting dimension with a trailing `pt`. A *number register* can be named arbitrarily and is a normal TeX parameter to the `\n` macro. Possible names are `{left corner}`, but also just a single digit like `5`.

Let us call the path that follows a *let* operation its *body*. Inside the body, the `\n` macro can be used to access the register.

`\n{<number register>}`

When this macro is used on the left-hand side of an `=`-sign in a *let* operation, it has no effect and is just there for readability. When the macro is used on the right-hand side of an `=`-sign or in the body of the *let* operation, then it expands to the value stored in the *number register*. This will either be a dimensionless number like `2.0` or a dimension like `5.6pt`.

For instance, if we say `let \n1={1pt+2pt}, \n2={1+2} in ...`, then inside the `...` part the macro `\n1` will expand to `3pt` and `\n2` expands to `3`.

The second kind of *assignments* have the following form:

`\p{point register}={formula}`

Point position registers store a single point, consisting of an *x*-part and a *y*-part measured in  $\text{T}_{\text{E}}\text{X}$  points (`pt`). In particular, point registers do not store nodes or node names. Here is an example:

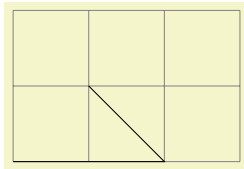

```
\begin{tikzpicture}
\draw [help lines] (0,0) grid (3,2);

\draw let \p{foo} = (1,1), \p2 = (2,0) in
(0,0) -- (\p2) -- (\p{foo});
\end{tikzpicture}
```

`\p{point register}`

When this macro is used on the left-hand side of an `=`-sign in a `let` operation, it has no effect and is just there for readability. When the macro is used on the right-hand side of an `=`-sign or in the body of the `let` operation, then it expands to the *x*-part (measured in  $\text{T}_{\text{E}}\text{X}$  points) of the coordinate stored in the *register*, followed, by a comma, followed by the *y*-part.

For instance, if we say `let \p1=(1pt,1pt+2pt) in ...`, then inside the `...` part the macro `\p1` will expand to exactly the seven characters `"1pt,3pt"`. This means that you when you write `(\p1)`, this expands to `(1pt,3pt)`, which is presumably exactly what you intended.

`\x{point register}`

This macro expands just to the *x*-part of the point register. If we say as above, as we did above, `let \p1=(1pt,1pt+2pt) in ...`, then inside the `...` part the macro `\x1` expands to `1pt`.

`\y{point register}`

Works like `\x`, only for the *y*-part.

Note that the above macros are available only inside a `let` operation.

Here is an example where `let` clauses are used to assemble a coordinate from the *x*-coordinate of a first point and the *y*-coordinate of a second point. Naturally, using the `|-` notation, this could be written much more compactly.

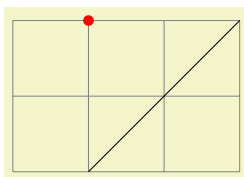

```
\begin{tikzpicture}
\draw [help lines] (0,0) grid (3,2);

\draw (1,0) coordinate (first point)
-- (3,2) coordinate (second point);

\fill[red] let \p1 = (first point),
\p2 = (second point) in
(\x1,\y2) circle [radius=2pt];
\end{tikzpicture}
```

Note that the effect of a `let` operation is local to the body of the `let` operation. If you wish to access a computed coordinate outside the body, you must use a `coordinate` path operation:

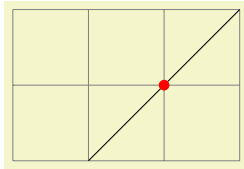

```

\begin{tikzpicture}
  \draw [help lines] (0,0) grid (3,2);

  \path % let's define some points:
  let
    \p1      = (1,0),
    \p2      = (3,2),
    \p{center} = ($ (\p1) !.5! (\p2) $) % center
  in
    coordinate (p1) at (\p1)
    coordinate (p2) at (\p2)
    coordinate (center) at (\p{center});

  \draw (p1) -- (p2);
  \fill[red] (center) circle [radius=2pt];
\end{tikzpicture}

```

For a more useful application of the let operation, let use draw a circle that touches a given line:

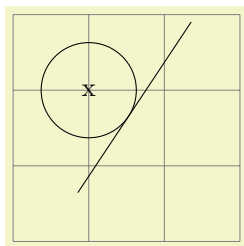

```

\begin{tikzpicture}
  \draw [help lines] (0,0) grid (3,3);

  \coordinate (a) at (rnd,rnd);
  \coordinate (b) at (3-rnd,3-rnd);
  \draw (a) -- (b);

  \node (c) at (1,2) {x};

  \draw let \p1 = ($ (a)!(c)!(b) - (c) $),
            \n1 = {veclen(\x1,\y1)}
            in circle [at=(c), radius=\n1];
\end{tikzpicture}

```

## 14.16 The Scoping Operation

When *TikZ* encounters an opening or a closing brace (`{` or `}`) at some point where a path operation should come, it will open or close a scope. All options that can be applied “locally” will be scoped inside the scope. For example, if you apply a transformation like `[xshift=1cm]` inside the scoped area, the shifting only applies to the scope. On the other hand, an option like `color=red` does not have any effect inside a scope since it can only be applied to the path as a whole.

Concerning the effect of scopes on relative coordinates, please see Section 13.4.2.

## 14.17 The Node and Edge Operations

There are two more operations that can be found in paths: `node` and `edge`. The first is used to add a so-called node to a path. This operation is special in the following sense: It does not change the current path in any way. In other words, this operation is not really a path operation, but has an effect that is “external” to the path. The `edge` operation has similar effect in that it adds something *after* the main path has been drawn. However, it works like the `to` operation, that is, it adds a `to` path to the picture after the main path has been drawn.

Since these operations are quite complex, they are described in the separate Section 16.

## 14.18 The PGF-Extra Operation

In some cases you may need to “do some calculations or some other stuff” while a path is constructed. For this, you would like to suspend the construction of the path and suspend *TikZ*’s parsing of the path, you would then like to have some *TeX* code executed, and would then like to resume the parsing of the path. This effect can be achieved using the following path operation `\pgfextra`. Note that this operation should only be used by real experts and should only be used deep inside clever macros, not on normal paths.

`\pgfextra{<code>}`

This command may only be used inside a *TikZ* path. There it is used like a normal path operation. The construction of the path is temporarily suspended and the `<code>` is executed. Then, the path construction is resumed.

```

\newdimen\mydim
\begin{tikzpicture}
  \mydim=1cm
  \draw (Opt,\mydim) \pgfextra{\mydim=2cm} -- (Opt,\mydim);
\end{tikzpicture}

```

### `\pgfextra`*(code)* `\endpgfextra`

This is an alternative syntax for the `\pgfextra` command. If the code following `\pgfextra` does not start with a brace, the *(code)* is executed until `\endpgfextra` is encountered. What actually happens is that `\pgfextra` that is not followed by a brace completely shuts down the TikZ parse and `\endpgfextra` is a normal macro that restarts the parser.

```

\newdimen\mydim
\begin{tikzpicture}
  \mydim=1cm
  \draw (Opt,\mydim)
    \pgfextra \mydim=2cm \endpgfextra -- (Opt,\mydim);
\end{tikzpicture}

```



## 15 Actions on Paths

### 15.1 Overview

Once a path has been constructed, different things can be done with it. It can be drawn (or stroked) with a “pen,” it can be filled with a color or shading, it can be used for clipping subsequent drawing, it can be used to specify the extend of the picture—or any combination of these actions at the same time.

To decide what is to be done with a path, two methods can be used. First, you can use a special-purpose command like `\draw` to indicate that the path should be drawn. However, commands like `\draw` and `\fill` are just abbreviations for special cases of the more general method: Here, the `\path` command is used to specify the path. Then, options encountered on the path indicate what should be done with the path.

For example, `\path (0,0) circle (1cm);` means “This is a path consisting of a circle around the origin. Do not do anything with it (throw it away).” However, if the option `draw` is encountered anywhere on the path, the circle will be drawn. “Anywhere” is any point on the path where an option can be given, which is everywhere where a path command like `circle (1cm)` or `rectangle (1,1)` or even just `(0,0)` would also be allowed. Thus, the following commands all draw the same circle:

```
\path [draw] (0,0) circle (1cm);
\path (0,0) [draw] circle (1cm);
\path (0,0) circle (1cm) [draw];
```

Finally, `\draw (0,0) circle (1cm);` also draws a path, because `\draw` is an abbreviation for `\path [draw]` and thus the command expands to the first line of the above example.

Similarly, `\fill` is an abbreviation for `\path[fill]` and `\filldraw` is an abbreviation for the command `\path[fill,draw]`. Since options accumulate, the following commands all have the same effect:

```
\path [draw,fill] (0,0) circle (1cm);
\path [draw] [fill] (0,0) circle (1cm);
\path [fill] (0,0) circle (1cm) [draw];
\draw [fill] (0,0) circle (1cm);
\fill (0,0) [draw] circle (1cm);
\filldraw (0,0) circle (1cm);
```

In the following subsection the different actions are explained that can be performed on a path. The following commands are abbreviations for certain sets of actions, but for many useful combinations there are no abbreviations:

#### `\draw`

Inside `{tikzpicture}` this is an abbreviation for `\path[draw]`.

#### `\fill`

Inside `{tikzpicture}` this is an abbreviation for `\path[fill]`.

#### `\filldraw`

Inside `{tikzpicture}` this is an abbreviation for `\path[fill,draw]`.

#### `\pattern`

Inside `{tikzpicture}` this is an abbreviation for `\path[pattern]`.

#### `\shade`

Inside `{tikzpicture}` this is an abbreviation for `\path[shade]`.

#### `\shadedraw`

Inside `{tikzpicture}` this is an abbreviation for `\path[shade,draw]`.

#### `\clip`

Inside `{tikzpicture}` this is an abbreviation for `\path[clip]`.

#### `\useasboundingbox`

Inside `{tikzpicture}` this is an abbreviation for `\path[use as bounding box]`.

## 15.2 Specifying a Color

The most unspecific option for setting colors is the following:

`/tikz/color=<color name>` (no default)

This option sets the color that is used for fill, drawing, and text inside the current scope. Any special settings for filling colors or drawing colors are immediately “overruled” by this option.

The `<color name>` is the name of a previously defined color. For  $\LaTeX$  users, this is just a normal “ $\LaTeX$ -color” and the `xcolor` extensions are allowed. Here is an example:



```
\tikz \fill[color=red!20] (0,0) circle (1ex);
```

It is possible to “leave out” the `color=` part and you can also write:



```
\tikz \fill[red!20] (0,0) circle (1ex);
```

What happens is that every option that TikZ does not know, like `red!20`, gets a “second chance” as a color name.

For plain  $\TeX$  users, it is not so easy to specify colors since plain  $\TeX$  has no “standardized” color naming mechanism. Because of this, PGF emulates the `xcolor` package, though the emulation is *extremely basic* (more precisely, what I could hack together in two hours or so). The emulation allows you to do the following:

- Specify a new color using `\definecolor`. Only the two color models `gray` and `rgb` are supported.  
*Example:* `\definecolor{orange}{rgb}{1,0.5,0}`
- Use `\colorlet` to define a new color based on an old one. Here, the `!` mechanism is supported, though only “once” (use multiple `\colorlet` for more fancy colors).  
*Example:* `\colorlet{lightgray}{black!25}`
- Use `\color{<color name>}` to set the color in the current  $\TeX$  group. `\aftergroup`-hackery is used to restore the color after the group.

As pointed out above, the `color=` option applies to “everything” (except to shadings), which is not always what you want. Because of this, there are several more specialized color options. For example, the `draw=` option sets the color used for drawing, but does not modify the color used for filling. These color options are documented where the path action they influence is described.

## 15.3 Drawing a Path

You can draw a path using the following option:

`/tikz/draw=<color>` (default is scope’s color setting)

Causes the path to be drawn. “Drawing” (also known as “stroking”) can be thought of as picking up a pen and moving it along the path, thereby leaving “ink” on the canvas.

There are numerous parameters that influence how a line is drawn, like the thickness or the dash pattern. These options are explained below.

If the optional `<color>` argument is given, drawing is done using the given `<color>`. This color can be different from the current filling color, which allows you to draw and fill a path with different colors. If no `<color>` argument is given, the last usage of the `color=` option is used.

If the special color name `none` is given, this option causes drawing to be “switched off.” This is useful if a style has previously switched on drawing and you locally wish to undo this effect.

Although this option is normally used on paths to indicate that the path should be drawn, it also makes sense to use the option with a `{scope}` or `{tikzpicture}` environment. However, this will *not* cause all path to draw. Instead, this just sets the `<color>` to be used for drawing paths inside the environment.

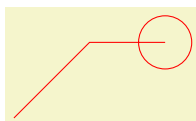

```
\begin{tikzpicture}
\path[draw=red] (0,0) -- (1,1) -- (2,1) circle (10pt);
\end{tikzpicture}
```

The following subsections list the different options that influence how a path is drawn. All of these options only have an effect if the `draw` options is given (directly or indirectly).

### 15.3.1 Graphic Parameters: Line Width, Line Cap, and Line Join

`/tikz/line width=<dimension>` (no default, initially 0.4pt)

Specifies the line width. Note the space.

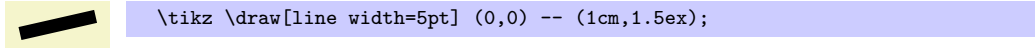

There are a number of predefined styles that provide more “natural” ways of setting the line width. You can also redefine these styles.

`/tikz/ultra thin` (style, no value)

Sets the line width to 0.1pt.

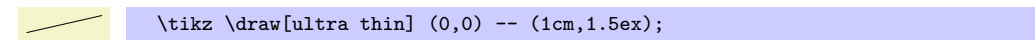

`/tikz/very thin` (style, no value)

Sets the line width to 0.2pt.

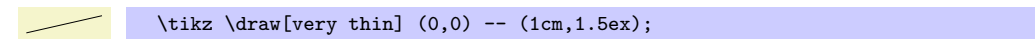

`/tikz/thin` (style, no value)

Sets the line width to 0.4pt.

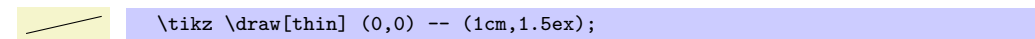

`/tikz/semithick` (style, no value)

Sets the line width to 0.6pt.

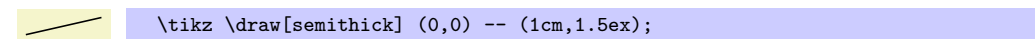

`/tikz/thick` (style, no value)

Sets the line width to 0.8pt.

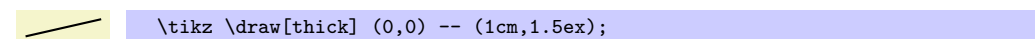

`/tikz/very thick` (style, no value)

Sets the line width to 1.2pt.

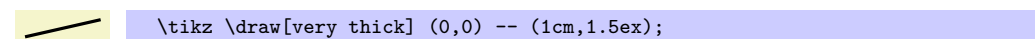

`/tikz/ultra thick` (style, no value)

Sets the line width to 1.6pt.



`/tikz/line cap=<type>` (no default, initially `butt`)

Specifies how lines “end.” Permissible *<type>* are `round`, `rect`, and `butt`. They have the following effects:



```
\begin{tikzpicture}
  \begin{scope}[line width=10pt]
    \draw[line cap=rect] (0,0) -- (1,0);
    \draw[line cap=butt] (0,.5) -- (1,.5);
    \draw[line cap=round] (0,1) -- (1,1);
  \end{scope}
  \draw[white,line width=1pt]
    (0,0) -- (1,0) (0,.5) -- (1,.5) (0,1) -- (1,1);
\end{tikzpicture}
```

`/tikz/line join=<type>` (no default, initially miter)

Specifies how lines “join.” Permissible *<type>* are round, bevel, and miter. They have the following effects:



```
\begin{tikzpicture}[line width=10pt]
  \draw[line join=round] (0,0) -- ++(.5,1) -- ++(.5,-1);
  \draw[line join=bevel] (1.25,0) -- ++(.5,1) -- ++(.5,-1);
  \draw[line join=miter] (2.5,0) -- ++(.5,1) -- ++(.5,-1);
  \useasboundingbox (0,1.5); % make bounding box bigger
\end{tikzpicture}
```

`/tikz/miter limit=<factor>` (no default, initially 10)

When you use the miter join and there is a very sharp corner (a small angle), the miter join may protrude very far over the actual joining point. In this case, if it were to protrude by more than *<factor>* times the line width, the miter join is replaced by a bevel join.



```
\begin{tikzpicture}[line width=5pt]
  \draw (0,0) -- ++(5,.5) -- ++(-5,.5);
  \draw[miter limit=25] (6,0) -- ++(5,.5) -- ++(-5,.5);
  \useasboundingbox (14,0); % make bounding box bigger
\end{tikzpicture}
```

### 15.3.2 Graphic Parameters: Dash Pattern

`/tikz/dash pattern=<dash pattern>` (no default)

Sets the dashing pattern. The syntax is the same as in METAFONT. For example following pattern on 2pt off 3pt on 4pt off 4pt means “draw 2pt, then leave out 3pt, then draw 4pt once more, then leave out 4pt again, repeat”.

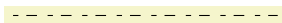

```
\begin{tikzpicture}[dash pattern=on 2pt off 3pt on 4pt off 4pt]
  \draw (0pt,0pt) -- (3.5cm,0pt);
\end{tikzpicture}
```

`/tikz/dash phase=<dash phase>` (no default, initially 0pt)

Shifts the start of the dash pattern by *<phase>*.

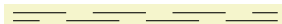

```
\begin{tikzpicture}[dash pattern=on 20pt off 10pt]
  \draw[dash phase=0pt] (0pt,3pt) -- (3.5cm,3pt);
  \draw[dash phase=10pt] (0pt,0pt) -- (3.5cm,0pt);
\end{tikzpicture}
```

As for the line thickness, some predefined styles allow you to set the dashing conveniently.

`/tikz/solid` (style, no value)

Shorthand for setting a solid line as “dash pattern.” This is the default.



```
\tikz \draw[solid] (0pt,0pt) -- (50pt,0pt);
```

`/tikz/dotted` (style, no value)  
Shorthand for setting a dotted dash pattern.

```
..... \tikz \draw[dotted] (0pt,0pt) -- (50pt,0pt);
```

`/tikz/densely dotted` (style, no value)  
Shorthand for setting a densely dotted dash pattern.

```
..... \tikz \draw[densely dotted] (0pt,0pt) -- (50pt,0pt);
```

`/tikz/loosely dotted` (style, no value)  
Shorthand for setting a loosely dotted dash pattern.

```
..... \tikz \draw[loosely dotted] (0pt,0pt) -- (50pt,0pt);
```

`/tikz/dashed` (style, no value)  
Shorthand for setting a dashed dash pattern.

```
----- \tikz \draw[dashed] (0pt,0pt) -- (50pt,0pt);
```

`/tikz/densely dashed` (style, no value)  
Shorthand for setting a densely dashed dash pattern.

```
----- \tikz \draw[densely dashed] (0pt,0pt) -- (50pt,0pt);
```

`/tikz/loosely dashed` (style, no value)  
Shorthand for setting a loosely dashed dash pattern.

```
- - - - - \tikz \draw[loosely dashed] (0pt,0pt) -- (50pt,0pt);
```

### 15.3.3 Graphic Parameters: Draw Opacity

When a line is drawn, it will normally “obscure” everything behind it as if you has used perfectly opaque ink. It is also possible to ask TikZ to use an ink that is a little bit (or a big bit) transparent using the `draw opacity` option. This is explained in Section 20 on transparency in more detail.

### 15.3.4 Graphic Parameters: Arrow Tips

When you draw a line, you can add arrow tips at the ends. It is only possible to add one arrow tip at the start and one at the end. If the path consists of several segments, only the last segment gets arrow tips. The behavior for paths that are closed is not specified and may change in the future.

`/tikz/arrows=<start arrow kind>-<end arrow kind>` (no default)

This option sets the start and end arrow tips (an empty value as in `->` indicates that no arrow tip should be drawn at the start).

*Note:* Since the arrow option is so often used, you can leave out the text `arrows=`. What happens is that every option that contains a `-` is interpreted as an arrow specification.

```
○————→ \begin{tikzpicture}  
————→ \draw[->] (0,0) -- (1,0);  
 \draw[o-stealth] (0,0.3) -- (1,0.3);  
 \end{tikzpicture}
```

The permissible values are all predefined arrow tips, though you can also define new arrow tip kinds as explained in Section 74. This is often necessary to obtain “double” arrow tips and arrow tips that have a fixed size. You need to load the `arrows` library if you need arrow tips other than the default ones, see Section 23.

One arrow tip kind is special:  $\gt$  (and all arrow tip kinds containing the arrow tip kind such as  $\ll$  or  $\gt|$ ). This arrow tip type is not fixed. Rather, you can redefine it using the  $\gt=$  option, see below.

*Example:* You can also combine arrow tip types as in

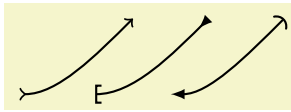

```
\begin{tikzpicture}[thick]
  \draw[to reversed-to] (0,0) .. controls +(.5,0) and +(-.5,-.5) .. +(1.5,1);
  \draw[[-latex reversed] (1,0) .. controls +(.5,0) and +(-.5,-.5) .. +(1.5,1);
  \draw[latex-] (2,0) .. controls +(.5,0) and +(-.5,-.5) .. +(1.5,1);
  \useasboundingbox (-.1,-.1) rectangle (3.1,1.1); % make bounding box bigger
\end{tikzpicture}
```

$\text{/tikz/}\gt=(end\ arrow\ kind)$

(no default)

This option can be used to redefine the “standard” arrow tip  $\gt$ . The idea is that different people have different ideas what arrow tip kind should normally be used. I prefer the arrow tip of  $\text{T}_{\text{E}}\text{X}$ ’s  $\backslash\text{to}$  command (which is used in things like  $f: A \rightarrow B$ ). Other people will prefer  $\text{L}^{\text{A}}\text{T}_{\text{E}}\text{X}$ ’s standard arrow tip, which looks like this:  $\rightarrow$ . Since the arrow tip kind  $\gt$  is certainly the most “natural” one to use, it is kept free of any predefined meaning. Instead, you can change it by saying  $\gt=\text{to}$  to set the “standard” arrow tip kind to  $\text{T}_{\text{E}}\text{X}$ ’s arrow tip, whereas  $\gt=\text{latex}$  will set it to  $\text{L}^{\text{A}}\text{T}_{\text{E}}\text{X}$ ’s arrow tip and  $\gt=\text{stealth}$  will use a  $\text{PSTRICKS}$ -like arrow tip.

Apart from redefining the arrow tip kind  $\gt$  (and  $\lt$  for the start), this option also redefines the following arrow tip kinds:  $\gt$  and  $\lt$  as the swapped version of  $\langle end\ arrow\ kind \rangle$ ,  $\ll$  and  $\gg$  as doubled versions,  $\gg$  and  $\ll$  as swapped doubled versions, and  $\lt|$  and  $\gt|$  as arrow tips ending with a vertical bar.

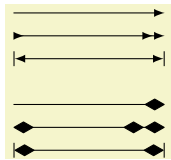

```
\begin{tikzpicture}[scale=2]
  \begin{scope}[>=latex]
    \draw[->] (0pt,6ex) -- (1cm,6ex);
    \draw[>->] (0pt,5ex) -- (1cm,5ex);
    \draw[|<->|] (0pt,4ex) -- (1cm,4ex);
  \end{scope}
  \begin{scope}[>=diamond]
    \draw[->] (0pt,2ex) -- (1cm,2ex);
    \draw[>->] (0pt,1ex) -- (1cm,1ex);
    \draw[|<->|] (0pt,0ex) -- (1cm,0ex);
  \end{scope}
\end{tikzpicture}
```

$\text{/tikz/shorten } \gt=(dimension)$

(no default, initially 0pt)

This option will shorten the end of lines by the given  $\langle dimension \rangle$ . If you specify an arrow tip, lines are already shortened a bit such that the arrow tip touches the specified endpoint and does not “protrude over” this point. Here is an example:

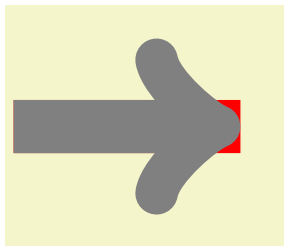

```
\begin{tikzpicture}[line width=20pt]
  \useasboundingbox (0,-1.5) rectangle (3.5,1.5);
  \draw[red] (0,0) -- (3,0);
  \draw[gray,->] (0,0) -- (3,0);
\end{tikzpicture}
```

The  $\text{shorten } \gt$  option allows you to shorten the end on the line *additionally* by the given distance. This option can also be useful if you have not specified an arrow tip at all.

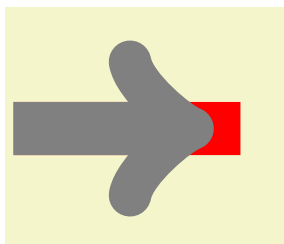

```
\begin{tikzpicture}[line width=20pt]
  \useasboundingbox (0,-1.5) rectangle (3.5,1.5);
  \draw[red] (0,0) -- (3,0);
  \draw[-to,shorten >=10pt,gray] (0,0) -- (3,0);
\end{tikzpicture}
```

`/tikz/shorten <=<dimension>` (no default)

Works like `shorten >`, but for the start.

### 15.3.5 Graphic Parameters: Double Lines and Bordered Lines

`/tikz/double=<core color>` (default `white`)

This option causes “two” lines to be drawn instead of a single one. However, this is not what really happens. In reality, the path is drawn twice. First, with the normal drawing color, secondly with the `<core color>`, which is normally `white`. Upon the second drawing, the line width is reduced. The net effect is that it appears as if two lines had been drawn and this works well even with complicated, curved paths:

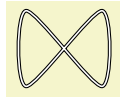

```
\tikz \draw[double]
plot[smooth cycle] coordinates{(0,0) (1,1) (1,0) (0,1)};
```

You can also use the doubling option to create an effect in which a line seems to have a certain “border”:

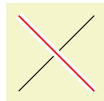

```
\begin{tikzpicture}
\draw (0,0) -- (1,1);
\draw[draw=white,double=red,very thick] (0,1) -- (1,0);
\end{tikzpicture}
```

`/tikz/double distance=<dimension>` (no default, initially `0.6pt`)

Sets the distance the “two” lines are spaced apart. In reality, this is the thickness of the line that is used to draw the path for the second time. The thickness of the *first* time the path is drawn is twice the normal line width plus the given `<dimension>`. As a side-effect, this option “selects” the `double` option.

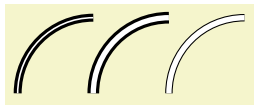

```
\begin{tikzpicture}
\draw[very thick,double] (0,0) arc (180:90:1cm);
\draw[very thick,double distance=2pt] (1,0) arc (180:90:1cm);
\draw[thin,double distance=2pt] (2,0) arc (180:90:1cm);
\end{tikzpicture}
```

`/tikz/double distance between line centers=<dimension>` (no default)

This option works like `double distance`, only the distance is not the distance between (inner) borders of the two main lines, but between their centers. Thus, the thickness the *first* time the path is drawn is the normal line width plus the given `<dimension>`, while the line width of the *second* line that is drawn is `<dimension>` minus the normal line width. As a side-effect, this option “selects” the `double` option.

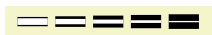

```
\begin{tikzpicture}[double distance between line centers=3pt]
\foreach \lw in {0.5,1,1.5,2,2.5}
\draw[line width=\lw pt,double] (\lw,0) -- ++(4mm,0);
\end{tikzpicture}
```

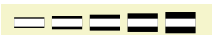

```
\begin{tikzpicture}[double distance=3pt]
\foreach \lw in {0.5,1,1.5,2,2.5}
\draw[line width=\lw pt,double] (\lw,0) -- ++(4mm,0);
\end{tikzpicture}
```

`/tikz/double equal sign distance` (style, no value)

This style selects a double line distance such that it corresponds to the distance of the two lines in an equal sign.

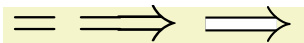

```
\Huge $\implies\tikz[baseline,double equal sign distance]
\draw[double,thick,-implies] (0,0.55ex) ---+(3ex,0);
```

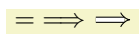

```
\normalsize $\implies\tikz[baseline,double equal sign distance]
\draw[double,-implies] (0,0.6ex) ---+(3ex,0);
```



```
\tiny $\implies\tikz[baseline,double equal sign distance]
\draw[double,very thin,-implies] (0,0.5ex) -- ++(3ex,0);
```

## 15.4 Filling a Path

To fill a path, use the following option:

`/tikz/fill=<color>` (default is scope's color setting)

This option causes the path to be filled. All unclosed parts of the path are first closed, if necessary. Then, the area enclosed by the path is filled with the current filling color, which is either the last color set using the general `color=` option or the optional color `<color>`. For self-intersection paths and for paths consisting of several closed areas, the “enclosed area” is somewhat complicated to define and two different definitions exist, namely the nonzero winding number rule and the even odd rule, see the explanation of these options, below.

Just as for the `draw` option, setting `<color>` to `none` disables filling locally.



```
\begin{tikzpicture}
  \fill (0,0) -- (1,1) -- (2,1);
  \fill (4,0) circle (.5cm) (4.5,0) circle (.5cm);
  \fill[even odd rule] (6,0) circle (.5cm) (6.5,0) circle (.5cm);
  \fill (8,0) -- (9,1) -- (10,0) circle (.5cm);
\end{tikzpicture}
```

If the `fill` option is used together with the `draw` option (either because both are given as options or because a `\filldraw` command is used), the path is filled *first*, then the path is drawn *second*. This is especially useful if different colors are selected for drawing and for filling. Even if the same color is used, there is a difference between this command and a plain `fill`: A “`filldraw`” area will be slightly larger than a filled area because of the thickness of the “pen.”



```
\begin{tikzpicture}[fill=examplefill,line width=5pt]
  \filldraw (0,0) -- (1,1) -- (2,1);
  \filldraw (4,0) circle (.5cm) (4.5,0) circle (.5cm);
  \filldraw[even odd rule] (6,0) circle (.5cm) (6.5,0) circle (.5cm);
  \filldraw (8,0) -- (9,1) -- (10,0) circle (.5cm);
\end{tikzpicture}
```

### 15.4.1 Graphic Parameters: Fill Pattern

Instead of filling a path with a single solid color, it is also possible to fill it with a *tiling pattern*. Imagine a small tile that contains a simple picture like a star. Then these tiles are (conceptually) repeated infinitely in all directions, but clipped against the path.

Tiling patterns come in two variants: *inherently colored patterns* and *form-only patterns*. An inherently colored pattern is, say, a red star with a black border and will always look like this. A form-only pattern may have a different color each time it is used, only the form of the pattern will stay the same. As such, form-only patterns do not have any colors of their own, but when it is used the current *pattern color* is used as its color.

Patterns are not overly flexible. In particular, it is not possible to change the size or orientation of a pattern without declaring a new pattern. For complicated case, it may be easier to use two nested `\foreach` statements to simulate a pattern, but patterns are rendered *much* more quickly than simulated ones.

`/tikz/pattern=<name>` (default is scope's pattern)

This option causes the path to be filled with a pattern. If the `<name>` is given, this pattern is used, otherwise the pattern set in the enclosing scope is used. As for the `draw` and `fill` options, setting `<name>` to `none` disables filling locally.



The pattern works like a fill color. In particular, setting a new fill color will fill the path with a solid color once more.

Strangely, no  $\langle name \rangle$ s are permissible by default. You need to load for instance `pgflibrarypatterns`, see Section 40, to install predefined patterns.

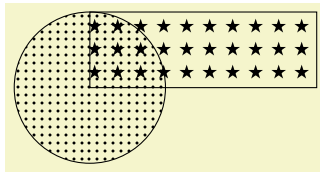

```
\begin{tikzpicture}
  \draw[pattern=dots] (0,0) circle (1cm);
  \draw[pattern=fivepointed stars] (0,0) rectangle (3,1);
\end{tikzpicture}
```

`/tikz/pattern color= $\langle color \rangle$`  (no default)

This option is used to set the color to be used for form-only patterns. This option has no effect on inherently colored patterns.

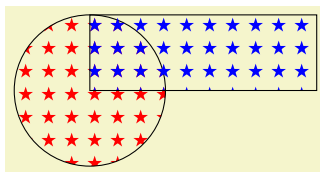

```
\begin{tikzpicture}
  \draw[pattern color=red,pattern=fivepointed stars] (0,0) circle (1cm);
  \draw[pattern color=blue,pattern=fivepointed stars] (0,0) rectangle (3,1);
\end{tikzpicture}
```

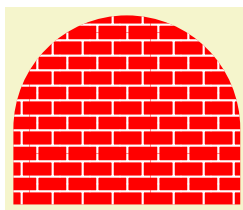

```
\begin{tikzpicture}
  \def\mypath{(0,0) -- +(0,1) arc (180:0:1.5cm) -- +(0,-1)}
  \fill [red] \mypath;
  \pattern[pattern color=white,pattern=bricks] \mypath;
\end{tikzpicture}
```

### 15.4.2 Graphic Parameters: Interior Rules

The following two options can be used to decide how interior points should be determined:

`/tikz/nonzero rule` (no value)

If this rule is used (which is the default), the following method is used to determine whether a given point is “inside” the path: From the point, shoot a ray in some direction towards infinity (the direction is chosen such that no strange borderline cases occur). Then the ray may hit the path. Whenever it hits the path, we increase or decrease a counter, which is initially zero. If the ray hits the path as the path goes “from left to right” (relative to the ray), the counter is increased, otherwise it is decreased. Then, at the end, we check whether the counter is nonzero (hence the name). If so, the point is deemed to lie “inside,” otherwise it is “outside.” Sounds complicated? It is.

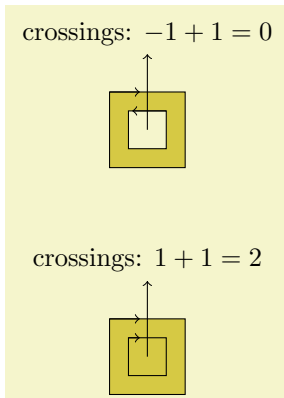

```
\begin{tikzpicture}
  \filldraw[fill=examplefill]
    % Clockwise rectangle
    (0,0) -- (0,1) -- (1,1) -- (1,0) -- cycle
    % Counter-clockwise rectangle
    (0.25,0.25) -- (0.75,0.25) -- (0.75,0.75) -- (0.25,0.75) -- cycle;

  \draw[->] (0,1) -- (.4,1);
  \draw[->] (0.75,0.75) -- (0.3,.75);

  \draw[->] (0.5,0.5) -- +(0,1) node[above] {crossings:  $-1+1 = 0$ };

  \begin{scope}[yshift=-3cm]
    \filldraw[fill=examplefill]
      % Clockwise rectangle
      (0,0) -- (0,1) -- (1,1) -- (1,0) -- cycle
      % Clockwise rectangle
      (0.25,0.25) -- (0.25,0.75) -- (0.75,0.75) -- (0.75,0.25) -- cycle;

    \draw[->] (0,1) -- (.4,1);
    \draw[->] (0.25,0.75) -- (0.4,.75);

    \draw[->] (0.5,0.5) -- +(0,1) node[above] {crossings:  $1+1 = 2$ };
  \end{scope}
\end{tikzpicture}
```

`/tikz/even odd rule`

(no value)

This option causes a different method to be used for determining the inside and outside of paths. While it is less flexible, it turns out to be more intuitive.

With this method, we also shoot rays from the point for which we wish to determine whether it is inside or outside the filling area. However, this time we only count how often we “hit” the path and declare the point to be “inside” if the number of hits is odd.

Using the even-odd rule, it is easy to “drill holes” into a path.

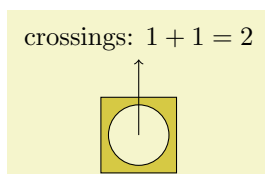

```
\begin{tikzpicture}
  \filldraw[fill=examplefill,even odd rule]
    (0,0) rectangle (1,1) (0.5,0.5) circle (0.4cm);
  \draw[->] (0.5,0.5) -- +(0,1) [above] node{crossings:  $1+1 = 2$ };
\end{tikzpicture}
```

### 15.4.3 Graphic Parameters: Fill Opacity

Analogously to the `draw opacity`, you can also set the filling opacity. Please see Section 20 for more details.

## 15.5 Generalized Filling: Using Arbitrary Pictures to Fill a Path

Sometimes you wish to “fill” a path with something even more complicated than a pattern, let alone a single color. For instance, you might wish to use an image to fill the path or some other, complicated drawing. In principle, this effect can be achieved by first using the path for clipping and then, subsequently, drawing the desired image or picture. However, there is an option that makes this process much easier:

`/tikz/path picture=code`

(no default)

When this option is given on a path and when the *code* is not empty, the following happens: After all other “filling” operations are done with the path, which are caused by the options `fill`, `pattern` and `shade`, a local scope is opened and the path is temporarily installed as a clipping path. Then, the *code* is executed, which can now draw something. Then, the local scope ends and, possibly, the path is stroked, provided the `draw` option has been given.

As with other keys like `fill` or `draw` this option needs to be given on a path, setting the `path picture` outside a path has not effect (the path picture is cleared at the beginning of each path).

The *code* can be any normal TikZ code like `\draw ...` or `\node ...`. As always, when you include an external graphic you need to put it inside a `\node`.

Note that no special actions are taken to transform the origin in any way. This means that the coordinate (0,0) is still where it was when the path was being constructed and not – as one might expect – at the lower left corner of the path. However, you can use the following special node to access the size of the path:

#### Predefined node `path picture bounding box`

This node is of shape `rectangle`. Its size and position are those of `current path bounding box` just before the `<code>` of the path picture started to be executed. The `<code>` can construct its own paths, so accessing the `current path bounding box` inside the `<code>` yields the bounding box of any path that is currently being constructed inside the `<code>`.

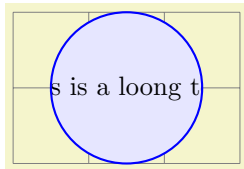

```
\begin{tikzpicture}
  \draw [help lines] (0,0) grid (3,2);
  \filldraw [fill=blue!10,draw=blue,thick] (1.5,1) circle (1)
    [path picture={
      \node at (path picture bounding box.center) {
        This is a loong text.
      };
    }];
\end{tikzpicture}
```

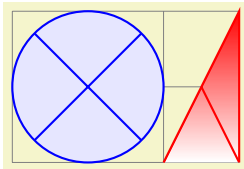

```
\begin{tikzpicture}[cross/.style={path picture={
  \draw[black]
    (path picture bounding box.south east) --
    (path picture bounding box.north west)
    (path picture bounding box.south west) --
    (path picture bounding box.north east);
}}]
  \draw [help lines] (0,0) grid (3,2);
  \filldraw [cross,fill=blue!10,draw=blue,thick] (1,1) circle (1);
  \path [cross,top color=red,draw=red,thick] (2,0) -- (3,2) -- (3,0);
\end{tikzpicture}
```

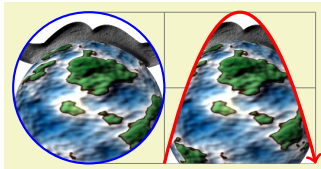

```
\begin{tikzpicture}[path image/.style={
  path picture={
    \node at (path picture bounding box.center) {
      \includegraphics[height=3cm]{#1}
    };
  }}]
  \draw [help lines] (0,0) grid (3,2);

  \draw [path image=brave-gnu-world-logo,draw=blue,thick]
    (0,1) circle (1);
  \draw [path image=brave-gnu-world-logo,draw=red,very thick,->]
    (1,0) parabola[parabola height=2cm] (3,0);
\end{tikzpicture}
```

## 15.6 Shading a Path

You can shade a path using the `shade` option. A shading is like a filling, only the shading changes its color smoothly from one color to another.

### `/tikz/shade`

(no value)

Causes the path to be shaded using the currently selected shading (more on this later). If this option is used together with the `draw` option, then the path is first shaded, then drawn.

It is not an error to use this option together with the `fill` option, but it makes no sense.

```
\tikz \shade (0,0) circle (1ex);
```

```
\tikz \shadedraw (0,0) circle (1ex);
```

For some shadings it is not really clear how they can “fill” the path. For example, the `ball` shading normally looks like this: . How is this supposed to shade a rectangle? Or a triangle?

To solve this problem, the predefined shadings like `ball` or `axis` fill a large rectangle completely in a sensible way. Then, when the shading is used to “shade” a path, what actually happens is that the path is temporarily used for clipping and then the rectangular shading is drawn, scaled and shifted such that all parts of the path are filled.

The default shading is a smooth transition from gray to white and from above to bottom. However, other shadings are also possible, for example a shading that will sweep a color from the center to the corners outward. To choose the shading, you can use the `shading=` option, which will also automatically invoke the `shade` option. Note that this does *not* change the shading color, only the way the colors sweep. For changing the colors, other options are needed, which are explained below.

`/tikz/shading=<name>` (no default)

This selects a shading named *<name>*. The following shadings are predefined: `axis`, `radial`, and `ball`.

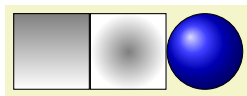

```
\tikz \shadedraw [shading=axis] (0,0) rectangle (1,1);
\tikz \shadedraw [shading=radial] (0,0) rectangle (1,1);
\tikz \shadedraw [shading=ball] (0,0) circle (.5cm);
```

The shadings as well as additional shadings are described in more detail in Section 44.

To change the color of a shading, special options are needed like `left color`, which sets the color of an axis shading from left to right. These options implicitly also select the right shading type, see the following example



```
\tikz \shadedraw [left color=red,right color=blue]
(0,0) rectangle (1,1);
```

For a complete list of the possible options see Section 44 once more.

`/tikz/shading angle=<degrees>` (no default, initially 0)

This option rotates the shading (not the path!) by the given angle. For example, we can turn a top-to-bottom axis shading into a left-to-right shading by rotating it by 90°.



```
\tikz \shadedraw [shading=axis,shading angle=90] (0,0) rectangle (1,1);
```

You can also define new shading types yourself. However, for this, you need to use the basic layer directly, which is, well, more basic and harder to use. Details on how to create a shading appropriate for filling paths are given in Section 83.3.

## 15.7 Establishing a Bounding Box

PGF is reasonably good at keeping track of the size of your picture and reserving just the right amount of space for it in the main document. However, in some cases you may want to say things like “do not count this for the picture size” or “the picture is actually a little large.” For this you can use the option `use as bounding box` or the command `\useasboundingbox`, which is just a shorthand for `\path[use as bounding box]`.

`/tikz/use as bounding box` (no value)

Normally, when this option is given on a path, the bounding box of the present path is used to determine the size of the picture and the size of all *subsequent* paths are ignored. However, if there were previous path operations that have already established a larger bounding box, it will not be made smaller by this operation.

In a sense, `use as bounding box` has the same effect as clipping all subsequent drawing against the current path—without actually doing the clipping, only making PGF treat everything as if it were clipped.

The first application of this option is to have a `{tikzpicture}` overlap with the main text:

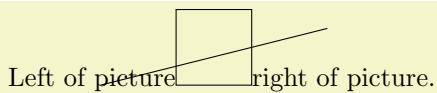

```
Left of picture\begin{tikzpicture}
\draw[use as bounding box] (2,0) rectangle (3,1);
\draw (1,0) -- (4,.75);
\end{tikzpicture}right of picture.
```

In a second application this option can be used to get better control over the white space around the picture:



```
Left of picture
\begin{tikzpicture}
\useasboundingbox (0,0) rectangle (3,1);
\fill (.75,.25) circle (.5cm);
\end{tikzpicture}
right of picture.
```

Note: If this option is used on a path inside a  $\text{T}_{\text{E}}\text{X}$  group (scope), the effect “lasts” only till the end of the scope. Again, this behavior is the same as for clipping.

There is a node that allows you to get the size of the current bounding box. The `current bounding box` node has the `rectangle` shape and its size is always the size of the current bounding box.

Similarly, the `current path bounding box` node has the `rectangle` shape and the size of the bounding box of the current path.

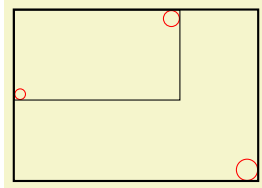

```
\begin{tikzpicture}
\draw[red] (0,0) circle (2pt);
\draw[red] (2,1) circle (3pt);

\draw (current bounding box.south west) rectangle
(current bounding box.north east);

\draw[red] (3,-1) circle (4pt);

\draw[thick] (current bounding box.south west) rectangle
(current bounding box.north east);
\end{tikzpicture}
```

## 15.8 Clipping and Fading (Soft Clipping)

*Clipping path* means that all painting on the page is restricted to a certain area. This area need not be rectangular, rather an arbitrary path can be used to specify this area. The `clip` option, explained below, is used to specify the region that is to be used for clipping.

A *fading* (a term that I propose, fadings are commonly known as soft masks, transparency masks, opacity masks or soft clips) is similar to clipping, but a fading allows parts of the picture to be only “half clipped.” This means that a fading can specify that newly painted pixels should be partly transparent. The specification and handling of fadings is a bit complex and it is detailed in Section 20, which is devoted to transparency in general.

`/tikz/clip` (no value)

This option causes all subsequent drawings to be clipped against the current path and the size of subsequent paths will not be important for the picture size. If you clip against a self-intersecting path, the even-odd rule or the nonzero winding number rule is used to determine whether a point is inside or outside the clipping region.

The clipping path is a graphic state parameter, so it will be reset at the end of the current scope. Multiple clippings accumulate, that is, clipping is always done against the intersection of all clipping areas that have been specified inside the current scopes. The only way of enlarging the clipping area is to end a `{scope}`.

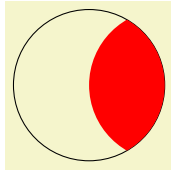

```
\begin{tikzpicture}
\draw[clip] (0,0) circle (1cm);
\fill[red] (1,0) circle (1cm);
\end{tikzpicture}
```

It is usually a *very* good idea to apply the `clip` option only to the first path command in a scope.

If you “only wish to clip” and do not wish to draw anything, you can use the `\clip` command, which is a shorthand for `\path[clip]`.

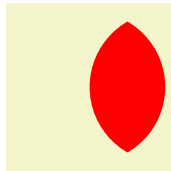

```
\begin{tikzpicture}
\clip (0,0) circle (1cm);
\fill[red] (1,0) circle (1cm);
\end{tikzpicture}
```

To keep clipping local, use `{scope}` environments as in the following example:



```
\begin{tikzpicture}
\draw (0,0) -- ( 0:1cm);
\draw (0,0) -- (10:1cm);
\draw (0,0) -- (20:1cm);
\draw (0,0) -- (30:1cm);
\begin{scope}[fill=red]
\fill[clip] (0.2,0.2) rectangle (0.5,0.5);
\draw (0,0) -- (40:1cm);
\draw (0,0) -- (50:1cm);
\draw (0,0) -- (60:1cm);
\end{scope}
\draw (0,0) -- (70:1cm);
\draw (0,0) -- (80:1cm);
\draw (0,0) -- (90:1cm);
\end{tikzpicture}
```

There is a slightly annoying catch: You cannot specify certain graphic options for the command used for clipping. For example, in the above code we could not have moved the `fill=red` to the `\fill` command. The reasons for this have to do with the internals of the PDF specification. You do not want to know the details. It is best simply not to specify any options for these commands.

## 15.9 Doing Multiple Actions on a Path

If more than one of the basic actions like drawing, clipping and filling are requested, they are automatically applied in a sensible order: First, a path is filled, then drawn, and then clipped (although it took Apple two mayor revisions of their operating system to get this right...). Sometimes, however, you need finer control over what is done with a path. For instance, you might wish to first fill a path with a color, then repaint the path with a pattern and then repaint it with yet another pattern. In such cases you can use the following two options:

`/tikz/preactions=<options>` (no default)

This option can be given to a `\path` command (or to derived commands like `\draw` which internally call `\path`). Similarly to options like `draw`, this option only has an effect when given to a `\path` or as part of the options of a `node`; as an option to a `{scope}` it has no effect.

When this option is used on a `\path`, the effect is the following: When the path has been completely constructed and is about to be used, a scope is created. Inside this scope, the path is used but not with the original path options, but with `<options>` instead. Then, the path is used in the usual manner. In other words, the path is used twice: Once with `<options>` in force and then again with the normal path options in force.

Here is an example in which the path consists of a rectangle. The main action is to draw this path in red (which is why we see a red rectangle). However, the preaction is to draw the path in blue, which is why we see a blue rectangle behind the red rectangle.

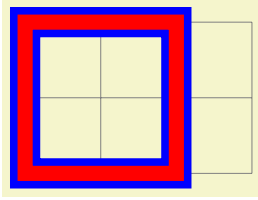

```
\begin{tikzpicture}
\draw[help lines] (0,0) grid (3,2);

\draw
[preaction={draw,line width=4mm,blue}]
[line width=2mm,red] (0,0) rectangle (2,2);
\end{tikzpicture}
```

Note that when the preactions are performed, then the path is already “finished.” In particular, applying a coordinate transformation to the path has no effect. By comparison, applying a canvas transformation does have an effect. Let us use this to add a “shadow” to a path. For this, we use the preaction to fill the path in gray, shifted a bit to the right and down:

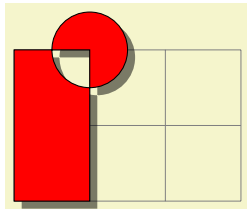

```
\begin{tikzpicture}
\draw[help lines] (0,0) grid (3,2);
\draw
[preaction={fill=black,opacity=.5,
transform canvas={xshift=1mm,yshift=-1mm}}]
[fill=red] (0,0) rectangle (1,2)
(1,2) circle (5mm);
\end{tikzpicture}
```

Naturally, you would normally create a style `shadow` that contains the above code. The `shadow` library, see Section 45, contains predefined shadows of this kind.

It is possible to use the `preaction` option multiple times. In this case, for each use of the `preaction` option, the path is used again (thus, the *options* do not accumulate in a single usage of the path). The path is used in the order of `preaction` options given.

In the following example, we use one `preaction` to add a shadow and another to provide a shading, while the main action is to use a pattern.

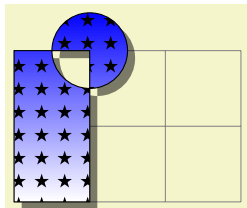

```
\begin{tikzpicture}
\draw[help lines] (0,0) grid (3,2);
\draw [pattern=fivepointed stars]
[preaction={fill=black,opacity=.5,
transform canvas={xshift=1mm,yshift=-1mm}}]
[preaction={top color=blue,bottom color=white}]
(0,0) rectangle (1,2)
(1,2) circle (5mm);
\end{tikzpicture}
```

A complicated application is shown in the following example, where the path is used several times with different fadings and shadings to create a special visual effect:

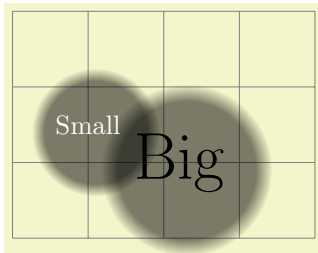

```

\begin{tikzpicture}
[
  % Define an interesting style
  button/.style={
    % First preaction: Fuzzy shadow
    preaction={fill=black,path fading=circle with fuzzy edge 20 percent,
      opacity=.5,transform canvas={xshift=1mm,yshift=-1mm}},
    % Second preaction: Background pattern
    preaction={pattern=#1,
      path fading=circle with fuzzy edge 15 percent},
    % Third preaction: Make background shiny
    preaction={top color=white,
      bottom color=black!50,
      shading angle=45,
      path fading=circle with fuzzy edge 15 percent,
      opacity=0.2},
    % Fourth preaction: Make edge especially shiny
    preaction={path fading=fuzzy ring 15 percent,
      top color=black!5,
      bottom color=black!80,
      shading angle=45},
    inner sep=2ex
  },
  button/.default=horizontal lines light blue,
  circle
]

\draw [help lines] (0,0) grid (4,3);

\node [button] at (2.2,1) {\Huge Big};
\node [button=crosshatch dots light steel blue,
  text=white] at (1,1.5) {Small};
\end{tikzpicture}

```

`/tikz/postaction=<options>`

(no default)

The postactions work in the same way as the preactions, only they are applied *after* the main action has been taken. Like preactions, multiple `postaction` options may be given to a `\path` command, in which case the path is reused several times, each time with a different set of options in force.

If both pre- and postactions are specified, then the preactions are taken first, then the main action, and then the post actions.

In the first example, we use a postaction to draw the path, after it has already been drawn:

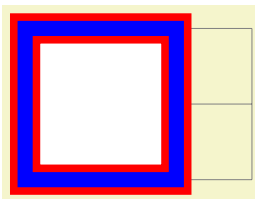

```

\begin{tikzpicture}
\draw[help lines] (0,0) grid (3,2);

\draw
[postaction={draw,line width=2mm,blue}]
[line width=4mm,red,fill=white] (0,0) rectangle (2,2);
\end{tikzpicture}

```

In another example, we use a postaction to “colorize” a path:

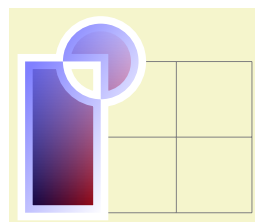

```

\begin{tikzpicture}
\draw[help lines] (0,0) grid (3,2);

\draw
[postaction={path fading=south,fill=white}]
[postaction={path fading=south,fading angle=45,fill=blue,opacity=.5}]
[left color=black,right color=red,draw=white,line width=2mm]
(0,0) rectangle (1,2)
(1,2) circle (5mm);
\end{tikzpicture}

```

## 15.10 Decorating and Morphing a Path

Before a path is used, it is possible to first “decorate” and/or “morph” it. Morphing means that the path is replaced by another path that slightly varied. Such morphings are a special case of the more general



“decorations” described in detail in Section 21. For instance, in the following example the path is drawn twice: Once normally and then in a morphed (=decorated) manner.

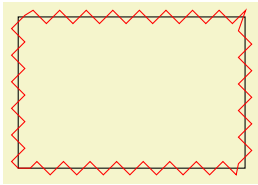

```
\begin{tikzpicture}
\draw (0,0) rectangle (3,2);
\draw [red, decorate, decoration=zigzag]
      (0,0) rectangle (3,2);
\end{tikzpicture}
```

Naturally, we could have combined this into a single command using pre- or postaction. It is also possible to deform shapes:

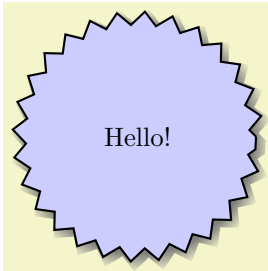

```
\begin{tikzpicture}
\node [circular drop shadow={shadow scale=1.05},minimum size=3.13cm,
       decorate, decoration=zigzag,
       fill=blue!20,draw,thick,circle] {Hello!};
\end{tikzpicture}
```

## 16 Nodes and Edges

### 16.1 Overview

In the present section, the usage of *nodes* in TikZ is explained. A node is typically a rectangle or circle or another simple shape with some text on it.

Nodes are added to paths using the special path operation `node`. Nodes *are not part of the path itself*. Rather, they are added to the picture after the path has been drawn.

In Section 16.2 the basic syntax of the node operation is explained, followed in Section 16.3 by the syntax for multi-part nodes, which are nodes that contain several different text parts. After this, the different options for the text in nodes are explained. In Section 16.5 the concept of *anchors* is introduced along with their usage. In Section 16.7 the different ways transformations affect nodes are studied. Sections 16.8 and 16.9 are about placing nodes on or next to straight lines and curves. In Section 16.11 it is explained how a node can be used as a “pseudo-coordinate.” Section 16.12 introduces the `edge` operation, which works similar to the `to` operation and also similar to the `node` operation.

### 16.2 Nodes and Their Shapes

In the simplest case, a node is just some text that is placed at some coordinate. However, a node can also have a border drawn around it or have a more complex background and foreground. Indeed, some nodes do not have a text at all, but consist solely of the background. You can name nodes so that you can reference their coordinates later in the same picture or, if certain precautions are taken as explained in Section 16.13, also in different pictures.

There are no special  $\text{\TeX}$  commands for adding a node to a picture; rather, there is path operation called `node` for this. Nodes are created whenever TikZ encounters `node` or `coordinate` at a point on a path where it would expect a normal path operation (like `-- (1,1)` or `sin (1,1)`). It is also possible to give node specifications *inside* certain path operations as explained later.

The node operation is typically followed by some options, which apply only to the node. Then, you can optionally *name* the node by providing a name in round braces. Lastly, for the `node` operation you must provide some label text for the node in curly braces, while for the `coordinate` operation you may not. The node is placed at the current position of the path *after the path has been drawn*. Thus, all nodes are drawn “on top” of the path and retained until the path is complete. If there are several nodes on a path, they are drawn on top of the path in the order they are encountered.

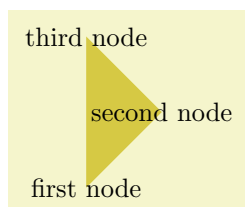

```
\tikz \fill[fill=examplefill]
(0,0) node {first node}
-- (1,1) node {second node}
-- (0,2) node {third node};
```

The syntax for specifying nodes is the following:

```
\path ... node[options](name)at(coordinate){text} ... ;
```

The effect of `at` is to place the node at the coordinate given after `at` and not, as would normally be the case, at the last position. The `at` syntax is not available when a node is given inside a path operation (it would not make any sense, there).

The (*name*) is a name for later reference and it is optional. You may also add the option `name=name` to the *option* list; it has the same effect.

```
/tikz/name=node name (no default)
```

Assigns a name to the node for later reference. Since this is a “high-level” name (drivers never know of it), you can use spaces, number, letters, or whatever you like when naming a node. Thus, you can name a node just `1` or perhaps `start of chart` or even `y_1`. Your node name should *not* contain any punctuation like a dot, a comma, or a colon since these are used to detect what kind of coordinate you mean when you reference a node.

```
/tikz/alias=another node name (no default)
```

This option allows you to provide another name for the node. Giving this option multiple times will allow you to access the node via several aliases. Using the `late options` options, you can also assign an alias name to a node at a later point.

`/tikz/at=<coordinate>` (no default)

This is another way of specifying `at` coordinate. Note that, typically, you will have to enclose the `<coordinate>` in curly braces so that a comma inside the `<coordinate>` does not confuse  $\TeX$ .

The `<options>` is an optional list of options that *apply only to the node* and have no effect outside. The other way round, most “outside” options also apply to the node, but not all. For example, the “outside” rotation does not apply to nodes (unless some special options are used, sigh). Also, the outside path action, like `draw` or `fill`, never applies to the node and must be given in the node (unless some special other options are used, deep sigh).

As mentioned before, we can add a border and even a background to a node:

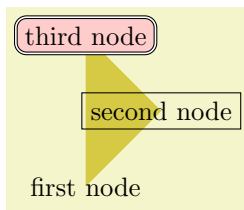

```
\tikz \fill[fill=examplefill]
(0,0) node {first node}
-- (1,1) node[draw] {second node}
-- (0,2) node[fill=red!20,draw,double,rounded corners] {third node};
```

The “border” is actually just a special case of a much more general mechanism. Each node has a certain *shape* which, by default, is a rectangle. However, we can also ask  $\text{TikZ}$  to use a circle shape instead or an ellipse shape (you have to include `pgflibraryshapes` for the latter shape):

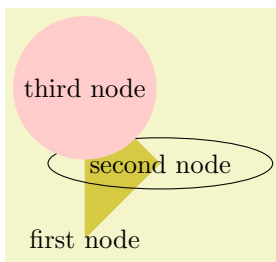

```
\tikz \fill[fill=examplefill]
(0,0) node{first node}
-- (1,1) node[ellipse,draw] {second node}
-- (0,2) node[fill=red!20] {third node};
```

In the future, there might be much more complicated shapes available such as, say, a shape for a resistor or a shape for a UML class. Unfortunately, creating new shapes is a bit tricky and makes it necessary to use the basic layer directly. Life is hard.

To select the shape of a node, the following option is used:

`/tikz/shape=<shape name>` (no default, initially `rectangle`)

Select the shape either of the current node or, when this option is not given inside a node but somewhere outside, the shape of all nodes in the current scope.

Since this option is used often, you can leave out the `shape=`. When  $\text{TikZ}$  encounters an option like `circle` that it does not know, it will, after everything else has failed, check whether this option is the name of some shape. If so, that shape is selected as if you had said `shape=<shape name>`.

By default, the following shapes are available: `rectangle`, `circle`, `coordinate`, and, when the package `pgflibraryshapes` is loaded, also `ellipse`. Details of these shapes, like their anchors and size options, are discussed in Section 16.2.1.

The following styles influences how nodes are rendered:

`/tikz/every node` (style, initially empty)

This style is installed at the beginning of every node.

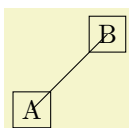

```
\begin{tikzpicture}[every node/.style={draw}]
\draw (0,0) node {A} -- (1,1) node {B};
\end{tikzpicture}
```

`/tikz/every <shape> node` (style, initially empty)

These styles are installed at the beginning of a node of a given *<shape>*. For example, every `rectangle` node is used for rectangle nodes, and so on.

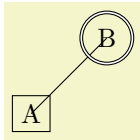

```
\begin{tikzpicture}
  [every rectangle node/.style={draw},
   every circle node/.style={draw,double}]
  \draw (0,0) node[rectangle] {A} -- (1,1) node[circle] {B};
\end{tikzpicture}
```

There is a special syntax for specifying “light-weighted” nodes:

```
\path ... coordinate[<options>](<name>)at(<coordinate>) ... ;
```

This has the same effect as

```
node[shape=coordinate][<options>](<name>)at(<coordinate>){} ,
```

where the `at` part might be missing.

Since nodes are often the only path operation on paths, there are two special commands for creating paths containing only a node:

`\node`

Inside `{tikzpicture}` this is an abbreviation for `\path node`.

`\coordinate`

Inside `{tikzpicture}` this is an abbreviation for `\path coordinate`.

### 16.2.1 Predefined Shapes

PGF and TikZ define three shapes, by default:

- `rectangle`,
- `circle`, and
- `coordinate`.

By loading library packages, you can define more shapes like ellipses or diamonds; see Section 46 for the complete list of shapes.

The `coordinate` shape is handled in a special way by TikZ. When a node `x` whose shape is `coordinate` is used as a coordinate (`x`), this has the same effect as if you had said (`x.center`). None of the special “line shortening rules” apply in this case. This can be useful since, normally, the line shortening causes paths to be segmented and they cannot be used for filling. Here is an example that demonstrates the difference:

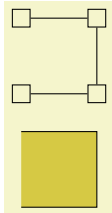

```
\begin{tikzpicture}[every node/.style={draw}]
  \path[yshift=1.5cm,shape=rectangle]
    (0,0) node(a1){} (1,0) node(a2){}
    (1,1) node(a3){} (0,1) node(a4){};
  \filldraw[fill=examplefill] (a1) -- (a2) -- (a3) -- (a4);

  \path[shape=coordinate]
    (0,0) coordinate(b1) (1,0) coordinate(b2)
    (1,1) coordinate(b3) (0,1) coordinate(b4);
  \filldraw[fill=examplefill] (b1) -- (b2) -- (b3) -- (b4);
\end{tikzpicture}
```

### 16.2.2 Common Options: Separations, Margins, Padding and Border Rotation

The exact behaviour of shapes differs, shapes defined for more special purposes (like a, say, transistor shape) will have even more custom behaviors. However, there are some options that apply to most shapes:

`/pgf/inner sep=<dimension>` (no default, initially `.3333em`)

alias `/tikz/inner sep`

An additional (invisible) separation space of  $\langle dimension \rangle$  will be added inside the shape, between the text and the shape's background path. The effect is as if you had added appropriate horizontal and vertical skips at the beginning and end of the text to make it a bit "larger."

For those familiar with CSS, this is the same as *padding*.

|         |                                                                                                                                                                                                        |
|---------|--------------------------------------------------------------------------------------------------------------------------------------------------------------------------------------------------------|
| default | <pre>\begin{tikzpicture}   \draw (0,0) node[inner sep=0pt,draw] {tight}         (0cm,2em) node[inner sep=5pt,draw] {loose}         (0cm,4em) node[fill=examplefill] {default}; \end{tikzpicture}</pre> |
| loose   |                                                                                                                                                                                                        |
| tight   |                                                                                                                                                                                                        |

`/pgf/inner xsep= $\langle dimension \rangle$`  (no default, initially `.3333em`)

alias `/tikz/inner xsep`

Specifies the inner separation in the  $x$ -direction, only.

`/pgf/inner ysep= $\langle dimension \rangle$`  (no default, initially `.3333em`)

alias `/tikz/inner ysep`

Specifies the inner separation in the  $y$ -direction, only.

`/pgf/outer sep= $\langle dimension \rangle$`  (no default, initially `.5\pgflinewidth`)

alias `/tikz/outer sep`

This option adds an additional (invisible) separation space of  $\langle dimension \rangle$  outside the background path. The main effect of this option is that all anchors will move a little "to the outside."

For those familiar with CSS, this is same as *margin*.

The default for this option is half the line width. When the default is used and when the background path is draw, the anchors will lie exactly on the "outside border" of the path (not on the path itself). When the shape is filled, but not drawn, this may not be desirable. In this case, the `outer sep` should be set to zero point.

|        |       |                                                                                                                                                                                                                                                                   |
|--------|-------|-------------------------------------------------------------------------------------------------------------------------------------------------------------------------------------------------------------------------------------------------------------------|
| filled | drawn | <pre>\begin{tikzpicture}   \draw[line width=5pt]     (0,0) node[outer sep=0pt,fill=examplefill] (f) {filled}     (2,0) node[inner sep=.5\pgflinewidth+2pt,draw] (d) {drawn};    \draw[-&gt;] (1,-1) -- (f);   \draw[-&gt;] (1,-1) -- (d); \end{tikzpicture}</pre> |
|        |       |                                                                                                                                                                                                                                                                   |

`/pgf/outer xsep= $\langle dimension \rangle$`  (no default, initially `.5\pgflinewidth`)

alias `/tikz/outer xsep`

Specifies the outer separation in the  $x$ -direction, only.

`/pgf/outer ysep= $\langle dimension \rangle$`  (no default, initially `.5\pgflinewidth`)

alias `/tikz/outer ysep`

Specifies the outer separation in the  $y$ -direction, only.

`/pgf/minimum height= $\langle dimension \rangle$`  (no default, initially `0pt`)

alias `/tikz/minimum height`

This option ensures that the height of the shape (including the inner, but ignoring the outer separation) will be at least  $\langle dimension \rangle$ . Thus, if the text plus the inner separation is not at least as large as  $\langle dimension \rangle$ , the shape will be enlarged appropriately. However, if the text is already larger than  $\langle dimension \rangle$ , the shape will not be shrunk.

|     |     |                                                                                                                                                       |
|-----|-----|-------------------------------------------------------------------------------------------------------------------------------------------------------|
| 1cm | 0cm | <pre>\begin{tikzpicture}   \draw (0,0) node[minimum height=1cm,draw] {1cm}         (2,0) node[minimum height=0cm,draw] {0cm}; \end{tikzpicture}</pre> |
|-----|-----|-------------------------------------------------------------------------------------------------------------------------------------------------------|

`/pgf/minimum width= $\langle dimension \rangle$`  (no default, initially `0pt`)

alias /tikz/minimum width

Same as minimum height, only for the width.

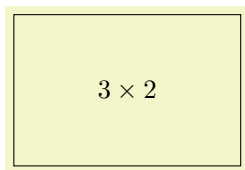

```
\begin{tikzpicture}
\draw (0,0) node[minimum height=2cm,minimum width=3cm,draw] {$3 \times 2$};
\end{tikzpicture}
```

/pgf/minimum size=(dimension)

(no default)

alias /tikz/minimum size

Sets both the minimum height and width at the same time.

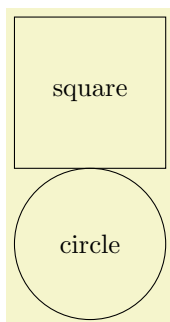

```
\begin{tikzpicture}
\draw (0,0) node[minimum size=2cm,draw] {square};
\draw (0,-2) node[minimum size=2cm,draw,circle] {circle};
\end{tikzpicture}
```

/pgf/shape aspect=(aspect ratio)

(no default)

alias /tikz/shape aspect

Sets a desired aspect ratio for the shape. For the diamond shape, this option sets the ratio between width and height of the shape.

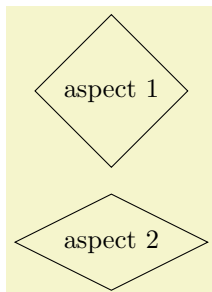

```
\begin{tikzpicture}
\draw (0,0) node[shape aspect=1,diamond,draw] {aspect 1};
\draw (0,-2) node[shape aspect=2,diamond,draw] {aspect 2};
\end{tikzpicture}
```

Some shapes (but not all), support a special kind of rotation. This rotation affects only the border of a shape and is independent of the node contents, but *in addition* to any other transformations.

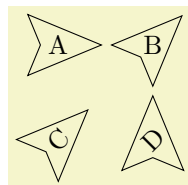

```
\tikzstyle{every node}=[dart, shape border uses incircle,
inner sep=1pt, draw]
\begin{tikzpicture}
\foreach \a/\b/\c in {A/0/0, B/45/0, C/0/45, D/45/45}
\node [shape border rotate=\b, rotate=\c] at (\b/36,-\c/36) {\a};
\end{tikzpicture}
```

There are two types of rotation: restricted and unrestricted. Which type of rotation is applied is determined by on how the shape border is constructed. If the shape border is constructed using an incircle, that is, a circle that tightly fits the node contents (including the `inner sep`), then the rotation can be unrestricted. If, however, the border is constructed using the natural dimensions of the node contents, the rotation is restricted to integer multiples of 90 degrees.

Why should there be two kinds of rotation and border construction? Borders constructed using the natural dimensions of the node contents provide a much tighter fit to the node contents, but to maintain this tight fit, the border rotation must be restricted to integer multiples of 90 degrees. By using an incircle, unrestricted rotation is possible, but the border will not make a very tight fit to the node contents.

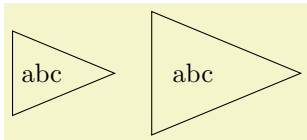

```
\tikzstyle{every node}=[isosceles triangle, draw]
\begin{tikzpicture}
  \node {abc};
  \node [shape border uses incircle] at (2,0) {abc};
\end{tikzpicture}
```

There are PGF keys determine how a shape border is constructed, and to specify its rotation. It should be noted that not all shapes support these keys, so reference should be made to the documentation for individual shapes.

`/pgf/shape border uses incircle=(boolean)` (default true)  
 alias `/tikz/shape border uses incircle`

Determines if the border of a shape is constructed using the incircle. If no value is given *(boolean)* will take the default value true.

`/pgf/shape border rotate=(angle)` (no default, initially 0)  
 alias `/tikz/shape border rotate`

Rotates the border of a shape independently of the node contents, but in addition to any other transformations. If the shape border is not constructed using the incircle, the rotation will be rounded to the nearest integer multiple of 90 degrees when the shape is drawn.

Note that if the border of the shape is rotated, the compass point anchors, and ‘text box’ anchors (including `mid east`, `base west`, and so on), *do not rotate*, but the other anchors do:

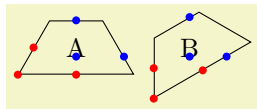

```
\tikzstyle{every node}=[shape=trapezium, draw, shape border uses incircle]
\begin{tikzpicture}
  \node at (0,0) (A) {A};
  \node [shape border rotate=30] at (1.5,0) (B) {B};
  \foreach \s/\t in
    {left side/base east, bottom side/north, bottom left corner/base}{
    \fill[red] (A.\s) circle(1.5pt) (B.\s) circle(1.5pt);
    \fill[blue] (A.\t) circle(1.5pt) (B.\t) circle(1.5pt);
  }
\end{tikzpicture}
```

Finally, a somewhat unfortunate side-effect of rotating shape borders is that the supporting shapes do not distinguish between `outer xsep` and `outer ysep`, and typically, the larger of the two values will be used.

### 16.3 Multi-Part Nodes

Most nodes just have a single simple text label. However, nodes of a more complicated shapes might be made up from several *node parts*. For example, in automata theory a so-called Moore state has a state name, drawn in the upper part of the state circle, and an output text, drawn in the lower part of the state circle. These two parts are quite independent. Similarly, a UML class shape would have a name part, a method part, and an attributes part. Different molecule shape might use parts for the different atoms to be drawn at the different positions, and so on.

Both PGF and TikZ support such multipart nodes. On the lower level, PGF provides a system for specifying that a shape consists of several parts. On the TikZ level, you specify the different node parts by using the following command:

`\nodepart [(options)] {(part name)}`

This command can only be used inside the *(text)* argument of a node path operation. It works a little bit like a `\part` command in L<sup>A</sup>T<sub>E</sub>X. It will stop the typesetting of whatever node part was typeset until now and then start putting all following text into the node part named *(part name)*—until another `\partname` is encountered or until the node *(text)* ends. The *(options)* will be local to this part.

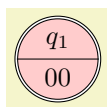

```
\begin{tikzpicture}
  \node [circle split,draw,double,fill=red!20]
  {
    % No \nodepart has been used, yet. So, the following is put in the
    % ‘text’ node part by default.
    $q_1$
    \nodepart{lower} % Ok, end ‘text’ part, start ‘output’ part
    $00$
  }; % output part ended.
\end{tikzpicture}
```

You will have to lookup which parts are defined by a shape.

The following styles influences node parts:

`/tikz/every <part name> node part` (style, initially empty)

This style is installed at the beginning of every node part named <part name>.

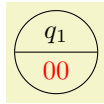

```
\tikz [every lower node part/.style={red}]
\node [circle split,draw] {$q_1$ \nodepart{lower} $00$};
```

## 16.4 The Node Text

### 16.4.1 Text Parameters: Color and Opacity

The simplest option for the text in nodes is its color. Normally, this color is just the last color installed using `color=`, possibly inherited from another scope. However, it is possible to specifically set the color used for text using the following option:

`/tikz/text=<color>` (no default)

Sets the color to be used for text labels. A `color=` option will immediately override this option.

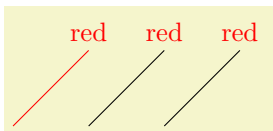

```
\begin{tikzpicture}
\draw[red] (0,0) -- +(1,1) node[above] {red};
\draw[text=red] (1,0) -- +(1,1) node[above] {red};
\draw (2,0) -- +(1,1) node[above,red] {red};
\end{tikzpicture}
```

Just like the color itself, you may also wish to set the opacity of the text only. For this, use the option `text opacity` option, which is detailed in Section 20.

### 16.4.2 Text Parameters: Font

Next, you may wish to adjust the font used for the text. Use the following option for this:

`/tikz/font=<font commands>` (no default)

Sets the font used for text labels.

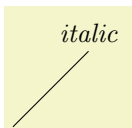

```
\begin{tikzpicture}
\draw[font=\itshape] (1,0) -- +(1,1) node[above] {italic};
\end{tikzpicture}
```

A perhaps more useful example is the following:

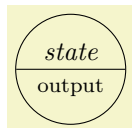

```
\tikz [every text node part/.style={font=\itshape},
every lower node part/.style={font=\footnotesize}]
\node [circle split,draw] {state \nodepart{lower} output};
```

### 16.4.3 Text Parameters: Alignment and Width for Multi-Line Text

Normally, when a node is typeset, all the text you give in the braces is put in one long line (in an `\hbox`, to be precise) and the node will become as wide as necessary.

From time to time you may wish to create nodes that contain multiple lines of text. There are three different ways of achieving this:

1. Inside the node, you can put some standard environment that produces multi-line, aligned text. For instance, you can use a `{tabular}` inside a node:



|            |             |
|------------|-------------|
| upper left | upper right |
| lower left | lower right |

```
\tikz \node [draw] {
  \begin{tabular}{cc}
    upper left & upper right\\
    lower left & lower right
  \end{tabular}
};
```

This approach offers the most flexibility in the sense that it allows you to use all of the alignment commands offered by your format of choice.

2. You use `\` inside your node to mark the end of lines and then request `TikZ` to arrange these lines in some manner. This will only be done, however, if the `align` option has been given.

|                             |
|-----------------------------|
| This is a<br>demonstration. |
|-----------------------------|

```
\tikz[align=left] \node[draw] {This is a\\demonstration.};
```

|                             |
|-----------------------------|
| This is a<br>demonstration. |
|-----------------------------|

```
\tikz[align=center] \node[draw] {This is a\\demonstration.};
```

The `\` command takes an optional extra space as an argument in square brackets.

|                                                    |
|----------------------------------------------------|
| This is a<br>demonstration text for<br>alignments. |
|----------------------------------------------------|

```
\tikz \node[fill=examplefill,align=right]
{This is a\\[-2pt] demonstration text for\\[1ex] alignments.};
```

3. You can request that `TikZ` does an automatic line-breaking for you inside the node by specifying a fixed `text width` for the node. In this case, you can still use `\` to enforce a line-break. Note that when you specify a text width, the node will have this width, independently of whether the text actually “reaches the end” of the node.

Let us now first have a look at the `text width` command.

`/tikz/text width=<dimension>` (no default)

This option will put the text of a node in a box of the given width (something akin to a `{minipage}` of this width, only portable across formats). If the node text is not as wide as `<dimension>`, it will nevertheless be put in a box of this width. If it is larger, line breaking will be done.

By default, when this option is given, a ragged right border will be used (`align=left`). This is sensible since, typically, these boxes are narrow and justifying the text looks ugly. You can, however, change the alignment using `align` or directly using commands like `\centering`.

|                                                                              |
|------------------------------------------------------------------------------|
| This is a demon-<br>stration text for<br>showing how line<br>breaking works. |
|------------------------------------------------------------------------------|

```
\tikz \draw (0,0) node[fill=examplefill,text width=3cm]
{This is a demonstration text for showing how line breaking works.};
```

Setting `<dimension>` to an empty string causes the automatic line breaking to be disabled.

`/tikz/align=<how>` (no default)

This key is used to setup an alignment for multi-line text inside a node. If `text width` is set to some width (let us call this *alignment with line breaking*), the `align` key will setup the `\leftskip` and the `\rightskip` in such a way that the text is broken and aligned according to `<how>`. If `text width` is not set (that is, set to the empty string; let us call this *alignment without line breaking*), then a different mechanism is used internally, namely the key `node halign header`, is set to an appropriate value. While

this key, which is documented below, is not to be used by beginners, the net effect is simple: When `text width` is not set, you can use `\` to break lines and align them according to *how* and the resulting node's width will be minimal to encompass the resulting lines.

In detail, you can set *how* to one of the following values:

**align=left** For alignment without line breaking, the different lines are simply aligned such that their left borders are below one another.

This is a demonstration text for alignments.

```
\tikz \node[fill=examplefill,align=left]
{This is a\ demonstration text for\ alignments.};
```

For alignment with line breaking, the same will happen only the lines will now, additionally, be broken automatically:

This is a demonstration text for showing how line breaking works.

```
\tikz \node[fill=examplefill,text width=3cm,align=left]
{This is a demonstration text for showing how line breaking works.};
```

**align=flush left** For alignment without line breaking this option has exactly the same effect as **left**. However, for alignment with line breaking, there is a difference: While **left** uses the original plain  $\text{\TeX}$  definition of a ragged right border, in which  $\text{\TeX}$  will try to balance the right border as well as possible, **flush left** causes the right border to be ragged in the  $\text{\LaTeX}$ -style, in which no balancing occurs. This looks ugly, but it may be useful for very narrow boxes and when you wish to avoid hyphenations.

This is a demonstration text for showing how line breaking works.

```
\tikz \node[fill=examplefill,text width=3cm,align=flush left]
{This is a demonstration text for showing how line breaking works.};
```

**align=right** Works like **left**, only for right alignment.

This is a demonstration text for alignments.

```
\tikz \node[fill=examplefill,align=right]
{This is a\ demonstration text for\ alignments.};
```

This is a demonstration text for showing how line breaking works.

```
\tikz \node[fill=examplefill,text width=3cm,align=right]
{This is a demonstration text for showing how line breaking works.};
```

**align=flush right** Works like **flush left**, only for right alignment.

This is a demonstration text for showing how line breaking works.

```
\tikz \node[fill=examplefill,text width=3cm,align=flush right]
{This is a demonstration text for showing how line breaking works.};
```

**align=center** Works like **left** or **right**, only for centered alignment.

This is a demonstration text for alignments.

```
\tikz \node[fill=examplefill,align=center]
{This is a\ demonstration text for\ alignments.};
```

This is a demonstration text for showing how line breaking works.

```
\tikz \node[fill=examplefill,text width=3cm,align=center]
{This is a demonstration text for showing how line breaking works.};
```

`align=flush center` Works like `flush left` or `flush right`, only for center alignment.

This is a demonstration text for showing how line breaking works.

```
\tikz \node[fill=examplefill,text width=3cm,align=flush center]
{This is a demonstration text for showing how line breaking works.};
```

`align=justify` For alignment without line breaking, this has the same effect as `left`. For alignment with line breaking, this causes the text to be “justified.” Use this only with pretty broad nodes.

This is a demonstration text for showing how line breaking works.

```
\tikz \node[fill=examplefill,text width=3cm,align=justify]
{This is a demonstration text for showing how line breaking works.};
```

In the above example,  $\text{T}_{\text{E}}\text{X}$  complains (rightfully) about three very badly typeset lines. (For this manual I asked  $\text{T}_{\text{E}}\text{X}$  to stop complaining by using `\hbadness=10000`, but this is a foul deed, indeed.)

`align=none` Disables all alignments and `\` will not be redefined.

`/tikz/node halign header=<macro storing a header>` (no default, initially empty)

This is the key that is used by `align` internally for alignment without line breaking. Read the following only if you are familiar with the `\halign` command.

This key only has an effect if `text width` is empty, otherwise it is ignored. Furthermore, if `<header>` is empty, then this key also has no effect. So, suppose `text width` is empty, but `<header>` is not. In this case the following happens:

When the node text is parsed, the command `\` is redefined internally. This redefinition is done in such a way that the text from the start of the node to the first occurrence of `\` is put in an `\hbox`. Then the text following `\` up to the next `\` is put in another `\hbox`. This goes on until the text between the last `\` and the closing `}` is also put in an `\hbox`.

The `<macro storing a header>` should be a macro that contains some text suitable for use as a header for the `\halign` command. For instance, you might define

```
\def\myheader{\hfil\hfil#\hfil\cr}
\tikz [node halign header=\myheader] ...
```

You cannot just say `node halign header=\hfil\hfil#\hfil\cr` because this confuses  $\text{T}_{\text{E}}\text{X}$  inside matrices, so this detour via a macro is needed.

Next, conceptually, all these boxes are recursively put inside an `\halign` command. Assuming that `<first>` is the first of the above boxes, the command `\halign{<header> \box<first> \cr}` is used to create a new box, which we will call the `<previous box>`. Then, the following box is created, where `<second>` is the second input box: `\halign{<header> \box<previous box> \cr \box<second> \cr}`. Let us call the resulting box the `<previous box>` once more. Then the next box that is created is `\halign{<header> \box<previous box> \cr \box<third> \cr}`.

All of this means that if `<header>` is an `\halign` header like `\hfil#\hfil\cr`, then all boxes will be centered relative to one another. Similarly, a `<header>` of `\hfil#\cr` causes the text to be flushed right. Note that this mechanism is not flexible enough to all multiple columns inside `<header>`. You will have to use a `tabular` or a `matrix` in such cases.

One further note: Since the text of each line is placed in a box, settings will be local to each “line.” This is very similar to the way a cell in a `tabular` or a `matrix` behaves.

### 16.4.4 Text Parameters: Height and Depth of Text

In addition to changing the width of nodes, you can also change the height of nodes. This can be done in two ways: First, you can use the option `minimum height`, which ensures that the height of the whole node is at least the given height (this option is described in more detail later). Second, you can use the option `text height`, which sets the height of the text itself, more precisely, of the  $\TeX$  text box of the text. Note that the `text height` typically is not the height of the shape's box: In addition to the `text height`, an internal `inner sep` is added as extra space and the text depth is also taken into account.

I recommend using `minimum size` instead of `text height` except for special situations.

`/tikz/text height=<dimension>` (no default)

Sets the height of the text boxes in shapes. Thus, when you write something like `node {text}`, the `text` is first typeset, resulting in some box of a certain height. This height is then replaced by the height `text height`. The resulting box is then used to determine the size of the shape, which will typically be larger. When you write `text height=` without specifying anything, the “natural” size of the text box remains unchanged.



```
\tikz \node[draw] {y};
\tikz \node[draw,text height=10pt] {y};
```

`/tikz/text depth=<dimension>` (no default)

This option works like `text height`, only for the depth of the text box. This option is mostly useful when you need to ensure a uniform depth of text boxes that need to be aligned.

## 16.5 Positioning Nodes

When you place a node at some coordinate, the node is centered on this coordinate by default. This is often undesirable and it would be better to have the node to the right or above the actual coordinate.

### 16.5.1 Positioning Nodes Using Anchors

PGF uses a so-called anchoring mechanism to give you a very fine control over the placement. The idea is simple: Imagining a node of rectangular shape of a certain size. PGF defines numerous anchor positions in the shape. For example to upper right corner is called, well, not “upper right anchor,” but the `north east` anchor of the shape. The center of the shape has an anchor called `center` on top of it, and so on. Here are some examples (a complete list is given in Section 16.2.1).

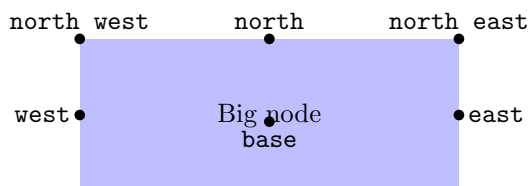

Now, when you place a node at a certain coordinate, you can ask *TikZ* to place the node shifted around in such a way that a certain anchor is at the coordinate. In the following example, we ask *TikZ* to shift the first node such that its `north east` anchor is at coordinate (0,0) and that the `west` anchor of the second node is at coordinate (1,1).

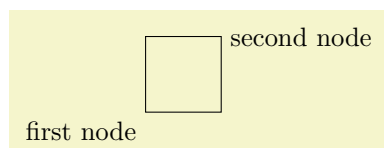

```
\tikz \draw (0,0) node[anchor=north east] {first node}
rectangle (1,1) node[anchor=west] {second node};
```

Since the default anchor is `center`, the default behaviour is to shift the node in such a way that it is centered on the current position.

`/tikz/anchor=<anchor name>` (no default)

Causes the node to be shifted such that its anchor *<anchor name>* lies on the current coordinate.

The only anchor that is present in all shapes is `center`. However, most shapes will at least define anchors in all “compass directions.” Furthermore, the standard shapes also define a `base` anchor, as well as `base west` and `base east`, for placing things on the baseline of the text.

The standard shapes also define a `mid` anchor (and `mid west` and `mid east`). This anchor is half the height of the character “x” above the base line. This anchor is useful for vertically centering multiple nodes that have different heights and depth. Here is an example:

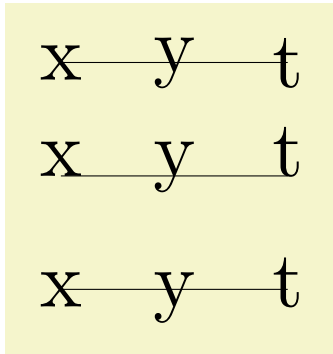

```
\begin{tikzpicture}[scale=3,transform shape]
% First, center alignment -> wobbles
\draw[anchor=center] (0,1) node{x} -- (0.5,1) node{y} -- (1,1) node{t};
% Second, base alignment -> no wobble, but too high
\draw[anchor=base] (0,.5) node{x} -- (0.5,.5) node{y} -- (1,.5) node{t};
% Third, mid alignment
\draw[anchor=mid] (0,0) node{x} -- (0.5,0) node{y} -- (1,0) node{t};
\end{tikzpicture}
```

### 16.5.2 Basic Placement Options

Unfortunately, while perfectly logical, it is often rather counter-intuitive that in order to place a node *above* a given point, you need to specify the `south` anchor. For this reason, there are some useful options that allow you to select the standard anchors more intuitively:

`/tikz/above=<offset>` (default 0pt)

Does the same as `anchor=south`. If the *<offset>* is specified, the node is additionally shifted upwards by the given *<offset>*.

above `\tikz \fill (0,0) circle (2pt) node[above] {above};`

above `\tikz \fill (0,0) circle (2pt) node[above=2pt] {above};`

`/tikz/below=<offset>` (default 0pt)

Similar to `above`.

`/tikz/left=<offset>` (default 0pt)

Similar to `above`.

`/tikz/right=<offset>` (default 0pt)

Similar to `above`.

`/tikz/above left` (no value)

Does the same as `anchor=south east`. Note that giving both `above` and `left` options does not have the same effect as `above left`, rather only the last `left` “wins.” Actually, this option also takes an

$\langle offset \rangle$  parameter, but using this parameter without using the `positioning` library is deprecated. (The `positioning` library changes the meaning of this parameter to something more sensible.)

above left

```
\tikz \fill (0,0) circle (2pt) node[above left] {above left};
```

`/tikz/above right` (no value)

Similar to above left.

above right

```
\tikz \fill (0,0) circle (2pt) node[above right] {above right};
```

`/tikz/below left` (no value)

Similar to above left.

`/tikz/below right` (no value)

Similar to above left.

### 16.5.3 Advanced Placement Options

While the standard placement options suffice for simple cases, the `positioning` library offers more convenient placement options.

```
\usetikzlibrary{positioning} % LATEX and plain TEX
\usetikzlibrary[positioning] % ConTEXt
```

The library defines additional options for placing nodes conveniently. It also redefines the standard options like `above` so that they give you better control of node placement.

When this library is loaded, the options like `above` or `above left` behave differently.

`/tikz/above= $\langle specification \rangle$`  (default `0pt`)

With the `positioning` library loaded, the `above` option does not take a simple  $\langle dimension \rangle$  as its parameter. Rather, it can (also) take a more elaborate  $\langle specification \rangle$  as parameter. This  $\langle specification \rangle$  has the following general form: It starts with an optional  $\langle shifting part \rangle$  and is followed by an optional  $\langle of-part \rangle$ . Let us start with the  $\langle shifting part \rangle$ , which can have three forms:

1. It can simply be a  $\langle dimension \rangle$  (or a mathematical expression that evaluates to a dimension) like `2cm` or `3cm/2+4cm`. In this case, the following happens: the node's anchor is set to `south` and the node is vertically shifted upwards by  $\langle dimension \rangle$ .

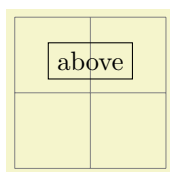

```
\begin{tikzpicture}
  \draw[help lines] (0,0) grid (2,2);
  \node at (1,1) [above=2pt+3pt,draw] {above};
\end{tikzpicture}
```

This use of the `above` option is the same as if the `positioning` library were not loaded.

2. It can be a  $\langle number \rangle$  (that is, any mathematical expression that does not include a unit like `pt` or `cm`). Examples are `2` or `3+sin(60)`. In this case, the anchor is also set to `south` and the node is vertically shifted by the vertical component of the coordinate  $(0, \langle number \rangle)$ .

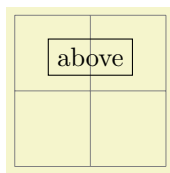

```
\begin{tikzpicture}
  \draw[help lines] (0,0) grid (2,2);
  \node at (1,1) [above=.2,draw] {above};
  % south border of the node is now 2mm above (1,1)
\end{tikzpicture}
```

3. It can be of the form *<number or dimension 1>* and *<number or dimension 2>*. This specification does not make particular sense for the `above` option, it is much more useful for options like `above left`. The reason it is allowed for the `above` option is that it is sometimes automatically used, as explained later.

The effect of this option is the following. First, the point  $(\langle\text{number of dimension 2}\rangle, \langle\text{number of dimension 1}\rangle)$  is computed (note the inversed order), using the normal rules for evaluating such a coordinate, yielding some position. Then, the node is shifted by the vertical component of this point. The anchor is set to `south`.

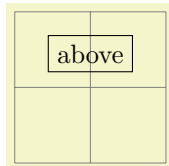

```
\begin{tikzpicture}
\draw[help lines] (0,0) grid (2,2);
\node at (1,1) [above=.2 and 3mm,draw] {above};
% south border of the node is also 2mm above (1,1)
\end{tikzpicture}
```

The *<shifting part>* can optionally be followed by a *<of-part>*, which has one of the following forms:

1. The *<of-part>* can be declared of *<coordinate>*, where *<coordinate>* is *not* in parentheses and it is *not* just a node name. An example would be of `somenode.north` or of `2,3`. In this case, the following happens: First, the node's `at` parameter is set to the *<coordinate>*. Second, the node is shifted according to the *<shift-part>*. Third, the anchor is set to `south`.

Here is a basic example:

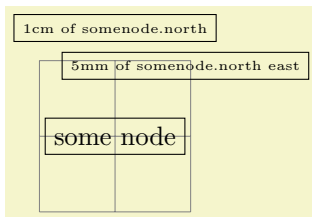

```
\begin{tikzpicture}[every node/.style=draw]
\draw[help lines] (0,0) grid (2,2);
\node (somenode) at (1,1) {some node};

\node [above=5mm of somenode.north east] {\tiny 5mm of somenode.north east};
\node [above=1cm of somenode.north] {\tiny 1cm of somenode.north};
\end{tikzpicture}
```

As can be seen the `above=5mm of somenode.north east` option does, indeed, place the node 5mm above the north east anchor of `somenode`. The same effect could have been achieved writing `above=5mm` followed by `at=(somenode.north east)`.

If the *<shift-part>* is missing, the shift is not zero, but rather the value of the `node distance` key is used, see below.

2. The *<of-part>* can have be of *<node name>*. An example would be of `somenode`. In this case, the following usually happens:
  - The anchor is set to `south`.
  - The node is shifted according to the *<shifting part>* or, if it is missing, according to the value of `node distance`.
  - The node's `at` parameter is set to *<node name>.north*.

The net effect of all this is that the new node will be placed in such a way that the distance between its south border and *<node name>*'s north border is exactly the given distance.

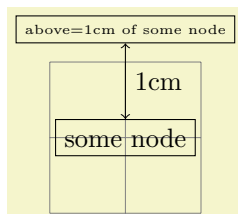

```
\begin{tikzpicture}[every node/.style=draw]
\draw[help lines] (0,0) grid (2,2);
\node (some node) at (1,1) {some node};

\node (other node) [above=1cm of some node] {\tiny above=1cm of some node};

\draw [<->] (some node.north) -- (other node.south)
node [midway,right,draw=none] {1cm};
\end{tikzpicture}
```

It is possible to change the behaviour of this *<specification>* rather drastically, using the following key:

`/tikz/on grid=<boolean>` (no default, initially `false`)

When this key is set to `true`, an *<of-part>* of the current form behaves differently: The anchors set for the current node as well as the anchor used for other *<node name>* are set the `center`.

This has the following effect: When you say `above=1cm` of `somenode` with `on grid` set to true, the new node will be placed in such a way that its center is 1cm above the center of `somenode`. Repeatedly placing nodes in this way will result in nodes that are centered on “grid coordinate,” hence the name of the option.

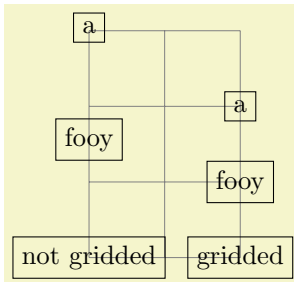

```
\begin{tikzpicture}[every node/.style=draw]
\draw[help lines] (0,0) grid (2,3);

% Not gridded
\node (a1) at (0,0) {not gridded};
\node (b1) [above=1cm of a1] {fooy};
\node (c1) [above=1cm of b1] {a};

% gridded
\node (a2) at (2,0) {gridded};
\node (b2) [on grid,above=1cm of a2] {fooy};
\node (c2) [on grid,above=1cm of b2] {a};
\end{tikzpicture}
```

`/tikz/node distance=<shifting part>`

(no default, initially 1cm and 1cm)

The value of this key is used as `<shifting part>` is used if and only if a `<of-part>` is present, but no `<shifting part>`.

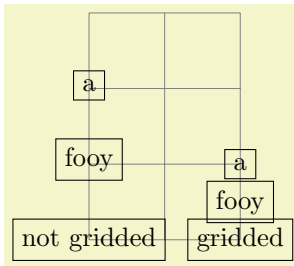

```
\begin{tikzpicture}[every node/.style=draw,node distance=5mm]
\draw[help lines] (0,0) grid (2,3);

% Not gridded
\node (a1) at (0,0) {not gridded};
\node (b1) [above=of a1] {fooy};
\node (c1) [above=of b1] {a};

% gridded
\begin{scope}[on grid]
\node (a2) at (2,0) {gridded};
\node (b2) [above=of a2] {fooy};
\node (c2) [above=of b2] {a};
\end{scope}
\end{tikzpicture}
```

`/tikz/below=<specification>`

(no default)

This key is redefined in the same manner as above.

`/tikz/left=<specification>`

(no default)

This key is redefined in the same manner as above, only all vertical shifts are replaced by horizontal shifts.

`/tikz/right=<specification>`

(no default)

This key is redefined in the same manner as left.

`/tikz/above left=<specification>`

(no default)

This key is also redefined in a manner similar to the above, but behaviour of the `<shifting part>` is more complicated:

1. When the `<shifting part>` is of the form `<number or dimension>` and `<number or dimension>`, it has (essentially) the effect of shifting the node vertically upwards by the first `<number or dimension>` and to the left by the second. To be more precise, the coordinate `(<second number or dimension>, <first number or dimension>)` is computed and then the node is shifted vertically by the *y*-part of the resulting coordinate and horizontally by the negated *x*-part of the result. (This is exactly what you expect, except possibly when you have used the `x` and `y` options to modify the `xy`-coordinate system so that the unit vectors no longer point in the expected directions.)
2. When the `<shifting part>` is of the form `<number or dimension>`, the node is shifted by this `<number or dimension>` in the direction of 135°. This means that there is a difference between a `<shifting part>` of 1cm and of 1cm and 1cm: In the second case, the node is shifted by 1cm upward and 1cm



to the left; in the first case it is shifted by  $\frac{1}{2}\sqrt{2}$ cm upward and by the same amount to the left. A more mathematical way of phrasing this is the following: A plain  $\langle dimension \rangle$  is measured in the  $l_2$ -norm, while a  $\langle dimension \rangle$  and  $\langle dimension \rangle$  is measured in the  $l_1$ -norm.

The following example should help to illustrate the difference:

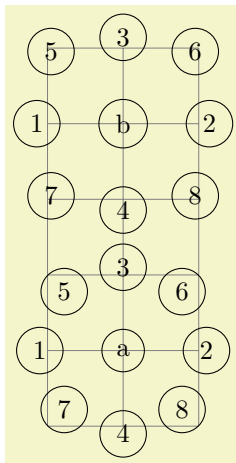

```
\begin{tikzpicture}[every node/.style={draw,circle}]
\draw[help lines] (0,0) grid (2,5);
\begin{scope}[node distance=5mm]
\node (a) at (1,1) {a};
\node [left=of a] {1}; \node [right=of a] {2};
\node [above=of a] {3}; \node [below=of a] {4};
\node [above left=of a] {5}; \node [above right=of a] {6};
\node [below left=of a] {7}; \node [below right=of a] {8};
\end{scope}
\begin{scope}[node distance=5mm and 5mm]
\node (b) at (1,4) {b};
\node [left=of b] {1}; \node [right=of b] {2};
\node [above=of b] {3}; \node [below=of b] {4};
\node [above left=of b] {5}; \node [above right=of b] {6};
\node [below left=of b] {7}; \node [below right=of b] {8};
\end{scope}
\end{tikzpicture}
```

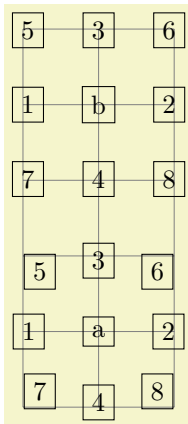

```
\begin{tikzpicture}[every node/.style={draw,rectangle}]
\draw[help lines] (0,0) grid (2,5);
\begin{scope}[node distance=5mm]
\node (a) at (1,1) {a};
\node [left=of a] {1}; \node [right=of a] {2};
\node [above=of a] {3}; \node [below=of a] {4};
\node [above left=of a] {5}; \node [above right=of a] {6};
\node [below left=of a] {7}; \node [below right=of a] {8};
\end{scope}
\begin{scope}[node distance=5mm and 5mm]
\node (b) at (1,4) {b};
\node [left=of b] {1}; \node [right=of b] {2};
\node [above=of b] {3}; \node [below=of b] {4};
\node [above left=of b] {5}; \node [above right=of b] {6};
\node [below left=of b] {7}; \node [below right=of b] {8};
\end{scope}
\end{tikzpicture}
```

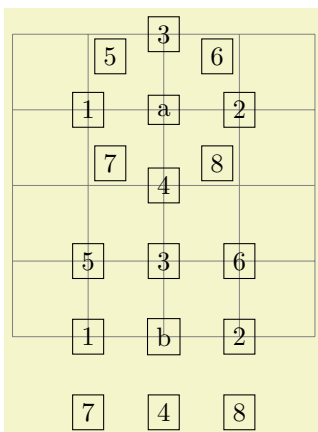

```
\begin{tikzpicture}[every node/.style={draw,rectangle,on grid}]
\draw[help lines] (0,0) grid (4,4);
\begin{scope}[node distance=1]
\node (a) at (2,3) {a};
\node [left=of a] {1}; \node [right=of a] {2};
\node [above=of a] {3}; \node [below=of a] {4};
\node [above left=of a] {5}; \node [above right=of a] {6};
\node [below left=of a] {7}; \node [below right=of a] {8};
\end{scope}
\begin{scope}[node distance=1 and 1]
\node (b) at (2,0) {b};
\node [left=of b] {1}; \node [right=of b] {2};
\node [above=of b] {3}; \node [below=of b] {4};
\node [above left=of b] {5}; \node [above right=of b] {6};
\node [below left=of b] {7}; \node [below right=of b] {8};
\end{scope}
\end{tikzpicture}
```

`/tikz/below left= $\langle specification \rangle$`  (no default)

Works similar to above left.

`/tikz/above left= $\langle specification \rangle$`  (no default)

Works similar to above left.

`/tikz/above right= $\langle specification \rangle$`  (no default)

Works similar to above left.

The `positioning` package also introduces the following new placement keys:

`/tikz/base left=<specification>` (no default)

This key works like the `left` key, only instead of the `east` anchor, the `base east` anchor is used and, when the second form of an *<of-part>* is used, the corresponding `base west` anchor.

This key is useful for chaining together nodes so that their base lines are aligned.

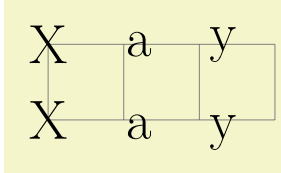

```
\begin{tikzpicture}[node distance=1ex]
\draw[help lines] (0,0) grid (3,1);
\huge
\node (X) at (0,1) {X};
\node (a) [right=of X] {a};
\node (y) [right=of a] {y};

\node (X) at (0,0) {X};
\node (a) [base right=of X] {a};
\node (y) [base right=of a] {y};
\end{tikzpicture}
```

`/tikz/base right=<specification>` (no default)

Works like `base left`.

`/tikz/mid left=<specification>` (no default)

Works like `base left`, but with `mid east` and `mid west` anchors instead of `base east` and `base west`.

`/tikz/mid right=<specification>` (no default)

Works like `mid left`.

#### 16.5.4 Arranging Nodes Using a Chains and Matrices

The simple `above` and `right` options may not always suffice for arranging a large number of nodes. For such situations TikZ offers two libraries that make positioning easier: The `chains` library and the `matrix` library. The first is mostly useful for creating “chains of nodes” and, more generally, “flows.” The second allows you to arrange multiple nodes in rows and columns. These methods for positioning nodes are described in two separate Sections 17 and 27.

### 16.6 Fitting Nodes to a Set of Coordinates

It is sometimes desirable that the size and position of a node is not given using anchors and size parameters, rather one would sometimes have a box be placed and be sized such that it “is just large enough to contain this, that, and that point.” This situation typically arises when a picture has been drawn and, afterwards, parts of the picture are supposed to be encircled or highlighted.

In this situation the `fit` option from the `fit` library is useful, see Section 33 for a the details. The idea is that you may give the `fit` option to a node. The `fit` option expects a list of coordinates (one after the other without commas) as its parameter. The effect will be that the node’s text area has exactly the necessary size so that it contains all the given coordinates. Here is an example:

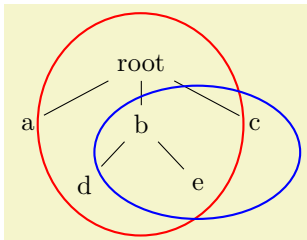

```
\begin{tikzpicture}[level distance=8mm]
\node (root) {root}
  child { node (a) {a} }
  child { node (b) {b} }
  child { node (c) {c} }
  child { node (d) {d} }
  child { node (e) {e} }
  child { node (c) {c} };

\node[draw=red,inner sep=0pt,thick,ellipse,fit=(root) (b) (d) (e)] {};
\node[draw=blue,inner sep=0pt,thick,ellipse,fit=(b) (c) (e)] {};
\end{tikzpicture}
```

If you want to fill the fitted node you will usually have to place it on a background layer.

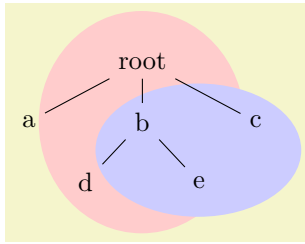

```
\begin{tikzpicture}[level distance=8mm]
  \node (root) {root}
  child { node (a) {a} }
  child { node (b) {b} }
    child { node (d) {d} }
    child { node (e) {e} } }
  child { node (c) {c} };

\begin{pgfonlayer}{background}
  \node[fill=red!20,inner sep=0pt,ellipse,fit=(root) (b) (d) (e)] {};
  \node[fill=blue!20,inner sep=0pt,ellipse,fit=(b) (c) (e)] {};
\end{pgfonlayer}
\end{tikzpicture}
```

## 16.7 Transformations

It is possible to transform nodes, but, by default, transformations do not apply to nodes. The reason is that you usually do *not* want your text to be scaled or rotated even if the main graphic is transformed. Scaling text is evil, rotating slightly less so.

However, sometimes you *do* wish to transform a node, for example, it certainly sometimes makes sense to rotate a node by 90 degrees. There are two ways in which you can achieve this:

1. You can use the following option:

`/tikz/transform shape` (no value)

Causes the current “external” transformation matrix to be applied to the shape. For example, if you said `\tikz[scale=3]` and then say `node[transform shape] {X}`, you will get a “huge” X in your graphic.

2. You can give transformation option *inside* the option list of the node. *These* transformations always apply to the node.

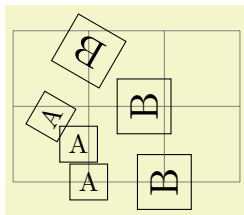

```
\begin{tikzpicture}[every node/.style={draw}]
  \draw[help lines](0,0) grid (3,2);
  \draw (1,0) node{A}
        (2,0) node[rotate=90,scale=1.5] {B};
  \draw[rotate=30] (1,0) node{A}
                  (2,0) node[rotate=90,scale=1.5] {B};
  \draw[rotate=60] (1,0) node[transform shape] {A}
                  (2,0) node[transform shape,rotate=90,scale=1.5] {B};
\end{tikzpicture}
```

## 16.8 Placing Nodes on a Line or Curve Explicitly

Until now, we always placed node on a coordinate that is mentioned in the path. Often, however, we wish to place nodes on “the middle” of a line and we do not wish to compute these coordinates “by hand.” To facilitate such placements, TikZ allows you to specify that a certain node should be somewhere “on” a line. There are two ways of specifying this: Either explicitly by using the `pos` option or implicitly by placing the node “inside” a path operation. These two ways are described in the following.

`/tikz/pos=<fraction>` (no default)

When this option is given, the node is not anchored on the last coordinate. Rather, it is anchored on some point on the line from the previous coordinate to the current point. The *<fraction>* dictates how “far” on the line the point should be. A *<fraction>* of 0 is the previous coordinate, 1 is the current one, everything else is in between. In particular, 0.5 is the middle.

Now, what is “the previous line”? This depends on the previous path construction operation.

In the simplest case, the previous path operation was a “line-to” operation, that is, a `--<coordinate>` operation:

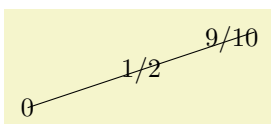

```
\tikz \draw (0,0) -- (3,1)
  node[pos=0]{0} node[pos=0.5]{1/2} node[pos=0.9]{9/10};
```

The next case is the curve-to operation (the `..` operation). In this case, the “middle” of the curve, that is, the position 0.5 is not necessarily the point at the exact half distance on the line. Rather, it is some point at “time” 0.5 of a point traveling from the start of the curve, where it is at time 0, to the end of the curve, which it reaches at time 0.5. The “speed” of the point depends on the length of the support vectors (the vectors that connect the start and end points to the control points). The exact math is a bit complicated (depending on your point of view, of course); you may wish to consult a good book on computer graphics and Bézier curves if you are intrigued.

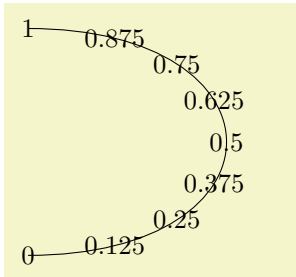

```
\tikz \draw (0,0) .. controls +(right:3.5cm) and +(right:3.5cm) .. (0,3)
\foreach \p in {0,0.125,...,1} {node[pos=\p]{\p}};
```

Another interesting case are the horizontal/vertical line-to operations `|-` and `-|`. For them, the position (or time) 0.5 is exactly the corner point.

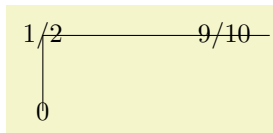

```
\tikz \draw (0,0) |- (3,1)
node[pos=0]{0} node[pos=0.5]{1/2} node[pos=0.9]{9/10};
```

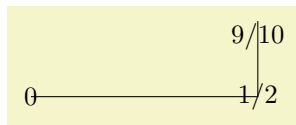

```
\tikz \draw (0,0) -| (3,1)
node[pos=0]{0} node[pos=0.5]{1/2} node[pos=0.9]{9/10};
```

For all other path construction operations, *the position placement does not work*, currently. This will hopefully change in the future (especially for the arc operation).

`/tikz/auto=<left or right>`

(default is scope’s setting)

This option causes an anchor positions to be calculated automatically according to the following rule. Consider a line between two points. If the `<direction>` is `left`, then the anchor is chosen such that the node is to the left of this line. If the `<direction>` is `right`, then the node is to the right of this line. Leaving out `<direction>` causes automatic placement to be enabled with the last value of `left` or `right` used. A `<direction>` of `false` disables automatic placement. This happens also whenever an anchor is given explicitly by the `anchor` option or by one of the `above`, `below`, etc. options.

This option only has an effect for nodes that are placed on lines or curves.

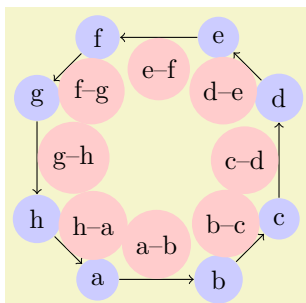

```
\begin{tikzpicture}
[scale=.8,auto=left,every node/.style={circle,fill=blue!20}]
\node (a) at (-1,-2) {a};
\node (b) at ( 1,-2) {b};
\node (c) at ( 2,-1) {c};
\node (d) at ( 2, 1) {d};
\node (e) at ( 1, 2) {e};
\node (f) at (-1, 2) {f};
\node (g) at (-2, 1) {g};
\node (h) at (-2,-1) {h};

\foreach \from/\to in {a/b,b/c,c/d,d/e,e/f,f/g,g/h,h/a}
\draw [->] (\from) -- (\to)
node[midway,fill=red!20] {\from--\to};
\end{tikzpicture}
```

`/tikz/swap`

(no value)

This option exchanges the roles of `left` and `right` in automatic placement. That is, if `left` is the current auto placement, `right` is set instead and the other way round.

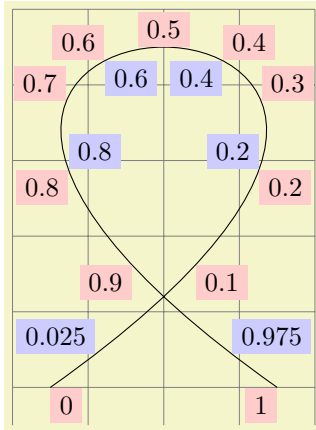

```
\begin{tikzpicture}[auto]
\draw[help lines,use as bounding box] (0,-.5) grid (4,5);

\draw (0.5,0) .. controls (9,6) and (-5,6) .. (3.5,0)
\foreach \pos in {0,0.1,0.2,0.3,0.4,0.5,0.6,0.7,0.8,0.9,1}
{node [pos=\pos,swap,fill=red!20] {\pos}}
\foreach \pos in {0.025,0.2,0.4,0.6,0.8,0.975}
{node [pos=\pos,fill=blue!20] {\pos}};
\end{tikzpicture}
```

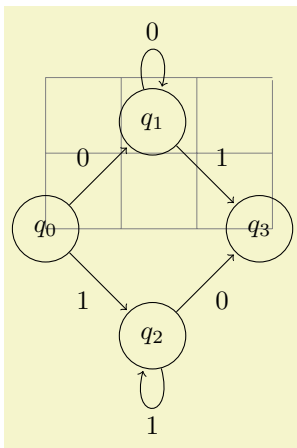

```
\begin{tikzpicture}[shorten >=1pt,node distance=2cm,auto]
\draw[help lines] (0,0) grid (3,2);

\node[state] (q_0) {$q_0$};
\node[state] (q_1) [above right of=q_0] {$q_1$};
\node[state] (q_2) [below right of=q_0] {$q_2$};
\node[state] (q_3) [below right of=q_1] {$q_3$};

\path[->] (q_0) edge node {0} (q_1)
edge node [swap] {1} (q_2)
(q_1) edge node {1} (q_3)
edge [loop above] node {} (q_1)
(q_2) edge node [swap] {0} (q_3)
edge [loop below] node {1} (q_2);
\end{tikzpicture}
```

`/tikz/sloped`

(no value)

This option causes the node to be rotated such that a horizontal line becomes a tangent to the curve. The rotation is normally done in such a way that text is never “upside down.” To get upside-down text, use can use `[rotate=180]` or `[allow upside down]`, see below.

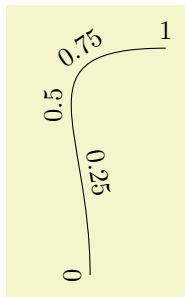

```
\tikz \draw (0,0) .. controls +(up:2cm) and +(left:2cm) .. (1,3)
\foreach \p in {0,0.25,...,1} {node[sloped,above,pos=\p] {\p}};
```

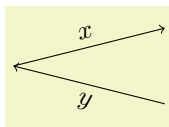

```
\begin{tikzpicture}[->]
\draw (0,0) -- (2,0.5) node[midway,sloped,above] {$x$};
\draw (2,-.5) -- (0,0) node[midway,sloped,below] {$y$};
\end{tikzpicture}
```

`/tikz/allow upside down=boolean`

(default true, initially false)

If set to true, TikZ will not “righten” upside down text.

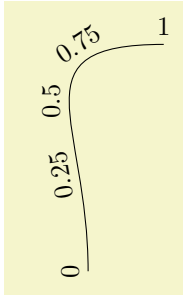

```
\tikz [allow upside down]
\draw (0,0) .. controls +(up:2cm) and +(left:2cm) .. (1,3)
\foreach \p in {0,0.25,...,1} {node[sloped,above,pos=\p]{\p}};
```

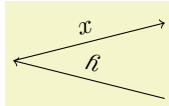

```
\begin{tikzpicture}[->,allow upside down]
\draw (0,0) -- (2,0.5) node[midway,sloped,above] {$x$};
\draw (2,-.5) -- (0,0) node[midway,sloped,below] {$y$};
\end{tikzpicture}
```

There exist styles for specifying positions a bit less “technically”:

`/tikz/midway`

(style, no value)

This has the same effect as `pos=0.5`.

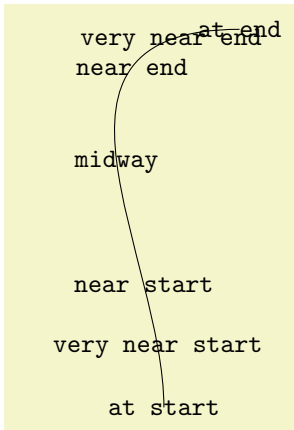

```
\tikz \draw (0,0) .. controls +(up:2cm) and +(left:3cm) .. (1,5)
node[at end] {|at end|}
node[very near end] {|very near end|}
node[near end] {|near end|}
node[midway] {|midway|}
node[near start] {|near start|}
node[very near start] {|very near start|}
node[at start] {|at start|};
```

`/tikz/near start`

(style, no value)

Set to `pos=0.25`.

`/tikz/near end`

(style, no value)

Set to `pos=0.75`.

`/tikz/very near start`

(style, no value)

Set to `pos=0.125`.

`/tikz/very near end`

(style, no value)

Set to `pos=0.875`.

`/tikz/at start`

(style, no value)

Set to `pos=0`.

`/tikz/at end`

(style, no value)

Set to `pos=1`.

## 16.9 Placing Nodes on a Line or Curve Implicitly

When you wish to place a node on the line  $(0,0) -- (1,1)$ , it is natural to specify the node not following the  $(1,1)$ , but “somewhere in the middle.” This is, indeed, possible and you can write  $(0,0) -- \text{node}{a} (1,1)$  to place a node midway between  $(0,0)$  and  $(1,1)$ .

What happens is the following: The syntax of the line-to path operation is actually `-- node<node specification><coordinate>`. (It is even possible to give multiple nodes in this way.) When the optional `node` is encountered, that is, when the `--` is directly followed by `node`, then the specification(s) are read and “stored away.” Then, after the `<coordinate>` has finally been reached, they are inserted again, but with the `pos` option set.

There are two things to note about this: When a node specification is “stored,” its catcodes become fixed. This means that you cannot use overly complicated verbatim text in them. If you really need, say, a verbatim text, you will have to put it in a normal node following the coordinate and add the `pos` option.

Second, which `pos` is chosen for the node? The position is inherited from the surrounding scope. However, this holds only for nodes specified in this implicit way. Thus, if you add the option `[near end]` to a scope, this does not mean that *all* nodes given in this scope will be put on near the end of lines. Only the nodes for which an implicit `pos` is added will be placed near the end. Typically, this is what you want. Here are some examples that should make this clearer:

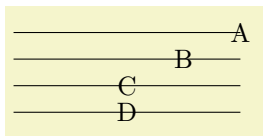

```
\begin{tikzpicture}[near end]
\draw (0cm,4em) -- (3cm,4em) node{A};
\draw (0cm,3em) --          node{B}          (3cm,3em);
\draw (0cm,2em) --          node[midway] {C} (3cm,2em);
\draw (0cm,1em) -- (3cm,1em) node[midway] {D} ;
\end{tikzpicture}
```

Like the line-to operation, the curve-to operation `..` also allows you to specify nodes “inside” the operation. After both the first `..` and also after the second `..` you can place node specifications. Like for the `--` operation, these will be collected and then reinserted after the operation with the `pos` option set.

## 16.10 The Label and Pin Options

In addition to the `node` path operation, nodes can also be added using the `label` and the `pin` option. This is mostly useful for simple nodes.

`/tikz/label=[<options>]<angle>:<text>` (no default)

When this option is given to a `node` operation, it causes *another* node to be added to the path after the current node has been finished. This extra node will have the text `<text>`. It is placed, in principle, in the direction `<angle>` relative to the main node, but the exact rules are a bit complex. Suppose the `node` currently under construction is called `main node` and let us call the label node `label node`. Then the following happens:

1. The `<angle>` is used to determine a position on the border of the `main node`. If the `<angle>` is missing, the value of the following key is used instead:

`/tikz/label position=<angle>` (no default, initially `above`)

Sets the default position for labels.

The `<angle>` determines the position on the border of the shape in two different ways. Normally, the border position is given by `main node.<angle>`. This means that the `<angle>` can either be a number like 0 or -340, but it can also be an anchor like `north`. Additionally, the special angles `above`, `below`, `left`, `right`, `above left`, and so on are automatically replaced by the corresponding angles 90, 270, 180, 0, 135, and so on.

A special case arises when the following key is set:

`/tikz/absolute=<true or false>` (default `true`)

When this key is set, the `<angle>` is interpreted differently: We still use a point on the border of the `main node`, but the angle is measured “absolutely,” that is, an angle of 0 refers to the point on the border that lies on a straight line from the `main node`’s center to the right (relative to the paper, not relative to the local coordinate system or either the node or the scope).

The difference can be seen in the following example:

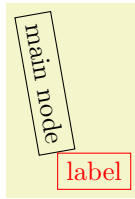

```
\tikz [rotate=-80, every label/.style={draw, red}]
\node [transform shape, rectangle, draw, label=right:label] {main node};
```

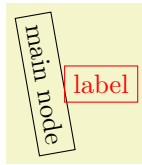

```
\tikz [rotate=-80, every label/.style={draw, red}, absolute]
\node [transform shape, rectangle, draw, label=right:label] {main node};
```

- Then, an anchor point for the `label` node. It is determined in such a way that the `label` node will “face away” from the border of the `main` node. The anchor that is chosen depends on the position of the border point that is chosen and its position relative to the center of the `main` node and on whether the `transform shape` option is set. In general, the choice should be what you would expect, but you may have to set the anchor yourself in difficult situations.

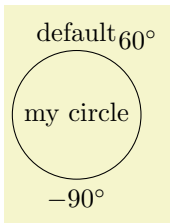

```
\tikz
\node [circle, draw,
label=default,
label=60:$60^\circ\text{circ}$,
label=below:$-90^\circ\text{circ}$] {my circle};
```

- One `<angle>` is special: If you set the `<angle>` to `center`, then the label will be placed on the center of the main node. This is mainly useful for adding a label text to an existing node, especially if it has been rotated.



```
\tikz \node [transform shape, rotate=90,
rectangle, draw, label={[red]center:R}] {main node};
```

You can pass `<options>` to the node `label` node. For this, you provide the options in square brackets before the `<angle>`. If you do so, you need to add braces around the whole argument of the `label` option and this is also the case if you have brackets or commas or semicolons or anything special in the `<text>`.

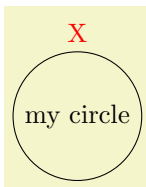

```
\tikz \node [circle, draw, label={[red]above:X}] {my circle};
```

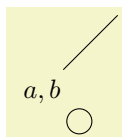

```
\begin{tikzpicture}
\node [circle, draw, label={[name=label node]above left:$a,b$}] {};
\draw (label node) -- +(1,1);
\end{tikzpicture}
```

If you provide multiple `label` options, then multiple extra label nodes are added in the order they are given.

The following styles influence how labels are drawn:



`/tikz/label distance=<distance>` (no default, initially 0pt)

The  $\langle distance \rangle$  is additionally inserted between the main node and the label node.

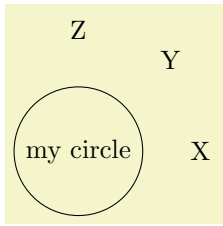

```
\tikz[label distance=5mm]
\node [circle,draw,label=right:X,
      label=above right:Y,
      label=above:Z] {my circle};
```

`/tikz/every label` (style, initially empty)

This style is used in every node created by the `label` option. The default is `draw=none,fill=none`.

`/tikz/pin=[<options>]<angle>:<text>` (no default)

This option is quite similar to the `label` option, but there is one difference: In addition to adding an extra node to the picture, it also adds an edge from this node to the main node. This causes the node to look like a pin that has been added to the main node:

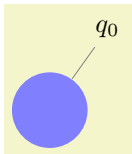

```
\tikz \node [circle,fill=blue!50,minimum size=1cm,pin=60:$q_0$] {};
```

The meaning of the  $\langle options \rangle$  and the  $\langle angle \rangle$  and the  $\langle text \rangle$  is exactly the same as for the `node` option. Only, the options and styles that influence the way pins look are different:

`/tikz/pin distance=<distance>` (no default, initially 3ex)

This  $\langle distance \rangle$  is used instead of the `label distance` for the distance between the main node and the label node.

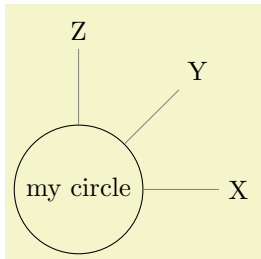

```
\tikz[pin distance=1cm]
\node [circle,draw,pin=right:X,
      pin=above right:Y,
      pin=above:Z] {my circle};
```

`/tikz/every pin` (style, initially `draw=none,fill=none`)

This style is used in every node created by the `pin` option.

`/tikz/pin position=<angle>` (no default, initially `above`)

The default pin position. Works like `label position`.

`/tikz/every pin edge` (style, initially `help lines`)

This style is used in every edge created by the `pin` options.

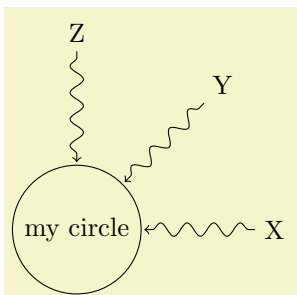

```
\tikz [pin distance=15mm,
      every pin edge/.style={<- ,shorten <=1pt,decorate,
      decoration={snake,pre length=4pt}}]
\node [circle,draw,pin=right:X,
      pin=above right:Y,
      pin=above:Z] {my circle};
```

`/tikz/pin edge=<options>`

(no default, initially empty)

This option can be used to set the options that are to be used in the edge created by the `pin` option.

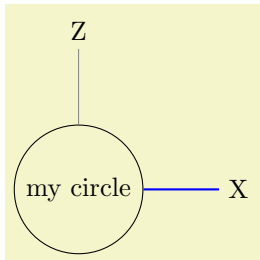

```
\tikz[pin distance=10mm]
\node [circle,draw,pin={[pin edge={blue,thick}]right:X},
      pin=above:Z] {my circle};
```

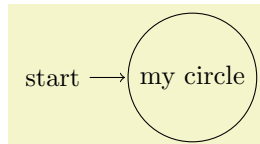

```
\tikz [every pin edge/.style={},
       initial/.style={pin={[pin distance=5mm,
                             pin edge={<,shorten <=1pt}]left:start}}]
\node [circle,draw,initial] {my circle};
```

## 16.11 Connecting Nodes: Using Nodes as Coordinates

Once you have defined a node and given it a name, you can use this name to reference it. This can be done in two ways, see also Section 13.2.3. Suppose you have said `\path(0,0) node(x) {Hello World!};` in order to define a node named `x`.

1. Once the node `x` has been defined, you can use `(x.<anchor>)` wherever you would normally use a normal coordinate. This will yield the position at which the given `<anchor>` is in the picture. Note that transformations do not apply to this coordinate, that is, `(x.north)` will be the northern anchor of `x` even if you have said `scale=3` or `xshift=4cm`. This is usually what you would expect.
2. You can also just use `(x)` as a coordinate. In most cases, this gives the same coordinate as `(x.center)`. Indeed, if the `shape` of `x` is `coordinate`, then `(x)` and `(x.center)` have exactly the same effect.

However, for most other shapes, some path construction operations like `--` try to be “clever” when this they are asked to draw a line from such a coordinate or to such a coordinate. When you say `(x)--(1,1)`, the `--` path operation will not draw a line from the center of `x`, but *from the border* of `x` in the direction going towards `(1,1)`. Likewise, `(1,1)--(x)` will also have the line end on the border in the direction coming from `(1,1)`.

In addition to `--`, the curve-to path operation `..` and the path operations `-|` and `|-` will also handle nodes without anchors correctly. Here is an example, see also Section 13.2.3:

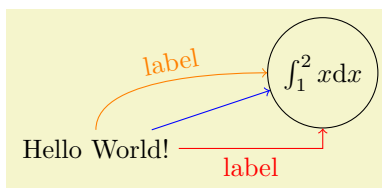

```
\begin{tikzpicture}
\path (0,0) node (x) {Hello World!}
      (3,1) node[circle,draw](y) {$\int_1^2 x \mathrm{d} x$};

\draw[->,blue] (x) -- (y);
\draw[->,red] (x) -| node[near start,below] {label} (y);
\draw[->,orange] (x) .. controls +(up:1cm) and +(left:1cm) .. node[above,sloped] {label} (y);
\end{tikzpicture}
```

## 16.12 Connecting Nodes: Using the Edge Operation

The `edge` operation works like a `to` operation that is added after the main path has been drawn, much like a node is added after the main path has been drawn. This allows you to have each `edge` to have a different appearance. As the `node` operation, an `edge` temporarily suspends the construction of the current path and

a new path  $p$  is constructed. This new path  $p$  will be drawn after the main path has been drawn. Note that  $p$  can be totally different from the main path with respect to its options. Also note that if there are several `to` and/or `node` operations in the main path, each creates its own path(s) and they are drawn in the order that they are encountered on the path.

```
\path ... edge[options] (nodes) ((coordinate)) ...;
```

The effect of the `edge` operation is that after the main path the following path is added to the picture:

```
\path[every edge,options] (\tikztostart) <path>;
```

Here,  $\langle path \rangle$  is the `to path`. Note that, unlike the path added by the `to` operation, the  $\langle \tikztostart \rangle$  is added before the  $\langle path \rangle$  (which is unnecessary for the `to` operation, since this coordinate is already part of the main path).

The  $\langle \tikztostart \rangle$  is the last coordinate on the path just before the `edge` operation, just as for the `node` or `to` operations. However, there is one exception to this rule: If the `edge` operation is directly preceded by a `node` operation, then this just-declared node is the start coordinate (and not, as would normally be the case, the coordinate where this just-declared node is placed – a small, but subtle difference). In this regard, `edge` differs from both `node` and `to`.

If there are several `edge` operations in a row, the start coordinate is the same for all of them as their target coordinates are not, after all, part of the main path. The start coordinate is, thus, the coordinate preceding the first `edge` operation. This is similar to `nodes` insofar as the `edge` operation does not modify the current path at all. In particular, it does not change the last coordinate visited, see the following example:

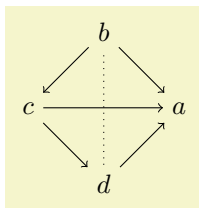

```
\begin{tikzpicture}
  \node (a) at (0:1) {$a$};
  \node (b) at (90:1) {$b$} edge [->] (a);
  \node (c) at (180:1) {$c$} edge [->] (a);
  \node (d) at (270:1) {$d$} edge [->] (a);
  edge [->] (b);
  edge [dotted] (b);
  edge [->] (c);
\end{tikzpicture}
```

A different way of specifying the above graph using the `edge` operation is the following:

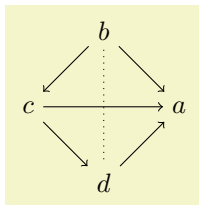

```
\begin{tikzpicture}
  \foreach \name/\angle in {a/0,b/90,c/180,d/270}
    \node (\name) at (\angle:1) {$\name$};

  \path[->] (b) edge (a)
             edge (c)
             edge [-,dotted] (d)
             (c) edge (a)
             edge (d)
             (d) edge (a);
\end{tikzpicture}
```

As can be seen, the path of the `edge` operation inherits the options from the main path, but you can locally overrule them.

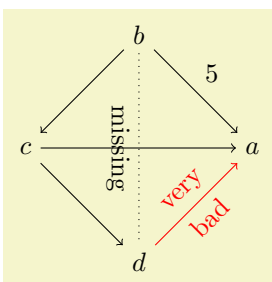

```
\begin{tikzpicture}
  \foreach \name/\angle in {a/0,b/90,c/180,d/270}
    \node (\name) at (\angle:1.5) {$\name$};

  \path[->] (b) edge node[above right] {$5$} (a)
             edge (c)
             edge [-,dotted] node[below,sloped] {missing} (d)
             (c) edge (a)
             edge (d)
             (d) edge [red] node[above,sloped] {very}
                   node[below,sloped] {bad} (a);
\end{tikzpicture}
```

Instead of `every to`, the style `every edge` is installed at the beginning of the main path.

`/tikz/every edge (initially draw)` (style, no value)

Executed for each `edge`.



```
\begin{tikzpicture}[every to/.style={draw,dashed}]
  \path (0,0) to (3,2);
\end{tikzpicture}
```

## 16.13 Referencing Nodes Outside the Current Pictures

### 16.13.1 Referencing a Node in a Different Picture

It is possible (but not quite trivial) to reference nodes in pictures other than the current one. This means that you can create a picture and a node therein and, later, you can draw a line from some other position to this node.

To reference nodes in different pictures, proceed as follows:

1. You need to add the `remember picture` option to all pictures that contain nodes that you wish to reference and also to all pictures from which you wish to reference a node in another picture.
2. You need to add the `overlay` option to paths or to whole pictures that contain references to nodes in different pictures. (This option switches the computation of the bounding box off.)
3. You need to use a driver that supports picture remembering and you need to run  $\text{\TeX}$  twice.

(For more details on what is going on behind the scenes, see Section 75.3.2.)

Let us have a look at the effect of these options.

`/tikz/remember picture`=*<boolean>* (no default, initially `false`)

This option tells *TikZ* that it should attempt to remember the position of the current picture on the page. This attempt may fail depending on which backend driver is used. Also, even if remembering works, the position may only be available on a second run of  $\text{\TeX}$ .

Provided that remembering works, you may consider saying

```
\tikzstyle{every picture}+=[remember picture]
```

to make *TikZ* remember all pictures. This will add one line in the `.aux` file for each picture in your document – which typically is not very much. Then, you do not have to worry about remembered pictures at all.

`/tikz/overlay` (no value)

This option is mainly intended for use when nodes in other pictures are referenced, but you can also use it in other situations. The effect of this option is that everything within the current scope is not taken into consideration when the bounding box of the current picture is computed.

You need to specify this option on all paths (or at least on all parts of paths) that contain a reference to a node in another picture. The reason is that, otherwise, *TikZ* will attempt to make the current picture large enough to encompass *the node in the other picture*. However, on a second run of  $\text{\TeX}$  this will create an even bigger picture, leading to larger and larger pictures. Unless you know what you are doing, I suggest specifying the `overlay` option with all pictures that contain references to other pictures.

Let us now have a look at a few examples. These examples work only if this document is processed with a driver that supports picture remembering.

Inside the current text we place two pictures, containing nodes named `n1` and `n2`, using

```
\tikz[remember picture] \node[fill=red!50] (n1) {};
```

which yields , and

```
\tikz[remember picture] \node[fill=blue!50] (n2) {};
```

yielding the node . To connect these nodes, we create another picture using the `overlay` option and also the `remember picture` option.

```
\begin{tikzpicture}[remember picture,overlay]
\draw[->,very thick] (n1) -- (n2);
\end{tikzpicture}
```

Note that the last picture is seemingly empty. What happens is that it has zero size and contains an arrow that lies well outside its bounds. As a last example, we connect a node in another picture to the first two nodes. Here, we provide the `overlay` option only with the line that we do not wish to count as part of the picture.

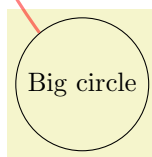

```
\begin{tikzpicture}[remember picture]
\node (c) [circle,draw] {Big circle};

\draw [overlay,->,very thick,red,opacity=.5]
(c) to[bend left] (n1) (n1) -| (n2);
\end{tikzpicture}
```

### 16.13.2 Referencing the Current Page Node – Absolute Positioning

There is a special node called `current page` that can be used to access the current page. It is a node of shape rectangle whose `south west` anchor is the lower left corner of the page and whose `north east` anchor is the upper right corner of the page. While this node is handled in a special way internally, you can reference it as if it were defined in some remembered picture other than the current one. Thus, by giving the `remembered picture` and the `overlay` options to a picture, you can position nodes *absolutely* on a page.

The first example places some text in the lower left corner of the current page:

```
\begin{tikzpicture}[remember picture,overlay]
\node [xshift=1cm,yshift=1cm] at (current page.south west)
[text width=7cm,fill=red!20,rounded corners,above right]
{
This is an absolutely positioned text in the
lower left corner. No shipout-hackery is used.
};
\end{tikzpicture}
```

The next example adds a circle in the middle of the page.

```
\begin{tikzpicture}[remember picture,overlay]
\draw [line width=1mm,opacity=.25]
(current page.center) circle (3cm);
\end{tikzpicture}
```

The final example overlays some text over the page (depending on where this example is found on the page, the text may also be behind the page).

```
\begin{tikzpicture}[remember picture,overlay]
\node [rotate=60,scale=10,text opacity=0.2]
at (current page.center) {Example};
\end{tikzpicture}
```

## 16.14 Late Code and Late Options

All options given to a node only locally affect this one node. While this is a blessing in most cases, you may sometimes want to cause options to have effects “later” on. The other way round, you may sometimes note “only later” that some options should be added to the options of a node.

As explained in Section 14, you can use the options `append after command` and `prefix after command` to add a path after a node. The following macro may be useful there:

This is an absolutely positioned text in the lower left corner. No shipout-hackery is used.

## `\tikzlastnode`

Expands to the last node on the path.

A *late option* for a node is an option that is given a long time after the node has already been constructed.

`/tikz/late options=<options>` (no default)

This option can be given on a path (but not as an argument to a `node` path command). It has the following effect: An already *existing node* is determined (in a way to be described in a moment) and, then, the *options* are executed in a local scope. Most of these options will have no effect since you *cannot change the appearance of the node*, that is, you cannot change a red node into a green node using late options. However, giving the the `append after command` and `prefix after command` options inside the *options* (directly or indirectly) does have the desired effect: The given path gets executed with the `\tikzlastnode` set to the determined node.

The net effect of all this is that you can provide, say, the `label` option inside the *options* to add a label to a node that has already been constructed. Likewise, you can use the `on chain` option to make an already *existing node* part of a chain.

The *existing node* is determined as follows: If the `name=<existing node>` option is used inside the *options*, then this name is used. Otherwise, if the last coordinate on the current path was of the form (*existing node*), then this *existing node* name is used. Otherwise, an error results.



```
\begin{tikzpicture}
  \node (a) [draw,circle] {Hello};
  \path (a) [late options={label=above:world}];
\end{tikzpicture}
```

## 17 Matrices and Alignment

### 17.1 Overview

When creating pictures, one often faces the problem of correctly aligning parts of the picture. For example, you might wish that the base lines of certain nodes should be on the same line and some further nodes should be below these nodes with, say, their centers on a vertical lines. There are different ways of solving such problems. For example, by making clever use of anchors, nearly all such alignment problems can be solved. However, this often leads to complicated code. An often simpler way is to use *matrices*, the use of which is explained in the current section.

A TikZ matrix is similar to L<sup>A</sup>T<sub>E</sub>X's `{tabular}` or `{array}` environment, only instead of text each cell contains a little picture or a node. The sizes of the cells are automatically adjusted such that they are large enough to contain all the cell contents.

Matrices are a powerful tool and they need to be handled with some care. For impatient readers who skip the rest of this section: you *must* end *every* row with `\\`. In particular, the last row *must* be ended with `\\`.

Many of the ideas implemented in TikZ's matrix support are due to Mark Wibrow – many thanks to Mark at this point!

### 17.2 Matrices are Nodes

Matrices are special in many ways, but for most purposes matrices are treated like nodes. This means, that you use the `node` path command to create a matrix and you only use a special option, namely the `matrix` option, to signal that the node will contain a matrix. Instead of the usual T<sub>E</sub>X-box that makes up the `text` part of the node's shape, the matrix is used. Thus, in particular, a matrix can have a shape, this shape can be drawn or filled, it can be used in a tree, and so on. Also, you can refer to the different anchors of a matrix.

`/tikz/matrix=<true or false>` (default `true`)

This option can be passed to a node path command. It signals that the node will contain a matrix.

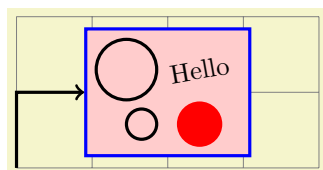

```
\begin{tikzpicture}
\draw[help lines] (0,0) grid (4,2);
\node [matrix,fill=red!20,draw=blue,very thick] (my matrix) at (2,1)
{
\draw (0,0) circle (4mm); & \node[rotate=10] {Hello}; \\
\draw (0.2,0) circle (2mm); & \fill[red] (0,0) circle (3mm); \\
};

\draw [very thick,->] (0,0) |- (my matrix.west);
\end{tikzpicture}
```

The exact syntax of the matrix is explained in the course of this section.

`/tikz/every matrix` (style, initially empty)

This style is used in every matrix.

Even more so than nodes, matrices will often be the only object on a path. Because of this, there is a special abbreviation for creating matrices:

`\matrix`

Inside `{tikzpicture}` this is an abbreviation for `\path node[matrix]`.

Even though matrices are nodes, some options do not have the same effect as for normal nodes:

1. Rotations and scaling have no effect on a matrix as a whole (however, you can still transform the contents of the cells normally). Before the matrix is typeset, the rotational and scaling part of the transformation matrix is reset.
2. For multi-part shapes you can only set the `text` part of the node.
3. All options starting with `text` such as `text width` have no effect.

## 17.3 Cell Pictures

A matrix consists of rows of *cells*. Each row (including the last one!) is ended by the command `\`. The character `&` is used to separate cells. Inside each cell, you must place commands for drawing a picture, called the *cell picture* in the following. (However, cell pictures are not enclosed in a complete `{pgfpicture}` environment, they are a bit more light-weight. The main difference is that cell pictures cannot have layers.) It is not necessary to specify beforehand how many rows or columns there are going to be and if a row contains less cell pictures than another line, empty cells are automatically added as needed.

### 17.3.1 Alignment of Cell Pictures

For each cell picture a bounding box is computed. These bounding boxes and the origins of the cell pictures determine how the cells are aligned. Let us start with the rows: Consider the cell pictures on the first row. Each has a bounding box and somewhere inside this bounding box the origin of the cell picture can be found (the origin might even lie outside the bounding box, but let us ignore this problem for the moment). The cell pictures are then shifted around such that all origins lie on the same horizontal line. This may make it necessary to shift some cell pictures upwards and other downwards, but it can be done and this yields the vertical alignment of the cell pictures this row. The top of the row is then given by the top of the “highest” cell picture in the row, the bottom of the row is given by the bottom of the lowest cell picture. (To be more precise, the height of the row is the maximum  $y$ -value of any of the bounding boxes and the depth of the row is the negated minimum  $y$ -value of the bounding boxes).

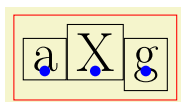

```
\begin{tikzpicture}
  [every node/.style={draw=black,anchor=base,font=\huge}]

  \matrix [draw=red]
  {
    \node {a}; \fill[blue] (0,0) circle (2pt); &
    \node {X}; \fill[blue] (0,0) circle (2pt); &
    \node {g}; \fill[blue] (0,0) circle (2pt); \\
  };
\end{tikzpicture}
```

Each row is aligned in this fashion: For each row the cell pictures are vertically aligned such that the origins lie on the same line. Then the second row is placed below the first row such that the bottom of the first row touches the top of the second row (unless a `row sep` is used to add a bit of space). Then the bottom of the second row touches the top of the third row, and so on. Typically, each row will have an individual height and depth.

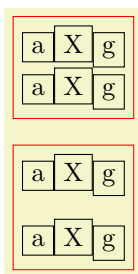

```
\begin{tikzpicture}
  [every node/.style={draw=black,anchor=base}]

  \matrix [draw=red]
  {
    \node {a}; & \node {X}; & \node {g}; \\
    \node {a}; & \node {X}; & \node {g}; \\
  };

  \matrix [row sep=3mm,draw=red] at (0,-2)
  {
    \node {a}; & \node {X}; & \node {g}; \\
    \node {a}; & \node {X}; & \node {g}; \\
  };
\end{tikzpicture}
```

Let us now have a look at the columns. The rules for how the pictures on any given column are aligned are very similar to the row alignment: Consider all cell pictures in the first column. Each is shifted horizontally such that the origins lie on the same vertical line. Then, the left end of the column is at the left end of the bounding box that protrudes furthest to the left. The right end of the column is at the right end of the bounding box that protrudes furthest to the left. This fixes the horizontal alignment of the cell pictures in the first column and the same happens the cell pictures in the other columns. Then, the right end of the first column touches the left end of the second column (unless `column sep` is used). The right end of the second column touches the left end of the third column, and so on. (Internally, two columns are actually used to achieve the desired horizontal alignment, but that is only an implementation detail.)



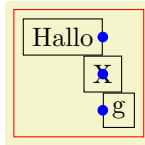

```
\begin{tikzpicture}[every node/.style={draw}]
\matrix [draw=red]
{
\node[left] {Hallo}; \fill[blue] (0,0) circle (2pt); \\
\node {X}; \fill[blue] (0,0) circle (2pt); \\
\node[right] {g}; \fill[blue] (0,0) circle (2pt); \\
};
\end{tikzpicture}
```

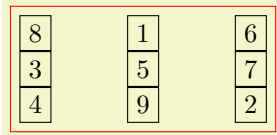

```
\begin{tikzpicture}[every node/.style={draw}]
\matrix [draw=red,column sep=1cm]
{
\node {8}; & \node {1}; & \node {6}; \\
\node {3}; & \node {5}; & \node {7}; \\
\node {4}; & \node {9}; & \node {2}; \\
};
\end{tikzpicture}
```

### 17.3.2 Setting and Adjusting Column and Row Spacing

There are different ways of setting and adjusting the spacing between columns and rows. First, you can use the options `column sep` and `row sep` to set a default spacing for all rows and all columns. Second, you can add options to the `&` character and the `\node` command to adjust the spacing between two specific columns or rows. Additionally, you can specify whether the space between two columns or rows should be considered between the origins of cells in the column or row or between their borders.

`/tikz/column sep=<spacing list>` (no default)

This option sets a default space that is added between every two columns. This space can be positive or negative and is zero by default. The `<spacing list>` normally contains a single dimension like `2pt`.

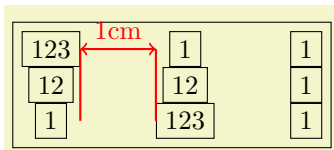

```
\begin{tikzpicture}
\matrix [draw,column sep=1cm,nodes=draw]
{
\node(a) {123}; & \node (b) {1}; & \node {1}; \\
\node {12}; & \node {12}; & \node {1}; \\
\node(c) {1}; & \node (d) {123}; & \node {1}; \\
};
\draw [red,thick] (a.east) -- (a.east |- c)
(d.west) -- (d.west |- b);
\draw [red,thick] (a.east) -- (d.west |- b)
node [above,midway] {1cm};
\end{tikzpicture}
```

More generally, the `<spacing list>` may contain a whole list of numbers, separated by commas, and occurrences of the two key words `between origins` and `between borders`. The effect of specifying such a list is the following: First, all numbers occurring in the list are simply added to compute the final spacing. Second, concerning the two keywords, the last occurrence of one of the keywords is important. If the last occurrence is `between borders` or if neither occurs, then the space is inserted between the two columns normally. However, if the last occurs is `between origins`, then the following happens: The distance between the columns is adjusted such that the difference between the origins of all the cells in the first column (remember that they all lie on straight line) and the origins of all the cells in the second column is exactly the given distance.

*The `between origins` option can only be used for columns mentioned in the first row, that is, you cannot specify this option for columns introduced only in later rows.*

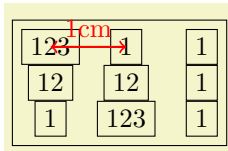

```
\begin{tikzpicture}
\matrix [draw,column sep={1cm,between origins},nodes=draw]
{
\node(a) {123}; & \node (b) {1}; & \node {1}; \\
\node {12}; & \node {12}; & \node {1}; \\
\node {1}; & \node {123}; & \node {1}; \\
};
\draw [<->,red,thick] (a.center) -- (b.center) node [above,midway] {1cm};
\end{tikzpicture}
```

`/tikz/row sep=<spacing list>` (no default)

This option works like `column sep`, only for rows. Here, too, you can specify whether the space is added between the lower end of the first row and the upper end of the second row, or whether the space is computed between the origins of the two rows.

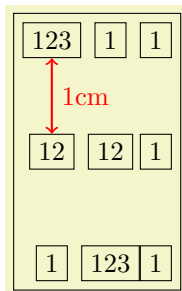

```
\begin{tikzpicture}
\matrix [draw,row sep=1cm,nodes=draw]
{
\node (a) {123}; & \node {1}; & \node {1}; \\
\node (b) {12}; & \node {12}; & \node {1}; \\
\node {1}; & \node {123}; & \node {1}; \\
};
\draw [<->,red,thick] (a.south) -- (b.north) node [right,midway] {1cm};
\end{tikzpicture}
```

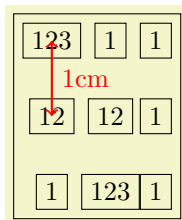

```
\begin{tikzpicture}
\matrix [draw,row sep={1cm,between origins},nodes=draw]
{
\node (a) {123}; & \node {1}; & \node {1}; \\
\node (b) {12}; & \node {12}; & \node {1}; \\
\node {1}; & \node {123}; & \node {1}; \\
};
\draw [<->,red,thick] (a.center) -- (b.center) node [right,midway] {1cm};
\end{tikzpicture}
```

The row-end command `\` allows you to provide an optional argument, which must be a dimension. This dimension will be added to the list in `row sep`. This means that, firstly, any numbers you list in this argument will be added as an extra row separation between the line being ended and the next line and, secondly, you can use the keywords `between origins` and `between borders` to locally overrule the standard setting for this line pair.

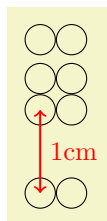

```
\begin{tikzpicture}
\matrix [row sep=1mm]
{
\draw (0,0) circle (2mm); & \draw (0,0) circle (2mm); \\
\draw (0,0) circle (2mm); & \draw (0,0) circle (2mm); \\
\draw (0,0) coordinate (a) circle (2mm); & \\
\draw (0,0) circle (2mm); & \draw [1cm,between origins] \\
\draw (0,0) coordinate (b) circle (2mm); & \\
\draw (0,0) circle (2mm); & \\
};
\draw [<->,red,thick] (a.center) -- (b.center) node [right,midway] {1cm};
\end{tikzpicture}
```

The cell separation character `&` also takes an optional argument, which must also be a spacing list. This spacing list is added to the `column sep` having a similar effect as the option for the `\` command for rows.

This optional spacing list can only be given the first time a new column is started (usually in the first row), subsequent usages of this option in later rows have no effect.

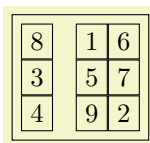

```
\begin{tikzpicture}
\matrix [draw,nodes=draw,column sep=1mm]
{
\node {8}; & [2mm] \node{1}; & [-1mm] \node {6}; \\
\node {3}; & \node{5}; & \node {7}; \\
\node {4}; & \node{9}; & \node {2}; \\
};
\end{tikzpicture}
```

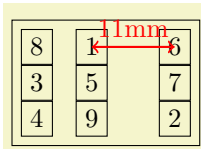

```
\begin{tikzpicture}
\matrix [draw,nodes=draw,column sep=1mm]
{
\node {8}; & [2mm] \node(a){1}; & [1cm,between origins] \node(b){6}; \\
\node {3}; & \node {5}; & \node {7}; \\
\node {4}; & \node {9}; & \node {2}; \\
};
\draw [<->,red,thick] (a.center) -- (b.center) node [above,midway] {11mm};
\end{tikzpicture}
```

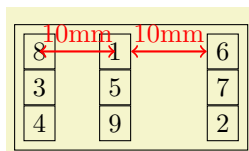

```
\begin{tikzpicture}
\matrix [draw,nodes=draw,column sep={1cm,between origins}]
{
\node (a) {8}; & \node (b) {1}; & [between borders] \node (c) {6}; \\
\node {3}; & \node {5}; & \node {7}; \\
\node {4}; & \node {9}; & \node {2}; \\
};
\draw [<->,red,thick] (a.center) -- (b.center) node [above,midway] {10mm};
\draw [<->,red,thick] (b.east) -- (c.west) node [above,midway] {10mm};
\end{tikzpicture}
```

### 17.3.3 Cell Styles and Options

For following style and option are useful for changing the appearance of the all cell pictures:

**/tikz/every cell**={*<row>*}{*<column>*} (style, no default, initially empty)

This style is installed at the beginning of each cell picture with the two parameters being the current *<row>* and *<column>* of the cell. Note that setting this style to **draw** will *not* cause all nodes to be drawn since the **draw** option has to be passed to each node individually.

Inside this style (and inside all cells), the current *<row>* and *<column>* number are also accessible via the counters `\pgfmatrixcurrentrow` and `\pgfmatrixcurrentcolumn`.

**/tikz/cells**=*<options>* (no default)

This key adds the *<options>* to the style **every cell**. It mainly just a shorthand for the code `every cell/.append style=<options>`.

**/tikz/nodes**=*<options>* (no default)

This key adds the *<options>* to the style **every node**. It mainly just a shorthand for the code `every node/.append style=<options>`.

The main use of this option is the install some options for the nodes *inside* the matrix that should not apply to the matrix *itself*.

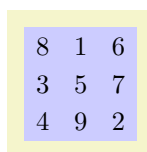

```
\begin{tikzpicture}
\matrix [nodes={fill=blue!20,minimum size=5mm}]
{
\node {8}; & \node{1}; & \node {6}; \\
\node {3}; & \node{5}; & \node {7}; \\
\node {4}; & \node{9}; & \node {2}; \\
};
\end{tikzpicture}
```

The next set of styles can be used to change the appearance of certain rows, columns, or cells. If more than one of these styles is defined, they are executed in the below order (the **every cell** style is executed before all of the below).

**/tikz/column** *<number>* (style, no value)

This style is used for every cell in column *<number>*.

**/tikz/every odd column** (style, no value)

This style is used for every cell in an odd column.

**/tikz/every even column** (style, no value)

This style is used for every cell in an even column.

`/tikz/row <number>` (style, no value)

This style is used for every cell in row *<number>*.

`/tikz/every odd row` (style, no value)

This style is used for every cell in an odd row.

`/tikz/every even row` (style, no value)

This style is used for every cell in an even row.

`/tikz/row <row number> column <column number>` (style, no value)

This style is used for the cell in row *<row number>* and column *<column number>*.

|                              |                                                                                                                                                                                                                                                                                                          |
|------------------------------|----------------------------------------------------------------------------------------------------------------------------------------------------------------------------------------------------------------------------------------------------------------------------------------------------------|
| <pre>8 1 6 3 5 7 4 9 2</pre> | <pre>\begin{tikzpicture} [ row 1/.style={red},   column 2/.style={green!50!black},   row 3 column 3/.style={blue}]  \matrix { \node {8}; &amp; \node {1}; &amp; \node {6}; \\ \node {3}; &amp; \node {5}; &amp; \node {7}; \\ \node {4}; &amp; \node {9}; &amp; \node {2}; \\ }; \end{tikzpicture}</pre> |
|------------------------------|----------------------------------------------------------------------------------------------------------------------------------------------------------------------------------------------------------------------------------------------------------------------------------------------------------|

You can use the `column <number>` option to change the alignment for different columns.

|                                               |                                                                                                                                                                                                                                                                                                                                     |
|-----------------------------------------------|-------------------------------------------------------------------------------------------------------------------------------------------------------------------------------------------------------------------------------------------------------------------------------------------------------------------------------------|
| <pre>123 456 789 12   45  78 1    4   7</pre> | <pre>\begin{tikzpicture} [ column 1/.style={anchor=base west},   column 2/.style={anchor=base east},   column 3/.style={anchor=base}] \matrix { \node {123}; &amp; \node {456}; &amp; \node {789}; \\ \node {12}; &amp; \node {45}; &amp; \node {78}; \\ \node {1}; &amp; \node {4}; &amp; \node {7}; \\ }; \end{tikzpicture}</pre> |
|-----------------------------------------------|-------------------------------------------------------------------------------------------------------------------------------------------------------------------------------------------------------------------------------------------------------------------------------------------------------------------------------------|

In many matrices all cell pictures have nearly the same code. For example, cells typically start with `\node{` and end `};`. The following options allow you to execute such code in all cells:

`/tikz/execute at begin cell=<code>` (no default)

The code will be executed at the beginning of each nonempty cell.

`/tikz/execute at end cell=<code>` (no default)

The code will be executed at the end of each nonempty cell.

`/tikz/execute at empty cell=<code>` (no default)

The code will be executed inside each empty cell.

|                              |                                                                                                                                                                                                                                                    |
|------------------------------|----------------------------------------------------------------------------------------------------------------------------------------------------------------------------------------------------------------------------------------------------|
| <pre>8 1 6 3 5 7 4 9 2</pre> | <pre>\begin{tikzpicture} [ matrix of nodes/.style={   execute at begin cell=\node\bgroup,   execute at end cell=\egroup;% }] \matrix [matrix of nodes] { 8 &amp; 1 &amp; 6 \\ 3 &amp; 5 &amp; 7 \\ 4 &amp; 9 &amp; 2 \\ }; \end{tikzpicture}</pre> |
|------------------------------|----------------------------------------------------------------------------------------------------------------------------------------------------------------------------------------------------------------------------------------------------|

|   |   |   |
|---|---|---|
| 8 | 1 | - |
| 3 | - | 7 |
| - | - | 2 |

```
\begin{tikzpicture}
  [matrix of nodes/.style={
    execute at begin cell=\node\bgroup,
    execute at end cell=\egroup;%
    execute at empty cell=\node{--};%
  }]
  \matrix [matrix of nodes]
  {
    8 & 1 & \\\
    3 & & 7 \\\
    & & 2 \\\
  };
\end{tikzpicture}
```

The `matrix` library defines a number of styles that make use of the above options.

### 17.4 Anchoring a Matrix

Since matrices are nodes, they can be anchored in the usual fashion using the `anchor` option. However, there are two ways to influence this placement further. First, the following option is often useful:

`/tikz/matrix anchor=<anchor>` (no default)

This option has the same effect as `anchor`, but the option applies only to the matrix itself, not to the cells inside. If you just say `anchor=north` as an option to the matrix node, all nodes inside matrix will also have this anchor, unless it is explicitly set differently for each node. By comparison, `matrix anchor` sets the anchor for the matrix, but for the nodes inside the value of `anchor` remain unchanged.

|     |
|-----|
| 123 |
| 12  |
| 1   |
| 123 |
| 12  |
| 1   |

```
\begin{tikzpicture}
  \matrix [matrix anchor=west] at (0,0)
  {
    \node {123}; \\\ % still center anchor
    \node {12}; \\\
    \node {1}; \\\
  };
  \matrix [anchor=west] at (0,-2)
  {
    \node {123}; \\\ % inherited west anchor
    \node {12}; \\\
    \node {1}; \\\
  };
\end{tikzpicture}
```

The second way to anchor a matrix is to use *an anchor of a node inside the matrix*. For this, the `anchor` option has a special effect when given as an argument to a matrix:

`/tikz/anchor=<anchor or node.anchor>` (no default)

Normally, the argument of this option refers to anchor of the matrix node, which is the node than includes all of the stuff of the matrix. However, you can also provide an argument of the form `<node>.<anchor>` where `<node>` must be node defined inside the matrix and `<anchor>` is an anchor of this node. In this case, the whole matrix is shifted around in such a way that this particular anchor of this particular node lies at the `at` position of the matrix. The same is true for `matrix anchor`.

|   |   |   |   |  |
|---|---|---|---|--|
| a | b | c | d |  |
| a | b | c | d |  |
| a | b | c | d |  |

```
\begin{tikzpicture}
  \draw[help lines] (0,0) grid (3,2);
  \matrix[matrix anchor=inner node.south,anchor=base,row sep=3mm] at (1,1)
  {
    \node {a}; & \node {b}; & \node {c}; & \node {d}; \\\
    \node {a}; & \node(inner node) {b}; & \node {c}; & \node {d}; \\\
    \node {a}; & \node {b}; & \node {c}; & \node {d}; \\\
  };
  \draw (inner node.south) circle (1pt);
\end{tikzpicture}
```

## 17.5 Considerations Concerning Active Characters

Even though TikZ seems to use `&` to separate cells, PGF actually uses a different command to separate cells, namely the command `\pgfmatrixnextcell` and using a normal `&` character will normally fail. What happens is that, TikZ makes `&` an active character and then defines this character to be equal to `\pgfmatrixnextcell`. In most situations this will work nicely, but sometimes `&` cannot be made active; for instance because the matrix is used in an argument of some macro or the matrix contains nodes that contain normal `{tabular}` environments. In this case you can use the following option to avoid having to type `\pgfmatrixnextcell` each time:

`/tikz/ampersand replacement=<macro name or empty>` (no default)

If a macro name is provided, this macro will be defined to be equal to `\pgfmatrixnextcell` inside matrices and `&` will not be made active. For instance, you could say `ampersand replacement=\&` and then use `&` to separate columns as in the following example:

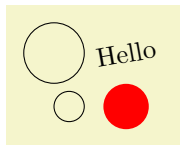

```
\tikz
\matrix [ampersand replacement=\&]
{
\draw (0,0) circle (4mm); \& \node[rotate=10] {Hello}; && \\
\draw (0.2,0) circle (2mm); \& \fill[red] (0,0) circle (3mm); && \\
};
```

## 17.6 Examples

The following examples are adapted from code by Mark Wibrow. The first two redraw pictures from Timothy van Zandt's PSTricks documentation:

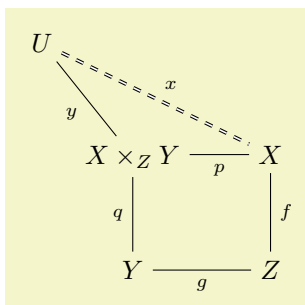

```
\begin{tikzpicture}
\matrix [matrix of math nodes,row sep=1cm]
{
|(U)| U & [2mm] & & [8mm] & \\
& |(XZY)| X \times_Z Y & & |(X)| X & \\
& |(Y)| Y & & |(Z)| Z & \\
};
\begin{scope}[every node/.style={midway,auto,font=\scriptsize}]
\draw [double, dashed] (U) -- node {$x$} (X);
\draw (X) -- node {$p$} (X -| XZY.east)
(X) -- node {$f$} (Z)
-- node {$g$} (Y)
-- node {$q$} (XZY)
-- node {$y$} (U);
\end{scope}
\end{tikzpicture}
```

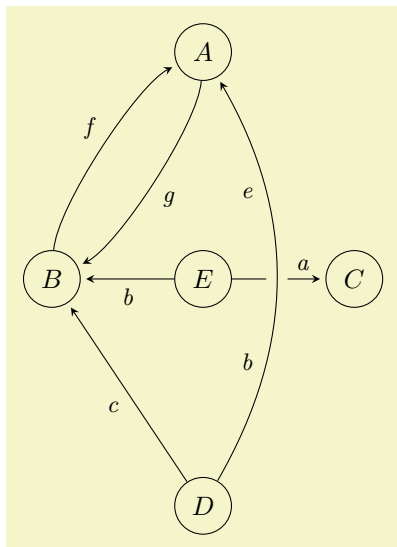

```

\begin{tikzpicture}[>=stealth,->,shorten >=2pt,looseness=.5,auto]
  \matrix [matrix of math nodes,
    column sep={2cm,between origins},
    row sep={3cm,between origins},
    nodes={circle, draw, minimum size=7.5mm}]
  {
    & |(A)| A & & \\
    |(B)| B & |(E)| E & |(C)| C & \\
    & |(D)| D & & \\
  };
  \begin{scope}[every node/.style={font=\small\itshape}]
    \draw (A) to [bend left] node [midway] {g} (B);
    \draw (B) to [bend left] node [midway] {f} (A);
    \draw (D) -- node [midway] {c} (B);
    \draw (E) -- node [midway] {b} (B);
    \draw (E) -- node [near end] {a} (C);
    \draw [-,line width=8pt,draw=graphicbackground]
      (D) to [bend right, looseness=1] (A);
    \draw (D) to [bend right, looseness=1]
      node [near start] {b} node [near end] {e} (A);
  \end{scope}
\end{tikzpicture}

```

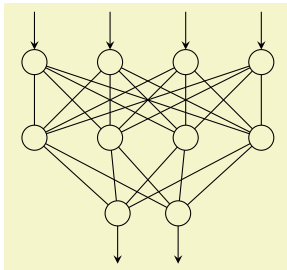

```

\begin{tikzpicture}
  \matrix (network)
  [matrix of nodes,%
  nodes in empty cells,
  nodes={outer sep=0pt,circle,minimum size=4pt,draw},
  column sep={1cm,between origins},
  row sep={1cm,between origins}]
  {
    & & & & \\
    & & & & \\
    |[draw=none]| & |[xshift=1mm]| & & |[xshift=-1mm]| & \\
  };
  \foreach \a in {1,...,4}{
    \draw (network-3-2) -- (network-2-\a);
    \draw (network-3-3) -- (network-2-\a);
    \draw [-stealth] ([yshift=5mm]network-1-\a.north) -- (network-1-\a);
    \foreach \b in {1,...,4}
      \draw (network-1-\a) -- (network-2-\b);
  }
  \draw [stealth-] ([yshift=-5mm]network-3-2.south) -- (network-3-2);
  \draw [stealth-] ([yshift=-5mm]network-3-3.south) -- (network-3-3);
\end{tikzpicture}

```

The following example is adapted from code written by Kjell Magne Fauske, which is based on the following paper: K. Bossley, M. Brown, and C. Harris, Neurofuzzy identification of an autonomous underwater vehicle, *International Journal of Systems Science*, 1999, 30, 901–913.

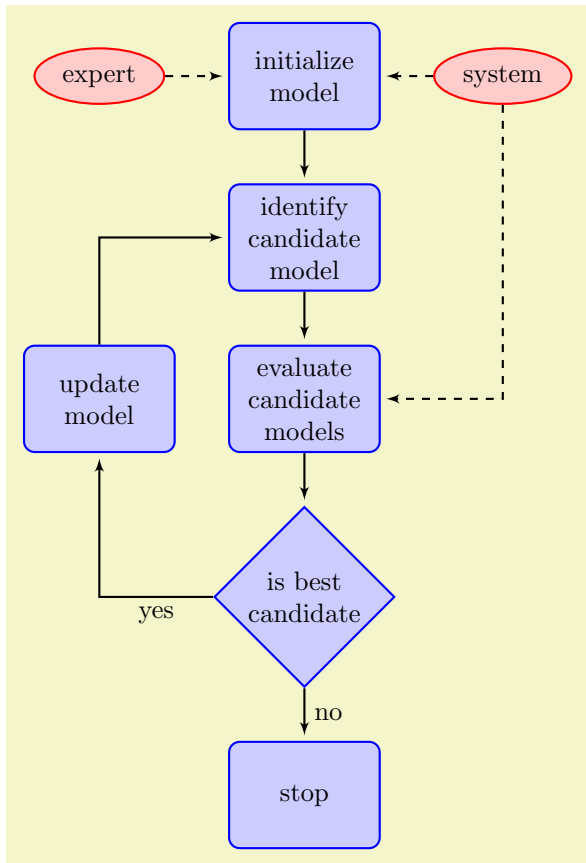



```

\begin{tikzpicture}
  [auto,
  decision/.style={diamond, draw=blue, thick, fill=blue!20,
    text width=4.5em,align=flush center,
    inner sep=1pt},
  block/.style   ={{rectangle, draw=blue, thick, fill=blue!20,
    text width=5em,align=center, rounded corners,
    minimum height=4em}},
  line/.style    ={{draw, thick, -latex',shorten >=2pt}},
  cloud/.style   ={{draw=red, thick, ellipse,fill=red!20,
    minimum height=2em}}]

\matrix [column sep=5mm,row sep=7mm]
{
  % row 1
  \node [cloud] (expert)  {expert}; &
  \node [block] (init)    {initialize model}; &
  \node [cloud] (system)  {system}; \\
  % row 2
  & \node [block] (identify) {identify candidate model}; & \\
  % row 3
  \node [block] (update)  {update model}; &
  \node [block] (evaluate) {evaluate candidate models}; & \\
  % row 4
  & \node [decision] (decide) {is best candidate}; & \\
  % row 5
  & \node [block] (stop)     {stop}; & \\
};
\begin{scope}[every path/.style=line]
  \path (init) -- (identify);
  \path (identify) -- (evaluate);
  \path (evaluate) -- (decide);
  \path (update) |- (identify);
  \path (decide) -| node [near start] {yes} (update);
  \path (decide) -- node [midway] {no} (stop);
  \path [dashed] (expert) -- (init);
  \path [dashed] (system) -- (init);
  \path [dashed] (system) |- (evaluate);
\end{scope}
\end{tikzpicture}

```

## 18 Making Trees Grow

### 18.1 Introduction to the Child Operation

Trees are a common way of visualizing hierarchical structures. A simple tree looks like this:

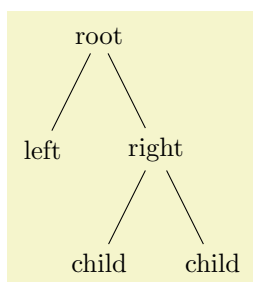

```
\begin{tikzpicture}
  \node {root}
    child {node {left}}
    child {node {right}}
      child {node {child}}
      child {node {child}}
  };
\end{tikzpicture}
```

Admittedly, in reality trees are more likely to grow *upward* and not downward as above. You can tell whether the author of a paper is a mathematician or a computer scientist by looking at the direction their trees grow. A computer scientist's trees will grow downward while a mathematician's tree will grow upward. Naturally, the *correct* way is the mathematician's way, which can be specify as follows:

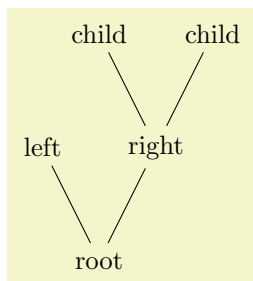

```
\begin{tikzpicture}
  \node {root} [grow'=up]
    child {node {left}}
    child {node {right}}
      child {node {child}}
      child {node {child}}
  };
\end{tikzpicture}
```

In TikZ, trees are specified by adding *children* to a node on a path using the `child` operation:

```
\path ... child[options]foreach<variables>in{<values>}{<child path>} ... ;
```

This operation should directly follow a completed `node` operation or another `child` operation, although it is permissible that the first `child` operation is preceded by options (we will come to that).

When a `node` operation like `node {X}` is followed by `child`, TikZ starts counting the number of child nodes that follow the original `node {X}`. For this, it scans the input and stores away each `child` and its arguments until it reaches a path operation that is not a `child`. Note that this will fix the character codes of all text inside the child arguments, which means, in essence, that you cannot use verbatim text inside the nodes inside a `child`. Sorry.

Once the children have been collected and counted, TikZ starts generating the child nodes. For each child of a parent node TikZ computes an appropriate position where the child is placed. For each child, the coordinate system is transformed so that the origin is at this position. Then the *child path* is drawn. Typically, the child path just consists of a `node` specification, which results in a node being drawn at the child's position. Finally, an edge is drawn from the first node in the *child path* to the parent node.

The optional `foreach` part (note that there is no backslash before `foreach`) allows you to specify multiple children in a single `child` command. The idea is the following: A `\foreach` statement is (internally) used to iterate over the list of *values*. For each value in this list, a new `child` is added to the node. The syntax for *variables* and for *values* is the same as for the `\foreach` statement, see Section 56. For example, when you say

```
node {root} child [red] foreach \name in {1,2} {node {\name}}
```

the effect will be the same as if you had said

```
node {root} child[red] {node {1}} child[red] {node {2}}
```

When you write

```
node {root} child[\pos] foreach \name/\pos in {1/left,2/right} {node[\pos] {\name}}
```

the effect will be the same as for

```
node {root} child[left] {node[left] {1}} child[right] {node[right] {2}}
```

You can nest things as in the following example:



```
\begin{tikzpicture}
[level distance=4mm,level/.style={sibling distance=8mm/#1}]
\coordinate
child foreach \x in {0,1}
{child foreach \y in {0,1}
{child foreach \z in {0,1}}};
\end{tikzpicture}
```

The details and options for this operation are described in the rest of this present section.

## 18.2 Child Paths and the Child Nodes

For each `child` of a root node, its *child path* is inserted at a specific location in the picture (the placement rules are discussed in Section 18.5). The first node in the *child path*, if it exists, is special and called the *child node*. If there is no first node in the *child path*, that is, if the *child path* is missing (including the curly braces) or if it does not start with `node` or with `coordinate`, then an empty child node of shape `coordinate` is automatically added.

Consider the example `\node {x} child {node {y}} child;`. For the first child, the *child path* has the child node `node {y}`. For the second child, no child node is specified and, thus, it is just `coordinate`.

As for any normal node, you can give the child node a name, shift it around, or use options to influence how it is rendered.

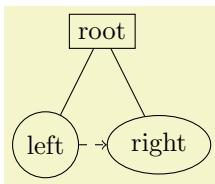

```
\begin{tikzpicture}
\node[rectangle,draw] {root}
child {node[circle,draw] (left node) {left}}
child {node[ellipse,draw] (right node) {right}};
\draw[dashed,->] (left node) -- (right node);
\end{tikzpicture}
```

In many cases, the *child path* will just consist of a specification of a child node and, possibly, children of this child node. However, the node specification may be followed by arbitrary other material that will be added to the picture, transformed to the child's coordinate system. For your convenience, a move-to (0,0) operation is inserted automatically at the beginning of the path. Here is an example:

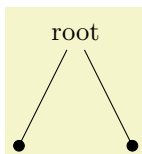

```
\begin{tikzpicture}
\node {root}
child {[fill] circle (2pt)}
child {[fill] circle (2pt)};
\end{tikzpicture}
```

At the end of the *child path* you may add a special path operation called `edge from parent`. If this operation is not given by yourself somewhere on the path, it will be automatically added at the end. This option causes a connecting edge from the parent node to the child node to be added to the path. By giving options to this operation you can influence how the edge is rendered. Also, nodes following the `edge from parent` operation will be placed on this edge, see Section 18.6 for details.

To sum up:

1. The child path starts with a node specification. If it is not there, it is added automatically.
2. The child path ends with a `edge from parent` operation, possibly followed by nodes to be put on this edge. If the operation is not given at the end, it is added automatically.

## 18.3 Naming Child Nodes

Child nodes can be named like any other node using either the `name` option or the special syntax in which the name of the node is placed in round parentheses between the `node` operation and the node's text.

If you do not assign a name to a child node, TikZ will automatically assign a name as follows: Assume that the name of the parent node is, say, `parent`. (If you did not assign a name to the parent, TikZ will do

so itself, but that name will not be user-accessible.) The first child of `parent` will be named `parent-1`, the second child is named `parent-2`, and so on.

This naming convention works recursively. If the second child `parent-2` has children, then the first of these children will be called `parent-2-1` and the second `parent-2-2` and so on.

If you assign a name to a child node yourself, no name is generated automatically (the node does not have two names). However, “counting continues,” which means that the third child of `parent` is called `parent-3` independently of whether you have assigned names to the first and/or second child of `parent`.

Here is an example:

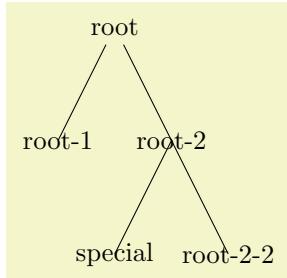

```
\begin{tikzpicture}
\node (root) {root}
  child
  child {
    child {coordinate (special)}
    child
  };
\node at (root-1) {root-1};
\node at (root-2) {root-2};
\node at (special) {special};
\node at (root-2-2) {root-2-2};
\end{tikzpicture}
```

## 18.4 Specifying Options for Trees and Children

Each `child` may have its own *options*, which apply to “the whole child,” including all of its grandchildren. Here is an example:

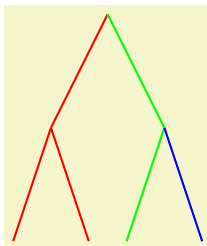

```
\begin{tikzpicture}
[thick,level 2/.style={sibling distance=10mm}]
\coordinate
  child[red] {child child}
  child[green] {child child[blue]};
\end{tikzpicture}
```

The options of the root node have no effect on the children since the options of a node are always “local” to that node. Because of this, the edges in the following tree are black, not red.

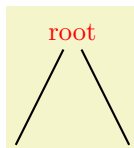

```
\begin{tikzpicture}[thick]
\node [red] {root}
  child
  child;
\end{tikzpicture}
```

This raises the problem of how to set options for *all* children. Naturally, you could always set options for the whole path as in `\path [red] node {root} child child;` but this is bothersome in some situations. Instead, it is easier to give the options *before the first child* as follows:

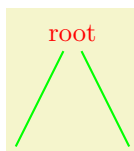

```
\begin{tikzpicture}[thick]
\node [red] {root}
  [green] % option applies to all children
  child
  child;
\end{tikzpicture}
```

Here is the set of rules:

- Options for the whole tree are given before the root node.
- Options for the root node are given directly to the `node` operation of the root.
- Options for all children can be given between the root node and the first child.
- Options applying to a specific child path are given as options to the `child` operation.
- Options applying to the node of a child, but not to the whole child path, are given as options to the `node` command inside the *child path*.

```

\begin{tikzpicture}
  \path
  [...] % Options apply to the whole tree
  node[...] {root} % Options apply to the root node only
  [...] % Options apply to all children
  child[...] % Options apply to this child and all its children
  {
    node[...] {} % Options apply to the child node only
    ...
  }
  child[...] % Options apply to this child and all its children
;
\end{tikzpicture}

```

There are additional styles that influence how children are rendered:

`/tikz/every child` (style, initially empty)

This style is used at the beginning of each child, as if you had given the style's contents as options to the `child` operation.

`/tikz/every child node` (style, initially empty)

This style is used at the beginning of each child node in addition to the `every node` style.

`/tikz/level=number` (style, no default, initially empty)

This style is executed at the beginning of each set of children, where *number* is the current level in the current tree. For example, when you say `\node {x} child child;`, then `level=1` is used before the first `child`. The style or code of this key will be passed *number* as its first parameter. If this first `child` has children itself, then `level=2` would be used for them.

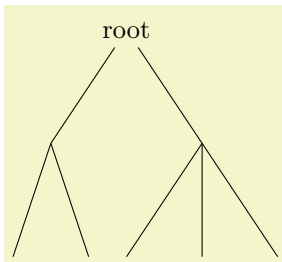

```

\begin{tikzpicture}[level/.style={sibling distance=20mm/#1}]
  \node {root}
  child { child child }
  child { child child child };
\end{tikzpicture}

```

`/tikz/level number` (style, initially empty)

This style is used in addition to the `level` style. So, when you say `\node {x} child child;`, then the following key list is executed: `level=1,level 1`.

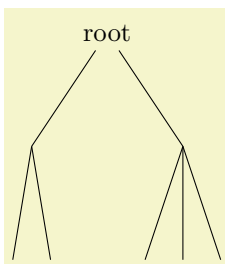

```

\begin{tikzpicture}
  [level 1/.style={sibling distance=20mm},
  level 2/.style={sibling distance=5mm}]
  \node {root}
  child { child child }
  child { child child child };
\end{tikzpicture}

```

## 18.5 Placing Child Nodes

### 18.5.1 Basic Idea

Perhaps the most difficult part in drawing a tree is the correct layout of the children. Typically, the children have different sizes and it is not easy to arrange them in such a manner that not too much space is wasted, the children do not overlap, and they are either evenly spaced or their centers are evenly distributed. Calculating good positions is especially difficult since a good position for the first child may depend on the size of the last child.

In TikZ, a comparatively simple approach is taken to placing the children. In order to compute a child's position, all that is taken into account is the number of the current child in the list of children and the number of children in this list. Thus, if a node has five children, then there is a fixed position for the first child, a position for the second child, and so on. These positions *do not depend on the size of the children* and, hence, children can easily overlap. However, since you can use options to shift individual children a bit, this is not as great a problem as it may seem.

Although the placement of the children only depends on their number in the list of children and the total number of children, everything else about the placement is highly configurable. You can change the distance between children (appropriately called the `sibling distance`) and the distance between levels of the tree. These distances may change from level to level. The direction in which the tree grows can be changed globally and for parts of the tree. You can even specify your own “growth function” to arrange children on a circle or along special lines or curves.

### 18.5.2 Default Growth Function

The default growth function works as follows: Assume that we are given a node and five children. These children will be placed on a line with their centers (or, more generally, with their anchors) spaced apart by the current `sibling distance`. The line is orthogonal to the current *direction of growth*, which is set with the `grow` and `grow'` option (the latter option reverses the ordering of the children). The distance from the line to the parent node is given by the `level distance`.

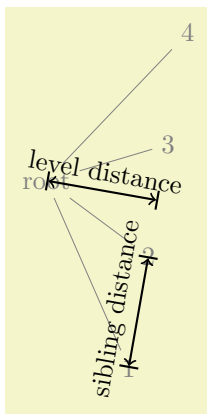

```
\begin{tikzpicture}
  \path [help lines]
    node (root) {root}
    [grow=-10]
    child {node {1}}
    child {node {2}}
    child {node {3}}
    child {node {4}};

  \draw[|<->,thick] (root-1.center)
    -- node[above,sloped] {sibling distance} (root-2.center);

  \draw[|<->,thick] (root.center)
    -- node[above,sloped] {level distance} +(-10:\tikzleveldistance);
\end{tikzpicture}
```

`/tikz/level distance=<distance>` (no default, initially 15mm)

This key determines the distance between different levels of the tree, more precisely, between the parent and the line on which its children are arranged. When given to a single child, this will set the distance for this child only.

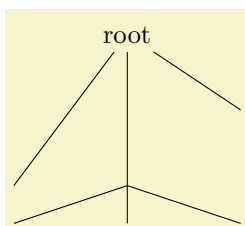

```
\begin{tikzpicture}
  \node {root}
    [level distance=20mm]
    child
    child {
      [level distance=5mm]
      child
      child
      child
    }
    child[level distance=10mm];
\end{tikzpicture}
```

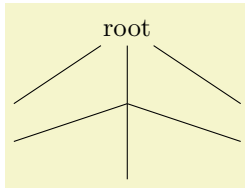

```
\begin{tikzpicture}
[level 1/.style={level distance=10mm},
level 2/.style={level distance=5mm}]
\node {root}
child
child {
child
child[level distance=10mm]
child
}
child;
\end{tikzpicture}
```

`/tikz/sibling distance=<distance>`

(no default, initially 15mm)

This key specifies the distance between the anchors of the children of a parent node.



```
\begin{tikzpicture}
[level distance=4mm,
level 1/.style={sibling distance=8mm},
level 2/.style={sibling distance=4mm},
level 3/.style={sibling distance=2mm}]
\coordinate
child {
child {child child}
child {child child}
}
child {
child {child child}
child {child child}
};
\end{tikzpicture}
```

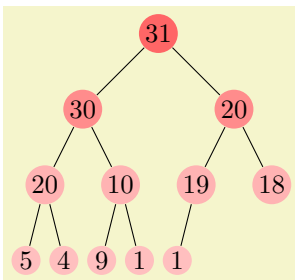

```
\begin{tikzpicture}
[level distance=10mm,
every node/.style={fill=red!60,circle,inner sep=1pt},
level 1/.style={sibling distance=20mm,nodes={fill=red!45}},
level 2/.style={sibling distance=10mm,nodes={fill=red!30}},
level 3/.style={sibling distance=5mm,nodes={fill=red!25}}]
\node {31}
child {node {30}
child {node {20}
child {node {5}}
child {node {4}}
}
child {node {10}
child {node {9}}
child {node {1}}
}
}
child {node {20}
child {node {19}
child {node {1}}
child[missing]
}
child {node {18}}
};
\end{tikzpicture}
```

`/tikz/grow=<direction>`

(no default)

This key is used to define the *<direction>* in which the tree will grow. The *<direction>* can either be an angle in degrees or one of the following special text strings: **down**, **up**, **left**, **right**, **north**, **south**, **east**, **west**, **north east**, **north west**, **south east**, and **south west**. All of these have “their obvious meaning,” so, say, **south west** is the same as the angle  $-135^\circ$ .

As a side effect, this option installs the default growth function.

In addition to setting the direction, this option also has a seemingly strange effect: It sets the sibling distance for the current level to `0pt`, but leaves the sibling distance for later levels unchanged.

This somewhat strange behaviour has a highly desirable effect: If you give this option before the list of children of a node starts, the “current level” is still the parent level. Each child will be on a later level and, hence, the sibling distance will be as specified originally. This will cause the children to be neatly aligned in a line orthogonal to the given  $\langle direction \rangle$ . However, if you give this option locally to a single child, then “current level” will be the same as the child’s level. The zero sibling distance will then cause the child to be placed exactly at a point at distance `level distance` in the direction  $\langle direction \rangle$ . However, the children of the child will be placed “normally” on a line orthogonal to the  $\langle direction \rangle$ .

These placement effects are best demonstrated by some examples:

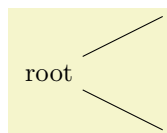

```
\tikz \node {root} [grow=right] child child;
```

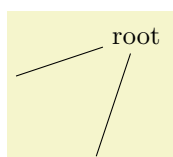

```
\tikz \node {root} [grow=south west] child child;
```

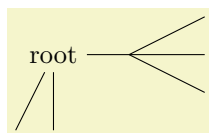

```
\begin{tikzpicture}[level distance=10mm,sibling distance=5mm]
\node {root}
  [grow=down]
  child
  child
  child[grow=right] {
    child child child
  };
\end{tikzpicture}
```

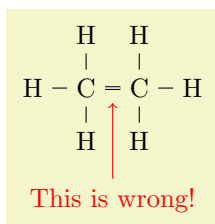

```
\begin{tikzpicture}[level distance=2em]
\node {C}
  child[grow=up] {node {H}}
  child[grow=left] {node {H}}
  child[grow=down] {node {H}}
  child[grow=right] {node {C}
    child[grow=up] {node {H}}
    child[grow=right] {node {H}}
    child[grow=down] {node {H}}
    edge from parent[double]
    coordinate (wrong)
  };
\draw[<-,red] ([yshift=-2mm]wrong) -- +(0,-1)
  node[below]{This is wrong!};
\end{tikzpicture}
```

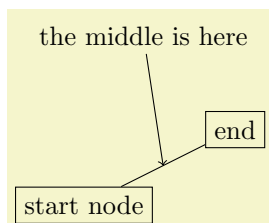

```
\begin{tikzpicture}
\node[rectangle,draw] (a) at (0,0) {start node};
\node[rectangle,draw] (b) at (2,1) {end};

\draw (a) -- (b)
  node[coordinate,midway] {}
  child[grow=100,<-] {node[above] {the middle is here}};
\end{tikzpicture}
```

`/tikz/grow'= $\langle direction \rangle$`  (no default)

This key has the same effect as `grow`, only the children are arranged in the opposite order.

### 18.5.3 Missing Children

Sometimes one or more of the children of a node are “missing.” Such a missing child will count as a child with respect to the total number of children and also with respect to the current child count, but it will not be rendered.



`/tikz/missing=<true or false>`

(default true)

If this option is given to a child, the current child counter is increased, but the child is otherwise ignored. In particular, the normal contents of the child is completely ignored.

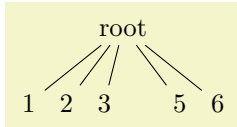

```
\begin{tikzpicture}[level distance=10mm,sibling distance=5mm]
  \node {root} [grow=down]
    child { node {1} }
    child { node {2} }
    child { node {3} }
    child[missing] { node {4} }
    child { node {5} }
    child { node {6} };
\end{tikzpicture}
```

#### 18.5.4 Custom Growth Functions

`/tikz/growth parent anchor=<anchor>`

(no default, initially center)

This key allows you to specify which anchor of the parent node is to be used for computing the children's position. For example, when there is only one child and the `level distance` is 2cm, then the child node will be placed two centimeters below the `<anchor>` of the parent node. "Being placed" means that the child node's anchor (which is the anchor specified using the `anchor=` option in the `node` command of the child) is two centimeters below the parent node's `<anchor>`.

In the following example, the two red lines both have length 1cm.

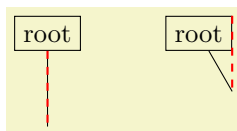

```
\begin{tikzpicture}[level distance=1cm]
  \node [rectangle,draw] (a) at (0,0) {root}
    [growth parent anchor=south] child;

  \node [rectangle,draw] (b) at (2,0) {root}
    [growth parent anchor=north east] child;

  \draw [red,thick,dashed] (a.south) -- (a-1);
  \draw [red,thick,dashed] (b.north east) -- (b-1);
\end{tikzpicture}
```

In the next example, the top and bottom nodes are aligned at the top and the bottom.

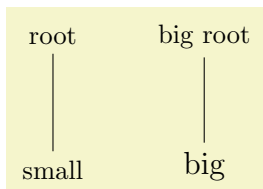

```
\begin{tikzpicture}
  [level distance=2cm,growth parent anchor=north,
  every node/.style={anchor=north,rectangle,draw}
  every child node/.style={anchor=south}]

  \node at (0,0) {root} child {node {small}};

  \node at (2,0) {big root} child {node {\large big}};
\end{tikzpicture}
```

`/tikz/growth function=<macro name>`

(no default, initially an internal function)

This rather low-level option allows you to set a new growth function. The `<macro name>` must be the name of a macro without parameters. This macro will be called for each child of a node. The initial function is an internal function that corresponds to downward growth.

The effect of executing the macro should be the following: It should transform the coordinate system in such a way that the origin becomes the place where the current child should be anchored. When the macro is called, the current coordinate system will be setup such that the anchor of the parent node is in the origin. Thus, in each call, the `<macro name>` must essentially do a shift to the child's origin. When the macro is called, the  $\text{\TeX}$  counter `\tikznumberofchildren` will be set to the total number of children of the parent node and the counter `\tikznumberofcurrentchild` will be set to the number of the current child.

The macro may, in addition to shifting the coordinate system, also transform the coordinate system further. For example, it could be rotated or scaled.

Additional growth functions are defined in the library, see Section 50.

## 18.6 Edges From the Parent Node

Every child node is connected to its parent node via a special kind of edge called the **edge from parent**. This edge is added to the *child path* when the following path operation is encountered:

```
\path ... edge from parent[options] ... ;
```

This path operation can only be used inside *child paths* and should be given at the end, possibly followed by node specifications (we will come to that). If a *child path* does not contain this operation, it will be added at the end of the *child path* automatically.

This operation has several effects. The most important is that it inserts the current “edge from parent path” into the child path. The edge from parent path can be set using the following key:

```
/tikz/edge from parent path=<path> (no default, initially code shown below)
```

This options allows you to set the edge from parent path to a new path. Initially, this path is the following:

```
(\tikzparentnode\tikzparentanchor) -- (\tikzchildnode\tikzchildanchor)
```

The `\tikzparentnode` is a macro that will expand to the name of the parent node. This works even when you have not assigned a name to the parent node, in this case an internal name is automatically generated. The `\tikzchildnode` is a macro that expands to the name of the child node. The two `...anchor` macros are empty by default. So, what is essentially inserted is just the path segment `(\tikzparentnode) -- (\tikzchildnode)`; which is exactly an edge from the parent to the child.

You can modify this edge from parent path to achieve all sorts of effects. For example, we could replace the straight line by a curve as follows:

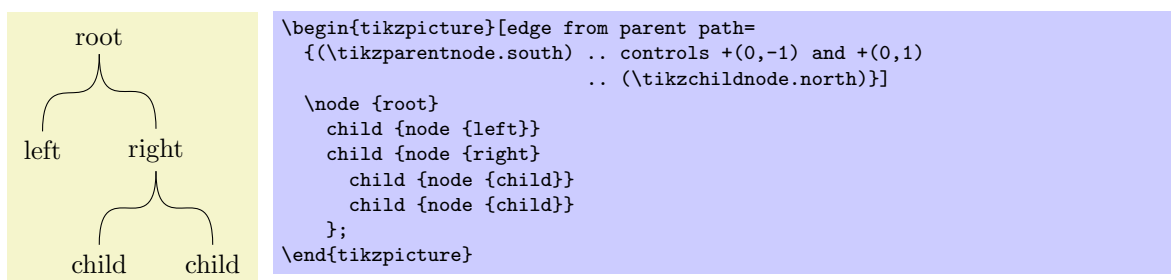

Further useful edge from parent paths are defined in the tree library, see Section 50.

As said before, the anchors in the default edge from parent path are empty. However, you can set them using the following keys:

```
/tikz/child anchor=<anchor> (no default, initially border)
```

Specifies the anchor where the edge from parent meets the child node by setting the macro `\tikzchildanchor` to `.<anchor>`.

If you specify `border` as the *anchor*, then the macro `\tikzchildanchor` is set to the empty string. The effect of this is that the edge from the parent will meet the child on the border at an automatically calculated position.

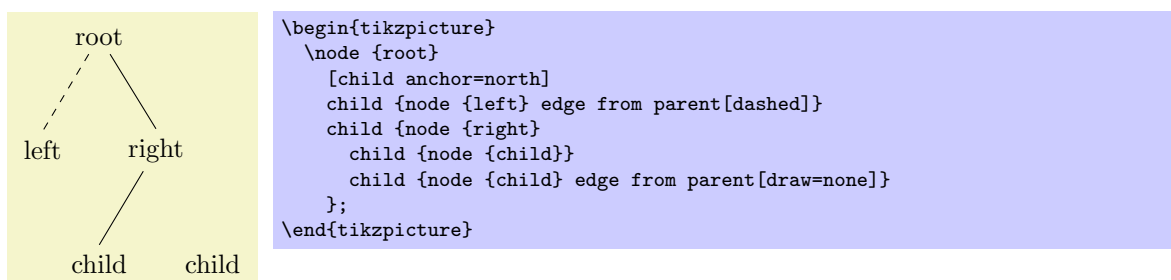

```
/tikz/parent anchor=<anchor> (no default, initially border)
```

This option works the same way as the `child anchor`, only for the parent.

Besides inserting the edge from parent path, the `edge from parent` operation has another effect: The  $\langle options \rangle$  are inserted directly before the edge from parent path and the following style is also installed prior to inserting the path:

`/tikz/edge from parent`

(style, initially draw)

This style is inserted right before the edge from parent path and before the  $\langle options \rangle$  are inserted.

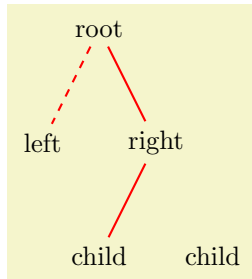

```
\begin{tikzpicture}
[edge from parent/.style={draw,red,thick}]
\node {root}
  child {node {left} edge from parent[dashed]}
  child {node {right}
    child {node {child}}
    child {node {child} edge from parent[draw=none]}
  };
\end{tikzpicture}
```

Note: The  $\langle options \rangle$  inserted before the edge from parent path is added *apply to the whole child path*. Thus, it is not possible to, say, draw a circle in red as part of the child path and then have an edge to parent in blue. However, as always, the child node is a node and can be drawn in a totally different way.

Finally, the `edge from parent` operation has one more effect: It causes all nodes *following* the operation to be placed on the edge. This is the same effect as if you had added the `pos` option to all these nodes, see also Section 16.8.

As an example, consider the following code:

```
\node (root) {} child {node (child) {} edge to parent node {label}};
```

The `edge to parent` operation and the following `node` operation will, together, have the same effect as if we had said:

```
(root) -- (child) node [pos=0.5] {label}
```

Here is a more complicated example:

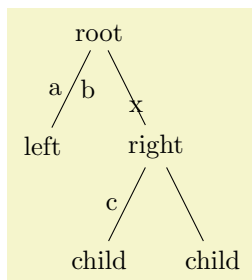

```
\begin{tikzpicture}
\node {root}
  child {
    node {left}
    edge from parent
    node[left] {a}
    node[right] {b}
  }
  child {
    node {right}
    child {
      node {child}
      edge from parent
      node[left] {c}
    }
    child {node {child}}
    edge from parent
    node[near end] {x}
  };
\end{tikzpicture}
```

## 19 Plots of Functions

### 19.1 When Should One Use TikZ for Generating Plots?

There exist many powerful programs that produce plots, examples are GNUPLOT or MATHEMATICA. These programs can produce two different kinds of output: First, they can output a complete plot picture in a certain format (like PDF) that includes all low-level commands necessary for drawing the complete plot (including axes and labels). Second, they can usually also produce “just plain data” in the form of a long list of coordinates. Most of the powerful programs consider it a to be “a bit boring” to just output tabled data and very much prefer to produce fancy pictures. Nevertheless, when coaxed, they can also provide the plain data.

*Note that is often not necessary to use TikZ for plots.* Programs like GNUPLOT can produce very sophisticated plots and it is usually much easier to simply include these plots as a finished PDF or PostScript graphics.

However, there are a number of reasons why you may wish to invest time and energy into mastering the PGF commands for creating plots:

- Virtually all plots produced by “external programs” use different fonts from the one used in your document.
- Even worse, formulas will look totally different, if they can be rendered at all.
- Line width will usually be too large or too small.
- Scaling effects upon inclusion can create a mismatch between sizes in the plot and sizes in the text.
- The automatic grid generated by most programs is mostly distracting.
- The automatic ticks generated by most programs are cryptic numerics. (Try adding a tick reading “ $\pi$ ” at the right point.)
- Most programs make it very easy to create “chart junk” in a most convenient fashion. All show, no content.
- Arrows and plot marks will almost never match the arrows used in the rest of the document.

The above list is not exhaustive, unfortunately.

### 19.2 The Plot Path Operation

The `plot` path operation can be used to append a line or curve to the path that goes through a large number of coordinates. These coordinates are either given in a simple list of coordinates, read from some file, or they are computed on the fly.

The syntax of the `plot` comes in different versions.

```
\path ... --plot<further arguments> ...;
```

This operation plots the curve through the coordinates specified in the  $\langle$ *further arguments* $\rangle$ . The current (sub)path is simply continued, that is, a line-to operation to the first point of the curve is implicitly added. The details of the  $\langle$ *further arguments* $\rangle$  will be explained in a moment.

```
\path ... plot<further arguments> ...;
```

This operation plots the curve through the coordinates specified in the  $\langle$ *further arguments* $\rangle$  by first “moving” to the first coordinate of the curve.

The  $\langle$ *further arguments* $\rangle$  are used in three different ways to specifying the coordinates of the points to be plotted:

1. `--plot` [ $\langle$ *local options* $\rangle$ ] `coordinates` { $\langle$ *coordinate 1* $\rangle$   $\langle$ *coordinate 2* $\rangle$  ...  $\langle$ *coordinate n* $\rangle$ }
2. `--plot` [ $\langle$ *local options* $\rangle$ ] `file` { $\langle$ *filename* $\rangle$ }
3. `--plot` [ $\langle$ *local options* $\rangle$ ]  $\langle$ *coordinate expression* $\rangle$
4. `--plot` [ $\langle$ *local options* $\rangle$ ] `function` { $\langle$ *gnuplot formula* $\rangle$ }

These different ways are explained in the following.

## 19.3 Plotting Points Given Inline

In the first two cases, the points are given directly in the  $\text{\TeX}$ -file as in the following example:



```
\tikz \draw plot coordinates {(0,0) (1,1) (2,0) (3,1) (2,1) (10:2cm)};
```

Here is an example showing the difference between `plot` and `--plot`:



```
\begin{tikzpicture}
\draw (0,0) -- (1,1) plot coordinates {(2,0) (4,0)};
\draw[color=red,xshift=5cm]
(0,0) -- (1,1) -- plot coordinates {(2,0) (4,0)};
\end{tikzpicture}
```

## 19.4 Plotting Points Read From an External File

The second way of specifying points is to put them in an external file named  $\langle filename \rangle$ . Currently, the only file format that  $\text{\TeX}$  allows is the following: Each line of the  $\langle filename \rangle$  should contain one line starting with two numbers, separated by a space. Anything following the two numbers on the line is ignored. Also, lines starting with a `%` or a `#` are ignored as well as empty lines. (This is exactly the format that `GNUPLOT` produces when you say `set terminal table`.) If necessary, more formats will be supported in the future, but it is usually easy to produce a file containing data in this form.

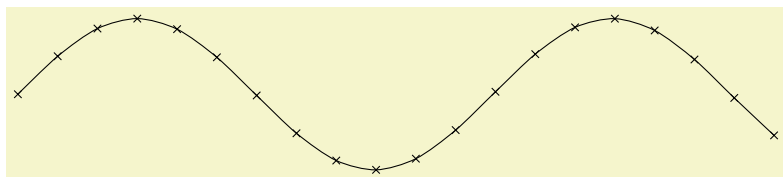

```
\tikz \draw plot[mark=x,smooth] file {plots/pgfmanual-sine.table};
```

The file `plots/pgfmanual-sine.table` reads:

```
#Curve 0, 20 points
#x y type
0.00000 0.00000 i
0.52632 0.50235 i
1.05263 0.86873 i
1.57895 0.99997 i
...
9.47368 -0.04889 i
10.00000 -0.54402 i
```

It was produced from the following source, using `gnuplot`:

```
set terminal table
set output "../plots/pgfmanual-sine.table"
set format "%.5f"
set samples 20
plot [x=0:10] sin(x)
```

The  $\langle local\ options \rangle$  of the `plot` operation are local to each plot and do not affect other plots “on the same path.” For example, `plot[yshift=1cm]` will locally shift the plot 1cm upward. Remember, however, that most options can only be applied to paths as a whole. For example, `plot[red]` does not have the effect of making the plot red. After all, you are trying to “locally” make part of the path red, which is not possible.

## 19.5 Plotting a Function

When you plot a function, the coordinates of the plot data can be computed by evaluating a mathematical expression. Since  $\text{\TeX}$  comes with a mathematical engine, you can specify this expression and then have  $\text{\TeX}$  produce the desired coordinates for you, automatically.

Since this case is quite common when plotting a function, the syntax is easy: Following the `plot` command and its local options, you directly provide a *coordinate expression*. It looks like a normal coordinate, but inside you may use a special macro, which is `\x` by default, but this can be changed using the `variable` option. The *coordinate expression* is then evaluated for different values for `\x` and the resulting coordinates are plotted.

Note that you will often have to put the  $x$ - or  $y$ -coordinate inside braces, namely whenever you use an expression involving a parenthesis.

The following options influence how the *coordinate expression* is evaluated:

`/tikz/variable=<macro>` (no default, initially `x`)

Sets the macro whose value is set to the different values when *coordinate expression* is evaluated.

`/tikz/samples=<number>` (no default, initially 25)

Sets the number of samples used in the plot.

`/tikz/domain=<start>:<end>` (no default, initially `-5:5`)

Sets the domain between which the samples are taken.

`/tikz/samples at=<sample list>` (no default)

This option specifies a list of positions for which the variable should be evaluated. For instance, you can say `samples at={1,2,8,9,10}` to have the variable evaluated exactly for values 1, 2, 8, 9, and 10. You can use the `\foreach` syntax, so you can use `...` inside the *sample list*.

When this option is used, the `samples` and `domain` option are overruled. The other ways round, setting either `samples` or `domain` will overrule this option.

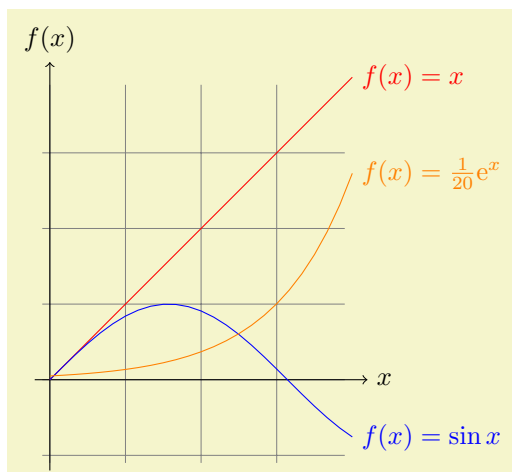

```
\begin{tikzpicture}[domain=0:4]
  \draw[very thin,color=gray] (-0.1,-1.1) grid (3.9,3.9);

  \draw[->] (-0.2,0) -- (4.2,0) node[right] {$x$};
  \draw[->] (0,-1.2) -- (0,4.2) node[above] {$f(x)$};

  \draw[color=red] plot (\x,\x) node[right] {$f(x) = x$};
  \draw[color=blue] plot (\x,{sin(\x r)}) node[right] {$f(x) = \sin x$};
  \draw[color=orange] plot (\x,{0.05*exp(\x)}) node[right] {$f(x) = \frac{1}{20} \mathrm{e}^x$};
\end{tikzpicture}
```

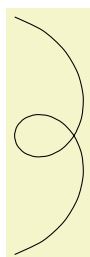

```
\tikz \draw[scale=0.5,domain=-3.141:3.141,smooth,variable=\t]
  plot ({\t*sin(\t r)},{\t*cos(\t r)});
```

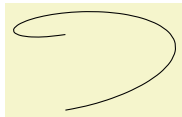

```
\tikz \draw[domain=0:360,smooth,variable=\t]
plot ({sin(\t)},\t/360,{cos(\t)});
```

## 19.6 Plotting a Function Using Gnuplot

Often, you will want to plot points that are given via a function like  $f(x) = x \sin x$ . Unfortunately,  $\text{\TeX}$  does not really have enough computational power to generate the points on such a function efficiently (it is a text processing program, after all). However, if you allow it,  $\text{\TeX}$  can try to call external programs that can easily produce the necessary points. Currently,  $\text{\TikZ}$  knows how to call `GNUPLLOT`.

When  $\text{\TikZ}$  encounters your operation `plot[id=<id>] function{x*sin(x)}` for the first time, it will create a file called `<prefix><id>.gnuplot`, where `<prefix>` is `\jobname`. by default, that is, the name of your main `.tex` file. If no `<id>` is given, it will be empty, which is alright, but it is better when each plot has a unique `<id>` for reasons explained in a moment. Next,  $\text{\TikZ}$  writes some initialization code into this file followed by `plot x*sin(x)`. The initialization code sets up things such that the `plot` operation will write the coordinates into another file called `<prefix><id>.table`. Finally, this table file is read as if you had said `plot file{<prefix><id>.table}`.

For the plotting mechanism to work, two conditions must be met:

1. You must have allowed  $\text{\TeX}$  to call external programs. This is often switched off by default since this is a security risk (you might, without knowing, run a  $\text{\TeX}$  file that calls all sorts of “bad” commands). To enable this “calling external programs” a command line option must be given to the  $\text{\TeX}$  program. Usually, it is called something like `shell-escape` or `enable-write18`. For example, for my `pdflatex` the option `--shell-escape` can be given.
2. You must have installed the `gnuplot` program and  $\text{\TeX}$  must find it when compiling your file.

Unfortunately, these conditions will not always be met. Especially if you pass some source to a coauthor and the coauthor does not have `GNUPLLOT` installed, he or she will have trouble compiling your files.

For this reason,  $\text{\TikZ}$  behaves differently when you compile your graphic for the second time: If upon reaching `plot[id=<id>] function{...}` the file `<prefix><id>.table` already exists *and* if the `<prefix><id>.gnuplot` file contains what  $\text{\TikZ}$  thinks that it “should” contain, the `.table` file is immediately read without trying to call a `gnuplot` program. This approach has the following advantages:

1. If you pass a bundle of your `.tex` file and all `.gnuplot` and `.table` files to someone else, that person can  $\text{\TeX}$  the `.tex` file without having to have `gnuplot` installed.
2. If the `\write18` feature is switched off for security reasons (a good idea), then, upon the first compilation of the `.tex` file, the `.gnuplot` will still be generated, but not the `.table` file. You can then simply call `gnuplot` “by hand” for each `.gnuplot` file, which will produce all necessary `.table` files.
3. If you change the function that you wish to plot or its domain,  $\text{\TikZ}$  will automatically try to regenerate the `.table` file.
4. If, out of laziness, you do not provide an `id`, the same `.gnuplot` will be used for different plots, but this is not a problem since the `.table` will automatically be regenerated for each plot on-the-fly. *Note: If you intend to share your files with someone else, always use an `id`, so that the file can be typeset without having `GNUPLLOT` installed.* Also, having unique `ids` for each plot will improve compilation speed since no external programs need to be called, unless it is really necessary.

When you use `plot function{<gnuplot formula>}`, the `<gnuplot formula>` must be given in the `gnuplot` syntax, whose details are beyond the scope of this manual. Here is the ultra-condensed essence: Use `x` as the variable and use the C-syntax for normal plots, use `t` as the variable for parametric plots. Here are some examples:

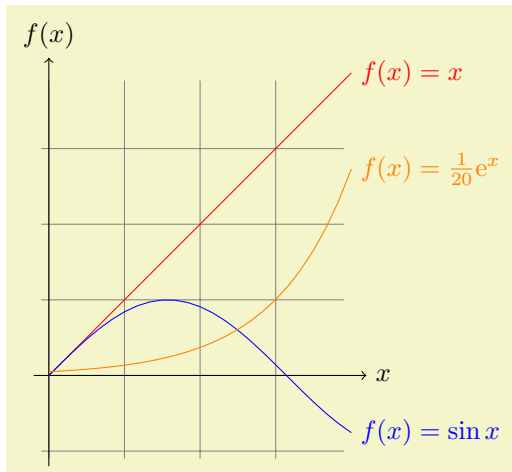

```

\begin{tikzpicture}[domain=0:4]
  \draw[very thin,color=gray] (-0.1,-1.1) grid (3.9,3.9);

  \draw[->] (-0.2,0) -- (4.2,0) node[right] {$x$};
  \draw[->] (0,-1.2) -- (0,4.2) node[above] {$f(x)$};

  \draw[color=red] plot[id=x] function{x} node[right] {$f(x) = x$};
  \draw[color=blue] plot[id=sin] function{sin(x)} node[right] {$f(x) = \sin x$};
  \draw[color=orange] plot[id=exp] function{0.05*exp(x)} node[right] {$f(x) = \frac{1}{20} \mathrm{e}^x$};
\end{tikzpicture}

```

The plot is influenced by the following options: First, the options `samples` and `domain` explained earlier. Second, there are some more specialized options.

`/tikz/parametric=(boolean)` (default `true`)

Sets whether the plot is a parametric plot. If true, then `t` must be used instead of `x` as the parameter and two comma-separated functions must be given in the *(gnuplot formula)*. An example is the following:

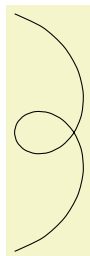

```

\tikz \draw[scale=0.5,domain=-3.141:3.141,smooth]
  plot[parametric,id=parametric-example] function{t*sin(t),t*cos(t)};

```

`/tikz/id=(id)` (no default)

Sets the identifier of the current plot. This should be a unique identifier for each plot (though things will also work if it is not, but not as well, see the explanations above). The *(id)* will be part of a filename, so it should not contain anything fancy like `*` or `$`.

`/tikz/prefix=(prefix)` (no default)

The *(prefix)* is put before each plot file name. The default is `\jobname.`, but if you have many plots, it might be better to use, say `plots/` and have all plots placed in a directory. You have to create the directory yourself.

`/tikz/raw gnuplot` (no value)

This key causes the *(gnuplot formula)* to be passed on to GNUPLOT without setting up the samples or the plot operation. Thus, you could write

```

plot[raw gnuplot,id=raw-example] function{set samples 25; plot sin(x)}

```

This can be useful for complicated things that need to be passed to GNUPLOT. However, for really complicated situations you should create a special external generating GNUPLOT file and use the `file-syntax` to include the table “by hand.”



The following styles influence the plot:

`/tikz/every plot` (style, initially empty)

This style is installed in each plot, that is, as if you always said

```
plot[every plot,...]
```

This is most useful for globally setting a prefix for all plots by saying:

```
\tikzset{every plot/.style={prefix=plots/}}
```

## 19.7 Placing Marks on the Plot

As we saw already, it is possible to add *marks* to a plot using the `mark` option. When this option is used, a copy of the plot mark is placed on each point of the plot. Note that the marks are placed *after* the whole path has been drawn/filled/shaded. In this respect, they are handled like text nodes.

In detail, the following options govern how marks are drawn:

`/tikz/mark=<mark mnemonic>` (no default)

Sets the mark to a mnemonic that has previously been defined using the `\pgfdeclareplotmark`. By default, `*`, `+`, and `x` are available, which draw a filled circle, a plus, and a cross as marks. Many more marks become available when the library `pgflibraryplotmarks` is loaded. Section 42.5 lists the available plot marks.

One plot mark is special: the `ball` plot mark is available only in TikZ. The `ball color` determines the balls's color. Do not use this option with a large number of marks since it will take very long to render in PostScript.

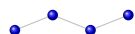
| Option                 | Effect                                                                              |
|------------------------|-------------------------------------------------------------------------------------|
| <code>mark=ball</code> |  |

`/tikz/mark repeat=<r>` (no default)

This option tells TikZ that only every  $r$ th mark should be drawn.

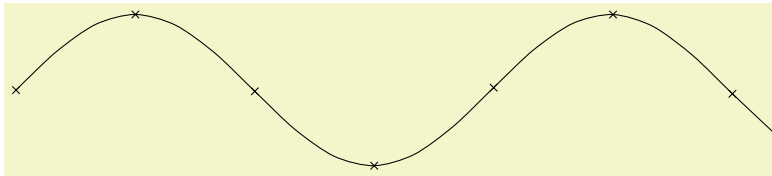

```
\tikz \draw plot[mark=x,mark repeat=3,smooth] file {plots/pgfmanual-sine.table};
```

`/tikz/mark phase=<p>` (no default)

This option tells TikZ that the first mark to be draw should be the  $p$ th, followed by the  $(p + r)$ th, then the  $(p + 2r)$ th, and so on.

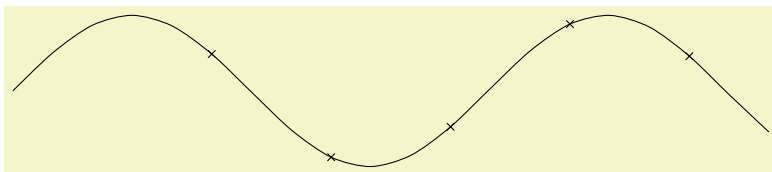

```
\tikz \draw plot[mark=x,mark repeat=3,mark phase=6,smooth] file {plots/pgfmanual-sine.table};
```

`/tikz/mark indices=<list>` (no default)

This option allows you to specify explicitly the indices at which a mark should be placed. Counting starts with 1. You can use the `\foreach` syntax, that is, `...` can be used.

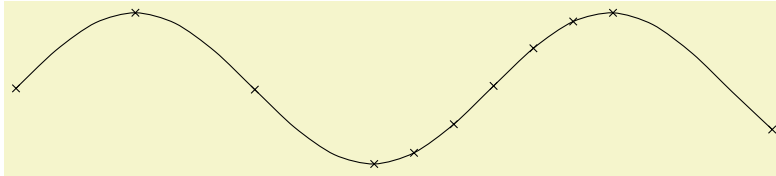

```
\tikz \draw plot[mark=x,mark indices={1,4,...,10,11,12,...,16,20},smooth]
file {plots/pgfmanual-sine.table};
```

`/tikz/mark size=<dimension>` (no default)

Sets the size of the plot marks. For circular plot marks,  $\langle dimension \rangle$  is the radius, for other plot marks  $\langle dimension \rangle$  should be about half the width and height.

This option is not really necessary, since you achieve the same effect by specifying `scale=<factor>` as a local option, where  $\langle factor \rangle$  is the quotient of the desired size and the default size. However, using `mark size` is a bit faster and more natural.

`/tikz/every mark` (style, no value)

This style is installed before drawing plot marks. For example, you can scale (or otherwise transform) the plot mark or set its color.

`/tikz/mark options=<options>` (no default)

Redefines every mark such that it sets  $\{ \langle options \rangle \}$ .

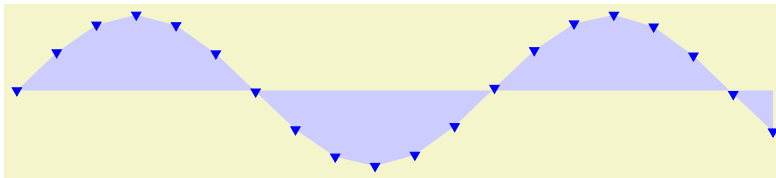

```
\tikz \fill[fill=blue!20]
plot[mark=triangle*,mark options={color=blue,rotate=180}]
file{plots/pgfmanual-sine.table} |- (0,0);
```

## 19.8 Smooth Plots, Sharp Plots, Jump Plots, Comb Plots and Bar Plots

There are different things the `plot` operation can do with the points it reads from a file or from the inlined list of points. By default, it will connect these points by straight lines. However, you can also use options to change the behavior of `plot`.

`/tikz/sharp plot` (no value)

This is the default and causes the points to be connected by straight lines. This option is included only so that you can “switch back” if you “globally” install, say, `smooth`.

`/tikz/smooth` (no value)

This option causes the points on the path to be connected using a smooth curve:

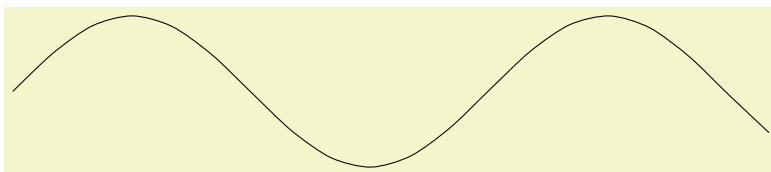

```
\tikz\draw plot[smooth] file{plots/pgfmanual-sine.table};
```

Note that the smoothing algorithm is not very intelligent. You will get the best results if the bending angles are small, that is, less than about  $30^\circ$  and, even more importantly, if the distances between points are about the same all over the plotting path.

`/tikz/tension=<value>` (no default)

This option influences how “tight” the smoothing is. A lower value will result in sharper corners, a higher value in more “round” curves. A value of 1 results in a circle if four points at quarter-positions on a circle are given. The default is 0.55. The “correct” value depends on the details of plot.

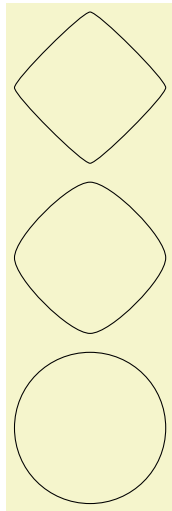

```
\begin{tikzpicture}[smooth cycle]
\draw plot[tension=0.2]
coordinates{(0,0) (1,1) (2,0) (1,-1)};
\draw[yshift=-2.25cm] plot[tension=0.5]
coordinates{(0,0) (1,1) (2,0) (1,-1)};
\draw[yshift=-4.5cm] plot[tension=1]
coordinates{(0,0) (1,1) (2,0) (1,-1)};
\end{tikzpicture}
```

`/tikz/smooth cycle` (no value)

This option causes the points on the path to be connected using a closed smooth curve.



```
\tikz[scale=0.5]
\draw plot[smooth cycle] coordinates{(0,0) (1,0) (2,1) (1,2)}
plot coordinates{(0,0) (1,0) (2,1) (1,2)} -- cycle;
```

`/tikz/const plot` (no value)

This option causes the points on the path to be connected using piecewise constant series of lines:

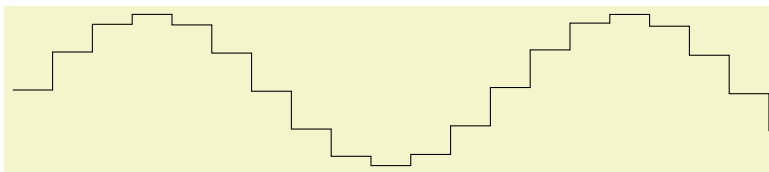

```
\tikz\draw plot[const plot] file{plots/pgfmanual-sine.table};
```

`/tikz/const plot mark left` (no value)

Just an alias for `/tikz/const plot`.

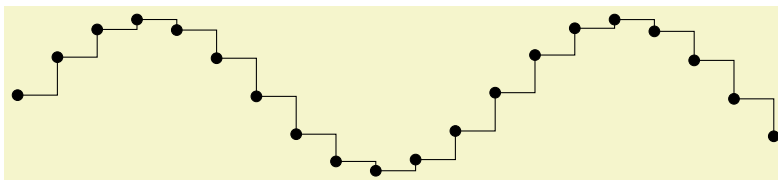

```
\tikz\draw plot[const plot mark left,mark=*] file{plots/pgfmanual-sine.table};
```

`/tikz/const plot mark right` (no value)

A variant of `/tikz/const plot` which places its mark on the right ends:

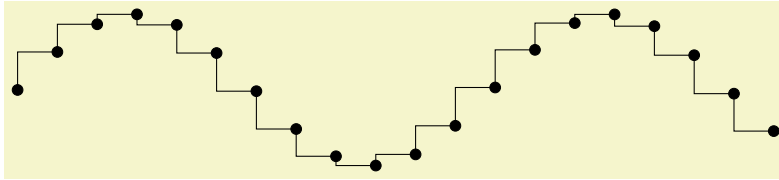

```
\tikz\draw plot[const plot mark right,mark=*] file{plots/pgfmanual-sine.table};
```

**/tikz/jump mark left**

(no value)

This option causes the points on the path to be drawn using piecewise constant, non-connected series of lines. If there are any marks, they will be placed on left open ends:

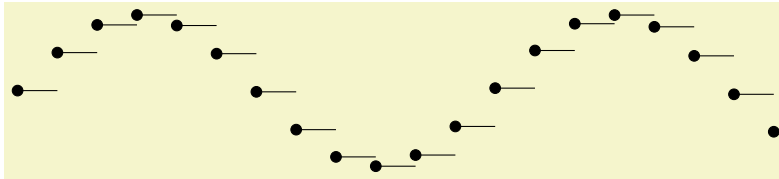

```
\tikz\draw plot[jump mark left, mark=*] file{plots/pgfmanual-sine.table};
```

**/tikz/jump mark right**

(no value)

This option causes the points on the path to be drawn using piecewise constant, non-connected series of lines. If there are any marks, they will be placed on right open ends:

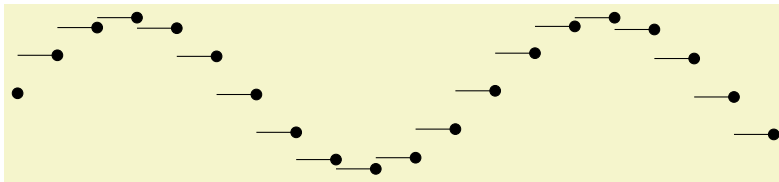

```
\tikz\draw plot[jump mark right, mark=*] file{plots/pgfmanual-sine.table};
```

**/tikz/ycomb**

(no value)

This option causes the plot operation to interpret the plotting points differently. Instead of connecting them, for each point of the plot a straight line is added to the path from the  $x$ -axis to the point, resulting in a sort of “comb” or “bar diagram.”

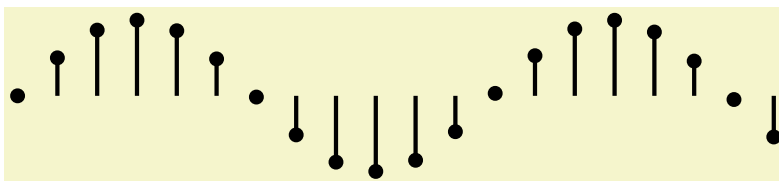

```
\tikz\draw[ultra thick] plot[ycomb,thin,mark=*] file{plots/pgfmanual-sine.table};
```



```
\begin{tikzpicture}[ycomb]
\draw[color=red,line width=6pt]
plot coordinates{(0,1) (.5,1.2) (1,.6) (1.5,.7) (2,.9)};
\draw[color=red!50,line width=4pt,xshift=3pt]
plot coordinates{(0,1.2) (.5,1.3) (1,.5) (1.5,.2) (2,.5)};
\end{tikzpicture}
```

**/tikz/xcomb**

(no value)

This option works like `ycomb` except that the bars are horizontal.



```
\tikz \draw plot[xcomb,mark=x] coordinates{(1,0) (0.8,0.2) (0.6,0.4) (0.2,1)};
```

### /tikz/polar comb

(no value)

This option causes a line from the origin to the point to be added to the path for each plot point.

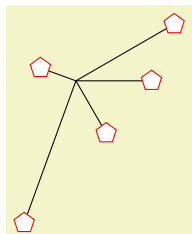

```
\tikz \draw plot[polar comb,
  mark=pentagon*,mark options={fill=white,draw=red},mark size=4pt]
  coordinates {(0:1cm) (30:1.5cm) (160:.5cm) (250:2cm) (-60:.8cm)};
```

### /tikz/ybar

(no value)

This option produces fillable bar plots. It is thus very similar to `ycomb`, but it employs rectangular shapes instead of line-to operations. It thus allows to use any fill- or pattern style.

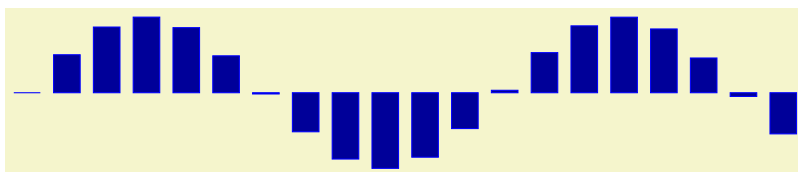

```
\tikz\draw[draw=blue,fill=blue!60!black] plot[ybar] file{plots/pgfmanual-sine.table};
```



```
\begin{tikzpicture}[ybar]
  \draw[color=red,fill=red!80,bar width=6pt]
    plot coordinates{(0,1) (.5,1.2) (1,.6) (1.5,.7) (2,.9)};
  \draw[color=red!50,fill=red!20,bar width=4pt,bar shift=3pt]
    plot coordinates{(0,1.2) (.5,1.3) (1,.5) (1.5,.2) (2,.5)};
\end{tikzpicture}
```

The use of `bar width` and `bar shift` is explained in the plot handler library documentation, section 42.4. Please refer to page 393.

### /tikz/xbar

(no value)

This option works like `ybar` except that the bars are horizontal.

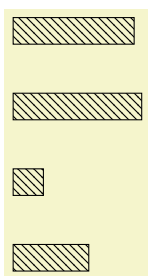

```
\tikz \draw[pattern=north west lines] plot[xbar]
  coordinates{(1,0) (0.4,1) (1.7,2) (1.6,3)};
```

### /tikz/ybar interval

(no value)

As `/tikz/ybar`, this options produces vertical bars. However, bars are centered at coordinate *intervals* instead of interval edges, and the bar's width is also determined relatively to the interval's length:



```
\begin{tikzpicture}[ybar interval,x=10pt]
  \draw[color=red,fill=red!80]
    plot coordinates{(0,2) (2,1.2) (3,.3) (5,1.7) (8,.9) (9,.9)};
\end{tikzpicture}
```

Since there are  $N$  intervals  $[x_i, x_{i+1}]$  for given  $N + 1$  coordinates, you will always have one coordinate more than bars. The last  $y$  value will be ignored.

You can configure relative shifts and relative bar width, which is explained in the plot handler library documentation, section 42.4. Please refer to page 394.

`/tikz/xbar interval`

(no value)

Works like `ybar interval`, but for horizontal bar plots.

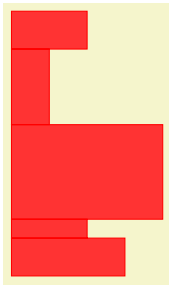

```
\begin{tikzpicture}[xbar interval,x=0.5cm,y=0.5cm]
\draw[color=red,fill=red!80]
plot coordinates {(3,0) (2,1) (4,1.5) (1,4) (2,6) (2,7)};
\end{tikzpicture}
```

`/tikz/only marks`

(no value)

This option causes only marks to be shown; no path segments are added to the actual path. This can be useful for quickly adding some marks to a path.

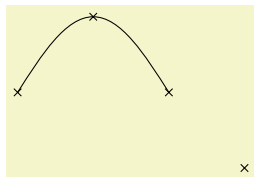

```
\tikz \draw (0,0) sin (1,1) cos (2,0)
plot[only marks,mark=x] coordinates{(0,0) (1,1) (2,0) (3,-1)};
```

## 20 Transparency

### 20.1 Overview

Normally, when you paint something using any of TikZ’s commands (this includes stroking, filling, shading, patterns, and images), the newly painted objects totally obscure whatever was painted earlier in the same area.

You can change this behaviour by using something that can be thought of as “(semi)transparent colors.” Such colors do not completely obscure the background, rather they blend the background with the new color. At first sight, using such semitransparent colors might seem quite straightforward, but the math going on in the background is quite involved and the correct handling of transparency fills some 64 pages in the PDF specification.

In the present section, we start with the different ways of specifying “how transparent” newly drawn objects should be. The simplest way is to just specify a percentage like “60% transparent.” A much more general way is to use something that I call a *fading*, also known as a soft mask or a mask.

At the end of the section we address the problem of creating so-called *transparency groups*. This problem arises when you paint over a position several times with a semitransparent color. Sometimes you want the effect to accumulate, sometimes you do not.

*Note:* Transparency is best supported by the pdfTeX driver. The SVG driver also has some support. For PostScript output, opacity is rendered correctly only with the most recent versions of GhostScript. Printers and other programs will typically ignore the opacity setting.

### 20.2 Specifying a Uniform Opacity

Specifying a stroke and/or fill opacity is quite easy using the following options.

`/tikz/draw opacity=<value>` (no default)

This option sets “how transparent” lines should be. A value of 1 means “fully opaque” or “not transparent at all,” a value of 0 means “fully transparent” or “invisible.” A value of 0.5 yields lines that are semitransparent.

Note that when you use PostScript as your output format, this option works only with recent versions of GhostScript.



```
\begin{tikzpicture}[line width=1ex]
  \draw (0,0) -- (3,1);
  \filldraw [fill=examplefill,draw opacity=0.5] (1,0) rectangle (2,1);
\end{tikzpicture}
```

Note that the `draw opacity` options only sets the opacity of drawn lines. The opacity of fillings is set using the option `fill opacity` (documented in Section 15.4.3. The option `opacity` sets both at the same time.

`/tikz/opacity=<value>` (no default)

Sets both the drawing and filling opacity to *<value>*.

The following predefined styles make it easier to use this option:

`/tikz/transparent` (style, no value)

Makes everything totally transparent and, hence, invisible.



```
\tikz{\fill[red] (0,0) rectangle (1,0.5);
       \fill[transparent,red] (0.5,0) rectangle (1.5,0.25); }
```

`/tikz/ultra nearly transparent` (style, no value)

Makes everything, well, ultra nearly transparent.



```
\tikz{\fill[red] (0,0) rectangle (1,0.5);
       \fill[ultra nearly transparent] (0.5,0) rectangle (1.5,0.25); }
```

`/tikz/very nearly transparent` (style, no value)



```
\tikz{\fill[red] (0,0) rectangle (1,0.5);
\fill[very nearly transparent] (0.5,0) rectangle (1.5,0.25); }
```

`/tikz/nearly transparent` (style, no value)



```
\tikz{\fill[red] (0,0) rectangle (1,0.5);
\fill[nearly transparent] (0.5,0) rectangle (1.5,0.25); }
```

`/tikz/semitransparent` (style, no value)



```
\tikz{\fill[red] (0,0) rectangle (1,0.5);
\fill[semitransparent] (0.5,0) rectangle (1.5,0.25); }
```

`/tikz/nearly opaque` (style, no value)



```
\tikz{\fill[red] (0,0) rectangle (1,0.5);
\fill[nearly opaque] (0.5,0) rectangle (1.5,0.25); }
```

`/tikz/very nearly opaque` (style, no value)



```
\tikz{\fill[red] (0,0) rectangle (1,0.5);
\fill[very nearly opaque] (0.5,0) rectangle (1.5,0.25); }
```

`/tikz/ultra nearly opaque` (style, no value)



```
\tikz{\fill[red] (0,0) rectangle (1,0.5);
\fill[ultra nearly opaque] (0.5,0) rectangle (1.5,0.25); }
```

`/tikz/opaque` (style, no value)

This yields completely opaque drawings, which is the default.



```
\tikz{\fill[red] (0,0) rectangle (1,0.5);
\fill[opaque] (0.5,0) rectangle (1.5,0.25); }
```

`/tikz/fill opacity= $\langle value \rangle$`  (no default)

This option sets the opacity of fillings. In addition to filling operations, this opacity also applies to text and images.

Note, again, that when you use PostScript as your output format, this option works only with recent versions of GhostScript.

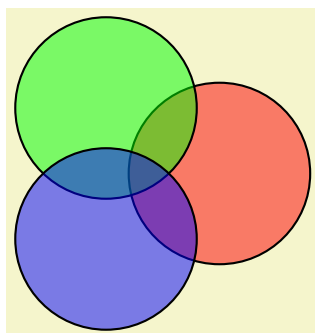

```
\begin{tikzpicture}[thick,fill opacity=0.5]
\filldraw[fill=red] (0:1cm) circle (12mm);
\filldraw[fill=green] (120:1cm) circle (12mm);
\filldraw[fill=blue] (-120:1cm) circle (12mm);
\end{tikzpicture}
```

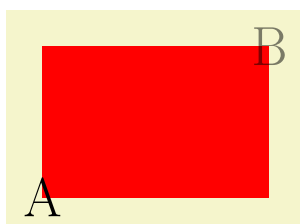

```
\begin{tikzpicture}
\fill[red] (0,0) rectangle (3,2);

\node at (0,0) {\huge A};
\node[fill opacity=0.5] at (3,2) {\huge B};
\end{tikzpicture}
```



`/tikz/text opacity=<value>` (no default)

Sets the opacity of text labels, overriding the `fill opacity` setting.

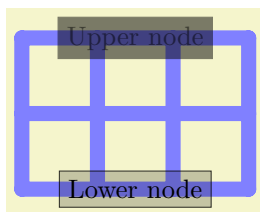

```
\begin{tikzpicture}[every node/.style={fill,draw}]
  \draw[line width=2mm,blue!50,line cap=round] (0,0) grid (3,2);

  \node[opacity=0.5] at (1.5,2) {Upper node};
  \node[draw opacity=0.8,fill opacity=0.2,text opacity=1]
    at (1.5,0) {Lower node};
\end{tikzpicture}
```

Note the following effect: If you setup a certain opacity for stroking or filling and you stroke or fill the same area twice, the effect accumulates:

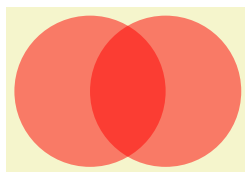

```
\begin{tikzpicture}[fill opacity=0.5]
  \fill[red] (0,0) circle (1);
  \fill[red] (1,0) circle (1);
\end{tikzpicture}
```

Often, this is exactly what you intend, but not always. You can use transparency groups, see the end of this section, to change this.

## 20.3 Fadings

For complicated graphics, uniform transparency settings are not always sufficient. Suppose, for instance, that while you paint a picture, you want the transparency to vary smoothly from completely opaque to completely transparent. This is a “shading-like” transparency. For such a form of transparency I will use the term *fading* (as a noun). They are also known as *soft masks*, *opacity masks*, *masks*, or *soft clips*.

### 20.3.1 Creating Fadings

How do we specify a fading? This is a bit of an art since the underlying mechanism is quite powerful, but a bit difficult to use.

Let us start with a bit of terminology. A *fading* specifies for each point of an area to transparency of the point. This transparency can be any number between 0 and 1. A *fading picture* is a normal graphic that, in a way to be described in a moment, determines the transparency of points inside the fading. Each fading has an underlying fading picture.

The fading picture is a normal graphic drawn using any of the normal graphic drawing commands. A fading and its fading picture are related as follows: Given any point of the fading, the transparency of this point is determined by the luminosity of the fading picture at the same position. The luminosity of a point determines “how bright” the point is. The brighter the point in the fading picture, the more opaque is the point in the fading. In particular, a white point of the fading picture is completely opaque in the fading and a black point of the fading picture is completely transparent in the fading. (The background of the fading picture is always transparent in the fading as if the background were black.)

It is rather counter-intuitive that a *white* pixel of the fading picture will be *opaque* in the fading and a *black* pixel will be *transparent*. For this reason, TikZ defines a color called `transparent` that is the same as `black`. The nice thing about this definition is that the color `transparent!<percentage>` in the fading picture yields a pixel that is *<percentage>* per cent transparent in the fading.

Turning a fading picture into a normal picture is achieved using the following commands, which are *only defined in the library*, namely the library `fadings`. So, to use them, you have to say `\usetikzlibrary{fadings}` first.

```
\begin{tikzfadingfrompicture} [<options>]
  <environment contents>
\end{tikzfadingfrompicture}
```

This command works like a `{tikzpicture}`, only the picture is not shown, but instead a fading is defined based on this picture. To set the name of the picture, use the `name` option (which is normally used to set the name of a node).

`/tikz/name={⟨name⟩}` (no default)

Use this option with the `{tikzfadingfrompicture}` environment to set the name of the fading. You *must* provide this option.

The following shading is 2cm by 2cm and changes gets more and more transparent from left to right, but is 50% transparent for a large circle in the middle.

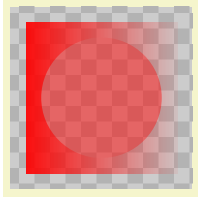

```
\begin{tikzfadingfrompicture}[name=fade right]
  \shade[left color=transparent!0,
          right color=transparent!100] (0,0) rectangle (2,2);
  \fill[transparent!50] (1,1) circle (0.7);
\end{tikzfadingfrompicture}

% Now we use the fading in another picture:
\begin{tikzpicture}
  % Background
  \fill [black!20] (-1.2,-1.2) rectangle (1.2,1.2);
  \pattern [pattern=checkerboard,pattern color=black!30]
    (-1.2,-1.2) rectangle (1.2,1.2);

  \fill [path fading=fade right,red] (-1,-1) rectangle (1,1);
\end{tikzpicture}
```

In the next example we create a fading picture that contains some text. When the fading is used, we only see the shading “through it.”

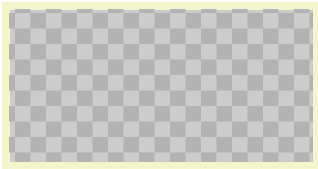

```
\begin{tikzfadingfrompicture}[name=tikz]
  \node [text=transparent!20]
    {\fontfamily{ptm}\fontsize{45}{45}\bfseries\selectfont Ti\emph{k}Z};
\end{tikzfadingfrompicture}

% Now we use the fading in another picture:
\begin{tikzpicture}
  \fill [black!20] (-2,-1) rectangle (2,1);
  \pattern [pattern=checkerboard,pattern color=black!30]
    (-2,-1) rectangle (2,1);

  \shade[path fading=tikz,fit fading=false,
          left color=blue,right color=black]
    (-2,-1) rectangle (2,1);
\end{tikzpicture}
```

`\tikzfadingfrompicture[⟨options⟩]`  
*⟨environment contents⟩*

`\endtikzfadingfrompicture`

The plain $\TeX$  version of the environment.

`\starttikzfadingfrompicture[⟨options⟩]`  
*⟨environment contents⟩*

`\stoptikzfadingfrompicture`

The Con $\TeX$ t version of the environment.

`\tikzfading[⟨options⟩]`

This command is used to define a fading similarly to that way a shading is defined. In the *⟨options⟩* you should

1. use the `name=⟨name⟩` option to set a name for the fading,
2. use the `shading` option to set the name of the shading that you wish to use,
3. extra options for setting the colors of the shading (typically you will set them to the color `transparent!⟨percentage⟩`).

Then, a new fading named *⟨name⟩* will be created based on the shading.

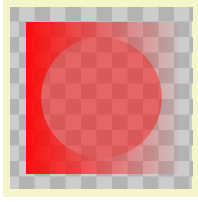

```

\tikzfading[name=fade right,
  left color=transparent!0,
  right color=transparent!100]

% Now we use the fading in another picture:
\begin{tikzpicture}
  % Background
  \fill [black!20] (-1.2,-1.2) rectangle (1.2,1.2);
  \path [pattern=checkerboard,pattern color=black!30]
    (-1.2,-1.2) rectangle (1.2,1.2);

  \fill [red,path fading=fade right] (-1,-1) rectangle (1,1);
\end{tikzpicture}

```

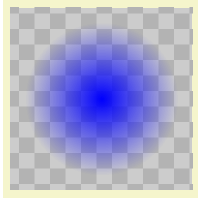

```

\tikzfading[name=fade out,
  inner color=transparent!0,
  outer color=transparent!100]

% Now we use the fading in another picture:
\begin{tikzpicture}
  % Background
  \fill [black!20] (-1.2,-1.2) rectangle (1.2,1.2);
  \path [pattern=checkerboard,pattern color=black!30]
    (-1.2,-1.2) rectangle (1.2,1.2);

  \fill [blue,path fading=fade out] (-1,-1) rectangle (1,1);
\end{tikzpicture}

```

### 20.3.2 Fading a Path

Aa fading specifies for each pixel of a certain area how transparent this pixel will be. The following options are used to install such a fading for the current scope or path.

`/tikz/path fading=<name>` (default scope's setting)

This option tells TikZ that the current path should be faded with the fading *<name>*. If no *<name>* is given, the *<name>* set for the whole scope is used. Similarly to options like `draw` or `fill`, this option is reset for each path, so you have to add it to each path that should be faded. You can also specify `none` as *<name>*, in which case fading for the path will be switched off in case it has been switched on by previous options or styles.

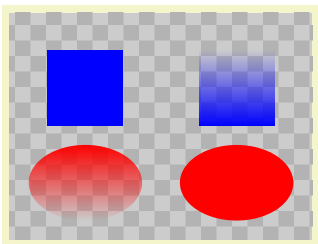

```

\begin{tikzpicture}[path fading=south]
  % Checker board
  \fill [black!20] (0,0) rectangle (4,3);
  \pattern [pattern=checkerboard,pattern color=black!30]
    (0,0) rectangle (4,3);

  \fill [color=blue] (0.5,1.5) rectangle +(1,1);
  \fill [color=blue,path fading=north] (2.5,1.5) rectangle +(1,1);

  \fill [color=red,path fading] (1,0.75) ellipse (.75 and .5);
  \fill [color=red] (3,0.75) ellipse (.75 and .5);
\end{tikzpicture}

```

`/tikz/fit fading=<boolean>` (default true, initially true)

When set to `true`, the fading is shifted and resized (in exactly the same way as a shading) so that it covers the current path. When set to `false`, the fading is only shifted so that it is centered on the path's center, but it is not resized. This can be useful for special-purpose fadings, for instance when you use a fading to "punsh out" something.

`/tikz/fading transform=<transformation options>` (no default)

The *<transformation options>* are applied to the fading before it is used. For instance, if *<transformation options>* is set to `rotate=90`, the fading is rotated by 90 degrees.

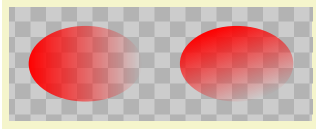

```
\begin{tikzpicture}[path fading=fade down]
% Checker board
\fill [black!20] (0,0) rectangle (4,1.5);
\path [pattern=checkerboard,pattern color=black!30] (0,0) rectangle (4,1.5);

\fill [red,path fading,fading transform={rotate=90}]
(1,0.75) ellipse (.75 and .5);
\fill [red,path fading,fading transform={rotate=30}]
(3,0.75) ellipse (.75 and .5);
\end{tikzpicture}
```

`/tikz/fading angle=degree` (no default)

A shortcut for `fading transform={rotate=degree}`.

Note that you can “fade just about anything.” In particular, you can fade a shading.

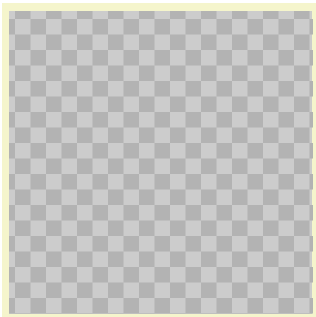

```
\begin{tikzpicture}
% Checker board
\fill [black!20] (0,0) rectangle (4,4);
\path [pattern=checkerboard,pattern color=black!30] (0,0) rectangle (4,4);

\shade [ball color=blue,path fading=south] (2,2) circle (1.8);
\end{tikzpicture}
```

The fade inside of the following example more transparent in the middle than on the outside.

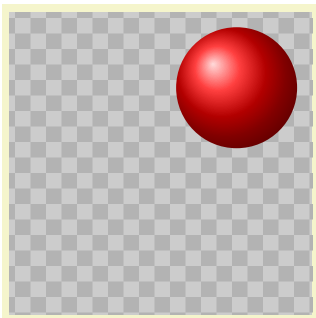

```
\tikzfading[name=fade inside,
inner color=transparent!80,
outer color=transparent!30]
\begin{tikzpicture}
% Checker board
\fill [black!20] (0,0) rectangle (4,4);
\path [pattern=checkerboard,pattern color=black!30] (0,0) rectangle (4,4);

\shade [ball color=red] (3,3) circle (0.8);
\shade [ball color=white,path fading=fade inside] (2,2) circle (1.8);
\end{tikzpicture}
```

Note that adding the `path fading` option to a node fades the (background) path, not the text itself. To fade the text, you need to use a scope fading (see below).

Note that using fadings in conjunction with patterns can create visually rather pleasing effects:

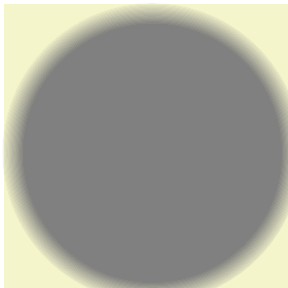

```
\tikzfading[name=middle,
top color=transparent!50,
bottom color=transparent!50,
middle color=transparent!20]
\begin{tikzpicture}
\node [circle,circular drop shadow,
pattern=horizontal lines dark blue,
path fading=south,
minimum size=3.6cm] {};
\pattern [path fading=north,
pattern=horizontal lines dark gray]
(0,0) circle (1.8cm);
\pattern [path fading=middle,
pattern=crosshatch dots light steel blue]
(0,0) circle (1.8cm);
\end{tikzpicture}
```

### 20.3.3 Fading a Scope

In addition to fading individual paths, you may also wish to “fade a scope,” that is, you may wish to install a fading that is used globally to specify the transparency for all objects drawn inside a scope. This effect can also be thought of as a “soft clip” and it works in a similar way: You add the `scope fading` option to a path in a scope – typically the first one – and then all subsequent drawings in the scope are faded. You will use a `transparency group` in conjunction, see the end of this section.

`/tikz/scope fading=fading` (no default)

In principle, this key works in exactly the same way as the `path fading` key. The only difference is, that the effect of the fading will persist after the current path till the end of the scope. Thus, the *fading* is applied to all subsequent drawings in the current scope, not just to the current path. In this regard, the option works very much like the `clip` option. (Note, however, that, unlike the `clip` option, fadings do not accumulate unless a transparency group is used.)

The keys `fit fading` and `fading transform` have the same effect as for `path fading`. Also that, just as for `path fading`, providing the `scope fading` option with a `{scope}` only sets the name of the fading to be used. You have to explicitly provide the `scope fading` with a path to actually install a fading.

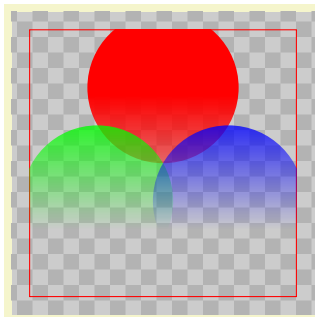

```
\begin{tikzpicture}
  \fill [black!20] (-2,-2) rectangle (2,2);
  \pattern [pattern=checkerboard,pattern color=black!30]
    (-2,-2) rectangle (2,2);

  % The bounding box of the shading:
  \draw [red] (-50bp,-50bp) rectangle (50bp,50bp);

  \path [scope fading=south,fit fading=false] (0,0);
  % fading is centered at its natural size

  \fill[red] ( 90:1) circle (1);
  \fill[green] (210:1) circle (1);
  \fill[blue] (330:1) circle (1);
\end{tikzpicture}
```

In the following example we resize the fading to the size of the whole picture:

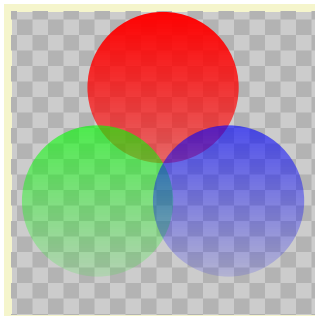

```
\begin{tikzpicture}
  \fill [black!20] (-2,-2) rectangle (2,2);
  \pattern [pattern=checkerboard,pattern color=black!30]
    (-2,-2) rectangle (2,2);

  \path [scope fading=south] (-2,-2) rectangle (2,2);

  \fill[red] ( 90:1) circle (1);
  \fill[green] (210:1) circle (1);
  \fill[blue] (330:1) circle (1);
\end{tikzpicture}
```

Scope fadings are also needed if you wish to fade a node.

This is some text that will fade out as we go right and down. It is pretty hard to achieve this effect in other ways.

```
\tikz \node [scope fading=south,fading angle=45,text width=3.5cm]
{
  This is some text that will fade out as we go right
  and down. It is pretty hard to achieve this effect in
  other ways.
};
```

## 20.4 Transparency Groups

Consider the following cross and sign. They “look wrong” because we can see how they were constructed, while this is not really part of the desired effect.

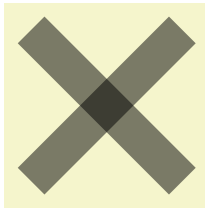

```
\begin{tikzpicture}[opacity=.5]
  \draw [line width=5mm] (0,0) -- (2,2);
  \draw [line width=5mm] (2,0) -- (0,2);
\end{tikzpicture}
```



```
\begin{tikzpicture}
  \node at (0,0) [forbidden sign,line width=2ex,draw=red,fill=white] {Smoking};

  \node [opacity=.5]
    at (2,0) [forbidden sign,line width=2ex,draw=red,fill=white] {Smoking};
\end{tikzpicture}
```

Transparency groups are used to render them correctly:

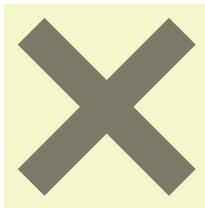

```
\begin{tikzpicture}[opacity=.5]
  \begin{scope}[transparency group]
    \draw [line width=5mm] (0,0) -- (2,2);
    \draw [line width=5mm] (2,0) -- (0,2);
  \end{scope}
\end{tikzpicture}
```

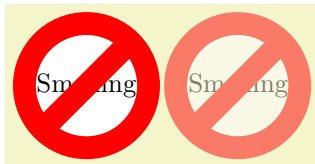

```
\begin{tikzpicture}
  \node at (0,0) [forbidden sign,line width=2ex,draw=red,fill=white] {Smoking};

  \begin{scope}[opacity=.5,transparency group]
    \node at (2,0) [forbidden sign,line width=2ex,draw=red,fill=white]
      {Smoking};
  \end{scope}
\end{tikzpicture}
```

### `/tikz/transparency group`

(no value)

This option can be given to a `scope`. It will have the following effect: The scope's contents is stroked/filled "ignoring any outside transparency." This means, all previous transparency settings are ignored (you can still set transparency inside the group, but never mind). For instance, in the forbidden sign example, the whole sign is first painted (conceptually) like the image on the left hand side. Note that some pixels of the sign are painted multiple times (up to three times), but only the last color "wins."

Then, when the scope is finished, it is painted as a whole. The *fill* transparency settings are now applied to the resulting picture. For instance, the pixel that has been painted three times is just red at the end, so this red color will be blended with whatever is "behind" the group on the page.

Note that, depending on the driver, it is possible to directly put objects in a transparency group that lie outside the picture. This has to do with internal bounding box computations. Section 84 explains how to sidestep this problem.

## 21 Decorated Paths

### 21.1 Overview

Decorations are a general concept to make (sub)paths “more interesting.” Before we have a look at the details, let us have a look at some examples:

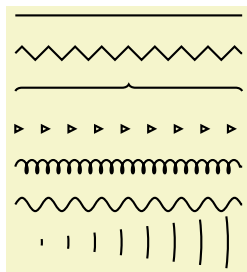

```
\begin{tikzpicture}[thick]
\draw (0,3) -- (3,3);
\draw[decorate,decoration=zigzag] (0,2.5) -- (3,2.5);
\draw[decorate,decoration=brace] (0,2) -- (3,2);
\draw[decorate,decoration=triangles] (0,1.5) -- (3,1.5);
\draw[decorate,decoration={coil,segment length=4pt}] (0,1) -- (3,1);
\draw[decorate,decoration={coil,aspect=0}] (0,.5) -- (3,.5);
\draw[decorate,decoration={expanding waves,angle=7}] (0,0) -- (3,0);
\end{tikzpicture}
```



```
\begin{tikzpicture}
\node [fill=red!20,draw,decorate,decoration={bumps,mirror},
minimum height=1cm]
{Bumpy};
\end{tikzpicture}
```

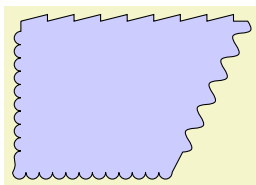

```
\begin{tikzpicture}
\filldraw[fill=blue!20] (0,3)
decorate [decoration=saw] { -- (3,3) }
decorate [decoration={coil,aspect=0}] { -- (2,1) }
decorate [decoration=bumps] { -| (0,3) };
\end{tikzpicture}
```

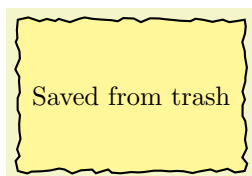

```
\begin{tikzpicture}
\node [fill=yellow!50,draw,thick, minimum height=2cm, minimum width=3cm,
decorate, decoration={random steps,segment length=3pt,amplitude=1pt}]
{Saved from trash};
\end{tikzpicture}
```

The general idea of decorations is the following: First, you construct a path using the usual path construction commands. The resulting path is, in essence, a series of straight and curved lines. Instead of directly using this path for filling or drawing, you can then specify that it should form the basis for a decoration. In this case, depending on which decoration you use, a new path is constructed “along” the path you specified. For instance, with the `zigzag` decoration, the new path is a zigzagging line that goes along the old path.

Let us have a look at an example: In the first picture, we see a path that consists of a line, an arc, and a line. In the second picture, this path has been used as the basis of a decoration.

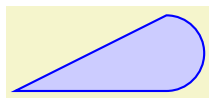

```
\tikz \fill
[fill=blue!20,draw=blue,thick] (0,0) -- (2,1) arc (90:-90:.5) -- cycle;
```



```
\tikz \fill [decorate,decoration={zigzag}]
[fill=blue!20,draw=blue,thick] (0,0) -- (2,1) arc (90:-90:.5) -- cycle;
```

It is also possible to decorate only a subpath (the exact syntax will be explained later in this section).

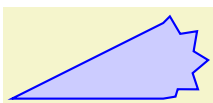

```
\tikz \fill [decoration={zigzag}]
[fill=blue!20,draw=blue,thick] (0,0) -- (2,1)
decorate { arc (90:-90:.5) } -- cycle;
```

The `zigzag` decoration will be called a *path morphing* decoration because it morphs a path into a different, but topologically equivalent path. Not all decorations are path morphing; rather there are three kinds of decorations.

1. The just-mentioned *path morphing* decorations morph the path in the sense that what used to be a straight line might afterwards be a squiggly line or might have bumps. However, a line is still a line and path deforming decorations do not change the number of subpaths.

Examples of such decorations are the `snake` or the `zigzag` decoration. Many such decorations are defined in the library `decorations.pathmorphing`.

2. *Path replacing* decorations completely replace the path by a different path that is only “loosely based” on the original path. For instance, the `crosses` decoration replaces a path by a path consisting of a sequence of crosses. Note how in the following example filling the path has no effect since the path consist only of (numerous) unconnected straight line subpaths:



```
\tikz \fill [decorate,decoration={crosses}]
[fill=blue!20,draw=blue,thick] (0,0) -- (2,1) arc (90:-90:.5) -- cycle;
```

Examples of path replacing decorations are `crosses` or `ticks` or `shape backgrounds`. Such decorations are defined in the library `decorations.pathreplacing`, but also in `decorations.shapes`.

3. *Path removing* decorations completely remove the to-be-decorated path. Thus, they have no effect on the main path that is being constructed. Instead, they typically have numerous *side effects*. For instance, they might “write some text” along the (removed) path or they might place nodes along this path. Note that for such decorations the path usage command for the main path have no influence on how the decoration looks like.

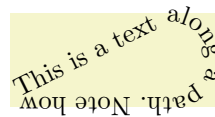

```
\tikz \fill [decorate,decoration={text along path,
text=This is a text along a path. Note how the path is lost.}]
[fill=blue!20,draw=blue,thick] (0,0) -- (2,1) arc (90:-90:.5) -- cycle;
```

Decorations are defined in different decoration libraries, see Section 29 for details. It is also possible to define your own decorations, see Section 72, but you need to use the PGF basic layer and a bit of theory is involved.

Decorations can be used to decorate already decorated paths. In the following three graphics, we start with a simple path, then decorate it once, and then decorate the decorated path once more.

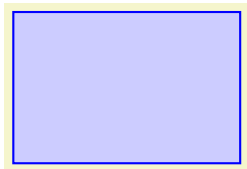

```
\tikz \fill [fill=blue!20,draw=blue,thick]
(0,0) rectangle (3,2);
```

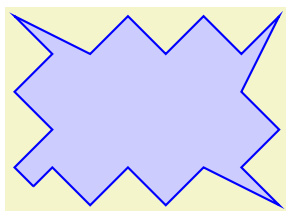

```
\tikz \fill [fill=blue!20,draw=blue,thick]
decorate[decoration={zigzag,segment length=10mm,amplitude=2.5mm}]
{ (0,0) rectangle (3,2) };
```

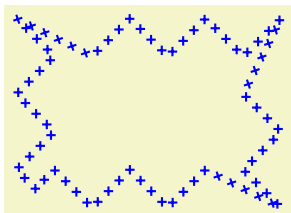

```
\tikz \fill [fill=blue!20,draw=blue,thick]
decorate[decoration={crosses,segment length=2mm}] {
  decorate[decoration={zigzag,segment length=10mm,amplitude=2.5mm}] {
    (0,0) rectangle (3,2)
  }
};
```

One final word of warning: Decorations can be pretty slow to typeset and they can be inaccurate. The reason is that PGF has to a *lot* of rather difficult computations in the background and T<sub>E</sub>X is not very good at doing math. Decorations are fastest when applied to straight line segments, but even then they are much



slower than other alternative. For instance, the `ticks` decoration can be simulated by clever use of a dashing pattern and the dashing pattern will literally be thousands of times faster to typeset. However, for most decorations there are no real alternatives.

```
\usetikzlibrary{decorations} %  $\TeX$  and plain  $\TeX$ 
\usetikzlibrary[decorations] % Con $\TeX$ t
```

In order to use decorations, you first have to load a decoration library. This `decoration` library defines the basic options described in the following, but it does not define any new decorations. This is done by libraries like `decorations.text`. Since these more specialized libraries include the `decoration` library automatically, you usually do not have to bother about it.

## 21.2 Decorating a Subpath Using the Decorate Path Command

The most general way to decorate a (sub)path is the following path command.

```
\path ... decorate[<options>]{<subpath>} ...;
```

This path operation causes the `<subpath>` to be decorated using the current decoration. Depending on the decoration, this may or may not extend the current path.

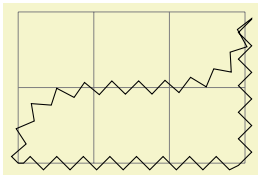

```
\begin{tikzpicture}
\draw [help lines] grid (3,2);
\draw decorate [decoration={name=zigzag}]
  { (0,0) .. controls (0,2) and (3,0) .. (3,2) |- (0,0) };
\end{tikzpicture}
```

The path can include straight lines, curves, rectangles, arcs, circles, ellipses, and even already decorated paths (that is, you can nest applications of the `decorate` path command, see below).

Due to the limits on the precision in  $\TeX$ , some inaccuracies in positioning when crossing input segment boundaries may occasionally be found.

You can use nodes normally inside the `<subpath>`.

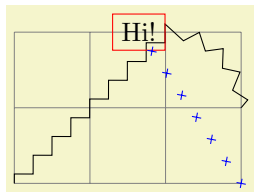

```
\begin{tikzpicture}
\draw [help lines] grid (3,2);
\draw decorate [decoration={name=zigzag}]
  { (0,0) -- (2,2) node (hi) [left,draw=red] {Hi!} arc(90:0:1)};
\draw [blue] decorate [decoration={crosses}] {(3,0) -- (hi)};
\end{tikzpicture}
```

The following key is used to select the decoration and also to select further “rendering options” for the decoration.

```
/pgf/decoration=<decoration options> (no default)
alias /tikz/decoration
```

This option is used to specify which decoration is used and how it will look like. Note that this key will *not* cause any decorations to be applied, immediately. It takes the `decorate` path command or the `decoration` option to actually decorate a path. The `decoration` option is only used to specify which decoration should be used, in principle. You can also use this option at the beginning of a picture or a scope to specify the decoration to be used with each invocation of the `decorate` path command. Naturally, any local options of the `decorate` path command override these “global” options.

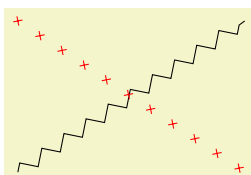

```
\begin{tikzpicture}[decoration=zigzag]
\draw decorate {(0,0) -- (3,2)};
\draw [red] decorate [decoration=crosses] {(0,2) -- (3,0)};
\end{tikzpicture}
```

The `<decoration options>` are special options (which have the path prefix `/pgf/decoration/`) that determine the properties of the decoration. Which options are appropriate for a decoration depend

strongly on the decoration, you will have to look up the appropriate options in the documentation of the decoration, see Section 29.

There is one option (available only in TikZ) that is special:

`/pgf/decoration/name=<name>` (no default, initially **none**)

Use this key to set which decoration is to be used. The *<name>* can both be a decoration or a meta-decoration (you need to worry about the difference only if you wish to define your own decorations).

If you set *<name>* to **none**, no decorations are added.

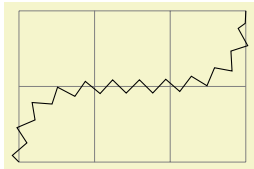

```
\begin{tikzpicture}
\draw [help lines] grid (3,2);
\draw decorate [decoration={name=zigzag}]
{ (0,0) .. controls (0,2) and (3,0) .. (3,2) };
\end{tikzpicture}
```

Since this option is used so often, you can also leave out the **name=** part. Thus, the above example can be rewritten more succinctly:

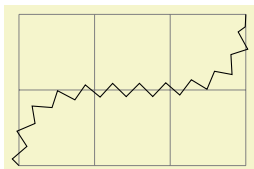

```
\begin{tikzpicture}
\draw [help lines] grid (3,2);
\draw decorate [decoration=zigzag]
{ (0,0) .. controls (0,2) and (3,0) .. (3,2) };
\end{tikzpicture}
```

In general, when *<decoration options>* are parsed, for each unknown key it is checked whether that key happens to be a (meta-)decoration and, if so, the **name** option is executed for this key.

Further options allow you to adjust the position of decorations relative to the to-be-decorated path. See Section 21.4 below for details.

Recall that some decorations actually completely remove the to-be-decorated path. In such cases, the construction of the main path is resumed after the **decorate** path command ends.

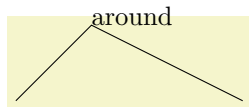

```
\begin{tikzpicture}[decoration={text along path,text=
around and around and around and around we go}]
\draw (0,0) -- (1,1) decorate { -- (2,1) } -- (3,0);
\end{tikzpicture}
```

It is permissible to nest **decorate** commands. In this case, the path resulting from the first decoration process is used as the to-be-decorated path for the second decoration process. This is especially useful for drawing fractals. The Koch **snowflake** decoration replaces a straight line like `_____` by `__/\_`. Repeatedly applying this transformation to a triangle yields a fractal that looks a bit like a snowflake, hence the name.

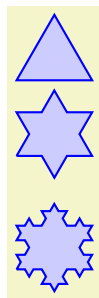

```
\begin{tikzpicture}[decoration=Koch snowflake,draw=blue,fill=blue!20,thick]
\filldraw (0,0) -- ++(60:1) -- ++(-60:1) -- cycle ;
\filldraw decorate{ (0,-1) -- ++(60:1) -- ++(-60:1) -- cycle };
\filldraw decorate{ decorate{ (0,-2.5) -- ++(60:1) -- ++(-60:1) -- cycle }};
\end{tikzpicture}
```

### 21.3 Decorating a Complete Path

You may sometimes wish to decorate a path over whose construction you have no control. For instance, the path of the background of a node is created without your having a chance to issue a **decorate** path

command. In such cases you can use the following option, which allows you to decorate a path “after the fact.”

`/tikz/decorate=<boolean>` (default true)

When this key is set, the whole path is decorated after it has been finished. The decoration used for decorating the path is set via the `decoration` way, in exactly the same way as for the `decorate` path command. Indeed, the following two commands have the same effect:

1. `\path decorate[<options>] {<path>};`
2. `\path [decorate,<options>] <path>;`

The main use of the `decorate` option is that you can also use it with the nodes. It then causes the background path of the node to be decorated. Note that you decorate a background path only once in this manner. That is, in contrast to the `decorate` path command you cannot apply this option twice (this would just set it to `true`, once more).

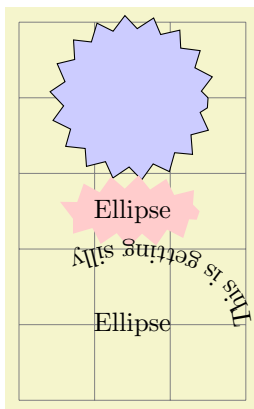

```
\begin{tikzpicture}[decoration=zigzag]
  \draw [help lines] (0,0) grid (3,5);

  \draw [fill=blue!20,decorate] (1.5,4) circle (1cm);

  \node at (1.5,2.5) [fill=red!20,decorate,ellipse] {Ellipse};

  \node at (1.5,1) [inner sep=6mm,fill=red!20,decorate,ellipse,decoration=
    {text along path,text={This is getting silly}}] {Ellipse};
\end{tikzpicture}
```

In the last example, the `text along path` decoration removes the path. In such cases it is useful to use a pre- or postaction to cause the decoration to be applied only before or after the main path has been used. Incidentally, this is another application of the `decorate` option that you cannot achieve with the `decorate` path command.

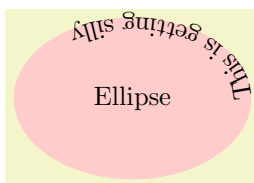

```
\begin{tikzpicture}[decoration=zigzag]
  \node at (1.5,1) [inner sep=6mm,fill=red!20,ellipse,
    postaction={decorate,decoration=
      {text along path,text={This is getting silly}}}] {Ellipse};
\end{tikzpicture}
```

Here is more useful example, where a postaction is used to add the path after the main path has been drawn.

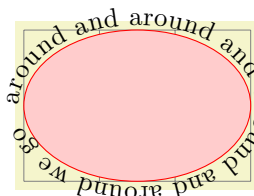

```
\catcode'\|12
\begin{tikzpicture}
  \draw [help lines] grid (3,2);
  \fill [draw=red,fill=red!20,
    postaction={decorate,decoration={raise=2pt,text along path,
      text=around and around and around and around we go}}]
    (0,1) arc (180:-180:1.5cm and 1cm);
\end{tikzpicture}
```

## 21.4 Adjusting Decorations

### 21.4.1 Positioning Decorations Relative to the To-Be-Decorate Path

The following option, which are only available with *TikZ*, allow you to modify the positioning of decorations relative to the to-be-decorated path.

`/pgf/decoration/raise=<dimension>` (no default, initially 0pt)

The segments of the decoration are raised by  $\langle dimension \rangle$  relative to the to-be-decorated path. More precisely, the segments of the path are offset by this much “to the left” of the path as we travel along the path. This raising is done after and in addition to any transformations set using the `transform` option (see below).

A negative  $\langle dimension \rangle$  will offset the decoration “to the right” of the to-be-decorated path.

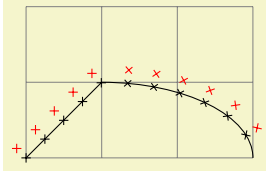

```
\begin{tikzpicture}
\draw [help lines] (0,0) grid (3,2);

\draw (0,0) -- (1,1) arc (90:0:2 and 1);
\draw decorate [decoration=crosses]
{ (0,0) -- (1,1) arc (90:0:2 and 1) };
\draw[red] decorate [decoration={crosses,raise=5pt}]
{ (0,0) -- (1,1) arc (90:0:2 and 1) };
\end{tikzpicture}
```

`/pgf/decoration/mirror= $\langle boolean \rangle$`  (no default)

Causes the segments of the decoration to be mirrored along the to-be-decorated path. This is done after and in addition to any transformations set using the `transform` and/or `raise` options.

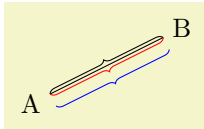

```
\begin{tikzpicture}
\node (a) {A};
\node (b) at (2,1) {B};
\draw (a) -- (b);
\draw[decorate,decoration=brace] (a) -- (b);
\draw[decorate,decoration={brace,mirror},red] (a) -- (b);
\draw[decorate,decoration={brace,mirror,raise=5pt},blue] (a) -- (b);
\end{tikzpicture}
```

`/pgf/decoration/transform= $\langle transformations \rangle$`  (no default)

This key allows you to specify general  $\langle transformations \rangle$  to be applied to the segments of a decoration. These transformations are applied before and independently of `raise` and `mirror` transformations. The  $\langle transformations \rangle$  should be normal TikZ transformations like `shift` or `rotate`.

In the following example the `shift` only transformation is used to make sure that the crosses are *not* sloped along the path.

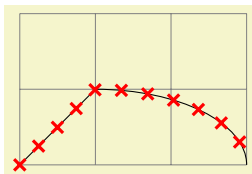

```
\begin{tikzpicture}
\draw [help lines] (0,0) grid (3,2);

\draw (0,0) -- (1,1) arc (90:0:2 and 1);
\draw[red,very thick] decorate [decoration={
crosses,transform={shift only},shape size=1.5mm}]
{ (0,0) -- (1,1) arc (90:0:2 and 1) };
\end{tikzpicture}
```

## 21.4.2 Starting and Ending Decorations Early or Late

You sometimes may wish to “end” a decoration a bit early on the path. For instance, you might wish a `snake` decoration to stop 5mm before the end of the path and to continue in a straight line. There are different ways of achieving this effect, but the easiest may be the `pre` and `post` options, which only have an effect in TikZ. Note, however, that they can only be used with decorations, not with meta-decorations.

`/pgf/decoration/pre= $\langle decoration \rangle$`  (no default, initially `lineto`)

This key sets a decoration that should be used before the main decoration starts. The  $\langle decoration \rangle$  will be used for a length of `pre length`, which 0pt by default. Thus, for the `pre` option to have any effect, you also need to set the `pre length` option.

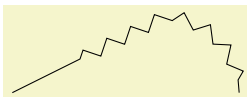

```
\begin{tikzpicture}
\tikz [decoration={zigzag,pre=lineto,pre length=1cm}]
\draw [decorate] (0,0) -- (2,1) arc (90:0:1);
\end{tikzpicture}
```



```
\begin{tikzpicture}
\tikz [decoration={zigzag,pre=moveto,pre length=1cm}]
\draw [decorate] (0,0) -- (2,1) arc (90:0:1);
\end{tikzpicture}
```

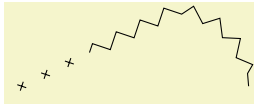

```
\begin{tikzpicture}
\tikz [decoration={zigzag,pre=crosses,pre length=1cm}]
\draw [decorate] (0,0) -- (2,1) arc (90:0:1);
\end{tikzpicture}
```

Note that the default `pre` option is `lineto`, not `curveto`. This means that the default `pre` decoration will not follow curves (for efficiency reasons). Change the `pre` key to `curveto` if you have a curved path.

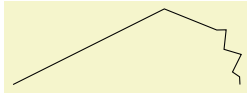

```
\begin{tikzpicture}
\tikz [decoration={zigzag,pre length=3cm}]
\draw [decorate] (0,0) -- (2,1) arc (90:0:1);
\end{tikzpicture}
```

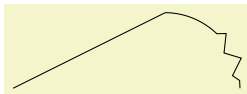

```
\begin{tikzpicture}
\tikz [decoration={zigzag,pre=curveto,pre length=3cm}]
\draw [decorate] (0,0) -- (2,1) arc (90:0:1);
\end{tikzpicture}
```

`/pgf/decoration/pre length=<dimension>` (no default, initially `0pt`)

This key sets the distance along which the pre-decoration should be used. If you do not need/wish a pre-decoration, set this key to `0pt` (exactly this string, not just to something that evaluated to the same things such as `0cm`).

`/pgf/decorations/post=<decoration>` (no default, initially `lineto`)

Works like `pre`, only for the end of the decoration.

`/pgf/decorations/post length=<dimension>` (no default, initially `0pt`)

Works like `pre length`, only for the end of the decoration.

Here is a typical example that shows how these keys can be used:

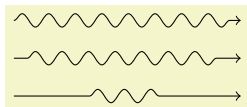

```
\begin{tikzpicture}
[decoration=snake,
line around/.style={decoration={pre length=#1,post length=#1}}]

\draw[->,decorate] (0,0) -- ++(3,0);
\draw[->,decorate,line around=5pt] (0,-5mm) -- ++(3,0);
\draw[->,decorate,line around=1cm] (0,-1cm) -- ++(3,0);
\end{tikzpicture}
```

## 22 Transformations

PGF has a powerful transformation mechanism that is similar to the transformation capabilities of METAFONT. The present section explains how you can access it in TikZ.

### 22.1 The Different Coordinate Systems

It is a long process from a coordinate like, say,  $(1, 2)$  or  $(1\text{cm}, 5\text{pt})$ , to the position a point is finally placed on the display or paper. In order to find out where the point should go, it is constantly “transformed,” which means that it is mostly shifted around and possibly rotated, slanted, scaled, and otherwise mutilated.

In detail, (at least) the following transformations are applied to a coordinate like  $(1, 2)$  before a point on the screen is chosen:

1. PGF interprets a coordinate like  $(1, 2)$  in its  $xy$ -coordinate system as “add the current  $x$ -vector once and the current  $y$ -vector twice to obtain the new point.”
2. PGF applies its coordinate transformation matrix to the resulting coordinate. This yields the final position of the point inside the picture.
3. The backend driver (like `dvips` or `pdftex`) adds transformation commands such the coordinate is shifted to the correct position in  $\text{T}_{\text{E}}\text{X}$ ’s page coordinate system.
4. PDF (or PostScript) apply the canvas transformation matrix to the point, which can once more change the position on the page.
5. The viewer application or the printer applies the device transformation matrix to transform the coordinate to its final pixel coordinate on the screen or paper.

In reality, the process is even more involved, but the above should give the idea: A point is constantly transformed by changes of the coordinate system.

In TikZ, you only have access to the first two coordinate systems: The  $xy$ -coordinate system and the coordinate transformation matrix (these will be explained later). PGF also allows you to change the canvas transformation matrix, but you have to use commands of the core layer directly to do so and you “better know what you are doing” when you do this. The moment you start modifying the canvas matrix, PGF immediately loses track of all coordinates and shapes, anchors, and bounding box computations will no longer work.

### 22.2 The XY- and XYZ-Coordinate Systems

The first and easiest coordinate systems are PGF’s  $xy$ - and  $xyz$ -coordinate systems. The idea is very simple: Whenever you specify a coordinate like  $(2, 3)$  this means  $2v_x + 3v_y$ , where  $v_x$  is the current  $x$ -vector and  $v_y$  is the current  $y$ -vector. Similarly, the coordinate  $(1, 2, 3)$  means  $v_x + 2v_y + 3v_z$ .

Unlike other packages, PGF does not insist that  $v_x$  actually has a  $y$ -component of 0, that is, that it is a horizontal vector. Instead, the  $x$ -vector can point anywhere you want. Naturally, *normally* you will want the  $x$ -vector to point horizontally.

One undesirable effect of this flexibility is that it is not possible to provide mixed coordinates as in  $(1, 2\text{pt})$ . Life is hard.

To change the  $x$ -,  $y$ -, and  $z$ -vectors, you can use the following options:

`/tikz/x= $\langle value \rangle$`  (no default, initially 1cm)

If  $\langle value \rangle$  is a dimension, the  $x$ -vector of PGF’s  $xyz$ -coordinate system is setup to point  $\langle value \rangle$  to the right, that is, to  $(\langle value \rangle, 0\text{pt})$ .

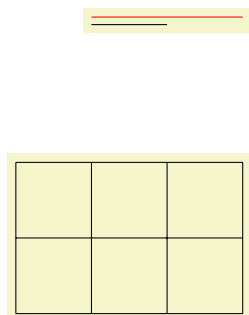

```
\begin{tikzpicture}
\draw (0,0) -- +(1,0);
\draw[x=2cm,color=red] (0,0.1) -- +(1,0);
\end{tikzpicture}
```

```
\tikz \draw[x=1.5cm] (0,0) grid (2,2);
```

The last example shows that the size of steppings in grids, just like all other dimensions, are not affected by the  $x$ -vector. After all, the  $x$ -vector is only used to determine the coordinate of the upper right corner of the grid.

If  $\langle value \rangle$  is a coordinate, the  $x$ -vector of PGF's  $xyz$ -coordinate system to the specified coordinate. If  $\langle value \rangle$  contains a comma, it must be put in braces.



```
\begin{tikzpicture}
  \draw (0,0) -- (1,0);
  \draw[x={(2cm,0.5cm)},color=red] (0,0) -- (1,0);
\end{tikzpicture}
```

You can use this, for example, to exchange the meaning of the  $x$ - and  $y$ -coordinate.

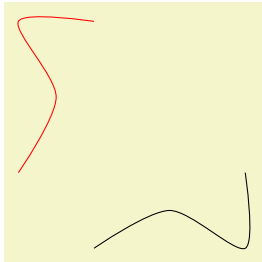

```
\begin{tikzpicture}[smooth]
  \draw plot coordinates{(1,0) (2,0.5) (3,0) (3,1)};
  \draw[x={(0cm,1cm)},y={(1cm,0cm)},color=red]
    plot coordinates{(1,0) (2,0.5) (3,0) (3,1)};
\end{tikzpicture}
```

`/tikz/y= $\langle value \rangle$`  (no default, initially 1cm)

Works like the `x=` option, only if  $\langle value \rangle$  is a dimension, the resulting vector points to  $(0, \langle value \rangle)$ .

`/tikz/z= $\langle value \rangle$`  (no default, initially  $-\sqrt{2}$ cm)

Works like the `y=` option, but now a dimension is means the point  $(\langle value \rangle, \langle value \rangle)$ .

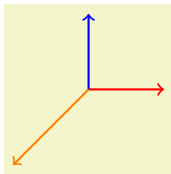

```
\begin{tikzpicture}[z=-1cm,->,thick]
  \draw[color=red] (0,0,0) -- (1,0,0);
  \draw[color=blue] (0,0,0) -- (0,1,0);
  \draw[color=orange] (0,0,0) -- (0,0,1);
\end{tikzpicture}
```

## 22.3 Coordinate Transformations

PGF and TikZ allow you to specify *coordinate transformations*. Whenever you specify a coordinate as  $(1,0)$  or  $(1\text{cm},1\text{pt})$  or  $(30:2\text{cm})$ , this coordinate is first “reduced” to a position of the form “ $x$  points to the right and  $y$  points upwards.” For example,  $(1\text{in},5\text{pt})$  is reduced to “ $72\frac{72}{100}$  points to the right and 5 points upwards” and  $(90:100\text{pt})$  means “0pt to the right and 100 points upwards.”

The next step is to apply the current *coordinate transformation matrix* to the coordinate. For example, the coordinate transformation matrix might currently be set such that it adds a certain constant to the  $x$  value. Also, it might be setup such that it, say, exchanges the  $x$  and  $y$  value. In general, any “standard” transformation like translation, rotation, slanting, or scaling or any combination thereof is possible. (Internally, PGF keeps track of a coordinate transformation matrix very much like the concatenation matrix used by PDF or PostScript.)

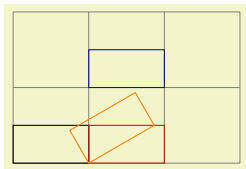

```
\begin{tikzpicture}
  \draw[help lines] (0,0) grid (3,2);
  \draw (0,0) rectangle (1,0.5);
  \begin{scope}[xshift=1cm]
    \draw [red] (0,0) rectangle (1,0.5);
    \draw[yshift=1cm] [blue] (0,0) rectangle (1,0.5);
    \draw[rotate=30] [orange] (0,0) rectangle (1,0.5);
  \end{scope}
\end{tikzpicture}
```

The most important aspect of the coordinate transformation matrix is *that it applies to coordinates only!* In particular, the coordinate transformation has no effect on things like the line width or the dash pattern or the shading angle. In certain cases, it is not immediately clear whether the coordinate transformation matrix *should* apply to a certain dimension. For example, should the coordinate transformation matrix apply to

grids? (It does.) And what about the size of arced corners? (It does not.) The general rule is “If there is no ‘coordinate’ involved, even ‘indirectly,’ the matrix is not applied.” However, sometimes, you simply have to try or look it up in the documentation whether the matrix will be applied.

Setting the matrix cannot be done directly. Rather, all you can do is to “add” another transformation to the current matrix. However, all transformations are local to the current  $\text{\TeX}$ -group. All transformations are added using graphic options, which are described below.

Transformations apply immediately when they are encountered “in the middle of a path” and they apply only to the coordinates on the path following the transformation option.

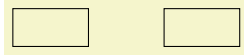

```
\tikz \draw (0,0) rectangle (1,0.5) [xshift=2cm] (0,0) rectangle (1,0.5);
```

A final word of warning: You should refrain from using “aggressive” transformations like a scaling of a factor of 10000. The reason is that all transformations are done using  $\text{\TeX}$ , which has a fairly low accuracy. Furthermore, in certain situations it is necessary that *TikZ* *inverts* the current transformation matrix and this will fail if the transformation matrix is badly conditioned or even singular (if you do not know what singular matrices are, you are blessed).

**/tikz/shift**= $\langle$ *coordinate* $\rangle$  (no default)

Adds the  $\langle$ *coordinate* $\rangle$  to all coordinates.

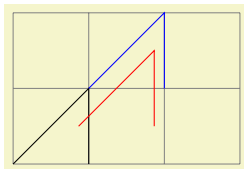

```
\begin{tikzpicture}
\draw[help lines] (0,0) grid (3,2);
\draw (0,0) -- (1,1) -- (1,0);
\draw[shift={(1,1)},blue] (0,0) -- (1,1) -- (1,0);
\draw[shift={(30:1cm)},red] (0,0) -- (1,1) -- (1,0);
\end{tikzpicture}
```

**/tikz/shift only** (no value)

This option does not take any parameter. Its effect is to cancel all current transformations except for the shifting. This means that the origin will remain where it is, but any rotation around the origin or scaling relative to the origin or skewing will no longer have an effect.

This option is useful in situations where a complicated transformation is used to “get to a position,” but you then wish to draw something “normal” at this position.

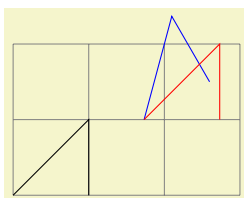

```
\begin{tikzpicture}
\draw[help lines] (0,0) grid (3,2);
\draw (0,0) -- (1,1) -- (1,0);
\draw[rotate=30,xshift=2cm,blue] (0,0) -- (1,1) -- (1,0);
\draw[rotate=30,xshift=2cm,shift only,red] (0,0) -- (1,1) -- (1,0);
\end{tikzpicture}
```

**/tikz/xshift**= $\langle$ *dimension* $\rangle$  (no default)

Adds  $\langle$ *dimension* $\rangle$  to the  $x$  value of all coordinates.

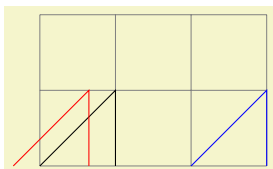

```
\begin{tikzpicture}
\draw[help lines] (0,0) grid (3,2);
\draw (0,0) -- (1,1) -- (1,0);
\draw[xshift=2cm,blue] (0,0) -- (1,1) -- (1,0);
\draw[xshift=-10pt,red] (0,0) -- (1,1) -- (1,0);
\end{tikzpicture}
```

**/tikz/yshift**= $\langle$ *dimension* $\rangle$  (no default)

Adds  $\langle$ *dimension* $\rangle$  to the  $y$  value of all coordinates.

**/tikz/scale**= $\langle$ *factor* $\rangle$  (no default)

Multiplies all coordinates by the given  $\langle$ *factor* $\rangle$ . The  $\langle$ *factor* $\rangle$  should not be excessively large in absolute terms or very near to zero.



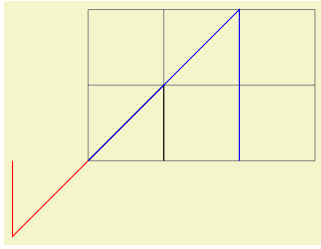

```
\begin{tikzpicture}
\draw[help lines] (0,0) grid (3,2);
\draw (0,0) -- (1,1) -- (1,0);
\draw[scale=2,blue] (0,0) -- (1,1) -- (1,0);
\draw[scale=-1,red] (0,0) -- (1,1) -- (1,0);
\end{tikzpicture}
```

`/tikz/scale around={⟨factor⟩:⟨coordinate⟩}`

(no default)

Scales the coordinate system by  $\langle factor \rangle$ , put with the “origin of scaling” centered on  $\langle coordinate \rangle$  rather than the origin.

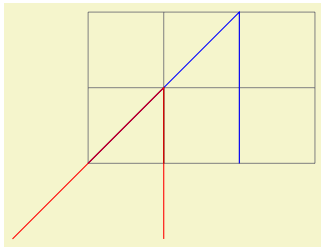

```
\begin{tikzpicture}
\draw[help lines] (0,0) grid (3,2);
\draw (0,0) -- (1,1) -- (1,0);
\draw[scale=2,blue] (0,0) -- (1,1) -- (1,0);
\draw[scale around={2:(1,1)},red] (0,0) -- (1,1) -- (1,0);
\end{tikzpicture}
```

`/tikz/xscale=⟨factor⟩`

(no default)

Multiplies only the  $x$ -value of all coordinates by the given  $\langle factor \rangle$ .

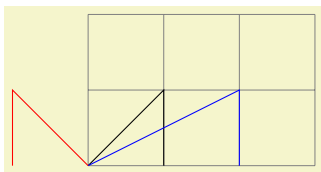

```
\begin{tikzpicture}
\draw[help lines] (0,0) grid (3,2);
\draw (0,0) -- (1,1) -- (1,0);
\draw[xscale=2,blue] (0,0) -- (1,1) -- (1,0);
\draw[xscale=-1,red] (0,0) -- (1,1) -- (1,0);
\end{tikzpicture}
```

`/tikz/yscale=⟨factor⟩`

(no default)

Multiplies only the  $y$ -value of all coordinates by  $\langle factor \rangle$ .

`/tikz/xslant=⟨factor⟩`

(no default)

Slants the coordinate horizontally by the given  $\langle factor \rangle$ :

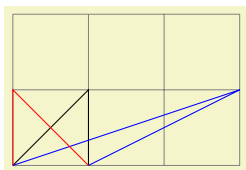

```
\begin{tikzpicture}
\draw[help lines] (0,0) grid (3,2);
\draw (0,0) -- (1,1) -- (1,0);
\draw[xslant=2,blue] (0,0) -- (1,1) -- (1,0);
\draw[xslant=-1,red] (0,0) -- (1,1) -- (1,0);
\end{tikzpicture}
```

`/tikz/yslant=⟨factor⟩`

(no default)

Slants the coordinate vertically by the given  $\langle factor \rangle$ :

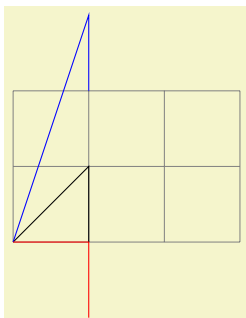

```
\begin{tikzpicture}
\draw[help lines] (0,0) grid (3,2);
\draw (0,0) -- (1,1) -- (1,0);
\draw[yslant=2,blue] (0,0) -- (1,1) -- (1,0);
\draw[yslant=-1,red] (0,0) -- (1,1) -- (1,0);
\end{tikzpicture}
```

`/tikz/rotate=<degree>` (no default)

Rotates the coordinate system by  $\langle degree \rangle$ :

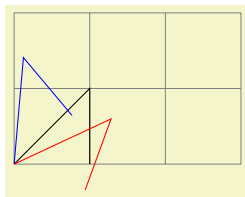

```
\begin{tikzpicture}
\draw[help lines] (0,0) grid (3,2);
\draw (0,0) -- (1,1) -- (1,0);
\draw[rotate=40,blue] (0,0) -- (1,1) -- (1,0);
\draw[rotate=-20,red] (0,0) -- (1,1) -- (1,0);
\end{tikzpicture}
```

`/tikz/rotate around={<degree>:<coordinate>}` (no default)

Rotates the coordinate system by  $\langle degree \rangle$  around the point  $\langle coordinate \rangle$ .

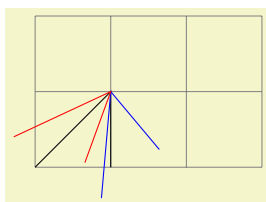

```
\begin{tikzpicture}
\draw[help lines] (0,0) grid (3,2);
\draw (0,0) -- (1,1) -- (1,0);
\draw[rotate around={40:(1,1)},blue] (0,0) -- (1,1) -- (1,0);
\draw[rotate around={-20:(1,1)},red] (0,0) -- (1,1) -- (1,0);
\end{tikzpicture}
```

`/tikz/cm={<a>,<b>,<c>,<d>,<coordinate>}` (no default)

applies the following transformation to all coordinates: Let  $(x, y)$  be the coordinate to be transformed and let  $\langle coordinate \rangle$  specify the point  $(t_x, t_y)$ . Then the new coordinate is given by  $\begin{pmatrix} a & b \\ c & d \end{pmatrix} \begin{pmatrix} x \\ y \end{pmatrix} + \begin{pmatrix} t_x \\ t_y \end{pmatrix}$ . Usually, you do not use this option directly.

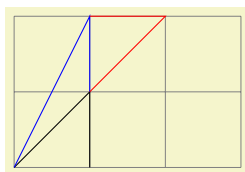

```
\begin{tikzpicture}
\draw[help lines] (0,0) grid (3,2);
\draw (0,0) -- (1,1) -- (1,0);
\draw[cm={1,1,0,1,(0,0)},blue] (0,0) -- (1,1) -- (1,0);
\draw[cm={0,1,1,0,(1cm,1cm)},red] (0,0) -- (1,1) -- (1,0);
\end{tikzpicture}
```

`/tikz/reset cm` (no value)

Completely resets the coordinate transformation matrix to the identity matrix. This will destroy not only the transformations applied in the current scope, but also all transformations inherited from surrounding scopes. Do not use this option, unless you really, really know what you are doing.

## 22.4 Canvas Transformations

A *canvas transformation*, see Section 68.4 for details, is best thought of as a transformation in which the drawing canvas is stretched or rotated. Imaging writing something on a balloon (the canvas) and then blowing air into the balloon: Not only does the text become larger, the thin lines also become larger. In particular, if you scale the canvas by a factor of two, all lines are twice as thick.

Canvas transformations should be used with great care. In most circumstances you do *not* want line widths to change in a picture as this creates visual inconsistency.

Just as important, when you use canvas transformations PGF *loses track of positions of nodes and of picture sizes* since it does not take the effect of canvas transformations into account when it computes coordinates of nodes (you not, however, rely on this; it may change in the future).

Finally, not that a canvas transformation always applies to a path as a whole, it is not possible (as for coordinate transformations) to use different transformations in different parts of a path.

In short, you should not use canvas transformations unless you really know what you are doing.

`/tikz/transform canvas=<options>` (no default)

The  $\langle options \rangle$  should contain coordinate transformations options like `scale` or `xshift`. Multiple options can be given, their effects accumulate in the usual manner. The effect of these  $\langle options \rangle$  (immediately) changes the current canvas transformation matrix. The coordinate transformation matrix is not changed. Tracking of the picture size is (locally) switched off and the node coordinate will no longer be correct.

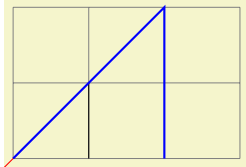

```
\begin{tikzpicture}
  \draw[help lines] (0,0) grid (3,2);
  \draw
    \draw[transform canvas={scale=2},blue] (0,0) -- (1,1) -- (1,0);
    \draw[transform canvas={rotate=180},red] (0,0) -- (1,1) -- (1,0);
\end{tikzpicture}
```

# Part IV

## Libraries

by Till Tantau

In this part the library packages are documented. They provide additional predefined graphic objects like new arrow heads or new plot marks, but also sometimes extensions of the basic PGF or TikZ system. The libraries are not loaded by default since many users will not need them.

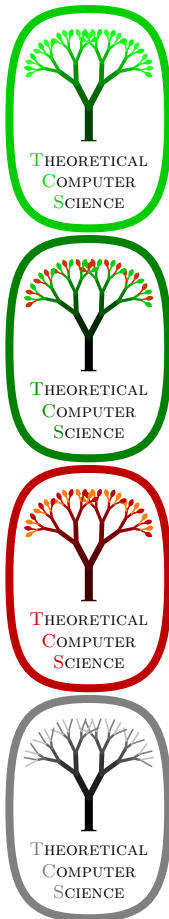

```

\tikzset{
  ld/.style={level distance=#1},lw/.style={line width=#1},
  level 1/.style={ld=4.5mm, trunk, lw=1ex ,sibling angle=60},
  level 2/.style={ld=3.5mm, trunk!80!leaf a,lw=.8ex,sibling angle=56},
  level 3/.style={ld=2.75mm, trunk!60!leaf a,lw=.6ex,sibling angle=52},
  level 4/.style={ld=2mm, trunk!40!leaf a,lw=.4ex,sibling angle=48},
  level 5/.style={ld=1mm, trunk!20!leaf a,lw=.3ex,sibling angle=44},
  level 6/.style={ld=1.75mm,leaf a, lw=.2ex,sibling angle=40},
}
\pgfarrowsdeclare{leaf}{leaf}
{\pgfarrowslefttextend{-2pt} \pgfarrowsrighttextend{1pt}}
{
  \pgfpathmoveto{\pgfpoint{-2pt}{0pt}}
  \pgfpatharc{150}{30}{1.8pt}
  \pgfpatharc{-30}{-150}{1.8pt}
  \pgfusepathqfill
}

\newcommand{\logo}[5]
{
  \colorlet{border}{#1}
  \colorlet{trunk}{#2}
  \colorlet{leaf a}{#3}
  \colorlet{leaf b}{#4}
  \begin{tikzpicture}
    \scriptsize\scshape
    \draw[border,line width=1ex,yshift=.3cm,
      yscale=1.45,xscale=1.05,looseness=1.42]
      (1,0) to [out=90, in=0] (0,1) to [out=180,in=90] (-1,0)
      to [out=-90,in=-180] (0,-1) to [out=0, in=-90] (1,0) -- cycle;

    \coordinate (root) [grow cyclic,rotate=90]
    child {
      child [line cap=round] foreach \a in {0,1} {
        child foreach \b in {0,1} {
          child foreach \c in {0,1} {
            child foreach \d in {0,1} {
              child foreach \leafcolor in {leaf a,leaf b}
                { edge from parent [color=\leafcolor,-#5] }
            } } }
          } edge from parent [shorten >=-1pt,serif cm-,line cap=butt]
        };

        \node [align=center,below] at (0pt,-.5ex)
        { \textcolor{border}{T}heoretical \ \textcolor{border}{C}omputer \ \
          \textcolor{border}{S}cience };
      \end{tikzpicture}
    }
  \begin{minipage}{3cm}
    \logo{green!80!black}{green!25!black}{green}{green!80}{leaf}\ \
    \logo{green!50!black}{black}{green!80!black}{red!80!green}{leaf}\ \
    \logo{red!75!black}{red!25!black}{red!75!black}{orange}{leaf}\ \
    \logo{black!50}{black}{black!50}{black!25}{ }
  \end{minipage}

```

## 23 Arrow Tip Library

```
\usepgflibrary{arrows} %  $\TeX$  and plain  $\TeX$  and pure pgf
\usepgflibrary[arrows] % Con $\TeX$ t and pure pgf
\usetikzlibrary{arrows} %  $\TeX$  and plain  $\TeX$  when using TikZ
\usetikzlibrary[arrows] % Con $\TeX$ t when using TikZ
```

The package defines additional arrow tips, which are described below. Note that neither the standard packages nor this package defines an arrow name containing  $>$  or  $<$ . These are left for the user to defined as he or she sees fit.

The arrow tips `to`, `stealth`, `latex`, `space`, their reversed forms, and `|` are predefined, but listed below for completeness, nevertheless.

### 23.1 Mathematical Arrow Tips

```
to          yields thick  $\longleftrightarrow$  and thin  $\longleftrightarrow$ 
to reversed yields thick  $\rightrightarrows$  and thin  $\leftleftarrows$ 
implies     yields thick  $\implies$  and thin  $\impliedby$ , double  $\iff$  and  $\iff$ 
```











### 23.2 Triangular Arrow Tips

```
latex          yields thick  $\longleftrightarrow$  and thin  $\longleftrightarrow$ , double  $\longleftrightarrow$  and  $\longleftrightarrow$ 
latex reversed yields thick  $\rightrightarrows$  and thin  $\leftleftarrows$ , double  $\rightrightarrows$  and  $\leftleftarrows$ 
latex'        yields thick  $\longleftrightarrow$  and thin  $\longleftrightarrow$ 
latex' reversed yields thick  $\rightrightarrows$  and thin  $\leftleftarrows$ 
stealth       yields thick  $\longleftrightarrow$  and thin  $\longleftrightarrow$ , double  $\longleftrightarrow$  and  $\longleftrightarrow$ 
stealth reversed yields thick  $\rightrightarrows$  and thin  $\leftleftarrows$ , double  $\rightrightarrows$  and  $\leftleftarrows$ 
stealth'      yields thick  $\longleftrightarrow$  and thin  $\longleftrightarrow$ 
stealth' reversed yields thick  $\rightrightarrows$  and thin  $\leftleftarrows$ 
triangle 90   yields thick  $\blacktriangleleft$  and thin  $\blacktriangleright$ 
triangle 90 reversed yields thick  $\blacktriangleright$  and thin  $\blacktriangleleft$ 
triangle 60   yields thick  $\blacktriangleleft$  and thin  $\blacktriangleright$ 
triangle 60 reversed yields thick  $\blacktriangleright$  and thin  $\blacktriangleleft$ 
triangle 45   yields thick  $\blacktriangleleft$  and thin  $\blacktriangleright$ 
triangle 45 reversed yields thick  $\blacktriangleright$  and thin  $\blacktriangleleft$ 
open triangle 90 yields thick  $\triangleleft$  and thin  $\triangleright$ 
open triangle 90 reversed yields thick  $\triangleright$  and thin  $\triangleleft$ 
open triangle 60 yields thick  $\triangleleft$  and thin  $\triangleright$ 
open triangle 60 reversed yields thick  $\triangleright$  and thin  $\triangleleft$ 
open triangle 45 yields thick  $\triangleleft$  and thin  $\triangleright$ 
open triangle 45 reversed yields thick  $\triangleright$  and thin  $\triangleleft$ 
```













### 23.3 Barbed Arrow Tips

```
angle 90      yields thick  $\longleftrightarrow$  and thin  $\longleftrightarrow$ 
angle 90 reversed yields thick  $\rightrightarrows$  and thin  $\leftleftarrows$ 
angle 60      yields thick  $\longleftrightarrow$  and thin  $\longleftrightarrow$ 
angle 60 reversed yields thick  $\rightrightarrows$  and thin  $\leftleftarrows$ 
angle 45      yields thick  $\longleftrightarrow$  and thin  $\longleftrightarrow$ 
angle 45 reversed yields thick  $\rightrightarrows$  and thin  $\leftleftarrows$ 
hooks        yields thick  $\{ \longrightarrow$  and thin  $\{ \longrightarrow$ 
hooks reversed yields thick  $\} \longrightarrow$  and thin  $\} \longrightarrow$ 
```



## 23.4 Bracket-Like Arrow Tips

`[-]` yields thick  and thin   
`]-[` yields thick  and thin   
`(-)` yields thick  and thin   
`)-(` yields thick  and thin   
`|-|` yields thick  and thin 

















## 23.5 Circle, Diamond and Square Arrow Tips

`o` yields thick  and thin   
`*` yields thick  and thin   
`diamond` yields thick  and thin   
`open diamond` yields thick  and thin   
`square` yields thick  and thin   
`open square` yields thick  and thin 







## 23.6 Serif-Like Arrow Tips

`serif cm` yields thick  and thin 

## 23.7 Partial Arrow Tips



`left to` yields thick  and thin   
`left to reversed` yields thick  and thin   
`right to` yields thick  and thin   
`right to reversed` yields thick  and thin   
`left hook` yields thick  and thin   
`left hook reversed` yields thick  and thin   
`right hook` yields thick  and thin   
`right hook reversed` yields thick  and thin 

## 23.8 Line Caps

`round cap` yields for line width 1ex   
`butt cap` yields for line width 1ex   
`triangle 90 cap` yields for line width 1ex   
`triangle 90 cap reversed` yields for line width 1ex   
`fast cap` yields for line width 1ex   
`fast cap reversed` yields for line width 1ex 

## 23.9 Spacing Tips

The spacing arrow tips are useful for combining them with other arrows to get arrows that do not touch the end of the line.

`space` yields thick  and thin 

## 24 Automata Drawing Library

```
\usetikzlibrary{automata} %  $\TeX$  and plain  $\TeX$ 
\usetikzlibrary[automata] % Con $\TeX$ t
```

This packages provides shapes and styles for drawing finite state automata and Turing machines.

### 24.1 Drawing Automata

The automata drawing library is intended to make it easy to draw finite automata and Turing machines. It does not cover every situation imaginable, but most finite automata and Turing machines found in text books can be drawn in a nice and convenient fashion using this library.

To draw an automaton, proceed as follows:

1. For each state of the automaton, there should be one node with the option `state`.
2. To place the states, you can either use absolute positions or relative positions, using options like `above` or `right`.
3. Give a unique name to each state node.
4. Accepting and initial states are indicated by adding the options `accepting` and `initial`, respectively, to the state nodes.
5. Once the states are fixed, the edges can be added. For this, the `edge` operation is most useful. It is, however, also possible to add edges after each node has been placed.
6. For loops, use the `edge [loop]` operation.

Let us now see how this works for a real example. Let us consider a nondeterministic four state automaton that checks whether an contains the sequence  $0^*1$  or the sequence  $1^*0$ .

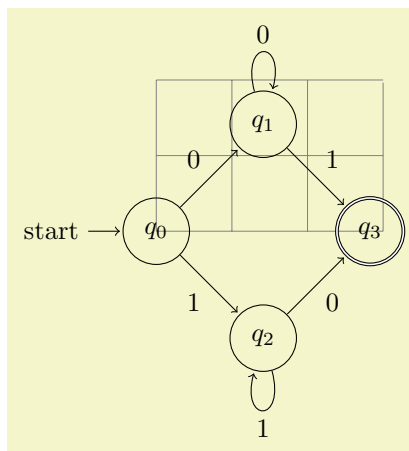

```
\begin{tikzpicture}[shorten >=1pt,node distance=2cm,on grid,auto]
\draw[help lines] (0,0) grid (3,2);

\node[state,initial] (q_0) {}
\node[state] (q_1) [above right=of q_0] {}
\node[state] (q_2) [below right=of q_0] {}
\node[state,accepting] (q_3) [below right=of q_1] {}

\path[->] (q_0) edge node {0} (q_1)
            edge node [swap] {1} (q_2)
            (q_1) edge node {1} (q_3)
            edge [loop above] node {0} ()
            (q_2) edge node [swap] {0} (q_3)
            edge [loop below] node {1} ();
\end{tikzpicture}
```

## 24.2 States With and Without Output

The `state` style actually just “selects” a default underlying style. Thus, you can define multiple new complicated state style and then simply set the `state` style to your given style to get the desired kind of styles.

By default, the following state styles are defined:

`/tikz/state without output` (style, no value)

This node style causes nodes to be drawn circles. Also, this style calls `every state`.

`/tikz/state with output` (style, no value)

This node style causes nodes to be drawn as split circles, that is, using the `circle split` shape. In the upper part of the shape you have the name of the style, in the lower part the output is placed. To specify the output, use the command `\nodepart{lower}` inside the node. This style also calls `every state`.

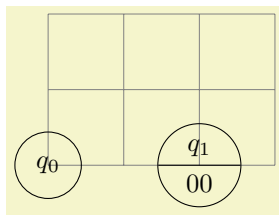

```
\begin{tikzpicture}
  \draw[help lines] (0,0) grid (3,2);

  \node[state without output] {$q_0$};

  \node[state with output] at (2,0) {$q_1$ \nodepart{lower} $00$};
\end{tikzpicture}
```

`/tikz/state` (style, initially state without output)

You should redefine it to something else, if you wish to use states of a different nature.

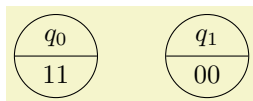

```
\begin{tikzpicture}[state/.style=state with output]
  \node[state] {$q_0$ \nodepart{lower} $11$};
  \node[state] at (2,0) {$q_1$ \nodepart{lower} $00$};
\end{tikzpicture}
```

`/tikz/every state` (style, initially empty)

This style is used by `state with output` and also by `state without output`. By default, it does nothing, but you can use it to make your state look more fancy:

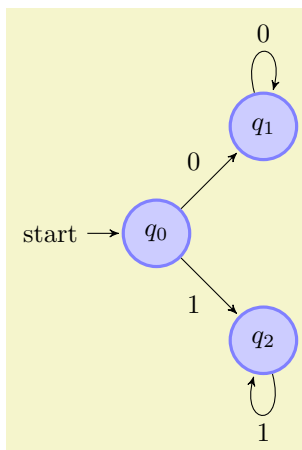

```
\begin{tikzpicture}[shorten >=1pt,node distance=2cm,on grid,>=stealth',
  every state/.style={draw=blue!50,very thick,fill=blue!20}]

  \node[state,initial] (q_0) {$q_0$};
  \node[state] (q_1) [above right=of q_0] {$q_1$};
  \node[state] (q_2) [below right=of q_0] {$q_2$};

  \path[->] (q_0) edge node [above left] {0} (q_1)
             (q_0) edge node [below left] {1} (q_2)
             (q_1) edge [loop above] node {0} ()
             (q_2) edge [loop below] node {1} ();
\end{tikzpicture}
```

## 24.3 Initial and Accepting States

The styles `initial` and `accepting` are similar to the `state` style as they also just select an “underlying” style, which installs the actual settings for initial and accepting states.

Let us start with the initial states.

`/tikz/initial` (style, initially initial by arrow)

This style is used to draw initial states.



`/tikz/initial by arrow` (style, no value)

This style causes an arrow and, possibly, some text to be added to the node. The arrow points from the text to the node. The node text and the direction and the distance can be set using the following key:

`/tikz/initial text=<text>` (no default, initially `start`)

This key sets the text to be used. Use an empty text to suppress all text.

`/tikz/initial where=<direction>` (no default, initially `left`)

Set the place where the text should be shown. Allowed values are `above`, `below`, `left`, and `right`.

`/tikz/initial distance=<distance>` (no default, initially `3ex`)

Sets the length of the arrow leading from the text to the state node.

`/tikz/every initial by arrow` (style, initially empty)

This style is executed at the beginning of every path that contains the arrow and the text. You can use it to, say, make the text red or whatever.

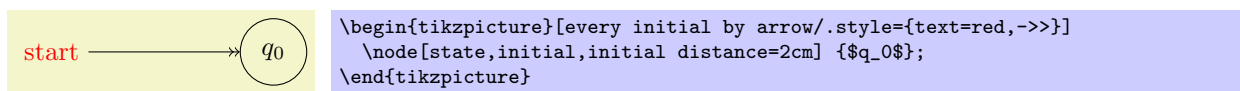

`/tikz/initial above` (style, no value)

This is a shorthand for `initial by arrow,initial where=above`.

`/tikz/initial below` (style, no value)

Works similarly to the previous option.

`/tikz/initial left` (style, no value)

Works similarly to the previous option.

`/tikz/initial right` (style, no value)

Works similarly to the previous option.

`/tikz/initial by diamond` (style, no value)

This style uses a diamond to indicate an initial node.

For the accepting states, the situation is similar: There is also an `accepting` style that selects the way accepting states are rendered. There are now two options: First, `accepting by arrow`, which works the same way as `initial by arrow`, only with the direction of arrow reversed, and `accepting by double`, where accepting states get a double line around them.

`/tikz/accepting` (style, initially `accepting by double`)

This style is used to draw accepting states. You can replace this by the style `accepting by arrow` to get accepting states with an arrow leaving them.

`/tikz/accepting by double` (style, no value)

This style causes a double line to be drawn around a state.

`/tikz/accepting by arrow` (style, no value)

This style causes an arrow and, possibly, some text to be added to the node. The arrow points to the text from the node.

The same options as for initial states can be used, only with `initial` replaced by `accepting`:

`/tikz/accepting text=<text>` (no default, initially empty)

This key sets the text to be used.

`/tikz/accepting where=<direction>` (no default, initially `right`)

Set the place where the text should be shown. Allowed values are `above`, `below`, `left`, and `right`.

`/tikz/intial distance=<distance>` (no default, initially 3ex)

Sets the length of the arrow leading from the text to the state node.

`/tikz/every accepting by arrow` (style, initially empty)

Executed at the beginning of every path that contains the arrow and the text.

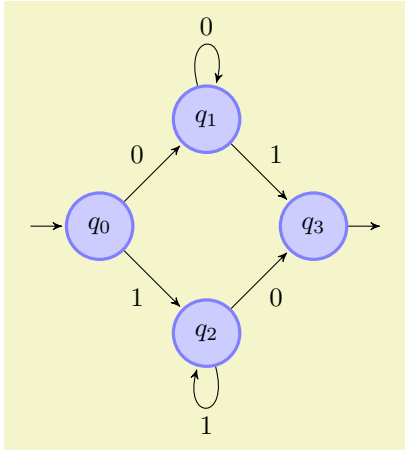

```
\begin{tikzpicture}
[shorten >=1pt,node distance=2cm,on grid,>=stealth',initial text=,
every state/.style={draw=blue!50,very thick,fill=blue!20},
accepting/.style=accepting by arrow]

\node[state,initial] (q_0)          {$q_0$};
\node[state]        (q_1) [above right=of q_0] {$q_1$};
\node[state]        (q_2) [below right=of q_0] {$q_2$};
\node[state,accepting] (q_3) [below right=of q_1] {$q_3$};

\path[->] (q_0) edge          node [above left] {0} (q_1)
            edge          node [below left] {1} (q_2)
            (q_1) edge          node [above right] {1} (q_3)
            edge [loop above] node {0} ()
            (q_2) edge          node [below right] {0} (q_3)
            edge [loop below] node {1} ();
\end{tikzpicture}
```

`/tikz/accepting above` (style, no value)

This is a shorthand for `accepting by arrow,accepting where=above`.

`/tikz/accepting below` (style, no value)

Works similarly to the previous option.

`/tikz/accepting left` (style, no value)

Works similarly to the previous option.

`/tikz/accepting right` (style, no value)

Works similarly to the previous option.

## 24.4 Examples

In the following example, we once more typeset the automaton presented in the previous sections. This time, we use the following rule for accepting/initial state: Initial states are red, accepting states are green, and normal states are orange. Then, we must find a path from a red state to a green state.

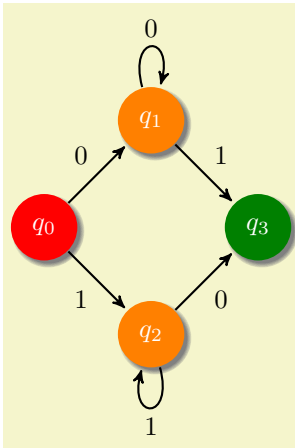

```

\begin{tikzpicture}[shorten >=1pt,node distance=2cm,on grid,>=stealth',thick,
every state/.style={fill,draw=none,orange,text=white,circular drop shadow},
accepting/.style={green!50!black,text=white},
initial/.style={red,text=white}]

\node[state,initial] (q_0) {$q_0$};
\node[state] (q_1) [above right=of q_0] {$q_1$};
\node[state] (q_2) [below right=of q_0] {$q_2$};
\node[state,accepting] (q_3) [below right=of q_1] {$q_3$};

\path[->] (q_0) edge node [above left] {0} (q_1)
edge node [below left] {1} (q_2)
(q_1) edge node [above right] {1} (q_3)
edge [loop above] node {0} ()
(q_2) edge node [below right] {0} (q_3)
edge [loop below] node {1} ();
\end{tikzpicture}

```

The next example is the current candidate for the five-state busiest beaver:

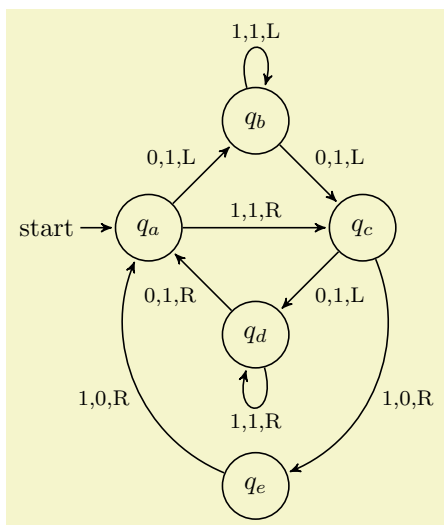

```

\begin{tikzpicture}[->,>=stealth',shorten >=1pt,%
auto,node distance=2cm,on grid,semithick,
inner sep=2pt,bend angle=45]
\node[initial,state] (A) {$q_a$};
\node[state] (B) [above right=of A] {$q_b$};
\node[state] (D) [below right=of A] {$q_d$};
\node[state] (C) [below right=of B] {$q_c$};
\node[state] (E) [below=of D] {$q_e$};

\path [every node/.style={font=\footnotesize}]
(A) edge node {0,1,L} (B)
edge node {1,1,R} (C)
(B) edge [loop above] node {1,1,L} (B)
edge node {0,1,L} (C)
(C) edge node {0,1,L} (D)
edge [bend left] node {1,0,R} (E)
(D) edge [loop below] node {1,1,R} (D)
edge node {0,1,R} (A)
(E) edge [bend left] node {1,0,R} (A);
\end{tikzpicture}

```

## 25 Background Library

```
\usetikzlibrary{backgrounds} %  $\LaTeX$  and plain  $\TeX$ 
\usetikzlibrary[backgrounds] % Con $\TeX$ t
```

This library defines “backgrounds” for pictures. This does not refer to background pictures, but rather to frames drawn around and behind pictures. For example, this package allows you to just add the `framed` option to a picture to get a rectangular box around your picture or `gridded` to put a grid behind your picture.

When this package is loaded, the following styles become available:

`/tikz/show background rectangle` (style, no value)

This style causes a rectangle to be drawn behind your graphic. This style option must be given to the `{tikzpicture}` environment or to the `\tikz` command.

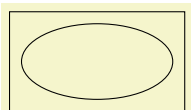

```
\begin{tikzpicture}[show background rectangle]
\draw (0,0) ellipse (10mm and 5mm);
\end{tikzpicture}
```

The size of the background rectangle is determined as follows: We start with the bounding box of the picture. Then, a certain separator distance is added on the sides. This distance can be different for the  $x$ - and  $y$ -directions and can be set using the following options:

`/tikz/inner frame xsep= $\langle$ dimension $\rangle$`  (no default, initially `1ex`)

Sets the additional horizontal separator distance for the background rectangle.

`/tikz/inner frame ysep= $\langle$ dimension $\rangle$`  (no default, initially `1ex`)

Same for the vertical separator distance.

`/tikz/inner frame sep= $\langle$ dimension $\rangle$`  (no default)

Sets the horizontal and vertical separator distances simultaneously.

The following two styles make setting the inner separator a bit easier to remember:

`/tikz/tight background` (style, no value)

Sets the inner frame separator to `0pt`. The background rectangle will have the size of the bounding box.

`/tikz/loose background` (style, no value)

Sets the inner frame separator to `2ex`.

You can influence how the background rectangle is rendered by setting the following style:

`/tikz/background rectangle` (style, initially `draw`)

This style dictates how the background rectangle is drawn or filled. The default setting causes the path of the background rectangle to be drawn in the usual way. Setting this style to, say, `fill=blue!20` causes a light blue background to be added to the picture. You can also use more fancy settings as shown in the following example:

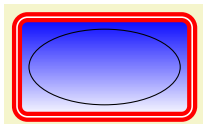

```
\begin{tikzpicture}
[background rectangle/.style=
{double,ultra thick,draw=red,top color=blue,rounded corners},
show background rectangle]
\draw (0,0) ellipse (10mm and 5mm);
\end{tikzpicture}
```

Naturally, no one in their right mind would use the above, but here is a nice background:

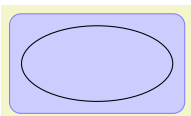

```
\begin{tikzpicture}
[background rectangle/.style=
{draw=blue!50,fill=blue!20,rounded corners=1ex},
show background rectangle]
\draw (0,0) ellipse (10mm and 5mm);
\end{tikzpicture}
```

`/tikz/framed` (style, no value)

This is a shorthand for `show background rectangle`.

`/tikz/show background grid` (style, no value)

This style behaves similarly to the `show background rectangle` style, but it will not use a rectangle path, but a grid. The lower left and upper right corner of the grid is computed in the same way as for the background rectangle:

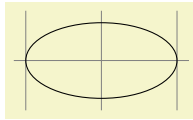

```
\begin{tikzpicture}[show background grid]
  \draw (0,0) ellipse (10mm and 5mm);
\end{tikzpicture}
```

You can influence the background grid by setting the following style:

`/tikz/background grid` (style, initially `draw,help lines`)

This style dictates how the background grid path is drawn.

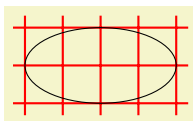

```
\begin{tikzpicture}
  [background grid/.style={thick,draw=red,step=.5cm},
  show background grid]
  \draw (0,0) ellipse (10mm and 5mm);
\end{tikzpicture}
```

This option can be combined with the `framed` option (use the `framed` option first):

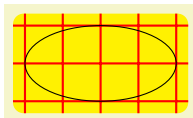

```
\tikzset{background grid/.style={thick,draw=red,step=.5cm},
  background rectangle/.style={rounded corners,fill=yellow}}
\begin{tikzpicture}[framed,gridded]
  \draw (0,0) ellipse (10mm and 5mm);
\end{tikzpicture}
```

`/tikz/gridded` (style, no value)

This is a shorthand for `show background grid`.

`/tikz/show background top` (style, no value)

This style causes a single line to be drawn at the top of the background rectangle. Normally, the line coincides exactly with the top line of the background rectangle:

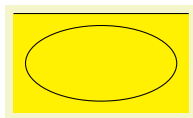

```
\begin{tikzpicture}[
  background rectangle/.style={fill=yellow},
  framed,show background top]
  \draw (0,0) ellipse (10mm and 5mm);
\end{tikzpicture}
```

The following option allows you to lengthen (or shorten) the line:

`/tikz/outer frame xsep= $\langle dimension \rangle$`  (no default, initially 0pt)

The  $\langle dimension \rangle$  is added at the left and right side of the line.

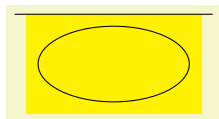

```
\begin{tikzpicture}
  [background rectangle/.style={fill=yellow},
  framed,
  show background top,
  outer frame xsep=1ex]
  \draw (0,0) ellipse (10mm and 5mm);
\end{tikzpicture}
```

`/tikz/outer frame ysep= $\langle dimension \rangle$`  (no default, initially 0pt)

This option does not apply to the top line, but to the left and right lines, see below.

`/tikz/outer frame sep= $\langle dimension \rangle$`  (no default)

Sets both the  $x$ - and  $y$ -separation.

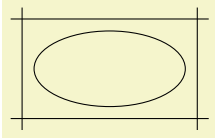

```
\begin{tikzpicture}
[background rectangle={fill=blue!20},
outer frame sep=1ex,%
show background top,%
show background bottom,%
show background left,%
show background right]
\draw (0,0) ellipse (10mm and 5mm);
\end{tikzpicture}
```

You can influence how the line is drawn grid by setting the following style:

`/tikz/background top`

(style, initially draw)

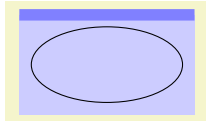

```
\tikzset{background rectangle/.style={fill=blue!20},
background top/.style={draw=blue!50,line width=1ex}}
\begin{tikzpicture}[framed,show background top]
\draw (0,0) ellipse (10mm and 5mm);
\end{tikzpicture}
```

`/tikz/show background bottom`

(style, no value)

Works like the style for the top line.

`/tikz/show background left`

(style, no value)

Works similarly.

`/tikz/show background right`

(style, no value)

Works similarly.

## 26 Calendar Library

```
\usetikzlibrary{calendar} %  $\TeX$  and plain  $\TeX$ 
\usetikzlibrary[calendar] % Con $\TeX$ t
```

The library defines the `\calendar` command, which can be used to typeset calendars. The command relies on the `\pgfcalendar` command from the `pgfcalendar` package, which is loaded automatically.

The `\calendar` command is quite configurable, allowing you to produce all kinds of different calendars.

### 26.1 Calendar Command

The core command for creating calendars in TikZ is the `\calendar` command. It is available only inside `{tikzpicture}` environments (similar to, say, the `\draw` command).

```
\calendar(calendar specification);
```

The syntax for this command is similar to commands like `\node` or `\matrix`. However, it has its complete own parser and only those commands described in the following will be recognized, nothing else. Note, furthermore, that a *(calendar specification)* is not a path specification, indeed, no path is created for the calendar.

**The specification syntax.** The *(calendar specification)* must be a sequence of elements, each of which has one of the following structures:

- [*(options)*]  
You provide *(options)* in square brackets as in `[red,draw=none]`. These *(options)* can be any TikZ option and they apply to the whole calendar. You can provide this element multiple times, the effect accumulates.
- (*(name)*)  
This has the same effect as saying `[name=(name)]`. The effect of providing a *(name)* is explained later. Note already that *a calendar is not a node* and the *(name)* is *not the name of a node*.
- at (*(coordinate)*)  
This has the same effect as saying `[at=(coordinate)]`.
- if (*(date condition)*) *(options or commands)* else *(else options or commands)*  
The effect of such an `if` is explained later.

At the beginning of every calendar, the following style is used:

```
/tikz/every calendar (style, initially empty)
```

This style is used with every calendar.

**The date range.** The overall effect of the `\calendar` command is to execute code for each day of a range of dates. This range of dates is set using the following option:

```
/tikz/dates=(start date) to (end date) (no default)
```

This option specifies the date range. Both the start and end date are specified as described on page 505. In short: You can provide ISO-format type dates like `2006-01-02`, you can replace the day of month by `last` to refer to the last day of a month (so `2006-02-last` is the same as `2006-02-28`), and you can add a plus sign followed by a number to specify an offset (so `2006-01-01+-1` is the same as `2005-12-31`).

It will be useful to fix two pieces of terminology for the following descriptions: The `\calendar` command iterates over the dates in the range. The *current date* refers to the current date the command is processing as it iterates over the dates. For each current date code is executed, which will be called the *current date code*. The current date code consists of different parts, to be detailed later.

The central part of the current date code is the execution of the code `\tikzdaycode`. By default, this code simply produces a node whose text is set to the day of month. This means that unless further action is taken, all days of a calendar will be put on top of each other! To avoid this, you must modify the current date code to shift days around appropriately. Predefined arrangements like `day list downward` or `week list` do this for you, but you can define arrangements yourself. Since defining an arrangement

is a bit tricky, it is explained only later on. For the time being, let us use a predefined arrangement to produce our first calendar:

```

          1 2
    3 4 5 6 7 8 9
  10 11 12 13 14 15 16
  17 18 19 20 21 22 23
  24 25 26 27 28 29 30
  31

```

```
\tikz \calendar[dates=2000-01-01 to 2000-01-31,week list];
```

**Changing the spacing.** In the above calendar, the spacing between the days is determined by the numerous options. Most arrangement do not use all of these options, but only those that apply naturally.

`/tikz/day xshift=<dimension>` (no default, initially 3.5ex)

Specifies the horizontal shift between days. This is not the gap between days, but the shift between the anchors of their nodes.

```

          1 2
    3 4 5 6 7 8 9
  10 11 12 13 14 15 16
  17 18 19 20 21 22 23
  24 25 26 27 28 29 30
  31

```

```
\tikz \calendar[dates=2000-01-01 to 2000-01-31,week list,day xshift=3ex];
```

`/tikz/day yshift=<dimension>` (no default, initially 3ex)

Specifies the vertical shift between days. Again, this is the shift between the anchors of their nodes.

```

    3 4 5 6 7 8 9
  10 11 12 13 14 15 16
  17 18 19 20 21 22 23
  24 25 26 27 28 29 30
  31

```

```
\tikz \calendar[dates=2000-01-01 to 2000-01-31,week list,day yshift=2ex];
```

`/tikz/month xshift=<dimension>` (no default)

Specifies an additional horizontal shift between different months.

`/tikz/month yshift=<dimension>` (no default)

Specifies an additional vertical shift between different months.

```

          1 2
    3 4 5 6 7 8 9
  10 11 12 13 14 15 16
  17 18 19 20 21 22 23
  24 25 26 27 28 29 30
  31 1 2 3 4 5 6
    7 8 9 10 11 12 13
  14 15 16 17 18 19 20
  21 22 23 24 25 26 27
  28 29

```

```
\tikz \calendar[dates=2000-01-01 to 2000-02-last,week list,month yshift=0pt];
```



```

          1 2
    3 4 5 6 7 8 9
  10 11 12 13 14 15 16
  17 18 19 20 21 22 23
  24 25 26 27 28 29 30
  31

    1 2 3 4 5 6
    7 8 9 10 11 12 13
  14 15 16 17 18 19 20
  21 22 23 24 25 26 27
  28 29

```

```
\tikz \calendar[dates=2000-01-01 to 2000-02-last,week list,
month yshift=1cm];
```

**Changing the position of the calendar.** The calendar is placed in such a way that, normally, the anchor of the first day label is at the origin. This can be changed by using the `at` option. When you say `at={(1,1)}`, this anchor of the first day will lie at coordinate (1,1).

In general, arrangements will not always place the anchor of the first day at the origin. Sometimes, additional spacing rules get in the way. There are different ways of addressing this problem: First, you can just ignore it. Since calendars are often placed in their own `{tikzpicture}` and since their size is computed automatically, the exact position of the origin often does not matter at all. Second, you can put the calendar inside a node as in `...node {\tikz \calendar...}`. This allows you to position the node in the normal ways using the node's anchors. Third, you can be very clever and use a single-cell matrix. The advantage is that a matrix allows you to provide any anchor of any node inside the matrix as an anchor for the whole matrix. For example, the following calendar is placed in such a way the center of 2000-01-20 lies on the position (2,2):

```

          1 2
    3 4 5 6 7 8 9
  10 11 12 13 14 15 16
  17 18 19 20 21 22 23
  24 25 26 27 28 29 30
  31

```

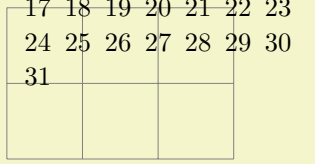

```
\begin{tikzpicture}
\draw[help lines] (0,0) grid (3,2);
\matrix [anchor=cal-2000-01-20.center] at (2,2)
{ \calendar(cal)[dates=2000-01-01 to 2000-01-31,week list]; \\\};
\end{tikzpicture}
```

Unfortunately, the matrix-base positions, which is the cleanest way, is not as portable as the other approaches (it currently does not work with the SVG backend for instance).

**Changing the appearance of days.** As mentioned before, each day in the above calendar is produced by an execution of the `\tikzdaycode`. Each time this code is executed, the coordinate system will have been setup appropriately to place the day of the month correctly. You can change both the code and its appearance using the following options.

`/tikz/day code=<code>` (no default, initially see below)

This option allows you to change the code that is executed for each day. The default is to create a node with an appropriate name, but you can change this:

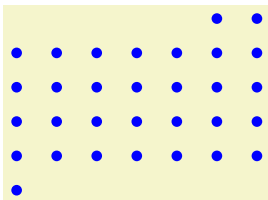

```
\tikz \calendar[dates=2000-01-01 to 2000-01-31,week list,
day code={\fill[blue] (0,0) circle (2pt)}];
```

The default code is the following:

```
\node[name=\pgfcalendarsuggestedname, every day]{\tikzdaytext};
```

The first part causes the day nodes to be accessible via the following names: If  $\langle name \rangle$  is the name given to the calendar via a `name=` option or via the specification element  $\langle (name) \rangle$ , then `\pgfcalendarsuggestedname` will expand to  $\langle name \rangle - \langle date \rangle$ , where  $\langle date \rangle$  is the date of the day that is currently being processed in ISO format .

For example, if January 1, 2006 is being processed and the calendar has been named `mycal`, then the node containing the 1 for this date will be named `mycal-2006-01-01`. You can later reference this node.

```

          1 2
3 4 5 6 7 8 9
10 11 12 13 14 15 16
17 18 19 20 21 22 23
24 25 26 27 28 29 30
31

```

```
\begin{tikzpicture}
  \calendar (mycal) [dates=2000-01-01 to 2000-01-31, week list];

  \draw[red] (mycal-2000-01-20) circle (4pt);
\end{tikzpicture}
```

`/tikz/day text= $\langle text \rangle$`  (no default)

This option changes the setting of the `\tikzdaytext`. By default, this macro simply yields the current day of month, but you can change it arbitrarily. Here is a silly example:

```

          x x
x x x x x x x
x x x x x x x
x x x x x x x
x x x x x x x
x

```

```
\tikz \calendar[dates=2000-01-01 to 2000-01-31, week list,
  day text=x];
```

More useful examples are based on using the `\%` command. This command is redefined inside a `\pgfcalendar` to mean the same as `\pgfcalendarshorthand`. (The original meaning of `\%` is lost inside the calendar, you need to save it before the calendar if you really need it.)

The `\%` inserts the current day/month/year/day of week in a certain format into the text. The first letter following the `\%` selects the type (permissible values are `d`, `m`, `y`, `w`), the second letter specifies how the value should be displayed (`-` means numerically, `=` means numerically with leading space, `0` means numerically with leading zeros, `t` means textual, and `.` means textual, abbreviated). For example `\%d0` gives the day with a leading zero (for more details see the description of `\pgfcalendarshorthand` on page 510).

Let us redefine the `day text` so that it yields the day with a leading zero:

```

          01 02
03 04 05 06 07 08 09
10 11 12 13 14 15 16
17 18 19 20 21 22 23
24 25 26 27 28 29 30
31

```

```
\tikz \calendar[dates=2000-01-01 to 2000-01-31, week list,
  day text=\%d0];
```

`/tikz/every day (initially anchor=base east)` (style, no default)

This style is executed by the default node code for each day. The `every day` style is useful for changing the way days look. For example, let us make all days red:

```

1 2
3 4 5 6 7 8 9
10 11 12 13 14 15 16
17 18 19 20 21 22 23
24 25 26 27 28 29 30
31

```

```

\tikz[every day/.style=red]
\calendar[dates=2000-01-01 to 2000-01-31,week list];

```

**Changing the appearance of month and year labels.** In addition to the days of a calendar, labels for the months and even years (for really long calendars) can be added. These labels are only added once per month or year and this is not done by default. Rather, special styles starting with `month label` place these labels and make them visible:

```

January
1 2
3 4 5 6 7 8 9
10 11 12 13 14 15 16
17 18 19 20 21 22 23
24 25 26 27 28 29 30
31

```

```

\tikz \calendar[dates=2000-01-01 to 2000-02-last,week list,
month label above centered];

```

```

February
1 2 3 4 5 6
7 8 9 10 11 12 13
14 15 16 17 18 19 20
21 22 23 24 25 26 27
28 29

```

The following options change the appearance of the month and year label:

`/tikz/month code=<code>` (no default, initially see below)

This option allows you to specify what the macro `\tikzmonthcode` should expand to.

By default, the `\tikzmonthcode` it is set to

```

\node[every month]{\tikzmonthtext};

```

Note that this node is not named by default.

`/tikz/month text=<text>` (no default)

This option allows you to change the macro `\tikzmonthtext`. By default, the month text is a long textual presentation of the current month being typeset.

```

January 2000
1 2
3 4 5 6 7 8 9
10 11 12 13 14 15 16
17 18 19 20 21 22 23
24 25 26 27 28 29 30
31

```

```

\tikz \calendar[dates=2000-01-01 to 2000-01-31,week list,
month label above centered,
month text=\textcolor{red}{\%mt} \%y-];

```

`/tikz/every month` (style, initially empty)

This style can be used to change the appearance of month labels.

`/tikz/year code=<code>` (no default)

Works like `month code`, only for years.

`/tikz/year text=<text>` (no default)

Works like `month text`, only for years.

`/tikz/every year` (no value)

Works like `every month`, only for years.

**Date ifs.** Much of the power of the `\calendar` command comes from the use of conditionals. There are two equivalent way of specifying such a conditional. First, you can add the text `if (<conditions>) <code or options>` to your `<calendar specification>`, possibly followed by `else<else code or options>`. You can have multiple such conditionals (but you cannot nest them in this simple manner). The second way is to use the following option:

`/tikz/if=<conditions><code or options>else<else code or options>` (no default)

This option has the same effect as giving a corresponding `if` in the `<calendar specification>`. The option is mostly useful for use in the `every calendar` style, where you cannot provide `if` conditionals otherwise.

Now, regardless of how you specify a conditional, it has the following effect (individually and independently for each date in the calendar):

1. It is checked whether the current date is one of the possibilities listed in `<conditions>`. An example of such a condition is `Sunday`. Thus, when you write `if (Saturday,Sunday) {foo}`, then `foo` will be executed for every day in the calendar that is a Saturday *or* a Sunday.

The command `\ifdate` and, thereby, `\pgfcalendarifdate` are used to evaluate the `<conditions>`, see page 506 for a complete list of possible tests. The most useful tests are: Tests like `Monday` and so on, `workday` for the days Monday to Friday, `weekend` for Saturday and Sunday, `equals` for testing whether the current date equals a given date, `at least` and `at least` for comparing the current date with a given date.

2. If the date passes the check, the `<code or options>` is evaluated in a manner to be described in a moment; if the date fails, the `<else code or options>` is evaluated, if present.

The `<code or options>` can either be some code. This is indicated by surrounding the code with curly braces. It can also be a list of TikZ options. This is indicated by surrounding the options with square brackets. For example in the date test `if (Sunday) {\draw...} else {\fill...}` there are two pieces of code involved. By comparison, `if (Sunday) [red] else [green]` involves two options.

If `<code or options>` is code, it is simply executed (for the current day). If it is a list of options, these options are passed to a scope surrounding the current date.

Let us now have a look at some examples. First, we use a conditional to make all Sundays red.

```
      1  2
  3  4  5  6  7  8  9
10 11 12 13 14 15 16
17 18 19 20 21 22 23
24 25 26 27 28 29 30
31
```

```
\tikz
\calendar
[dates=2000-01-01 to 2000-01-31,week list]
if (Sunday) [red];
```

Next, let us do something on a specific date:

```
      1  2
  3  4  5  6  7  8  9
10 11 12 13 14 15 16
17 18 19 20 21 22 23
24 25 26 27 28 29 30
31
```

```
\tikz
\calendar
[dates=2000-01-01 to 2000-01-31,week list]
if (Sunday) [red]
if (equals=2000-01-20) {\draw (0,0) circle (8pt)};
```

You might wonder why the circle seems to be “off” the date. Actually, it is centered on the date, it is just that the date label uses the `base east` anchor, which shifts the label up and right. To overcome this problem we can change the anchor:

```

1 2
3 4 5 6 7 8 9
10 11 12 13 14 15 16
17 18 19 (20) 21 22 23
24 25 26 27 28 29 30
31

```

```

\tikz [every day/.style={anchor=mid}]
\calendar
[dates=2000-01-01 to 2000-01-31,week list]
if (Sunday) [red]
if (equals=2000-01-20) {\draw (0,0) circle (8pt)};

```

However, the single day dates are now no longer aligned correctly. For this, we can change the day text to `\%d=`, which adds a space at the beginning of single day text.

In the following, more technical information is covered. Most readers may wish to skip it.

**The current date code.** As mentioned earlier, for each date in the calendar the current date code is executed. It is the job of this code to shift around date nodes, to render the date nodes, to draw the month labels and to do all other stuff that is necessary to draw a calendar.

The current date code consists of the following parts, in this order:

1. The before-scope code.
2. A scope is opened.
3. The at-begin-scope code.
4. All date-ifs from the *calendar specification* are executed.
5. The at-end-scope code.
6. The scope is closed.
7. The after-scope code.

All of the codes mentioned above can be changed using appropriate options, see below. In case you wonder why so many are needed, the reason is that the current date code as a whole is not surrounded by a scope or  $\TeX$  group. This means that code executed in the before-scope code and in the after-scope code has an effect on all following days. For example, if the after-scope code modifies the transformation matrix by shifting everything downward, all following days will be shifted downward. If each day does this, you get a list of days, one below the other.

However, you do not always want code to have an effect on everything that follows. For instance, if a day has the date-if `if (Sunday) [red]`, we only want this Sunday to red, not all following days also. Similarly, sometimes it is easier to compute the position of a day relative to a fixed origin and we do not want any modifications of the transformation matrix to have an effect outside the scope.

By cleverly adjusting the different codes, all sorts of different day arrangements are possible.

`/tikz/execute before day scope=code` (no default)

The *code* is executed before everything else for each date. Multiple calls of this option have an accumulative effect. Thus, if you use this option twice, the code from the first use is used first for each day, followed by the code given the second time.

`/tikz/execute at begin day scope=code` (no default)

This code is executed before everything else inside the scope of the current date. Again, the effect is accumulative.

`/tikz/execute at end day scope=code` (no default)

This code is executed just before the day scope is closed. The effect is also accumulative, however, in reverse order. This is useful to pair, say, `\scope` and `\endscope` commands in at-begin- and at-end-code.

`/tikz/execute after day scope=code` (no default)

This is executed at the very end of the current date, outside the scope. The accumulation is also in reverse.

In the rest of the following subsections we have a look at how the different scope codes can be used to create different calendar arrangements.

### 26.1.1 Creating a Simple List of Days

We start with a list the days of the calendar, one day below the other. For this, we simply shift the coordinate system downward at the end of the code for each day. This shift must be *outside* the day scope as we want day shifts to accumulate. Thus, we use the following code:

```
1 \tikz
2   \calendar [dates=2000-01-01 to 2000-01-08,
3             execute after day scope=
4             {\pgftransformyshift{-1em}}];
5
6
7
8
```

Clearly, we can use this approach to create day lists going up, down, right, left, or even diagonally.

### 26.1.2 Adding a Month Label

We now want to add a month label to the left of the beginning of each month. The idea is to do two things:

1. We add code that is executed only on the first of each month.
2. The code is executed before the actual day is rendered. This ensures that options applying to the days do not affect the month rendering.

We have two options where we should add the month code: Either we add it at the beginning of the day scope or before. Either will work fine, but it might be safer to put the code inside the scope to ensure that settings to not inadvertently “leak outside.”

```
January 1 \tikz
2   \calendar
3   [dates=2000-01-01 to 2000-01-08,
4   execute after day scope={\pgftransformyshift{-1em}},
5   execute at begin day scope=
6   {\ifdate{day of month=1}{\tikzmonthcode}{}},
7   every month/.append style={anchor=base east,xshift=-2em}];
8
```

In the above code we used the `\ifdate{<condition>}{<then code>}{<else code>}` command, which is described on page 508 in detail and which has much the same effect as `if (<condition>){<then code>} else {<else code>}`, but works in normal code.

### 26.1.3 Creating a Week List Arrangement

Let us now address a more complicated arrangement: A week list. In this arrangement there is line for each week. The horizontal placement of the days is thus that all Mondays lie below each other, likewise for all Tuesdays, and so on.

In order to typeset this arrangement, we can use the following approach: The origin of the coordinate system rests at the anchor for the Monday of each week. That means that at the end of each week the origin is moved downward one line. On all other days, the origin at the end of the day code is the same as at the beginning. To position each day correctly, we use code inside and at the beginning of the day scope to horizontally shift the day according to its day of week.

```
1 2 \tikz
3 4 5 6 7 8 9 \calendar
10111213141516 [dates=2000-01-01 to 2000-01-20,
17181920 % each day is shifted right according to the day of week
execute at begin day scope=
{\pgftransformxshift{\pgfcalendarcurrentweekday em}},
% after each week, the origin is shifted downward:
execute after day scope=
{\ifdate{Sunday}{\pgftransformyshift{-1em}}{}}];
```

### 26.1.4 Creating a Month List Arrangement

For another example, let us create an arrangement that contains one line for each month. This is easy enough to do as for weeks, unless we add the following requirement: Again, we want all days in a column to have the same day of week. Since months start on different days of week, this means that each row has to have an individual offset.

One possible way is to use the following approach: After each month (or at the beginning of each month) we advance the vertical position of the offset by one line. For horizontal placement, inside the day scope we locally shift the day by its day of month. Furthermore, we must additionally shift the day to ensure that the first day of the month lies on the correct day of week column. For this, we remember this day of week the first time we see it.

```

1 2 3 4 5 6 7 8 910111213141516171819202122232425262728293031
1 2 3 4 5 6 7 8 91011121314151617181920212223242526272829

```

```

\newcount\mycount
\tikz
\calendar
[dates=2000-01-01 to 2000-02-last,
execute before day scope=
{
\ifdate{day of month=1} {
% Remember the weekday of first day of month
\mycount=\pgfcalendarcurrentweekday
% Shift downward
\pgftransformyshift{-1em}
}{}
},
execute at begin day scope=
{
% each day is shifted right according to the day of month
\pgftransformxshift{\pgfcalendarcurrentday em}
% and additionally according to the weekday of the first
\pgftransformxshift{\the\mycount em}
}];

```

## 26.2 Arrangements

An *arrangement* specifies how the days of calendar are arranged on the page. The calendar library defines a number of predefined arrangements.

We start with arrangements in which the days are listed in a long line.

`/tikz/day list downward` (style, no value)

This style causes the days of a month to be typeset one below the other. The shift between days is given by `day yshift`. Between month an additional shift of `month yshift` is added.

```

28
29
30
31
1
2
3

```

```

\tikz
\calendar [dates=2000-01-28 to 2000-02-03,
day list downward,month yshift=1em];

```

`/tikz/day list upward` (style, no value)

works as above, only the list grows upward instead of downward.

```

3
2
1
31
30
29
28

```

```

\tikz
\calendar [dates=2000-01-28 to 2000-02-03,
day list upward,month yshift=1em];

```

`/tikz/day list right` (style, no value)

This style also works as before, but the list of days grows to the right. Instead of `day yshift` and `month yshift`, the values of `day xshift` and `month xshift` are used.

```

28 29 30 31 1 2 3

```

```

\tikz
\calendar [dates=2000-01-28 to 2000-02-03,
day list right,month xshift=1em];

```

`/tikz/day list left` (style, no value)

As above, but the list grows left.

The next arrangement lists days weekwise.

`/tikz/week list` (style, no value)

This style creates one row for each week in the range. The value of `day xshift` is used for the distance between days in each week row, the value of `day yshift` is used for the distance between rows. In both cases, “distance” refers to the distance between the anchors of the nodes of the days (or, more generally, the distance between the origins of the little pictures created for each day).

The days inside each week are shifted such that Monday is always at the first position (to change this, you need to copy and then modify the code appropriately). If the date range does not start on a Monday, the first line will not start in the first column, but rather in the column appropriate for the first date in the range.

At the beginning of each month (except for the first month in the range) an additional vertical space of `month yshift` is added. If this is set to `0pt` you get a continuous list of days.

```

1 2
3 4 5 6 7 8 9
10 11 12 13 14 15 16
17 18 19 20 21 22 23
24 25 26 27 28 29 30
31

1 2 3 4 5 6
7 8 9 10 11 12 13
14 15 16 17 18 19 20
21 22 23 24 25 26 27
28 29

```

```

\tikz
\calendar [dates=2000-01-01 to 2000-02-last,week list];

```



```

          1 2
    3 4 5 6 7 8 9
  10 11 12 13 14 15 16
  17 18 19 20 21 22 23
  24 25 26 27 28 29 30
  31 1 2 3 4 5 6
    7 8 9 10 11 12 13
  14 15 16 17 18 19 20
  21 22 23 24 25 26 27
  28 29

```

```

\tikz
\calendar [dates=2000-01-01 to 2000-02-last,week list,
month yshift=0pt];

```

The following arrangement gives a very compact view of a whole year.

`/tikz/month list` (style, no value)

In this arrangement there is a row for each month. As for the `week list`, the `day xshift` is used for the horizontal distance. For the vertical shift, `month yshift` is used.

In each row, all days of the month are listed alongside each other. However, it is once more ensured that days in each column lie on the same day of week. Thus, the very first column contains only Mondays. If a month does not start with a Monday, its days are shifted to the right such that the days lie on the correct columns.

|           |   |   |   |   |   |   |   |   |   |    |    |    |    |    |    |    |    |    |    |    |    |    |    |    |    |    |    |    |    |    |    |    |    |    |    |  |  |
|-----------|---|---|---|---|---|---|---|---|---|----|----|----|----|----|----|----|----|----|----|----|----|----|----|----|----|----|----|----|----|----|----|----|----|----|----|--|--|
| January   |   |   |   |   | 1 | 2 | 3 | 4 | 5 | 6  | 7  | 8  | 9  | 10 | 11 | 12 | 13 | 14 | 15 | 16 | 17 | 18 | 19 | 20 | 21 | 22 | 23 | 24 | 25 | 26 | 27 | 28 | 29 | 30 | 31 |  |  |
| February  | 1 | 2 | 3 | 4 | 5 | 6 | 7 | 8 | 9 | 10 | 11 | 12 | 13 | 14 | 15 | 16 | 17 | 18 | 19 | 20 | 21 | 22 | 23 | 24 | 25 | 26 | 27 | 28 | 29 |    |    |    |    |    |    |  |  |
| March     |   | 1 | 2 | 3 | 4 | 5 | 6 | 7 | 8 | 9  | 10 | 11 | 12 | 13 | 14 | 15 | 16 | 17 | 18 | 19 | 20 | 21 | 22 | 23 | 24 | 25 | 26 | 27 | 28 | 29 | 30 | 31 |    |    |    |  |  |
| April     |   |   |   | 1 | 2 | 3 | 4 | 5 | 6 | 7  | 8  | 9  | 10 | 11 | 12 | 13 | 14 | 15 | 16 | 17 | 18 | 19 | 20 | 21 | 22 | 23 | 24 | 25 | 26 | 27 | 28 | 29 | 30 |    |    |  |  |
| May       | 1 | 2 | 3 | 4 | 5 | 6 | 7 | 8 | 9 | 10 | 11 | 12 | 13 | 14 | 15 | 16 | 17 | 18 | 19 | 20 | 21 | 22 | 23 | 24 | 25 | 26 | 27 | 28 | 29 | 30 | 31 |    |    |    |    |  |  |
| June      |   | 1 | 2 | 3 | 4 | 5 | 6 | 7 | 8 | 9  | 10 | 11 | 12 | 13 | 14 | 15 | 16 | 17 | 18 | 19 | 20 | 21 | 22 | 23 | 24 | 25 | 26 | 27 | 28 | 29 | 30 |    |    |    |    |  |  |
| July      |   |   | 1 | 2 | 3 | 4 | 5 | 6 | 7 | 8  | 9  | 10 | 11 | 12 | 13 | 14 | 15 | 16 | 17 | 18 | 19 | 20 | 21 | 22 | 23 | 24 | 25 | 26 | 27 | 28 | 29 | 30 | 31 |    |    |  |  |
| August    | 1 | 2 | 3 | 4 | 5 | 6 | 7 | 8 | 9 | 10 | 11 | 12 | 13 | 14 | 15 | 16 | 17 | 18 | 19 | 20 | 21 | 22 | 23 | 24 | 25 | 26 | 27 | 28 | 29 | 30 | 31 |    |    |    |    |  |  |
| September |   |   | 1 | 2 | 3 | 4 | 5 | 6 | 7 | 8  | 9  | 10 | 11 | 12 | 13 | 14 | 15 | 16 | 17 | 18 | 19 | 20 | 21 | 22 | 23 | 24 | 25 | 26 | 27 | 28 | 29 | 30 |    |    |    |  |  |
| October   |   |   |   | 1 | 2 | 3 | 4 | 5 | 6 | 7  | 8  | 9  | 10 | 11 | 12 | 13 | 14 | 15 | 16 | 17 | 18 | 19 | 20 | 21 | 22 | 23 | 24 | 25 | 26 | 27 | 28 | 29 | 30 | 31 |    |  |  |
| November  | 1 | 2 | 3 | 4 | 5 | 6 | 7 | 8 | 9 | 10 | 11 | 12 | 13 | 14 | 15 | 16 | 17 | 18 | 19 | 20 | 21 | 22 | 23 | 24 | 25 | 26 | 27 | 28 | 29 | 30 |    |    |    |    |    |  |  |
| December  |   |   | 1 | 2 | 3 | 4 | 5 | 6 | 7 | 8  | 9  | 10 | 11 | 12 | 13 | 14 | 15 | 16 | 17 | 18 | 19 | 20 | 21 | 22 | 23 | 24 | 25 | 26 | 27 | 28 | 29 | 30 | 31 |    |    |  |  |

```

\sfamily\scriptsize
\tikz
\calendar [dates=2000-01-01 to 2000-12-31,
month list,month label left,month yshift=1.25em]
if (Sunday) [black!50];

```

### 26.3 Month Labels

For many calendars you may wish to add a labels to each month. We have already covered how month nodes are created and rendered in the description of the `\calendar` command: use `month text`, `every month`, and also `month code` (if necessary) to change the appearance of the month labels.

What we have not yet covered is where these labels are placed. By default, they are not placed at all as there is no good “default position” for them. Instead, you can use one of the following options to specify a position for the labels:

`/tikz/month label left` (style, no value)

Places the month label to the left of the first day of the month. (For `week list` and `month list` where a month does not start on a Monday, the position is chosen “as if” the month had started on a Monday – which is usually exactly what you want.)

|            |                                                                                                                                                                      |
|------------|----------------------------------------------------------------------------------------------------------------------------------------------------------------------|
| 28         | <code>\tikz</code><br><code>\calendar [dates=2000-01-28 to 2000-02-03,</code><br><code>day list downward,month yshift=1em,</code><br><code>month label left];</code> |
| 29         |                                                                                                                                                                      |
| 30         |                                                                                                                                                                      |
| 31         |                                                                                                                                                                      |
| February 1 |                                                                                                                                                                      |
|            | 2                                                                                                                                                                    |
|            | 3                                                                                                                                                                    |

`/tikz/month label left vertical` (style, no value)

This style works like the above style, only the label is rotated counterclockwise by 90 degrees.

|            |                                                                                                                                                                               |
|------------|-------------------------------------------------------------------------------------------------------------------------------------------------------------------------------|
| 28         | <code>\tikz</code><br><code>\calendar [dates=2000-01-28 to 2000-02-03,</code><br><code>day list downward,month yshift=1em,</code><br><code>month label left vertical];</code> |
| 29         |                                                                                                                                                                               |
| 30         |                                                                                                                                                                               |
| 31         |                                                                                                                                                                               |
| February 1 |                                                                                                                                                                               |
|            | 2                                                                                                                                                                             |
|            | 3                                                                                                                                                                             |

`/tikz/month label right` (style, no value)

This style places the month label to the right of the row in which the first day of the month lies. This means that for a day list the label is to the right of the first day, for a week list it is to the right of the first week, and for a month list it is to the right of the whole month.

|            |                                                                                                                                                                       |
|------------|-----------------------------------------------------------------------------------------------------------------------------------------------------------------------|
| 28         | <code>\tikz</code><br><code>\calendar [dates=2000-01-28 to 2000-02-03,</code><br><code>day list downward,month yshift=1em,</code><br><code>month label right];</code> |
| 29         |                                                                                                                                                                       |
| 30         |                                                                                                                                                                       |
| 31         |                                                                                                                                                                       |
| 1 February |                                                                                                                                                                       |
|            | 2                                                                                                                                                                     |
|            | 3                                                                                                                                                                     |

`/tikz/month label right vertical` (style, no value)

Works as above, only the label is rotated clockwise by 90 degrees.

|            |                                                                                                                                                                                |
|------------|--------------------------------------------------------------------------------------------------------------------------------------------------------------------------------|
| 28         | <code>\tikz</code><br><code>\calendar [dates=2000-01-28 to 2000-02-03,</code><br><code>day list downward,month yshift=1em,</code><br><code>month label right vertical];</code> |
| 29         |                                                                                                                                                                                |
| 30         |                                                                                                                                                                                |
| 31         |                                                                                                                                                                                |
| 1 February |                                                                                                                                                                                |
|            | 2                                                                                                                                                                              |
|            | 3                                                                                                                                                                              |

`/tikz/month label above left` (style, no value)

This style places the month label above of the row of the first day, flushed left to the leftmost column. The amount by which the label is raised is fixed to 1.25em; use the `yshift` option with the month node to modify this.

```

                February
28 29 30 31    1  2  3

```

```

\tikz
\calendar [dates=2000-01-28 to 2000-02-03,
           day list right,month xshift=1em,
           month label above left];

```

```

                20 21 22 23
24 25 26 27 28 29 30
31

```

```

\tikz
\calendar [dates=2000-01-20 to 2000-02-10,
           week list,month label above left];

```

```

February
  1  2  3  4  5  6
  7  8  9 10

```

**/tikz/month label above centered**

(style, no value)

works as above, only the label is centered above the row containing the first day.

```

                February
  1  2  3  4  5  6  7  8  9 10 11 12 13 14 15 16 17 18 19 20 21 22 23 24 25 26 27 28 29

```

```

\tikz
\calendar [dates=2000-02-01 to 2000-02-last,
           day list right,month label above centered];

```

```

                20 21 22 23
24 25 26 27 28 29 30
31

```

```

\tikz
\calendar [dates=2000-01-20 to 2000-02-10,
           week list,month label above centered];

```

```

                February
  1  2  3  4  5  6
  7  8  9 10

```

**/tikz/month label above right**

(style, no value)

works as above, but flushed right

```

                20 21 22 23
24 25 26 27 28 29 30
31

```

```

\tikz
\calendar [dates=2000-01-20 to 2000-02-10,
           week list,month label above right];

```

```

                February
  1  2  3  4  5  6
  7  8  9 10

```

**/tikz/month label below left**

(style, no value)

Works like `month label above left`, only the label is placed below the row. This placement is not really useful with the `week list` arrangement, but rather with the `day list right` or `month list` arrangement.

```

  1  2  3  4  5  6  7  8  9 10 11 12 13 14 15 16 17 18 19 20 21 22 23 24 25 26 27 28 29
February

```

```
\tikz
\calendar [dates=2000-02-01 to 2000-02-last,
day list right,month label below left];
```

`/tikz/month label below centered`

(style, no value)

Works like month label above centered, only below.

```
1 2 3 4 5 6 7 8 9 10 11 12 13 14 15 16 17 18 19 20 21 22 23 24 25 26 27 28 29
February
```

```
\tikz
\calendar [dates=2000-02-01 to 2000-02-last,
day list right,month label below centered];
```

## 26.4 Examples

In the following, some example calendars are shown that come either from real applications or are just nice to look at.

Let us start with a year-2100-countdown, in which we cross out dates as we approach the big celebration. For this, we set the shape to `strike out` for these dates.

```
December 2099
  1 2 3 4 5 6
 7 8 9 10 11 12 13
14 15 16 17 18 19 20
21 22 23 24 25 26 27
28 29 30 31

January 2100
                1 2 3
4 5 6 7 8 9 10
11 12 13 14 15 16 17
18 19 20 21 22 23 24
25 26 27 28 29 30 31
```

```
\begin{tikzpicture}
\calendar
[
  dates=2099-12-01 to 2100-01-last,
  week list,inner sep=2pt,month label above centered,
  month text=\%mt \%y0
]
if (at most=2099-12-29) [nodes={strike out,draw}]
if (weekend) [black!50,nodes={draw=none}]
;
\end{tikzpicture}
```

The next calendar shows a deadline, which is 10 days in the future from the current date. The last three days before the deadline are in red, because we really should be done by then. All days on which we can no longer work on the project are crossed out.

```
                26 27 28 29
30 31

April 2009
  1 2 3 4 5
 6 7 8 9 10 11 12
13 14 15 16 17 18 19
20 21 22 23 24 25 26
27 28 29 30

May 2009
                1 2 3
4 5 6 7 8 9 10
11 12 13 14 15
```

```
\begin{tikzpicture}
\calendar
[
  dates=\year-\month-\day+-25 to \year-\month-\day+25,
  week list,inner sep=2pt,month label above centered,
  month text=\textit{\%mt \%y0}
]
if (at least=\year-\month-\day) {}
else [nodes={strike out,draw}]
if (at most=\year-\month-\day+7)
[green!50!black]
if (between=\year-\month-\day+8 and \year-\month-\day+10)
[red]
if (Sunday)
[gray,nodes={draw=none}]
;
\end{tikzpicture}
```

The following example is a futuristic calendar that is all about circles:

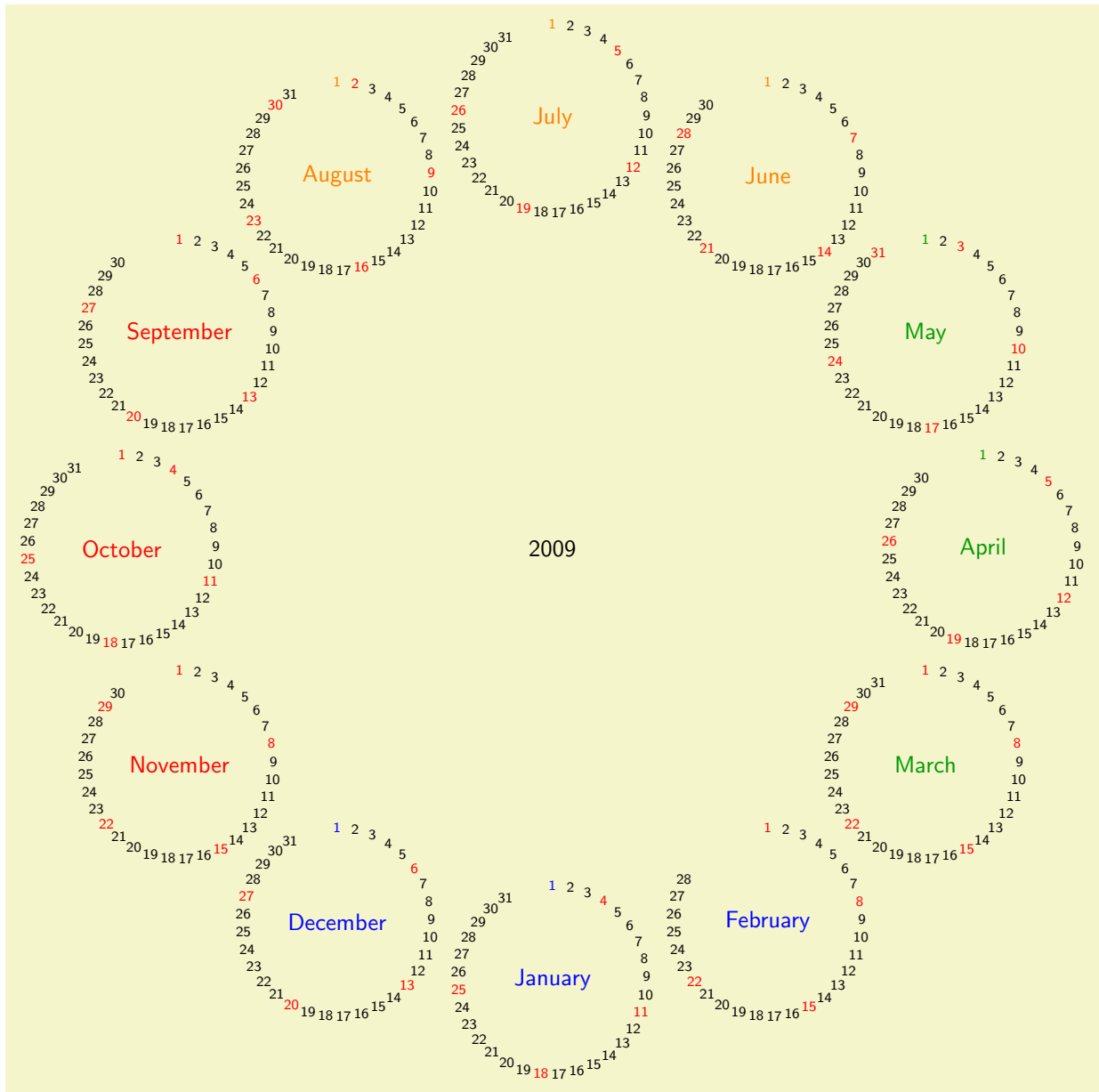

```

\sfamily

\colorlet{winter}{blue}
\colorlet{spring}{green!60!black}
\colorlet{summer}{orange}
\colorlet{fall}{red}

% A counter, since TikZ is not clever enough (yet) to handle
% arbitrary angle systems.
\newcount\mycount

\begin{tikzpicture}
  [transform shape,
  every day/.style={anchor=mid,font=\fontsize{6}{6}\selectfont}]
  \node{\normalsize\the\year};
  \foreach \month/\monthcolor in
    {1/winter,2/winter,3/spring,4/spring,5/spring,6/summer,
     7/summer,8/summer,9/fall,10/fall,11/fall,12/winter}
  {
    % Computer angle:
    \mycount=\month
    \advance\mycount by -1
    \multiply\mycount by 30
    \advance\mycount by -90

    % The actual calendar
    \calendar at (\the\mycount:6.4cm)
    [
      dates=\the\year-\month-01 to \the\year-\month-last,
    ]
    if (day of month=1) {\color{\monthcolor}\tikzmonthcode}
    if (Sunday) [red]
    if (all)
    {
      % Again, compute angle
      \mycount=1
      \advance\mycount by -\pgfcalendarcurrentday
      \multiply\mycount by 11
      \advance\mycount by 90
      \pgftransformshift{\pgfpointpolar{\mycount}{1.4cm}}
    };
  }
\end{tikzpicture}

```

Next, lets us have a whole year in a tight column:

```

01      1  2  3  4
      5  6  7  8  9 10 11
      12 13 14 15 16 17 18
      19 20 21 22 23 24 25
02 26 27 28 29 30 31  1
      2  3  4  5  6  7  8
      9 10 11 12 13 14 15
      16 17 18 19 20 21 22
03 23 24 25 26 27 28  1
      2  3  4  5  6  7  8
      9 10 11 12 13 14 15
      16 17 18 19 20 21 22
      23 24 25 26 27 28 29
04 30 31  1  2  3  4  5
      6  7  8  9 10 11 12
      13 14 15 16 17 18 19
      20 21 22 23 24 25 26
05 27 28 29 30  1  2  3
      4  5  6  7  8  9 10
      11 12 13 14 15 16 17
      18 19 20 21 22 23 24
      25 26 27 28 29 30 31
06  1  2  3  4  5  6  7
      8  9 10 11 12 13 14
      15 16 17 18 19 20 21
      22 23 24 25 26 27 28
07 29 30  1  2  3  4  5
      6  7  8  9 10 11 12
      13 14 15 16 17 18 19
      20 21 22 23 24 25 26
08 27 28 29 30 31  1  2
      3  4  5  6  7  8  9
      10 11 12 13 14 15 16
      17 18 19 20 21 22 23
      24 25 26 27 28 29 30
09 31  1  2  3  4  5  6
      7  8  9 10 11 12 13
      14 15 16 17 18 19 20
      21 22 23 24 25 26 27
10 28 29 30  1  2  3  4
      5  6  7  8  9 10 11
      12 13 14 15 16 17 18
      19 20 21 22 23 24 25
11 26 27 28 29 30 31  1
      2  3  4  5  6  7  8
      9 10 11 12 13 14 15
      16 17 18 19 20 21 22
      23 24 25 26 27 28 29
12 30  1  2  3  4  5  6
      7  8  9 10 11 12 13
      14 15 16 17 18 19 20
      21 22 23 24 25 26 27
      28 29 30 31

```

```

\begin{tikzpicture}
  \small\sffamily
  \colorlet{darkgreen}{green!50!black}
  \calendar[dates=\year-01-01 to \year-12-31,week list,
            month label left,month yshift=0pt,
            month text=\textcolor{darkgreen}{\%m0}]
            if (Sunday) [black!50];
\end{tikzpicture}

```

## 27 Chains

```
\usetikzlibrary{chains} %  $\TeX$  and plain  $\TeX$ 
\usetikzlibrary[chains] % Con $\TeX$ t
```

This library defines options for creating chains.

### 27.1 Overview

*Chains* are sequences of nodes that are – typically – arranged in an o row or a column and that are – typically – connected by edges. More generally, they can be used to position nodes of a branching network in a systematic manner. For the positioning of nodes in rows and columns you can also use matrices, see Section 17, but chains can also be used to describe the connections between nodes that have already been connected using, say, matrices. Thus, it often makes sense to use matrices for the positioning of elements and chains to describe the connections.

### 27.2 Starting and Continuing a Chain

Typically, you construct one chain at a time, but it is permissible to have construct multiple chains simultaneously. In this case, the chains must be named differently and you must specify for each node which chain it belongs to.

The first step toward creating a chain is to use the `start chain` option.

```
/tikz/start chain=<chain name><direction> (no default)
```

This key should, but need not, be given as an option to a scope enclosing all nodes of the chain. Typically, this will be a `scope` or the whole `tikzpicture`, but it might just be a path on which all nodes of the chain are found. If no *<chain name>* is given, the default value `chain` will be used instead.

The key starts a chain named *<chain name>* and makes it *active*, which means that is currently being constructed. The `start chain` can be issued only once to activate a chain, inside a scope in which a chain is active you cannot use this option once more (for the same chain name). The chain stops being active at the end of the scope in which the `start chain` command was given.

Although chains are only locally active (that is, active inside the scope the `start chain` command was issued), the information concerning the chains is stored globally and it is possible to *continue* a chain after a scope has ended. For this, the `continue chain` option can be used, which allows you to reactivate an existing chain in another scope.

The *<direction>* is used to determine the placement rule for nodes on the chain. If it is omitted, the current value of the following key is used:

```
/tikz/chain default direction=<direction> (no default, initially going right)
```

This *<direction>* is used in a `chain` option, if no other *<direction>* is specified.

The *<direction>* can have two different forms: `going <options>` or `placed <options>`. The effect of these rules will be explained in the description of the `on chain` option. Right now, just remember that the *<direction>* you provide with the `chain` option applies to the whole chain.

Other than this, this key has no further effect. In particular, to place nodes on the chain, you must use the `on chain` option, described next.

|                 |                                                                                                                                                                    |
|-----------------|--------------------------------------------------------------------------------------------------------------------------------------------------------------------|
| A      B      C | <pre>\begin{tikzpicture}[start chain] % The chain is called just "chain" \node [on chain] {A}; \node [on chain] {B}; \node [on chain] {C}; \end{tikzpicture}</pre> |
|-----------------|--------------------------------------------------------------------------------------------------------------------------------------------------------------------|

|                 |                                                                                                                                                                                 |
|-----------------|---------------------------------------------------------------------------------------------------------------------------------------------------------------------------------|
| A      B      C | <pre>\begin{tikzpicture} % Same as above, using the scope shorthand { [start chain] \node [on chain] {A}; \node [on chain] {B}; \node [on chain] {C}; } \end{tikzpicture}</pre> |
|-----------------|---------------------------------------------------------------------------------------------------------------------------------------------------------------------------------|



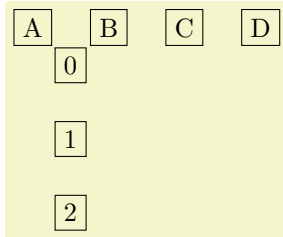

```
\begin{tikzpicture}[start chain=1 going right,
                    start chain=2 going below,
                    node distance=5mm,
                    every node/.style=draw]
  \node [on chain=1] {A};
  \node [on chain=1] {B};
  \node [on chain=1] {C};

  \node [on chain=2] at (0.5,-.5) {0};
  \node [on chain=2] {1};
  \node [on chain=2] {2};

  \node [on chain=1] {D};
\end{tikzpicture}
```

`/tikz/continue chain=<chain name><direction>` (no default)

This option allows you to (re)activate an existing chain and to possibly change the default direction. If the *chain name* is missing, the name of the innermost activated chain is used. If no chain is activated, *chain* is used.

Let us have a look at the two different applications of this option. The first is to change the direction of a chain as it is begin constructed. For this, just give this option somewhere inside the scope of the chain.

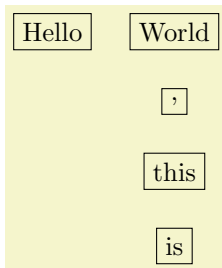

```
\begin{tikzpicture}[start chain=going right,node distance=5mm]
  \node [draw,on chain] {Hello};
  \node [draw,on chain] {World};
  \node [draw,continue chain=going below,on chain] {,};
  \node [draw,on chain] {this};
  \node [draw,on chain] {is};
\end{tikzpicture}
```

The second application is to reactivate a chain after it “has already been closed down.”

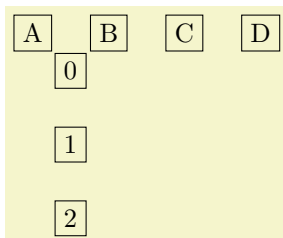

```
\begin{tikzpicture}[node distance=5mm,
                    every node/.style=draw]
  { [start chain=1]
    \node [on chain] {A};
    \node [on chain] {B};
    \node [on chain] {C};
  }

  { [start chain=2 going below]
    \node [on chain=2] at (0.5,-.5) {0};
    \node [on chain=2] {1};
    \node [on chain=2] {2};
  }

  { [continue chain=1]
    \node [on chain] {D};
  }
\end{tikzpicture}
```

### 27.3 Nodes on a Chain

`/tikz/on chain=<chain name><direction>` (no default)

This key should be given as an option to a node. When the option is used, the *<chain name>* must be the name of a chain that has been started using the `start chain` option. If *<chain name>* is the empty string, the current value of the innermost activated chain is used. If this option is used several times for a node, only the last invocation “wins.” (To place a node on several chains, use the `\chainin` command repeatedly.)

The *<direction>* part is optional. If present it sets the direction used for this node, otherwise the *<direction>* that was given to the original `start chain` option is used (or of the last `continue chain` option, which allows you to change this default).

The effects of this option are the following:

1. An internal counter (there is one, local, counter for each chain) is increased. This counter reflects the current number of the node in the chain, where the first node is node 1, the second is node 2, and so on.  
This value of this internal counter is globally stored in the macro `\tikzchaincount`.
2. If the node does not yet have a name, (having been given using the `name` option or the `name-syntax`), the name of the node is set to  $\langle chain\ name \rangle - \langle value\ of\ the\ internal\ chain\ counter \rangle$ . For instance, if the chain is called `nums`, the first node would be named `nums-1`, the second `nums-2`, and so on. For the default chain name `chain`, the first node is named `chain-1`, the second `chain-2`, and so on.
3. Independently of whether the name has been provided automatically or via the `name` option, the name of the node is globally stored in the macro `\tikzchaincurrent`.
4. Except for the first node, the macro `\tikzchainprevious` is now globally set to the name of the node of the previous node on the chain. For the first node of the chain, this macro is globally set to the empty string.
5. Except possibly for the first node of the chain, the placement rule is now executed. The placement rule is just a TikZ option that is applied automatically to each node on the chain. Depending on the form of the  $\langle direction \rangle$  parameter (either the locally given one or the one given to the `start chain` option), different things happen.

First, it makes a difference whether the  $\langle direction \rangle$  starts with `going` or with `placed`. The difference is that in the first case, the placement rule is not applied to the first node of the chain, while in the second case the placement rule is applied also to this first node. The idea is that a `going-direction` indicates that we are “going somewhere relative to the previous node” whereas a `placed` indicates that we are “placing nodes according to their number.”

Independently of which form is used, the  $\langle text \rangle$  inside  $\langle direction \rangle$  that follows `going` or `placed` (separated by a compulsory space) can have two different effects:

- (a) If it contains an equal sign, then this  $\langle text \rangle$  is used as the placement rule, that is, it is simply executed.
- (b) If it does not contain an equal sign, then  $\langle text \rangle = of\ \tikzchainprevious$  is used as the placement rule.

Note that in the first case, inside the  $\langle text \rangle$  you have access to `\tikzchainprevious` and `\tikzchaincount` for doing your positioning calculations.

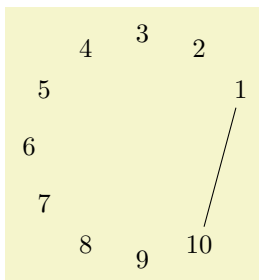

```
\begin{tikzpicture}[start chain=circle placed {at=(\tikzchaincount*30:1.5)}]
  \foreach \i in {1,...,10}
    \node [on chain] {\i};

  \draw (circle-1) -- (circle-10);
\end{tikzpicture}
```

6. The following style is executed:

`/tikz/every on chain`

(style, no value)

This key is executed for every node of a chain, including the first one.

Recall that the standard replacement rule has a form like `right=of (\tikzchainprevious)`. This means that each new node is placed to the right of the previous one, spaced by the current value of `node distance`.

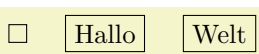

```
\begin{tikzpicture}[start chain,node distance=5mm]
  \node [draw,on chain] {};
  \node [draw,on chain] {Hallo};
  \node [draw,on chain] {Welt};
\end{tikzpicture}
```

The optional  $\langle direction \rangle$  allows us to temporarily change the direction in the middle of a chain:

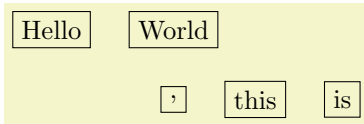

```
\begin{tikzpicture}[start chain,node distance=5mm]
  \node [draw,on chain] {Hello};
  \node [draw,on chain] {World};
  \node [draw,on chain=going below] {,};
  \node [draw,on chain] {this};
  \node [draw,on chain] {is};
\end{tikzpicture}
```

You can also use more complicated computations in the *direction*:

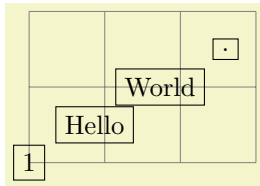

```
\begin{tikzpicture}[start chain=going {at=(\tikzchainprevious),shift=(30:1)}]
  \draw [help lines] (0,0) grid (3,2);
  \node [draw,on chain] {1};
  \node [draw,on chain] {Hello};
  \node [draw,on chain] {World};
  \node [draw,on chain] {.};
\end{tikzpicture}
```

For each chain, two special “pseudo nodes” are created.

Predefined node *<chain name>-begin*

This node is the same as the first node on the chain. It is only defined after a first node has been defined.

Predefined node *<chain name>-end*

This node is the same as the (currently) last node on the chain. As the chain is extended, this node changes.

The `on chain` option can also be used, in conjunction with `late options`, to add an already existing node to a chain. The following command, which is only defined inside scopes where a `start chain` option is present, simplifies this process.

`\chainin(<existing name>)` [*<options>*]

This command makes it easy to add a node to chain that has already been constructed. This node may even be part of a another chain.

When you say `\chainin (some node);`, the node `some node` must already exist. It will then be made part of the current chain. This does not mean that the node can be changed (it is already constructed, after all), but the `join` option can be used to join `some node` to the previous last node on the chain and subsequent nodes will be placed relative to `some node`.

It is permissible to give the `on chain` option inside the *<options>* in order to specify on which chain the node should be put.

This command is just a shortcut for

```
\path (<existing name>) [late options={on chain,every chain in,<options>}]
```

In particular, it is possible to continue to path after a `\chainin` command, though that does not seem very useful.

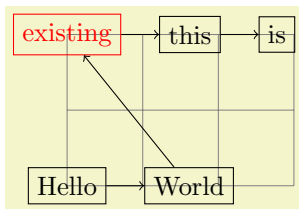

```
\begin{tikzpicture}[node distance=5mm,
  every node/.style=draw,every join/.style=->]
  \draw [help lines] (0,0) grid (3,2);
  \node[red] (existing) at (0,2) {existing};
  { [start chain]
    \node [draw,on chain,join] {Hello};
    \node [draw,on chain,join] {World};
    \chainin (existing) [join];
    \node [draw,on chain,join] {this};
    \node [draw,on chain,join] {is};
  }
\end{tikzpicture}
```

Here is an example where nodes are positioned using a matrix and then connected using a chain

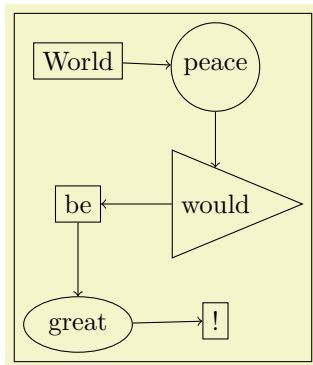

```
\begin{tikzpicture}[every node/.style=draw]
  \matrix [matrix of nodes,column sep=5mm,row sep=5mm]
  {
    |(a)|           World & |(b) [circle]|           peace \\
    |(c)|           be   & |(d) [isosceles triangle]| would \\
    |(e) [ellipse]| great & |(f)|                       ! \\
  };
  { [start chain,every on chain/.style={join=by ->}]
    \chainin (a);
    \chainin (b);
    \chainin (d);
    \chainin (c);
    \chainin (e);
    \chainin (f);
  }
\end{tikzpicture}
```

## 27.4 Joining Nodes on a Chain

`/tikz/join=with` *<with>* by *<options>* (no default)

When this key is given to any node on a chain (except possibly for the first node), an `edge` command is added after the node. The `with` part specifies which node should be used for the start point of the edge; if the `with` part is omitted, the `\tikzchainprevious` is used. This `edge` command gets the *<options>* as parameter and the current node as its target. If there is no previous node and no `with` is given, no `edge` command gets executed.

`/tikz/every join` (style, no value)

This style is executed each time this command is used.

Note that it makes sense to call this option several times for a node, in order to connect it to several nodes. This is especially useful for joining in branches, see the next section.

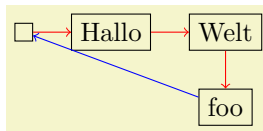

```
\begin{tikzpicture}[start chain,node distance=5mm,
  every join/.style={->,red}]
  \node [draw,on chain,join] {};
  \node [draw,on chain,join] {Hallo};
  \node [draw,on chain,join] {Welt};
  \node [draw,on chain=going below,
    join,join=with chain-1 by {blue,<-}] {foo};
\end{tikzpicture}
```

## 27.5 Branches

A *branch* is a chain that (typically only temporarily) extends an existing chain. The idea is the following: Suppose we are constructing a chain and at some node *x* there is a fork. In this case, one (or even more) branches starts at this fork. For each branch a chain is created, but the first node on this chain should be *x*. For this, it is useful to use `\chainin` on the node *x* to make it part of the different branch chains and to name the branch chains in some way that reflects the name of the main chain.

The `start branch` option provides a shorthand for doing exactly what was just described.

`/tikz/start branch=`*<branch name>**<direction>* (no default)

This key is used in the same manner as the `start chain` command, however, the effect is slightly different:

- This option may only be used if some chain is already active and there is a (last) node on this chain. Let us call this node the *<fork node>*.
- The chain is not just called *<branch name>*, but *<current chain>/<branch name>*. For instance, if the *<fork node>* is part of the chain called `trunk` and the *<branch name>* is set to `left`, the complete chain name of the branch is `trunk/left`. The *<branch name>* must be given, there is no default value.

- The *fork node* is automatically “chained into” the branch chain as its first node. Thus, for the first node on the branch that you provide, the `join` option will cause it to be connected to the fork node.

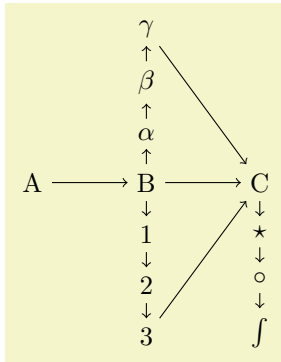

```
\begin{tikzpicture}[every on chain/.style=join, every join/.style=->,
                    node distance=2mm and 1cm]
{ [start chain=trunk]
  \node [on chain] {A};
  \node [on chain] {B};

  { [start branch=numbers going below]
    \node [on chain] {1};
    \node [on chain] {2};
    \node [on chain] {3};
  }

  { [start branch=greek going above]
    \node [on chain] {$\alpha$};
    \node [on chain] {$\beta$};
    \node [on chain] {$\gamma$};
  }

  \node [on chain, join=with trunk/numbers-end, join=with trunk/greek-end] {C};
  { [start branch=symbols going below]
    \node [on chain] {$\star$};
    \node [on chain] {$\circ$};
    \node [on chain] {$\int$};
  }
}
\end{tikzpicture}
```

`/tikz/continue branch=<branch name><direction>` (no default)

This option works like the `continue chain` option, only `<current chain>/<branch name>` is used as the chain name, rather than just `<branch name>`.

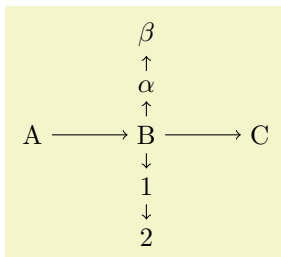

```
\begin{tikzpicture}[every on chain/.style=join, every join/.style=->,
                    node distance=2mm and 1cm]
{ [start chain=trunk]
  \node [on chain] {A};
  \node [on chain] {B};
  { [start branch=numbers going below] } % just a declaration,
  { [start branch=greek going above] } % we will come back later
  \node [on chain] {C};

  % Now come the branches...
  { [continue branch=numbers]
    \node [on chain] {1};
    \node [on chain] {2};
  }
  { [continue branch=greek]
    \node [on chain] {$\alpha$};
    \node [on chain] {$\beta$};
  }
}
\end{tikzpicture}
```

## 28 Circuit Libraries

Written and documented by Till Tantau, and Mark Wibrow. Inspired by the work of Massimo Redaelli.

### 28.1 Introduction

The circuit libraries can be used to draw different kinds of electrical or logical circuits. There is not a single library for this, but a whole hierarchy of libraries that work in concert. The main design goal was to create a balance between ease-of-use and ease-of-extending, while creating high-quality graphical representations of circuits.

#### 28.1.1 A First Example

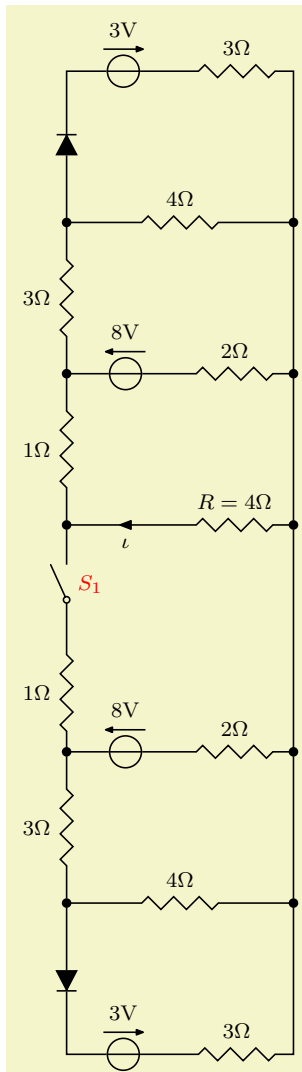

```
\begin{tikzpicture}[circuit ee IEC,x=3cm,y=2cm,semithick,
    every info/.style={font=\footnotesize},
    small circuit symbols,
    set resistor graphic=var resistor IEC graphic,
    set diode graphic=var diode IEC graphic,
    set make contact graphic= var make contact IEC graphic]
% Let us start with some contacts:
\foreach \contact/\y in {1/1,2/2,3/3.5,4/4.5,5/5.5}
{
  \node [contact] (left contact \contact) at (0,\y) {};
  \node [contact] (right contact \contact) at (1,\y) {};
}
\draw (right contact 1) -- (right contact 2) -- (right contact 3)
  -- (right contact 4) -- (right contact 5);

\draw (left contact 1) to [diode] ++(down:1)
  to [voltage source={near start,
    direction info={volt=3}},
    resistor={near end,ohm=3}] ++(right:1)
  to (right contact 1);
\draw (left contact 1) to [resistor={ohm=4}] (right contact 1);
\draw (left contact 1) to [resistor={ohm=3}] (left contact 2);
\draw (left contact 2) to [voltage source={near start,
    direction info={<,volt=8}},
    resistor={ohm=2,near end}] (right contact 2);
\draw (left contact 2) to [resistor={near start,ohm=1},
    make contact={near end,info'={[\red]$S_1$}}]
  (left contact 3);
\draw (left contact 3) to [current direction'={near start,info=$\iota$},
    resistor={near end,info={$R=4\Omega$}}]
  (right contact 3);
\draw (left contact 4) to [voltage source={near start,
    direction info={<,volt=8}},
    resistor={ohm=2,near end}] (right contact 4);
\draw (left contact 3) to [resistor={ohm=1}] (left contact 4);
\draw (left contact 4) to [resistor={ohm=3}] (left contact 5);
\draw (left contact 5) to [resistor={ohm=4}] (right contact 5);
\draw (left contact 5) to [diode] ++(up:1)
  to [voltage source={near start,
    direction info={volt=3}},
    resistor={near end,ohm=3}] ++(right:1)
  to (right contact 5);
\end{tikzpicture}
```

An important feature of the circuit library is that the appearance of a circuit can be configured in general ways and that the labels are placed automatically by default. Here is the graphic once more, generated from *exactly the same source code*, with only the options of the `{tikzpicture}` environment replaced by `[rotate=-90,circuit ee IEC,x=3.25cm,y=2.25cm]`:

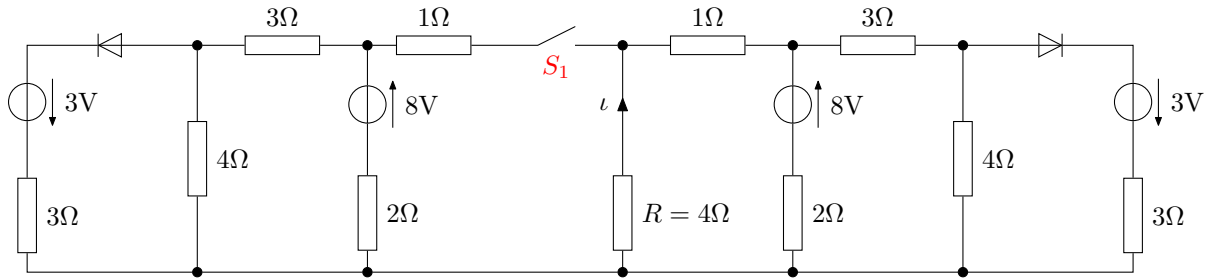

### 28.1.2 Symbols

A circuit typically consists of numerous electronic elements like logical gates or resistors or diodes that are connected by wires. In PGF/TikZ, we use nodes for the electronic elements and normal lines for the wires. TikZ offers a large number of different ways of positioning and connecting nodes in general, all of which can be used here. Additionally, the `circuits` library defines an additional useful `to-path` that is particularly useful for elements like a resistor on a line.

There are many different names that are used to refer to electrical “elements,” so a bit of terminology standardization is useful: We will call such elements *symbols*. A *symbol shape* is a PGF shape declared using the `\pgfdeclareshape` command. A *symbol node* is a node whose shape is a symbol shape.

### 28.1.3 Symbol Graphics

Symbols can be created by `\node[shape=some symbol shape]`. However, in order to represent some symbols correctly, just using standard PGF shapes is not sufficient. For instance, most symbols have a visually appealing “default size,” but the size of a symbol shape depends only on the current values of parameters like `minimum height` or `inner xsep`.

For these reasons, the circuit libraries introduce the concept of a *symbol graphic*. This is a style that causes a `\node` to not only have the correct shape, but also the correct size and the correct path usage. More generally, this style may setup things in any way so that the “symbol looks correct”. When you write, for instance, `\node[diode]`, then the style called `diode graphic` is used, which in turn is set to something like `shape=diode IEC,draw,minimum height=...`

Here is an overview of the different kinds of circuit libraries:

- The TikZ-library `circuits` defines general keys for creating circuits. Mostly, these keys are useful for defining more specialized libraries.

You normally do not use this library directly since it does not define any symbol graphics.

- The TikZ-library `circuits.logic` defines keys for creating logical gates like and-gates or xor-gates. However, this library also does not actually define any symbol graphics; this is done by two sublibraries:
  - The library `circuits.logic.US` defines symbol graphics that cause the logical gates to be rendered in the “US-style.” It includes all of the above libraries and you can use this library directly.
  - The library `circuits.logic.IEC` also defines symbol graphics for logical gates, but it uses rectangular gates rather than the round US-gates. This library can coexist peacefully with the above library, you can change which symbol graphics are used “on the fly.”
- The TikZ-library `circuits.ee` defines keys for symbols from electrical engineering like resistors or capacitors. Again, sublibraries define the actual symbol graphics.
  - The library `circuits.ee.IEC` defines symbol shapes that follow the IEC norm.
- The PGF-libraries `shapes.gates.*` define (circuit) symbol shapes. However, you normally do not use these shapes directly, rather you use a style that uses an appropriate symbol graphic, which in turn uses one of these shapes.

Let us have a look at a simple example. Suppose we wish to create a logical circuit. Then we first have to decide which symbol graphics we would like to use. Suppose we wish to use the US-style, then we would include the library `circuits.logic.US`. If you wish to use IEC-style symbols, use `circuits.logic.IEC`. If you cannot decide, include both:





`/tikz/circuits` (no value)

This key should be passed as an option to a picture or a scope that contains a circuit. It will do some internal setups. This key is normally called by more specialized keys like `circuit ee IEC`.

### 28.2.1 Symbol Size

`/tikz/circuit symbol unit=<dimension>` (no default, initially 7pt)

This dimension is a “unit” for the size of symbols. The libraries generally define the sizes of symbols relative to this dimension. For instance, the longer side of an inductor is, by default, in the IEC library equal to five times this  $\langle dimension \rangle$ . When you change this  $\langle dimension \rangle$ , the size of all symbols will automatically change accordingly.

Note, that it is still possible to overwrite the size of any particular symbol. These settings apply only to the default sizes.

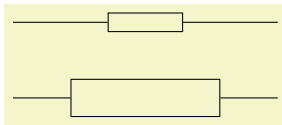

```
\begin{tikzpicture}[circuit ee IEC]
  \draw (0,1) to [resistor] (3.5,1);
  \draw[circuit symbol unit=14pt]
    (0,0) to [resistor] (3.5,0);
\end{tikzpicture}
```

`/tikz/huge circuit symbols` (style, no value)

This style sets the default circuit symbol unit to 10pt.

`/tikz/large circuit symbols` (style, no value)

This style sets the default circuit symbol unit to 8pt.

`/tikz/medium circuit symbols` (style, no value)

This style sets the default circuit symbol unit to 7pt.

`/tikz/small circuit symbols` (style, no value)

This style sets the default circuit symbol unit to 6pt.

`/tikz/tiny circuit symbols` (style, no value)

This style sets the default circuit symbol unit to 5pt.

`/tikz/circuit symbol size=width <width> height <height>` (no default)

This key sets minimum `height` to  $\langle height \rangle$  times the current value of the circuit symbol unit and the minimum `width` to  $\langle width \rangle$  times this value. Thus, this option can be used with a node command to set the size of the node as a multiple of the circuit symbol unit.

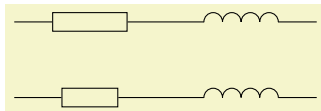

```
\begin{tikzpicture}[circuit ee IEC]
  \draw (0,1) to [resistor] (2,1) to[inductor] (4,1);

  \begin{scope}
    [every resistor/.style={circuit symbol size=width 3 height 1}]
    \draw (0,0) to [resistor] (2,0) to[inductor] (4,0);
  \end{scope}
\end{tikzpicture}
```

### 28.2.2 Declaring New Symbols

`/tikz/circuit declare symbol=<name>` (no default)

This key is used to declare a symbol. It does not cause this symbol to be shown nor does it set a graphic to be used for the symbol, it simply “prepares” several keys that can later be used to draw a symbol and to configure it.

In detail, the first key that is defined is just called  $\langle name \rangle$ . This key should be given as an option to a `node` or on a `to` path, as explained below. The key will take options, which can be used to influence the way the symbol graphic is rendered.

Let us have a look at an example. Suppose we want to define a symbol called `foo`, which just looks like a simple rectangle. We could then say

```
\tikzset{circuit declare symbol=foo}
```

The symbol could now be used like this:

```
\node [foo] at (1,1) {};  
\node [foo={red}] at (2,1) {};
```

However, in the above example we would not actually see anything since we have not yet setup the graphic to be used by `foo`. For this, we must use a key called `set foo graphic` or, generally, `set <name> graphic`. This key gets graphic options as parameter that will be set when a symbol `foo` should be shown:



```
\begin{tikzpicture}  
  [circuit declare symbol=foo,  
   set foo graphic={draw,shape=rectangle,minimum size=5mm}]  
  
  \node [foo] at (1,1) {};  
  \node [foo={red}] at (2,1) {};  
\end{tikzpicture}
```

In detail, when you use the key `<name>=<options>` with a node, the following happens:

1. The `inner sep` is set to 0.5pt.
2. The following style is executed:

```
/tikz/every circuit symbol (style, no value)
```

Use this style to setup things in general.

3. The graphic options that have been set using `set <name> graphic` are set.
4. The style `every <name>` is executed. You can use it to configure the symbol further.
5. The `<options>` are executed.

The key `<name>` will have a different effect when it is used on a `to` path command inside a `circuit` environment (the `circuit` environment sets up `to` paths in such a way that the use of a key declared using `circuit declare symbol` is automatically detected). When `<name>` is used on a `to` path, the above actions also happen (setting the inner separation, using the symbol graphic, and so on), but they are passed to the key `circuit handle symbol`, which is explained next.

```
/tikz/circuit handle symbol=<options> (no default)
```

This key is mostly used internally. Its purpose is to render a symbol. The effect of this key differs, depending on whether it is used as the optional argument of a `to` path command or elsewhere.

If the key is not used as an argument of a `to` path command, the `<options>` are simply executed.

The more interesting case happens when the key is given on a `to` path command. In this case, several things happen:

1. The `to` path is locally changed and set to an internal path (which you should not try to change) that consists mostly of a single straight line.
2. The `<options>` are tentatively executed with filtering switched on. Everything is filtered out, except for the key `pos` and also the styles `at start`, `very near start`, `near start`, `midway`, `near end`, `very near end`, and `at end`. If none of them is found, `midway` is used.
3. The filtered option is used to determine a position for the symbol on the path. At the given position (with `pos=0` representing the start and `pos=1` representing the end), a node will be added to the path (in a manner to be described presently).
4. This node gets `<options>` as its option list.
5. The node is added by virtue of a special `markings` decoration. This means that a `mark` command is executed that causes the node to be placed as a mark on the path.
6. The marking decoration will automatically subdivide the path and cause a line to be drawn to from the start of the path to the node's border (at the position that lies on a line from the node's center to the start of the path) and then from the node's border (at a position on the other side of the node) to the end of the path.

7. The marking decoration will also take care of the case that multiple marks are present on a path, in this case the lines from and to the borders of the nodes are only between consecutive nodes.
8. The marking decoration will also rotate the coordinate system in such a way that the  $x$ -axis points along the path. Thus, if you use the `transform shape` option, the node will “point along” the path.
9. In case a node is at `pos=0` or at `pos=1` some special code will suppress the superfluous lines to the start or end of the path.

The net effect of all of the above is that a node will be placed “on the path” and the path will have a “gap” just large enough to encompass the node. Another effect is that you can use this key multiple times on a path to add several nodes to a path, provided they do not overlap.

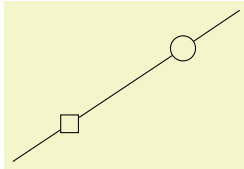

```
\begin{tikzpicture}[circuit]
\draw (0,0) to [circuit handle symbol={draw,shape=rectangle,near start},
               circuit handle symbol={draw,shape=circle,near end}] (3,2);
\end{tikzpicture}
```

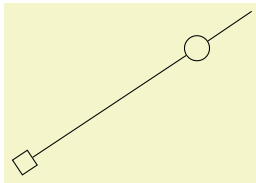

```
\begin{tikzpicture}[transform shape,circuit]
\draw (0,0) to [circuit handle symbol={draw,shape=rectangle,at start},
               circuit handle symbol={draw,shape=circle,near end}] (3,2);
\end{tikzpicture}
```

### 28.2.3 Pointing Symbols in the Right Direction

Unlike normal nodes, which generally should not be rotated since this will make their text hard to read, symbols often need to be rotated. There are two ways of achieving such rotations:

1. When you place a symbol on a `to` path, the graphic symbol is automatically rotated such that it “points along the path.” Here is an examples that show how the inductor shape (which looks, unrotated, like this: ) is automatically rotated around:

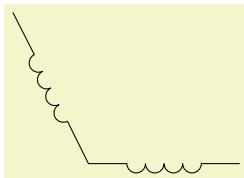

```
\tikz [circuit ee IEC]
\draw (3,0) to[inductor] (1,0) to[inductor] (0,2);
```

2. Many shapes cannot be placed “on” a path in this way, namely whenever there are more than two possible inputs. Also, you may wish to place the nodes first, possibly using a matrix, and connect them afterwards. In this case, you can simply add rotations like `rotate=90` to the shapes to rotate them. The following four keys make this slightly more convenient:

`/tikz/point up`

(no value)

This is the same as `rotate=90`.



```
\tikz [circuit ee IEC] \node [diode,point up] {};
```

`/tikz/point down`

(no value)

This is the same as `rotate=-90`.



```
\tikz [circuit ee IEC] \node [diode,point down] {};
```

`/tikz/point left` (no value)

This is the same as `rotate=-180`.

```
\tikz [circuit ee IEC] \node [diode,point left] {};
```

`/tikz/point right` (no value)

This key has no effect.

```
\tikz [circuit ee IEC] \node [diode,point right] {};
```

## 28.2.4 Info Labels

Info labels are used to add text to a circuit symbol. Unlike normal nodes like a rectangle, circuit symbols typically do not have text “on” them, but the text is placed next to them (like the text “ $3\Omega$ ” next to a resistor).

TikZ already provides the `label` option for this purpose. The `info` option is build on top of this option, but it comes in some predefined variants that are especially useful in conjunction with circuits.

`/tikz/info=[<options>]<angle>:<text>` (no default)

This key has nearly the same effect as the `label` key, only the following style is used additionally automatically:

`/tikz/every info` (style, no value)

Set this style to configure the styling of info labels. Since this key is *not* used with normal labels, it provides an easy way of changing the way info labels look without changing other labels.

The *<options>* and *<angle>* are passed directly to the `label` command.

```
3\Omega
\begin{tikzpicture}[circuit ee IEC,every info/.style=red]
  \node [resistor,info=$3\Omega$] {};
\end{tikzpicture}
```

You will find a detailed discussion of the `label` option on page 191.

Hint: To place some text *on* the main node, use `center` as the *<angle>*:

```
3\Omega R_1
\begin{tikzpicture}[circuit ee IEC,every info/.style=red]
  \node [resistor,info=center:$3\Omega$] {};
  \node [resistor,point up,info=center:$R_1$] at (2,0) {};
\end{tikzpicture}
```

`/tikz/info'=[<options>]<angle>:<text>` (no default)

This key works exactly like the `info` key, only in case the *<angle>* is missing, it defaults to `below` instead of the current value of `label position`, which is usually `above`. This means that when you use `info`, you get a label above the node, while when you use the `info'` key you get a label below the node. In case the node has been rotated, the positions of the info nodes are rotated accordingly.

```
4\Omega R_2
3\Omega R_1
\begin{tikzpicture}[circuit ee IEC,every info/.style=red]
  \draw (0,0) to[resistor={info={$3\Omega$},info'={$R_1$}}] (3,0)
    to[resistor={info={$4\Omega$},info'={$R_2$}}] (3,2);
\end{tikzpicture}
```

`/tikz/info sloped=[<options>]<angle>:<text>` (no default)

This key works like `info`, only the `transform shape` option is set when the label is drawn, causing it to follow the sloping of the main node.

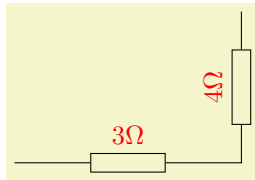

```
\begin{tikzpicture}[circuit ee IEC, every info/.style=red]
  \draw (0,0) to[resistor={info sloped={3\Omega}}] (3,0)
    to[resistor={info sloped={4\Omega}}] (3,2);
\end{tikzpicture}
```

`/tikz/info' sloped=` (no default)

This is a combination of `info'` and `info sloped`.

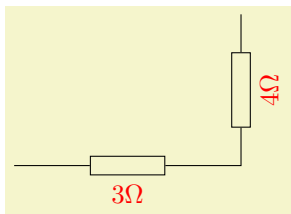

```
\begin{tikzpicture}[circuit ee IEC, every info/.style=red]
  \draw (0,0) to[resistor={info' sloped={3\Omega}}] (3,0)
    to[resistor={info' sloped={4\Omega}}] (3,2);
\end{tikzpicture}
```

`/tikz/circuit declare unit={<name>}{<unit>}` (no default)

This key is used to declare keys that make it easy to attach physical units to nodes. The idea is that instead of `info={3\Omega}` you can write `ohm=3` or instead of `info'={5\mathrm{S}}` you can write `siemens'=5`.

In detail, four keys are defined, namely `/tikz/<name>`, `/tikz/<name>'`, `/tikz/<name> sloped`, and `/tikz/<name>' sloped`. The arguments of all of these keys are of the form `[<options>]<angle>:<value>` and it is passed (slightly modified) to the corresponding key `info`, `info'`, `info sloped`, or `info' sloped`. The “slight modification” is the following: The text that is passed to the, say, `info` key is not `<value>`, but rather `\mathrm{<value><unit>}`

This means that after you said `circuit declare unit={ohm}{\Omega}`, then `ohm=5k` will have the same effect as `info={<every ohm>\mathrm{5k\Omega}}`. Here, `every ohm` is a style that allows you to configure the appearance of this unit. Since the `info` key is used internally, by changing the `every info` style, you can change the appearance of all units infos.

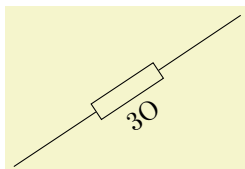

```
\begin{tikzpicture}[circuit ee IEC, circuit declare unit={my ohm}{0}]
  \draw (0,0) to[resistor={my ohm' sloped=3}] (3,2);
\end{tikzpicture}
```

### 28.2.5 Declaring and Using Annotations

Annotations are quite similar to info labels. The main difference is that they generally cause something to be drawn by default rather than some text to be added (although an annotation might also add some text).

Annotations can be declared using the following key:

`/tikz/circuit declare annotation={<name>}{<distance>}{<path>}` (no default)

This key is used to declare an annotation named `<name>`. Once declared, it can be used as an argument of a symbol and will add the drawing in `<path>` to the symbol. In detail, the following happens:

**The Main Keys.** Two keys called `<name>` and `<name>'` are defined. The second causes the annotation to be “mirrored and placed on the other side” of the symbol. Both of these keys may also take further keys as parameter like `info` keys. Whenever the `<name>` key is used, a local scope is opened and in this scope the following things are done:

1. The style `every <name>` is executed.
2. The following style is executed and then `arrows=->`:

`/tikz/annotation arrow` (style, no value)

This style should set the `>` key to some desirable arrow tip.

3. The coordinate system is shifted such that the origin is at the north anchor of the symbol. (For the  $\langle name \rangle$ ' key the coordinate system is flipped and shifted such that the origin is at the south anchor of the symbol.)
4. The `label distance` is locally set to  $\langle distance \rangle$ .
5. The parameter options given to the  $\langle name \rangle$  key are executed.
6. The  $\langle path \rangle$  is executed.

**Usage.** What all of the above amounts to is best explained by an example. Suppose we wish to create an annotation that looks like a little circular arrow (like  $\textcircled{\curvearrowright}$ ). We could then say:

```
\tikzset{circuit declare annotation=
  {circular annotation}
  {9pt}
  {(0pt,8pt) arc (-270:80:3.5pt)}
}
```

We can then use it like this:

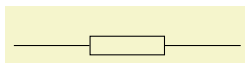

```
\tikz[circuit ee IEC]
\draw (0,0) to [resistor={circular annotation}] (3,0);
```

Well, not very impressive since we do not see anything. This is due to the fact that the  $\langle path \rangle$  becomes part of a path that contains the symbol node and nothing else. This path is not drawn or filled, so we do not see anything. What we must do is to use an `edge` path operation:

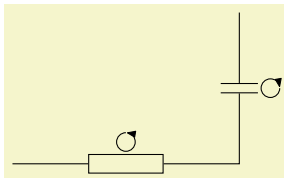

```
\tikzset{circuit declare annotation={circular annotation}{9pt}
  {(0pt,8pt) edge[to path={arc(-270:80:3.5pt)}] ()}
}
\tikz[circuit ee IEC]
\draw (0,0) to [resistor={circular annotation}] (3,0)
to [capacitor={circular annotation'}] (3,2);
```

The  $\langle distance \rangle$  is important for the correct placement of additional `info` labels. When an annotation is present, the `info` labels may need to be moved further away from the symbol, but not always. For this reason, an annotation defines an additional  $\langle distance \rangle$  that is applied to all `info` labels given as parameters to the annotation. Here is an example, that shows the difference:

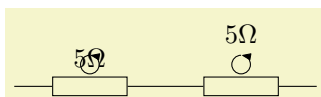

```
\tikz[circuit ee IEC]
\draw (0,0) to [resistor={circular annotation,ohm=5}] (2,0)
to [resistor={circular annotation={ohm=5}}] (4,0);
```

### 28.2.6 Theming Symbols

For each symbol, a certain graphical representation is chosen to actually show the symbol. You can modify this graphical representation in several ways:

- You can select a different library and use a different `circuit ...` key. This will change all graphics used for the symbols.
- You can generally change the size of graphic symbols by setting `circuit size unit` to a different value or using a key like `small circuit symbols`.
- You can add options to the graphics used by symbols either globally by setting the `every circuit symbol` style or locally by setting the `every`  $\langle name \rangle$  style, where  $\langle name \rangle$  is the name of a symbol. For instance, in the following picture the symbols are ridiculously thick and resistors are red.

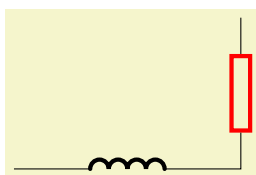

```
\begin{tikzpicture}
[circuit ee IEC,
every circuit symbol/.style={ultra thick},
every resistor/.style={red}]

\draw (0,0) to [inductor] ++(right:3) to [resistor] ++(up:2);
\end{tikzpicture}
```

- You can selectively change the graphic used for a symbol by saying `set resistor graphic=`.
- You can change one or more of the following styles:

`/tikz/circuit symbol open` (style, initially draw)

This style is used with symbols that consist of lines that surround some area. For instance, the IEC version of a resistor is an open symbol.

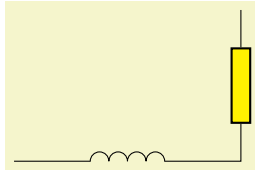

```
\tikz [circuit ee IEC,
      circuit symbol open/.style={thick,draw,fill=yellow}]
\draw (0,0) to [inductor] ++(right:3) to [resistor] ++(up:2);
```

`/tikz/circuit symbol filled` (style, initially draw,fill=black)

This style is used with symbols that are completely filled. For instance, the variant IEC version of an inductor is a filled, black rectangle.

`/tikz/circuit symbol lines` (style, initially draw)

This style is used with symbols that consist only of lines the do not surround anything. Examples are a capacitor.

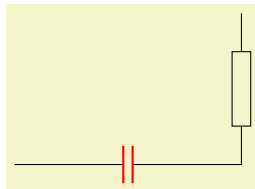

```
\tikz [circuit ee IEC,
      circuit symbol lines/.style={thick,draw=red}]
\draw (0,0) to [capacitor] ++(right:3) to [resistor] ++(up:2);
```

`/tikz/circuit symbol lines` (style, initially draw)

This style is used for symbols that consist only of “wires.” The difference to the previous style is that a symbol consisting of wires will look strange when the lines are thicker than the lines of normal wires, while for symbols consisting of lines (but not wires) it may look nice to make them thicker. An example is the `make contact` symbol.

Compare

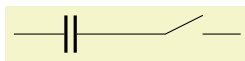

```
\tikz [circuit ee IEC,circuit symbol lines/.style={draw,very thick}]
\draw (0,0) to [capacitor={near start},
      make contact={near end}] (3,0);
```

to

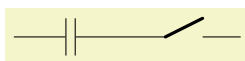

```
\tikz [circuit ee IEC,circuit symbol wires/.style={draw,very thick}]
\draw (0,0) to [capacitor={near start},
      make contact={near end}] (3,0);
```

All circuit environments like `circuit logic IEC` mainly use options like `set and gate graphic=...` to setup the graphics used for a certain symbol. It turns out that graphic hidden in the “...” part is also always available as a separate style, whose name contains the library’s initials. For instance, the `circuit logic IEC` option actually contains the following command:

```
set and gate graphic = and gate IEC graphic,
```

The `and gate IEC graphic` style, in turn, is defined as follows:

```
\tikzset{and gate IEC graphic/.style=
{
  circuit symbol open,
  circuit symbol size=width 2.5 height 4,
  shape=and gate IEC,
  inner sep=.5ex
}
}
```

Normally, you do not need to worry about this, since you will not need to access a style like `and gate IEC graphic` directly; you will only use the `and gate` key. However, sometimes libraries define *variants* of a graphic; for instance, there are two variants for the resistor graphic in the IEC library. In this case you can set the graphic for the resistor to this variant (or back to the original) by saying `set resistor graphic` yourself:

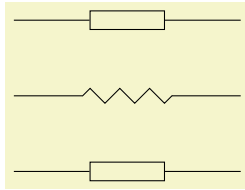

```
\begin{tikzpicture}[circuit ee IEC]
% Standard resistor
\draw (0,2) to [resistor] (3,2);

% Var resistor
\begin{scope}[set resistor graphic=var resistor IEC graphic]
\draw (0,1) to [resistor] (3,1);

% Back to original
\draw [set resistor graphic=resistor IEC graphic]
(0,0) to [resistor] (3,0);
\end{scope}
\end{tikzpicture}
```

## 28.3 Logical Circuits

### 28.3.1 Overview

A *logical circuit* is a circuit that contains what we call *logical gates* like an and-gate or an xor-gate. The logical libraries are intended to make it easy to draw such circuits.

In the following, we first have a look at the different libraries that can be used in principle and how the symbols look like. Then we have a more detailed look at how the symbols are used. Finally, we discuss the implementation details.

There are different ways of depicting logical gates, which is why there are different (sub-)libraries for drawing them. They provide the necessary graphical representations of the symbols declared in the following library:

```
\usetikzlibrary{circuits.logic} %  $\LaTeX$  and plain  $\TeX$ 
\usetikzlibrary[circuits.logic] % Con $\TeX$ t
```

This library declares the logical gate symbols, but does not provide the symbol graphics. The library also defines the following key which, however, is also only used indirectly, namely by other libraries:

`/tikz/circuit logic` (no value)

This style calls the keys `circuit` (which internally calls `every circuit`, then it defines the `inputs` key and it calls the `every circuit logic` key.

`/tikz/inputs=inputs` (no default)

This key is defined only inside the scope of a `circuit logic`. There, it has the same effect as `logic gate inputs`, described on page 299.

`/tikz/every circuit logic` (style, no value)

Use this key to configure the appearance of logical circuits.

Since the `circuit.logic` library does not define any actual graphics, you need to use one of the following libraries, instead:

```
\usepgflibrary{circuits.logic.IEC} %  $\LaTeX$  and plain  $\TeX$  and pure pgf
\usepgflibrary[circuits.logic.IEC] % Con $\TeX$ t and pure pgf
\usetikzlibrary{circuits.logic.IEC} %  $\LaTeX$  and plain  $\TeX$  when using TikZ
\usetikzlibrary[circuits.logic.IEC] % Con $\TeX$ t when using TikZ
```

This library provides graphics based on gates recommended by the International Electrotechnical Commission. When you include this library, you can use the following key to setup a scope that contains a logical circuit where the gates are shown in this style.

`/tikz/circuit logic IEC` (no value)

This key calls `circuit logic` and installs the IEC-like graphics for the logical symbols like `and gate`.





`/tikz/circuit logic CDH`

(no value)

This key calls `circuit logic US` and installs the two special and- and nand-gates, that is, it uses `set and gate graphic` with `and gate CDH graphic` and likewise for nand-gates.

Inside `circuit logic XYZ` scopes, you can now use the keys shown in Section 28.3.2. We have a more detailed look at one of them, all the other work the same way:

`/tikz/and gate`

(no value)

This key should be passed to a `node` command. It will cause the node to “look like” an and-gate, where the exact appearance of the gate is dictated by the which circuit environment is used. To further configure the appearance of the `and gate`, see Section 28.2.6.



```
\tikz [circuit logic IEC] \node [and gate] {$A$};
```

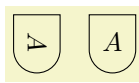

```
\tikz [circuit logic US]
{
  \node [and gate,point down] {$A$};
  \node [and gate,point down,info=center:$A$] at (1,0) {};
}
```

**Inputs.** Multiple inputs can be specified for a logic gate (provided they support multiple inputs: a not gate—also known as an inverter—does not). However, there is an upper limit for the number of inputs which has been set at 1024, which should be *way* more than would ever be needed.

The following key is used to configure the inputs. It is available only inside a `circuit logic` environment.

`/tikz/inputs=input list`

(no default, initially `{normal,normal}`)

If a gate has  $n$  inputs, the *input list* should consist of  $n$  letters, each being `i` for “inverted” or `n` for “normal.” Inverted gates will be indicated by a little circle. In any case the anchors for the inputs will be set up appropriately, numbered from top to bottom `input 1`, `input 2`, ... and so on. If the gate only supports one input the anchor is simply called `input` with no numerical index.

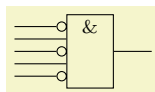

```
\begin{tikzpicture}[circuit logic IEC]
  \node[and gate,inputs={inini}] (A) {};
  \foreach \a in {1,...,5}
    \draw (A.input \a -| -1,0) -- (A.input \a);
  \draw (A.output) -- ++(right:5mm);
\end{tikzpicture}
```

(This key is just a shorthand for `logic gate inputs`, described in detail on page 299. There you will also find descriptions of how to configure the size of the inverted circles and the way the symbol size increases when there are too many inputs.)

**Output.** Every logic gate has one anchor called `output`.

### 28.3.2 Symbols: The Gates

The following table shows which symbols are declared by the main `circuits.logic` library and their appearance in the different sublibraries.

| Key               | Appearance inside<br>circuit logic IEC | Appearance inside<br>circuit logic US | Appearance inside<br>circuit logic CDH |
|-------------------|----------------------------------------|---------------------------------------|----------------------------------------|
| /tikz/and gate    |                                        |                                       |                                        |
| /tikz/nand gate   |                                        |                                       |                                        |
| /tikz/or gate     |                                        |                                       |                                        |
| /tikz/nor gate    |                                        |                                       |                                        |
| /tikz/xor gate    |                                        |                                       |                                        |
| /tikz/xnor gate   |                                        |                                       |                                        |
| /tikz/not gate    |                                        |                                       |                                        |
| /tikz/buffer gate |                                        |                                       |                                        |

### 28.3.3 Implementation: The Logic Gates Shape Library

The previous sections described the TikZ interface for creating logical circuits. In this section we take a closer look at the underlying PGF libraries.

Just as there are several TikZ circuit libraries, there are two underlying PGF shape libraries, one for creating US-style gates and one for IEC-style gates. These libraries define *shapes* only. It is the job of the circuit libraries to “theme” them so that they “look nice.” However, in principle, you can also use these shapes directly.

Let us begin with the base library that defines the handling of inputs.

```
\usepgflibrary{shapes.gates.logic} %  $\TeX$  and plain  $\TeX$  and pure pgf
\usepgflibrary[shapes.gates.logic] % Con $\TeX$ t and pure pgf
\usetikzlibrary{shapes.gates.logic} %  $\TeX$  and plain  $\TeX$  when using TikZ
\usetikzlibrary[shapes.gates.logic] % Con $\TeX$ t when using TikZ
```

This library defines common keys used by all logical gate shapes.

`/pgf/logic gate inputs=<input list>` (no default, initially {normal,normal})

Specify the inputs for for the logic gate. The keyword `inverted` indicates an inverted input which will mean PGF will draw a circle attached to the main shape of the logic gate. Any keyword that is not `inverted` will be treated as a “normal” or “non-inverted” input (however, for readability, you may wish to use `normal` or `non-inverted`), and PGF will not draw the circle. In both cases the anchors for the inputs will be set up appropriately, numbered from top to bottom `input 1`, `input 2`, ... and so on. If the gate only supports one input the anchor is simply called `input` with no numerical index.

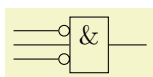

```
\begin{tikzpicture}[minimum height=0.75cm]
  \node[and gate IEC, draw, logic gate inputs={inverted, normal, inverted}]
    (A) {};
  \foreach \a in {1,...,3}
    \draw (A.input \a -| -1,0) -- (A.input \a);
  \draw (A.output) -- ([xshift=0.5cm]A.output);
\end{tikzpicture}
```

For multiple inputs it may be somewhat unweildy to specify a long list, thus, the following “short-hand” is permitted (this is an extension of ideas due to Juergen Werber and Christoph Bartoschek):

Using `i` for inverted and `n` for normal inputs,  $\langle input\ list \rangle$  can be specified *without the commas*. So, for example, `ini` is equivalent to `inverted, normal, inverted`.

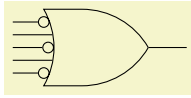

```
\begin{tikzpicture}[minimum height=0.75cm]
\node[or gate US, draw, logic gate inputs=inini] (A) {};
\foreach \a in {1,...,5}
\draw (A.input \a -| -1,0) -- (A.input \a);
\draw (A.output) -- ([xshift=0.5cm]A.output);
\end{tikzpicture}
```

The height of the gate may be increased to accommodate the number of inputs. In fact, it depends on three variables:  $n$ , the number of inputs,  $r$ , the radius of the circle used to indicate an inverted input and  $s$ , the distance between the centers of the inputs. The default height is then calculated according to the expression  $(n + 1) \times \max(2r, s)$ . This then may be increased to accommodate the node contents or any minimum size specifications.

The radius of the inverted input circle and the distance between the centers of the inputs can be customised using the following keys:

`/pgf/logic gate inverted radius= $\langle length \rangle$`  (no default, initially 2pt)

Set the radius of the circle that is used to indicate inverted inputs. This is also the radius of the circle used for the inverted output of the `nand`, `nor`, `xnor` and `not` gates.

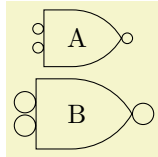

```
\begin{tikzpicture}[minimum height=0.75cm]
\tikzset{every node/.style={shape=nand gate CDH, draw, logic gate inputs=ii}}
\node[logic gate inverted radius=2pt] {A};
\node[logic gate inverted radius=4pt] at (0,-1) {B};
\end{tikzpicture}
```

`/pgf/logic gate input sep= $\langle length \rangle$`  (no default, initially .125cm)

Set the distance between the *centers* of the inputs to the logic gate.

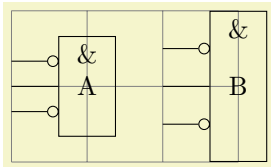

```
\begin{tikzpicture}[minimum size=0.75cm]
\draw [help lines] grid (3,2);
\tikzset{every node/.style={shape=and gate IEC, draw, logic gate inputs=ini}}
\node[logic gate input sep=0.33333cm] at (1,1) (A) {A};
\node[logic gate input sep=0.5cm] at (3,1) (B) {B};
\foreach \a in {1,...,3}
\draw (A.input \a -| 0,0) -- (A.input \a)
(B.input \a -| 2,0) -- (B.input \a);
\end{tikzpicture}
```

PGF will increase the size of the logic gate to accommodate the number of inputs, and the size of the inverted radius and the separation between the inputs. However with all shapes in this library, any increase in size (including any minimum size requirements) will be applied so that the default aspect ratio is unaltered. This means that changing the height will change the width and vice versa.

### 28.3.4 Implementation: The US-Style Logic Gates Shape Library

```
\usepgflibrary{shapes.gates.logic.US} %  $\mathbb{E}\mathbb{T}\mathbb{X}$  and plain  $\mathbb{T}\mathbb{E}\mathbb{X}$  and pure pgf
\usepgflibrary[shapes.gates.logic.US] % Con $\mathbb{T}\mathbb{E}\mathbb{X}$ t and pure pgf
\usetikzlibrary{shapes.gates.logic.US} %  $\mathbb{E}\mathbb{T}\mathbb{X}$  and plain  $\mathbb{T}\mathbb{E}\mathbb{X}$  when using TikZ
\usetikzlibrary[shapes.gates.logic.US] % Con $\mathbb{T}\mathbb{E}\mathbb{X}$ t when using TikZ
```

This library provides “American” logic gate shapes whose names are suffixed with the identifier `US`. Additionally, alternative `and` and `nand` gates are provided which are based on the logic symbols used in A. Croft, R. Davidson, and M. Hargreaves (1992), *Engineering Mathematics*, Addison-Wesley, 82–95. These two shapes are suffixed with `CDH`.

The “compass point” anchors apply to the main part of the shape and do not include any inverted inputs or outputs. This library provides an additional feature to facilitate the relative positioning of logic gates:

`/pgf/logic gate anchors use bounding box=<boolean>` (no default, initially false)

When set to `true` this key will ensure that the compass point anchors use the bounding rectangle of the main shape, which, ignore any inverted inputs or outputs, but includes any `outer sep`. This *only* affects the compass point anchors and is not set on a shape by shape basis: whether the bounding box is used is determined by value of this key when the anchor is accessed.

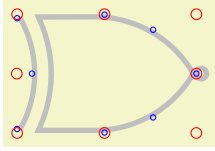

```
\begin{tikzpicture}[minimum height=1.5cm]
  \node[xnor gate US, draw, gray!50,line width=2pt] (A) {};
  \foreach \x/\y/\z in {false/blue/1pt, true/red/2pt}
    \foreach \a in {north, south, east, west, north east,
      south east, north west, south west}
      \draw[logic gate anchors use bounding box=\x, color=\y]
        (A.\a) circle(\z);
\end{tikzpicture}
```

The library defines a number of shapes. For each shape the allowed number of inputs is also shown:

- and gate US, two or more inputs
- and gate CDH, two or more inputs
- nand gate US, two or more inputs
- nand gate CDH, two or more inputs
- or gate US, two or more inputs
- nor gate US, two or more inputs
- xor gate US, two inputs
- xnor gate US, two inputs
- not gate US, one input
- buffer gate US, one input

In the following, we only have a detailed look at the anchors defined by one of them. We choose the `nand gate US` because it shows all the “interesting” anchors.

#### Shape `nand gate US`

This shape is a nand gate, which supports two or more inputs. If less than two inputs are specified an error will result. The anchors for this gate with two non-inverted inputs (using the normal compass point anchors) are shown below. Anchor 30 is an example of a border anchor.

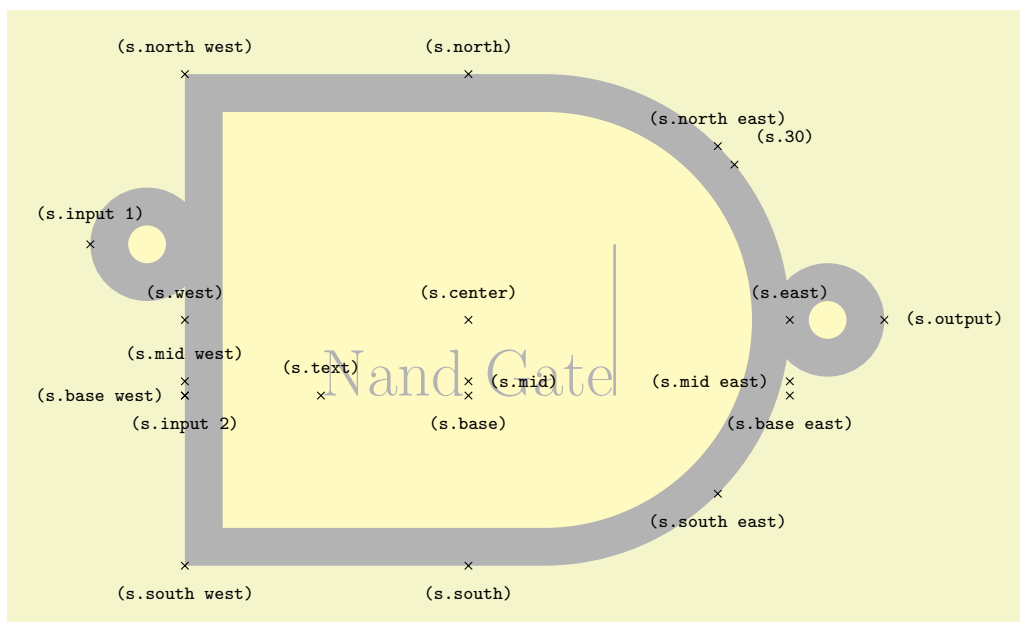

```

\Huge
\begin{tikzpicture}
  \node[name=s,shape=nand gate US,shape example, inner sep=0cm,
  logic gate inputs={in},
  logic gate inverted radius=.5cm] {Nand Gate\vrule width1pt height2cm};
  \foreach \anchor/\placement in
  {center/above, text/above, 30/above right,
  mid/right, mid east/left, mid west/above,
  base/below, base east/below, base west/left,
  north/above, south/below, east/above, west/above,
  north east/above, south east/below, south west/below, north west/above,
  output/right, input 1/above, input 2/below}
  \draw[shift=(s.\anchor)] plot[mark=x] coordinates{(0,0)}
  node[\placement] {\scriptsize\texttt{(s.\anchor)}};
\end{tikzpicture}

```

### 28.3.5 Implementation: The IEC-Style Logic Gates Shape Library

```

\usepgflibrary{shapes.gates.logic.IEC} %  $\TeX$  and plain  $\TeX$  and pure pgf
\usepgflibrary[shapes.gates.logic.IEC] % Con $\TeX$ t and pure pgf
\usetikzlibrary{shapes.gates.logic.IEC} %  $\TeX$  and plain  $\TeX$  when using TikZ
\usetikzlibrary[shapes.gates.logic.IEC] % Con $\TeX$ t when using TikZ

```

This library provides rectangular logic gate shapes. These shapes are suffixed with IEC as they are based on gates recommended by the International Electrotechnical Commission.

By default each gate is drawn with a symbol, & for and and nand gates,  $\geq 1$  for or and nor gates, 1 for not and buffer gates, and = 1 for xor and xnor gates. These symbols are drawn automatically (internally they are drawn using the “foreground” path), and are not strictly speaking part of the node contents. However, the gate is enlarged to make sure the symbols are within the border of the node. It is possible to change the symbols and their position within the node using the following keys:

**/pgf/and gate IEC symbol=*text*** (no default, initially  $\backslash\text{char}\backslash\&$ )

Set the symbol for the and gate. Note that if the node is filled, this color will be used for the symbol, making it invisible, so it will be necessary set *text* to something like  $\backslash\text{color}\{\text{black}\}\backslash\text{char}\backslash\&$ . Alternatively, the logic gate IEC symbol color key can be used to set the color of all symbols simultaneously.

In TikZ, when the use IEC style logic gates key has been used, this key can be replaced by and gate symbol.

**/pgf/nand gate IEC symbol=*text*** (no default, initially  $\backslash\text{char}\backslash\&$ )

Set the symbol for the nand gate. In TikZ, when the use IEC style logic gates key has been used, this key can be replaced by nand gate symbol.

**/pgf/or gate IEC symbol=*text*** (no default, initially  $\mathbb{S}\geq 1$ )

Set the symbol for the or gate. In TikZ, when the use IEC style logic gates key has been used, this key can be replaced by or gate symbol.

**/pgf/nor gate IEC symbol=*text*** (no default, initially  $\mathbb{S}\geq 1$ )

Set the symbol for the nor gate. In TikZ, when the use IEC style logic gates key has been used, this key can be replaced by nor gate symbol.

**/pgf/xor gate IEC symbol=*text*** (no default, initially  $\{\mathbb{S}=1\}$ )

Set the symbol for the xor gate. Note the necessity for braces, as the symbol contains =. In TikZ, when the use IEC style logic gates key has been used, this key can be replaced by or gate symbol.

**/pgf/xnor gate IEC symbol=*text*** (no default, initially  $\{\mathbb{S}=1\}$ )

Set the symbol for the xnor gate. In TikZ, when the use IEC style logic gates key has been used, this key can be replaced by xnor gate symbol.

**/pgf/not gate IEC symbol=*text*** (no default, initially 1)

Set the symbol for the `not gate`. In TikZ, when the `use IEC style logic gates` key has been used, this key can be replaced by `not gate symbol`.

`/pgf/buffer gate IEC symbol=<text>` (no default, initially 1)

Set the symbol for the `buffer gate`. In TikZ, when the `use IEC style logic gates` key has been used, this key can be replaced by `buffer gate symbol`.

`/pgf/logic gate IEC symbol align=<align>` (no default, initially top)

Set the alignment of the logic gate symbol (in TikZ, when the `use IEC style logic gates` key has been used, IEC can be omitted. The specification in `<align>` is a comma separated list from `top`, `bottom`, `left` or `right`. The distance between the border of the node and the outer edge of the symbol is determined by the values of the `inner xsep` and `inner ysep`.

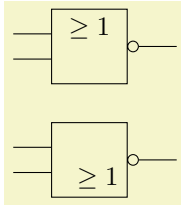

```
\begin{tikzpicture}[minimum size=1cm, use IEC style logic gates]
\tikzset{every node/.style={nor gate, draw}}
\node (A) at (0,1.5) {};
\node [logic gate symbol align={bottom, right}] (B) at (0,0) {};
\foreach \g in {A, B}{
  \foreach \i in {1,2}
    \draw ([xshift=-0.5cm]\g.input \i) -- (\g.input \i);
  \draw (\g.output) -- ([xshift=0.5cm]\g.output);
}
\end{tikzpicture}
```

`/pgf/logic gate IEC symbol color=<color>` (no default)

This key sets the color for all symbols simultaneously. This color can be overridden on a case by case basis by specifying a color when setting the symbol text.

The library defines the following shapes:

- `and gate IEC`, two or more inputs
- `nand gate IEC`, two or more inputs
- `or gate IEC`, two or more inputs
- `nor gate IEC`, two or more inputs
- `xor gate IEC`, two inputs
- `xnor gate IEC`, two inputs
- `not gate IEC`, one input
- `buffer gate IEC`, one input

Again, we only have a look at the nand-gate in more detail:

Shape `nand gate IEC`

This shape is a nand gate. It supports two or more inputs. If less than two inputs are specified an error will result. The anchors for this gate with two non-inverted inputs are shown below. Anchor 30 is an example of a border anchor.

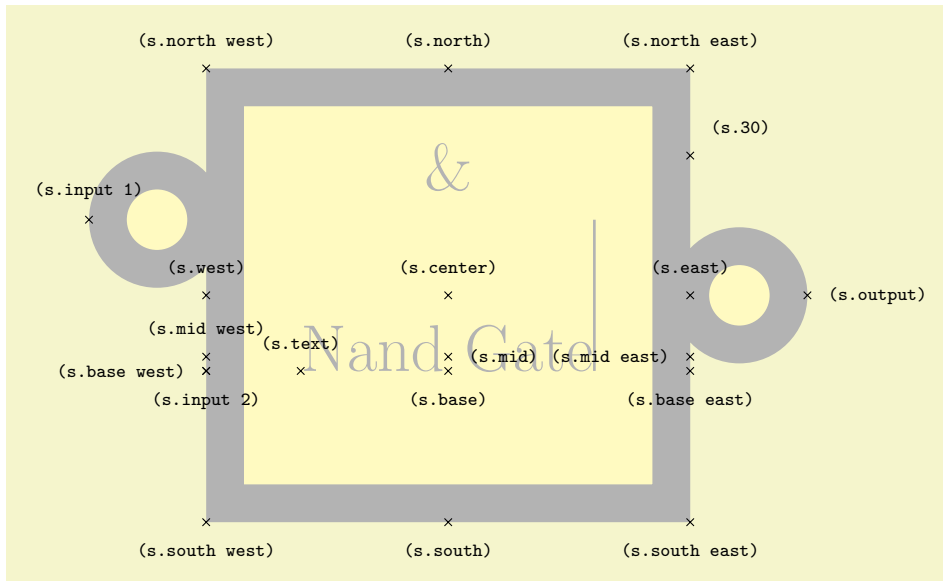

```

\Huge
\begin{tikzpicture}
  \node[name=s,shape=nand gate IEC ,shape example, inner xsep=1cm, inner ysep=1cm,
    minimum height=6cm, nand gate IEC symbol=\color{black!30}\char'\&,
    logic gate inputs={in},
    logic gate inverted radius=0.65cm]
  {Nand Gate\vrule width1pt height2cm};
  \foreach \anchor/\placement in
  {center/above, text/above, 30/above right,
  mid/right, mid east/left, mid west/above,
  base/below, base east/below, base west/left,
  north/above, south/below, east/above, west/above,
  north east/above, south east/below, south west/below, north west/above,
  output/right, input 1/above, input 2/below}
  \draw[shift=(s.\anchor)] plot[mark=x] coordinates{(0,0)}
  node[\placement] {\scriptsize\texttt{(s.\anchor)}};
\end{tikzpicture}

```

## 28.4 Electrical Engineering Circuits

### 28.4.1 Overview

An *electrical engineering circuit* contains symbols like resistors or capacitors or voltage sources and annotations like the two arrows pointing toward an element whose behaviour is light dependent. The electrical engineering libraries, abbreviated ee-libraries, provide such symbols and annotations.

Just as for logical gates, there are different ways of drawing ee-symbols. Currently, there is one main library for drawing circuits, which uses the graphics from the International Electrotechnical Commission, but you can add your own libs. This is why, just as for logical gates, there are a base library and more specific libraries.

```

\usetikzlibrary{circuits.ee} % LATEX and plain TEX
\usetikzlibrary[circuits.ee] % ConTEXt

```

This library declares the ee symbols, but (mostly) does not provide the symbol graphics, which is left to the sublibraries. Just like the logical gates library, a key is defined that is normally only used internally:

```
/tikz/circuit ee (no value)
```

This style calls the keys `circuit` (which internally calls `every circuit` and the following style:

```
/tikz/every circuit ee (style, no value)
```

Use this key to configure the appearance of logical circuits.

The library also declares some standard annotations and units.

As for logical circuits, to draw a circuit the first step is to include a library containing the symbols graphics. Currently, you have to include `circuits.ee.IEC`.



```
\usetikzlibrary{circuit.ee.IEC} %  $\LaTeX$  and plain  $\TeX$ 
\usetikzlibrary[circuit.ee.IEC] % Con $\TeX$ t
```

When this library is loaded, you can use the following style:

```
/tikz/circuit ee IEC (no value)
```

This style calls `circuit ee` and installs the IEC-like graphics for the logical symbols like `resistor`.

Inside the `circuit ee IEC` scope, you can now use the keys for symbols, units, and annotations listed in the later sections. We have a more detailed look at one of each of them, all the other work the same way.

Let us start with an example of a symbol: the resistor symbol. The other predefined symbols are listed in Section 28.4.2 and later sections.

```
/tikz/resistor=<options> (no default)
```

This key should be used with a `node` path command or with the `to` path command.

**Using the Key with Normal Nodes.** When used with a node, it will cause this node to “look like” a resistor (by default, in the IEC library, this is just a simple rectangle).



```
\tikz [circuit ee IEC]
\node [resistor] {};
```

Unlike normal nodes, a resistor node generally should not take any text (as in `node [resistor] {foo}`). Instead, the labelling of resistors should be done using the `label`, `info` and `ohm` options.



```
\tikz [circuit ee IEC]
\node [resistor,ohm=5] {};
```

The *<options>* make no real sense when the `resistor` option is used with a normal node, you can just as well given them to the `node` itself. Thus, the following has the same effect as the above example:



```
\tikz [circuit ee IEC]
\node [resistor={ohm=5}] {};
```

In a circuit, you will often wish to rotate elements. For this, the options `point up`, `point down`, `point left` or `point right` may be especially useful. They are just shorthands for appropriate rotations like `rotate=90`.



```
\tikz [circuit ee IEC] {
\node (R1) [resistor,point up,ohm=5] at (3,1) {};
\node (R2) [resistor,ohm=10k] at (0,0) {};
\draw (R2) -| (R1);
}
```

**Using the Key on a To Path.** When the `resistor` key is used on a `to` path inside a `circuit ee IEC`, the `circuit handle symbol` key is called internally. This has a whole bunch of effects:

1. The path currently being constructed is cut up to make place for a node.
2. This node will be a `resistor node` that is rotated so that it points “along” the path (unless an option like `shift only` or an extra rotation is used to change this).
3. The *<options>* passed to the `resistor` key are passed on to the node.
4. The *<options>* are pre-parsed to indentify a `pos` key or a key like `at start` or `midway`. These keys are used to determine where on the `to` path the node will lie.

Since the *<options>* of the `resistor` key are passed on to the resistor node on the path, you can use it to add labels to the node. Here is a simple example:

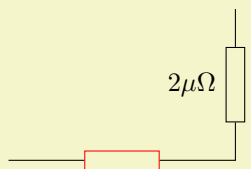

```
\tikz [circuit ee IEC]
\draw (0,0) to [resistor=red] (3,0)
to [resistor={ohm=2\mu}] (3,2);
```

You can add multiple labels to a resistor and you can have multiple resistors (or other elements) on a single path.

**Inputs, Outputs, and Anchors.** Like the logical gates, all ee-symbols have an `input` and an `output` anchor. Special purpose nodes may have even more anchors of this type. Furthermore, the ee-symbols nodes also for standard compass direction anchors.

**Changing the Appearance.** To configure the appearance of all `resistors`, see Section 28.2.6. You can use the `<options>` to locally change the appearance of a single resistor.

Let us now have a look at an example of a unit: the Ohm unit. The other predefined units are listed in Section 28.4.6.

`/tikz/ohm=<value>` (no default)

This key is used to add an `info` label to a node with a special text:  $\mathrm{\langle value \rangle \Omega}$ . In other words, the `ohm` key can only be used with the options of a node and, when used, it will cause the `<value>` to be placed next to the node, followed by  $\Omega$ . Since the `<value>` is typeset inside a `\mathrm` command, when you write `ohm=5k` you get  $5\text{k}\Omega$ , `ohm=5p` yields  $5\text{p}\Omega$ , and `ohm=5.6\cdot 10^2\mu` yields  $5.6 \cdot 10^2 \mu\Omega$ .

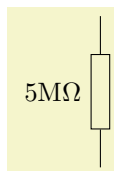

```
\tikz [circuit ee IEC] \draw (0,0) to [resistor={ohm=5M}] (0,2);
```

Instead of `ohm` you can also use `ohm'`, which places the label on the other side.

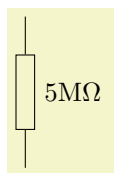

```
\tikz [circuit ee IEC] \draw (0,0) to [resistor={ohm'=5M}] (0,2);
```

Finally, there are also keys `ohm sloped` and `ohm' sloped` for having the info label rotate together with the main node.

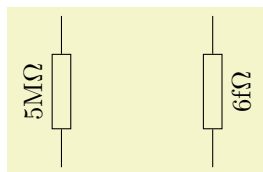

```
\tikz [circuit ee IEC]
\draw (0,0) to [resistor={ohm sloped=5M}] (0,2)
(2,0) to [resistor={ohm' sloped=6f}] (2,2);
```

You can configure the appearance of an Ohm info label using the key `every ohm`.

Finally, let us have a look at an annotation: the `light emitting` annotation. The other predefined units are listed in Section 28.4.7.

`/tikz/light emitting=<options>` (no default)

Like a unit, an annotation should be given as an additional option to a node. It causes some drawings (in this case, two parallel lines) to be placed next to the node.

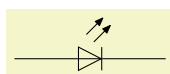

```
\tikz [circuit ee IEC] \draw (0,0) to [diode=light emitting] (2,0);
```

The `<options>` can be used for three different things:

1. You can use keys like `red` to change the appearance of this annotation, locally.
2. You can use keys like `<-` or `-latex` to change the direction and kinds of arrows used in the annotation.

3. You can use info labels like `ohm=5` or `info=foo` inside the `\options`. These info labels will be added to the main node (not to the annotation itself), but the label distance will have been changed to accomodate for the space taken up by the annotation.

|  |                                                                                                                                                                                                              |
|--|--------------------------------------------------------------------------------------------------------------------------------------------------------------------------------------------------------------|
|  | <pre>\tikz [circuit ee IEC] {   \draw (0,2) to [diode={light emitting,info=not good}] (2,2);   \draw (0,0) to [diode={light emitting={info=better},                         info'=also good}] (2,0); }</pre> |
|--|--------------------------------------------------------------------------------------------------------------------------------------------------------------------------------------------------------------|

In addition to `light emitting` there is also a key called `light emitting'`, which simply places the annotation on the other side of the node.

You can configure the appearance of annotations in three ways:

- You can set the `every circuit annotation style`.
- You can set the `every light emitting style`.
- You can set the following key:

`/tikz/annotation arrow` (style, no value)

This style should set the default `>` arrow to some nice value.

### 28.4.2 Symbols: Indicating Current Directions

There are two symbols for indicating current directions. These symbols are defined directly inside `circuit ee`.

| <i>Key</i>                            | <i>Appearance</i> |
|---------------------------------------|-------------------|
| <code>/tikz/current direction</code>  |                   |
| <code>/tikz/current direction'</code> |                   |

The examples have been produced by (in essence) `\draw (0,0) to[symbol name] (3,0);`.











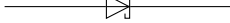

### 28.4.3 Symbols: Basic Elements

The following table show basic symbols as they are depicted inside the `circuit ee IEC` environment. To install one of alternate graphics, you have to say `set <symbol name> graphic=var <symbol name> IEC graphic`.

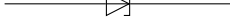
| <i>Key</i>                        | <i>Appearance</i> | <i>Alternate appearance</i> |
|-----------------------------------|-------------------|-----------------------------|
| <code>/tikz/resistor</code>       |                   |                             |
| <code>/tikz/inductor</code>       |                   |                             |
| <code>/tikz/capacitor</code>      |                   |                             |
| <code>/tikz/battery</code>        |                   |                             |
| <code>/tikz/bulb</code>           |                   |                             |
| <code>/tikz/current source</code> |                   |                             |
| <code>/tikz/voltage source</code> |                   |                             |
| <code>/tikz/ground</code>         |                   |                             |

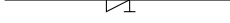

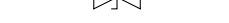

### 28.4.4 Symbols: Diodes

The following table shows diodes as they are depicted inside the `circuit ee IEC` environment.

| <i>Key</i>            | <i>Appearance</i>                                                                 | <i>Alternate appearance</i>                                                        |
|-----------------------|-----------------------------------------------------------------------------------|------------------------------------------------------------------------------------|
| /tikz/diode           |  |  |
| /tikz/Zener diode     |  |  |
| /tikz/Schottky diode  |  |  |
| /tikz/tunnel diode    |  |  |
| /tikz/backward diode  |  |  |
| /tikz/breakdown diode |  |  |

### 28.4.5 Symbols: Contacts

The following table shows contacts as they are depicted inside the `circuit.ee` IEC environment.

| <i>Key</i>          | <i>Appearance</i>                                                                 | <i>Alternate appearance</i>                                                        |
|---------------------|-----------------------------------------------------------------------------------|------------------------------------------------------------------------------------|
| /tikz/contact       |  |                                                                                    |
| /tikz/make contact  |  |  |
| /tikz/break contact |  |                                                                                    |



### 28.4.6 Units

The `circuit.ee` library predefines the following unit keys:

| <i>Key</i>       | <i>Appearance of 1 unit</i> |
|------------------|-----------------------------|
| /tikz/ampere     | 1A                          |
| /tikz/volt       | 1V                          |
| /tikz/ohm        | 1Ω                          |
| /tikz/siemens    | 1S                          |
| /tikz/henry      | 1H                          |
| /tikz/farad      | 1F                          |
| /tikz/coulomb    | 1C                          |
| /tikz/voltampere | 1VA                         |
| /tikz/watt       | 1W                          |
| /tikz/hertz      | 1Hz                         |

### 28.4.7 Annotations

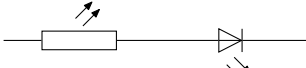
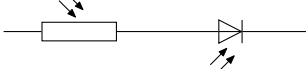
The `circuit.ee.IEC` library defines the following annotations:

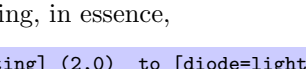
| <i>Key</i>            | <i>Appearance</i>                                                                   |
|-----------------------|-------------------------------------------------------------------------------------|
| /tikz/light emitting  |  |
| /tikz/light dependent |  |
| /tikz/direction info  |  |
| /tikz/adjustable      |  |

The lines have been produced using, in essence,

```
\draw (0,0) to [resistor=light emitting] (2,0) to [diode=light emitting'] (4,0);
```

and similarly for the other annotations.

### 28.4.8 Implementation: The EE-Symbols Shape Library

The TikZ libraries depend on two shape libraries, which are included automatically. Usually, you will not need to use these shapes directly.

```
\usepgflibrary{shapes.gates.ee} %  $\TeX$  and plain  $\TeX$  and pure pgf
\usepgflibrary[shapes.gates.ee] % Con $\TeX$ t and pure pgf
\usetikzlibrary{shapes.gates.ee} %  $\TeX$  and plain  $\TeX$  when using TikZ
```

`\usetikzlibrary[shapes.gates.ee]` % Context when using TikZ

This library defines basic shapes that can be used by all ee-circuit libraries. Currently, it defines the following shapes:

- `rectangle ee`
- `circle ee`
- `direction ee`

Additionally, the library defines the following arrow tip: The `direction ee` arrow tip is basically the same as a `triangle 45` arrow tip with rounded joins.

`direction ee` yields thick  and thin 

However, unlike normal arrow tips, its size does *not* depend on the current line width. Rather, it depends on the value of its arrow options, which should be set to the desired size. Thus, you should say something like `\pgfsetarrowoptions{direction ee}{5pt}` to set the size of the arrow.

#### Shape `rectangle ee`

This shape is completely identical to a normal `rectangle`, only there are two additional anchors: The `input` anchor is an alias for the `west` anchor, while the `output` anchor is an alias for the `east` anchor.

#### Shape `circle ee`

Like the `rectangle ee` shape, only for circles.

#### Shape `direction ee`

This shape is rather special. It is intended to be used to “turn an arrow tip into a shape.” First, you should set the following key to the name of an arrow tip:

`/pgf/direction ee arrow=<right arrow tip name>` (no default)

The value of this key will be used for the arrow tip depicted in an `direction ee` shape.

When a node of shape `direction ee` is created, several things happen:

1. The size of the shape is computed according to the following rules: The width of the shape is setup so that the left border of the shape is at the left end of the arrow tip and the right border is at the right end of the arrow tip. These left and right “ends” of the arrow are the left and right extends specified by the arrow itself (see the documentation of the `\pgfarrowdeclare` for details). You usually need not worry about this width setting.  
By comparison, the height of the arrow is given by the current setting of `minimum height`. Thus, this key must have been setup correctly to reflect the “real” height of the arrow tip. The reason is that the height of an arrow is not specified when arrows are declared and is, thus, not available, here.  
Possibly, the height computation will change in the future to reflect the real height of the arrow, so you should generally setup the `minimum height` to be the same as the real height.
2. A straight line from left to right inside the shape’s boundaries is added to the background path.
3. The arrow tip, pointing right, is drawn before the background path.

The anchors of this shape are just the compass anchors, which lie on a rectangle whose width and height are the above-computed height and width.

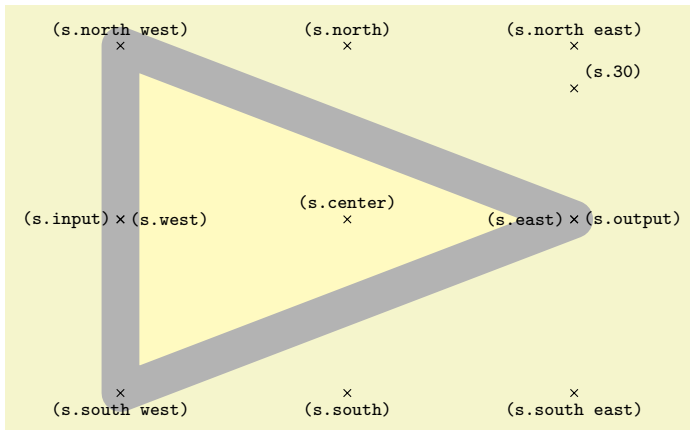

```

\begin{tikzpicture}
\pgfsetarrowoptions{direction ee}{6cm}
\node[name=s,shape=direction ee,shape example,minimum height=0.7654*6cm] {};
\foreach \anchor/\placement in
{center/above, 30/above right,
north/above, south/below, east/left, west/right,
north east/above, south east/below, south west/below, north west/above,
input/left,output/right}
\draw[shift=(s.\anchor)] plot[mark=x] coordinates{(0,0)}
node[\placement] {\scriptsize\texttt{(s.\anchor)}};
\end{tikzpicture}

```

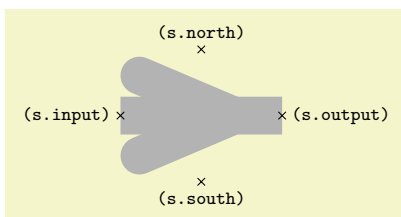

```

\begin{tikzpicture}[direction ee arrow=angle 45]
\node[name=s,shape=direction ee,shape example,minimum height=1.75cm] {};
\foreach \anchor/\placement in {north/above, south/below,
output/right, input/left}
\draw[shift=(s.\anchor)] plot[mark=x] coordinates{(0,0)}
node[\placement] {\scriptsize\texttt{(s.\anchor)}};
\end{tikzpicture}

```

### 28.4.9 Implementation: The IEC-Style EE-Symbols Shape Library

```

\usepgflibrary{shapes.gates.ee.IEC} %  $\TeX$  and plain  $\TeX$  and pure pgf
\usepgflibrary[shapes.gates.ee.IEC] % Con $\TeX$ t and pure pgf
\usetikzlibrary{shapes.gates.ee.IEC} %  $\TeX$  and plain  $\TeX$  when using TikZ
\usetikzlibrary[shapes.gates.ee.IEC] % Con $\TeX$ t when using TikZ

```

This library defines shapes for depicting ee symbols according to the IEC recommendations. These shapes will typically be used in conjunction with the graphic mechanism detailed earlier, but you can also use them directly.

#### Shape `generic circle IEC`

This shape inherits from `circle ee`, which in turn is just a normal `circle` with additional `input` and `output` anchors at the left and right ends. However, additionally, this shape allows you to specify a path that should be added before the background path using the following key:

`/pgf/generic circle IEC/before background=<code>` (no default)

When a node of shape `generic circle IEC` is created, the current setting of this key is used as the “before background path.” This means that after the circle’s background has been drawn/filled/whatever, the `<code>` is executed.

When the `<code>` is executed, the coordinate system will have been transformed in such a way that

the point (1pt,0pt) lies at the right end of the circle and (0pt,1pt) lies at the top of the circle. (More precisely, these points will lie exactly on the middle of the radial line.)

Here is an examples of how to use this shape:

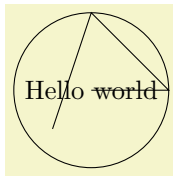

```
\tikz \node [generic circle IEC,
/pgf/generic circle IEC/before background={
\pgfpathmoveto{\pgfpointorigin}
\pgfpathlineto{\pgfpoint{1pt}{0pt}}
\pgfpathlineto{\pgfpoint{0pt}{1pt}}
\pgfpathlineto{\pgfpoint{-0.5pt}{-0.5pt}}
\pgfusepathqstroke
},
draw] {Hello world};
```

### Shape `generic diode IEC`

This shape is used to depict diodes. The main shape is taken up by a “right pointing” triangle. The anchors are positioned on border of a rectangle around the diode, see the below example. The diode’s size is based on the current settings of `minimum width` and `minimum height`.

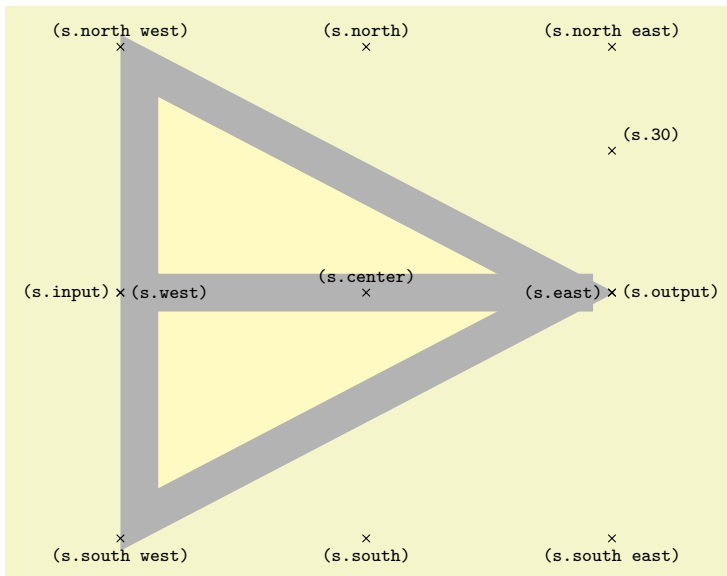

```
\begin{tikzpicture}
\node[name=s,shape=generic diode IEC,shape example,minimum size=6cm] {};
\foreach \anchor/\placement in
{center/above, 30/above right,
north/above, south/below, east/left, west/right,
north east/above, south east/below, south west/below, north west/above,
input/left,output/right}
\draw[shift=(s.\anchor)] plot[mark=x] coordinates{(0,0)}
node[\placement] {\scriptsize\texttt{(s.\anchor)}};
\end{tikzpicture}
```

This shape, like the `generic circle IEC` shape, is generic in the sense that there is a special key that is used for the before background drawings:

`/pgf/generic diode IEC/before background=<code>` (no default)

Similarly to the `generic circle IEC` shape, when a node of shape `generic diode IEC` is created, the current setting of this key is used as the “before background path.” When the `<code>` is executed, the coordinate system will have been transformed in such a way that the origin is at the “tip” of the diode’s triangle, the point (0pt,1pt) is exactly half the diode’s height above this origin, and the point (1pt,0pt) is half the diode’s height to the right of the origin.

The idea is that you use this key to draw different kinds of diode endings.

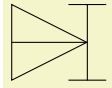

```
\tikz \node [minimum size=1cm,generic diode IEC,
/pgf/generic diode IEC/before background={
\pgfpathmoveto{\pgfqpoint{-.5pt}{-1pt}}
\pgfpathlineto{\pgfqpoint{.5pt}{-1pt}}
\pgfpathmoveto{\pgfqpoint{0pt}{-1pt}}
\pgfpathlineto{\pgfqpoint{0pt}{1pt}}
\pgfpathmoveto{\pgfqpoint{-.5pt}{1pt}}
\pgfpathlineto{\pgfqpoint{.5pt}{1pt}}
\pgfusepathqstroke
},
draw] {};
```

### Shape `breakdown diode IEC`

This shape is used to depict a bidirectional breakdown diode. The diode's size is based on the current settings of minimum width and minimum height.

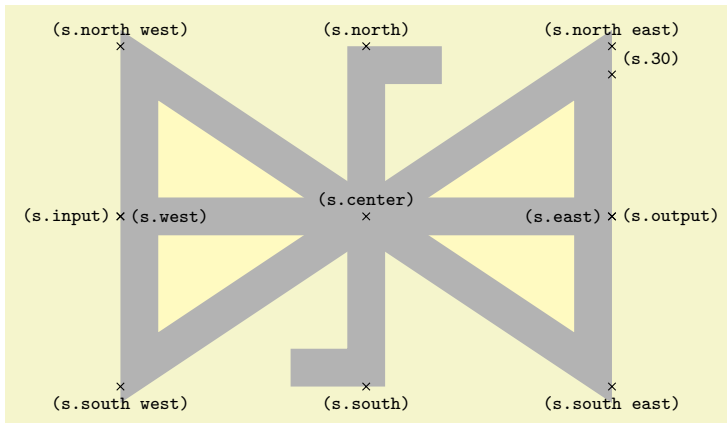

```
\begin{tikzpicture}
\node[name=s,shape=breakdown diode IEC,shape example,minimum width=6cm,minimum height=4cm] {};
\foreach \anchor/\placement in
{center/above, 30/above right,
north/above, south/below, east/left, west/right,
north east/above, south east/below, south west/below, north west/above,
input/left,output/right}
\draw[shift=(s.\anchor)] plot[mark=x] coordinates{(0,0)}
node[\placement] {\scriptsize\texttt{(s.\anchor)}};
\end{tikzpicture}
```

### Shape `var resistor IEC`

This shape is used to depict a variant version of a resistor. Its size is computed as for a rectangle (thus, its size depends things like the minimum height). Then, inside this rectangle, a background path is setup according to the following rule: Starting from the left end, zig-zag segments are added to the path. Each segment consists of a line at a 45 degree angle going up to the top of the rectangle, then going down to the bottom, then going up to mid height of the node. As many segments as possible are put inside as possible. The last segment is then connected to the output anchor via a straight line.

All of this means that, in general, the shape should be much wider than high.

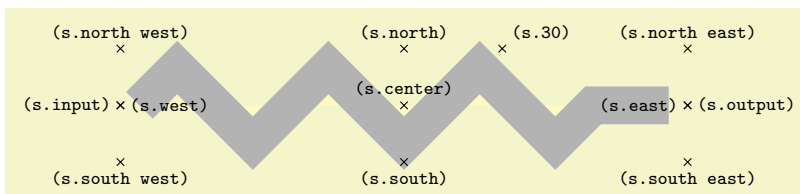



```

\begin{tikzpicture}
  \node[name=s,shape=var resistor IEC,shape example,minimum width=7cm,minimum height=1cm] {};
  \foreach \anchor/\placement in
    {center/above, 30/above right,
     north/above, south/below, east/left, west/right,
     north east/above, south east/below, south west/below, north west/above,
     input/left,output/right}
    \draw[shift=(s.\anchor)] plot[mark=x] coordinates{(0,0)}
      node[\placement] {\scriptsize\texttt{(s.\anchor)}};
\end{tikzpicture}

```

### Shape **inductor IEC**

This shape is used to depict an inductor, using a bumpy line. Its size is computed as follows: Any text and `inner sep` are ignored (and should normally not be given). The `minimum height` plus (twice) the `outer ysep` specify the distance between the north and south anchors, similarly for the `minimum width` plus the `outer xsep` for the east and west. The bumpy line is drawn starting from the lower left corner to the lower right corner with bumps being half-circles whose height is exactly the `minimum height`. The center of the shape is just above the south anchor, at a distance of the `outer ysep`.

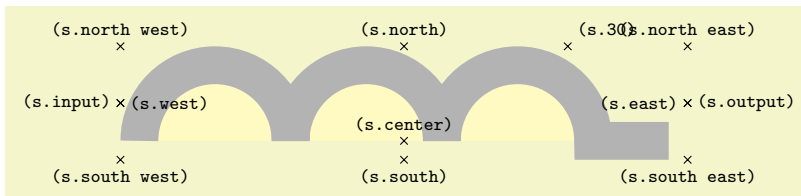

```

\begin{tikzpicture}
  \node[name=s,shape=inductor IEC,shape example,minimum width=7cm,minimum height=1cm] {};
  \foreach \anchor/\placement in
    {center/above, 30/above right,
     north/above, south/below, east/left, west/right,
     north east/above, south east/below, south west/below, north west/above,
     input/left,output/right}
    \draw[shift=(s.\anchor)] plot[mark=x] coordinates{(0,0)}
      node[\placement] {\scriptsize\texttt{(s.\anchor)}};
\end{tikzpicture}

```

Just as for a `var resistor IEC`, as many bumps as possible are added and the last bump is connected to the output anchor via a straight line.

### Shape **capacitor IEC**

This shape is based on a `rectangle ee`. However, instead of a rectangle as the background path, only the “left and right lines” that make up the rectangle are drawn.

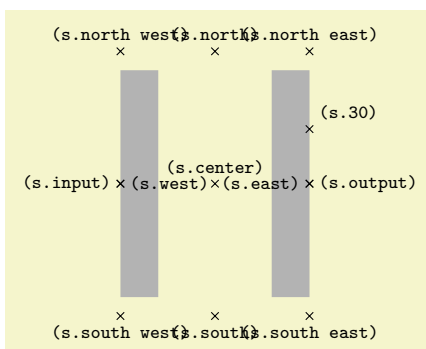

```

\begin{tikzpicture}
  \node[name=s,shape=capacitor IEC,shape example,
    minimum width=2cm,minimum height=3cm,inner sep=0pt] {};
  \foreach \anchor/\placement in
    {center/above, 30/above right,
    north/above, south/below, east/left, west/right,
    north east/above, south east/below, south west/below, north west/above,
    input/left,output/right}
    \draw[shift=(s.\anchor)] plot[mark=x] coordinates{(0,0)}
      node[\placement] {\scriptsize\texttt{(s.\anchor)}};
\end{tikzpicture}

```

### Shape **battery IEC**

This shape is similar to a **capacitor IEC**, only the right line is only half the height of the left line.

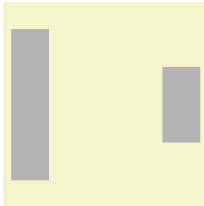

```

\tikz \node[shape=battery IEC,shape example,minimum size=2cm,
  inner sep=0pt] {};

```

### Shape **ground IEC**

This shape is similar to a **batter IEC**, only three lines of different heights are drawn.



```

\tikz \node[shape=ground IEC,shape example,minimum size=2cm,
  inner sep=0pt] {};

```

### Shape **make contact IEC**

This shape consists of a line going from the lower left corner to the upper right corner. The size and anchors of this shape are computed in the same way as for an **inductor IEC**.

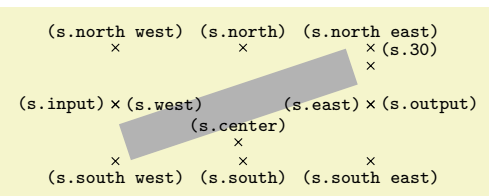

```

\begin{tikzpicture}
  \node[name=s,shape=make contact IEC,shape example,minimum width=3cm,minimum height=1cm] {};
  \foreach \anchor/\placement in
    {center/above, 30/above right,
    north/above, south/below, east/left, west/right,
    north east/above, south east/below, south west/below, north west/above,
    input/left,output/right}
    \draw[shift=(s.\anchor)] plot[mark=x] coordinates{(0,0)}
      node[\placement] {\scriptsize\texttt{(s.\anchor)}};
\end{tikzpicture}

```

### Shape **var make contact IEC**

This shape works like **make contact IEC**, only a little circle is added to the path at the lower left corner. The radius of this circle is one twelfth of the width of the node.



```

\tikz \node[shape=var make contact IEC,shape example,
  minimum height=1cm,minimum width=3cm,inner sep=0pt] {};

```

Shape **break contact IEC**

This shape depicts a contact that can be broken. It works like `make contact IEC`.



```
\tikz \node[shape=break contact IEC,shape example,  
           minimum height=1cm,minimum width=3cm,inner sep=0pt] {};
```

## 29 Decoration Library

### 29.1 Overview and Common Options

The decoration libraries define a number of (more or less useful) decorations that can be applied to paths. The usage of decorations is not covered in the present section, please consult Sections 21, which explains how decorations are used in `TikZ`, and 72, which explains how new decorations can be defined.

The decorations are influenced by a number of parameters that can be set using the `decoration` option. These parameters are typically shared between different decorations. In the following, the general options are documented (they are defined directly in the `decoration` module), special-purpose keys are documented with the decoration that uses it.

Since you are encouraged to use these keys to make your own decorations configurable, it is indicated for each key where the value is stored (so that you can access it). Note that some values are stored in  $\TeX$  dimension registers while others are stored in macros.

`/pgf/decoration/amplitude=<dimension>` (no default, initially 2.5pt)

This key determines the “desired height” (or amplitude) of decorations for which this makes sense. For instance, the initial value of 2.5pt means that deforming decorations should deform a path by up to 2.5pt away from the original path.

This key set the  $\TeX$ -dimension `\pgfdecorationsegmentamplitude`.

`/pgf/decoration/meta-amplitude=<dimension>` (no default, initially 2.5pt)

This key determines the amplitude for a meta-decoration.

The key set the  $\TeX$ -macro (!) `\pgfmetadecorationsegmentamplitude`.

`/pgf/decoration/segment length=<dimension>` (no default, initially 10pt)

Many decorations are made up of small segments. This key determines the desired length of such segments.

This key set the  $\TeX$ -dimension `\pgfdecorationsegmentlength`.

`/pgf/decoration/meta-segment length=<dimension>` (no default, initially 1cm)

This determined the length of the meta-segments from which a meta-decoration is made up.

This key set the  $\TeX$ -macro (!) `\pgfmetadecorationsegmentlength`.

`/pgf/decoration/angle=<degree>` (no default, initially 45)

The way some decorations look like depends on a configurable angle. For instance, a `wave` decoration consists of arcs and the opening angle of these arcs is given by the `angle`.

This key set the  $\TeX$ -macro `\pgfdecorationsegmentangle`.

`/pgf/decoration/aspect=<factor>` (no default, initially 0.5)

For some decorations there is a natural aspect ratio. For instance, for a `brace` decoration the aspect ratio determines where the brace point will be.

This key set the  $\TeX$ -macro `\pgfdecorationsegmentaspect`.

`/pgf/decoration/start radius=<dimension>` (no default, initially 2.5pt)

For some decorations there is a natural start radius (of some circle, presumably).

This key stores the value directly inside the key.

`/pgf/decoration/end radius=<dimension>` (no default, initially 2.5pt)

For some decorations there is a natural radius (of some circle, presumably).

This key stores the value directly inside the key.

`/pgf/decoration/radius=<dimension>` (style, no default)

Sets the start and end radius simultaneously.

`/pgf/decoration/path has corners=<boolean>` (no default, initially false)

This is a hint to the decoration code as to whether the path has corners or not. If a path has a sharp corner, setting this option to `true` may result in better rendering of the decoration because the joins of input segments are approached “more carefully” than when this key is set to false. However, if the path is, say, a smooth circle, setting this key to `true` will usually look worse. Most decorations ignore this key, anyway. Internally, it sets the TeX-if `\ifpgfdecoratopathhascorners`.

## 29.2 Path Morphing Decorations

```
\usepgflibrary{decorations.pathmorphing} % TeX and plain TeX and pure pgf
\usepgflibrary[decorations.pathmorphing] % ConTeXt and pure pgf
\usetikzlibrary{decorations.pathmorphing} % TeX and plain TeX when using TikZ
\usetikzlibrary[decorations.pathmorphing] % ConTeXt when using TikZ
```

A *path morphing decoration* “morphs” or “deforms” the to-be-decorated path. This means that what used to be a straight line might afterwards be a snaking curve and have bumps. However, a line is still a line and path deforming decorations do not change the number of subpaths. For instance, if the path used to consist of two circles and an open arc, the path will after the decoration process still consist of two closed subpath and one open subpath.

### 29.2.1 Decorations Producing Straight Line Paths

The following deformations use only straight lines in order to morph the paths.

Decoration `lineto`

This decoration replaces the path by straight lines. For each curve, the path simply goes directly from the start point to the end point. In the following example, the arc actually consist of two subcurves.

This decoration is actually always defined when the decoration module is loaded, but it is documented here for consistency.

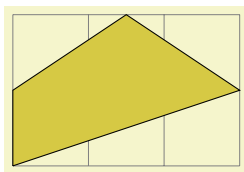

```
\begin{tikzpicture}[decoration=lineto]
\draw [help lines] grid (3,2);
\draw [decorate,fill=examplefill]
(0,0) -- (3,1) arc (0:180:1.5 and 1) -- cycle;
\end{tikzpicture}
```

Decoration `straight zigzag`

This (meta-)decoration decorates the path by alternating between `curveto` and `zigzag` decorations. It always finishes with the `curveto` decoration. The following parameters influence the decoration:

- `amplitude` determines how much the zig-zag lines raises above and falls below a straight line to the target point.
- `segment length` determines the length of a complete “up-down” cycle.
- `meta-segment length` determines the length of the `curveto` and the `zigzag` decorations.

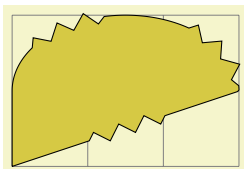

```
\begin{tikzpicture}[decoration={straight zigzag,meta-segment length=1.1cm}]
\draw [help lines] grid (3,2);
\draw [decorate,fill=examplefill]
(0,0) -- (3,1) arc (0:180:1.5 and 1) -- cycle;
\end{tikzpicture}
```

Decoration `random steps`

This decoration consists of straight line segments. The line segments head towards the target, but each step is randomly shifted a little bit. The following parameters influence the decorations:

- `segment length` determines the basic length of each step.
- `amplitude` The end of each step is perturbed both in  $x$ - and in  $y$ -direction by two values drawn uniformly from the interval  $[-d, d]$ , where  $d$  is the value of `amplitude`.

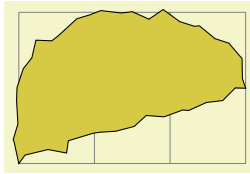

```
\begin{tikzpicture}
  [decoration={random steps,segment length=2mm}]
  \draw [help lines] grid (3,2);
  \draw [decorate,fill=examplefill]
    (0,0) -- (3,1) arc (0:180:1.5 and 1) -- cycle;
\end{tikzpicture}
```

### Decoration **saw**

This decoration looks like the blade of a saw. The following parameters influence the decoration:

- **amplitude** determines how much each spike raises above the straight line.
- **segment length** determines the length each spike.

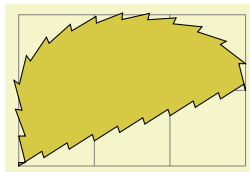

```
\begin{tikzpicture}[decoration=saw]
  \draw [help lines] grid (3,2);
  \draw [decorate,fill=examplefill]
    (0,0) -- (3,1) arc (0:180:1.5 and 1) -- cycle;
\end{tikzpicture}
```

### Decoration **zigzag**

This decoration looks like a zig-zag line. The following parameters influence the decoration:

- **amplitude** determines how much the zig-zag lines raises above and falls below a straight line to the target point.
- **segment length** determines the length of a complete “up-down” cycle.

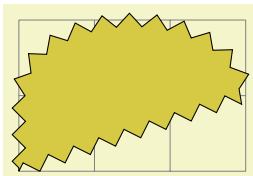

```
\begin{tikzpicture}[decoration=zigzag]
  \draw [help lines] grid (3,2);
  \draw [decorate,fill=examplefill]
    (0,0) -- (3,1) arc (0:180:1.5 and 1) -- cycle;
\end{tikzpicture}
```

## 29.2.2 Decorations Producing Curved Line Paths

### Decoration **bent**

This decoration adds a slightly bent line from the start to the target. The amplitude of the bent is given **amplitude** (an amplitude of zero gives a straight line).

- **amplitude** determines the amplitude of the bent.
- **aspect** determines how tight the bent is. A good value is around 0.3.

Note that this decoration makes only little sense for curves. You should apply it only to straight lines.

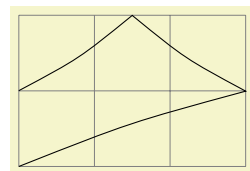

```
\begin{tikzpicture}[decoration=bent]
  \draw [help lines] grid (3,2);
  \draw [decorate] (0,0) -- (3,1) -- (1.5,2) -- (0,1);
\end{tikzpicture}
```

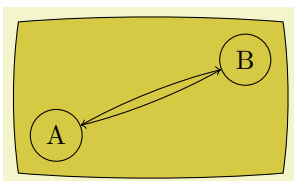

```
\begin{tikzpicture}[decoration={bent,aspect=.3}]
  \draw [decorate,fill=examplefill] (0,0) rectangle (3.5,2);
  \node[circle,draw] (A) at (.5,.5) {A};
  \node[circle,draw] (B) at (3,1.5) {B};
  \draw[->,decorate] (A) -- (B);
  \draw[->,decorate] (B) -- (A);
\end{tikzpicture}
```

### Decoration `bumps`

This decoration replaces the path by little half ellipses. The following parameters influence it

- `amplitude` determines the height of the half ellipse.
- `segment length` determines the width of the half ellipse.

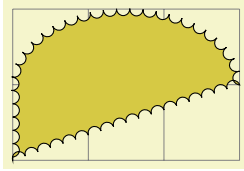

```
\begin{tikzpicture}[decoration=bumps]
\draw [help lines] grid (3,2);
\draw [decorate,fill=examplefill]
(0,0) -- (3,1) arc (0:180:1.5 and 1) -- cycle;
\end{tikzpicture}
```

### Decoration `coil`

This decoration replaces the path by a coiled line. To understand how this works, imagine a three-dimensional spring. The spring's axis points along the path toward the target. Then, we "view" the spring from a certain angle. If we look "straight from the side" we will see a perfect sine curve, if we look "more from the front" we will see a coil. The following parameters influence the decoration:

- `amplitude` determines how much the coil rises above the path and falls below it. Thus, this is the radius of the coil.
- `segment length` determines the distance between two consecutive "curls." Thus, when the spring is seen "from the side" this will be the wave length of the sine curve.
- `aspect` determines the "viewing direction." A value of 0 means "looking from the side" and a value of 0.5, which is the default, means "look more from the front."

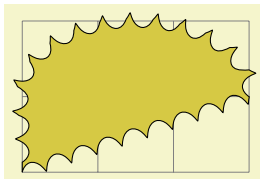

```
\begin{tikzpicture}[decoration=coil]
\draw [help lines] grid (3,2);
\draw [decorate,fill=examplefill]
(0,0) -- (3,1) arc (0:180:1.5 and 1) -- cycle;
\end{tikzpicture}
```

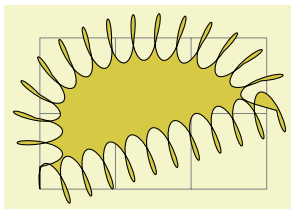

```
\begin{tikzpicture}
[decoration={coil,aspect=0.3,segment length=3mm,amplitude=3mm}]
\draw [help lines] grid (3,2);
\draw [decorate,fill=examplefill]
(0,0) -- (3,1) arc (0:180:1.5 and 1) -- cycle;
\end{tikzpicture}
```

### Decoration `curveto`

This decoration simply yields a line following the original path. This means that (ideally) it does not change the path and follows any curves in the path (hence the name). In reality, due to the internals of how decorations are implemented, this decoration actually replaces the path by numerous small straight lines.

This decoration is mostly useful in conjunction with meta-decorations. It is also actually defined in the decoration module and is always available.

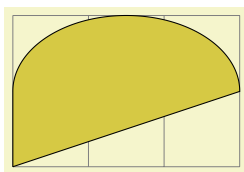

```
\begin{tikzpicture}[decoration=curveto]
\draw [help lines] grid (3,2);
\draw [decorate,fill=examplefill]
(0,0) -- (3,1) arc (0:180:1.5 and 1) -- cycle;
\end{tikzpicture}
```

### Decoration `snake`

This decoration replaces the path by a line that looks like a snake seen from above. More precisely, the snake is a sine wave with a "softened" start and ending. The following parameters influence the snake:

- `amplitude` determines the sine wave's amplitude.
- `segment length` determines the sine wave's wave length.

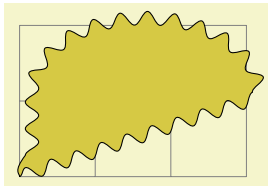

```
\begin{tikzpicture}[decoration=snake]
\draw [help lines] grid (3,2);
\draw [decorate,fill=examplefill]
(0,0) -- (3,1) arc (0:180:1.5 and 1) -- cycle;
\end{tikzpicture}
```

### 29.3 Path Replacing Decorations

```
\usepgflibrary{decorations.pathreplacing} %  $\TeX$  and plain  $\TeX$  and pure pgf
\usepgflibrary[decorations.pathreplacing] % Con $\TeX$ t and pure pgf
\usetikzlibrary{decorations.pathreplacing} %  $\TeX$  and plain  $\TeX$  when using TikZ
\usetikzlibrary[decorations.pathreplacing] % Con $\TeX$ t when using TikZ
```

This library defines decorations that replace the to-be-decorated path by another path. Unlike morphing decorations, the replaced path might be quite different, for instance a straight line might be replaced by a set of circles. Note that filling a path that has been replaced using one of the decorations in this library typically does not fill the original area but, rather, the smaller area of the newly-created path segments.

#### Decoration `border`

This decoration adds straight lines to the path that are at a specific angle to the line toward the target. The idea is to add these little lines to indicate the “border” or an area. The following parameters influence the decoration:

- `segment length` determines the distance between consecutive ticks.
- `amplitude` determines the length of the ticks.
- `angle` determines the angle between the ticks and the line of the path.

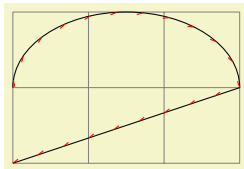

```
\begin{tikzpicture}[decoration=border]
\draw [help lines] grid (3,2);
\draw [postaction={decorate,draw,red}]
(0,0) -- (3,1) arc (0:180:1.5 and 1);
\end{tikzpicture}
```

#### Decoration `brace`

This decoration replaces a straight line path by a long brace. The left and right end of the brace will be exactly on the start and endpoint of the decoration. The decoration really only makes sense for paths that are a straight line.

- `amplitude` determines how much the brace rises above the path.
- `aspect` determines the fraction of the total length where the “middle part” of the brace will be.

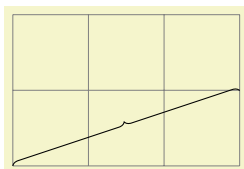

```
\begin{tikzpicture}[decoration=brace]
\draw [help lines] grid (3,2);
\draw [decorate] (0,0) -- (3,1);
\end{tikzpicture}
```

#### Decoration `expanding waves`

This decoration adds arcs to the path that get bigger along the line towards the target. The following parameters influence the decoration:

- `segment length` determines the distance between consecutive arcs.



- **angle** determines the opening angle below and above the path. Thus, the total opening angle is twice this angle.

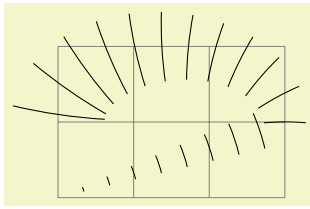

```
\begin{tikzpicture}[decoration={expanding waves,angle=5}]
\draw [help lines] grid (3,2);
\draw [decorate] (0,0) -- (3,1) arc (0:180:1.5 and 1);
\end{tikzpicture}
```

#### Decoration **moveto**

This decoration simply jumps to the end of the path using a move-to path operation. It is mainly useful as `pre=moveto` or `post=moveto` decorations.

This decoration is actually always defined when the decoration module is loaded, but it is documented here for consistency.

#### Decoration **ticks**

This decoration replaces the path by straight lines that are orthogonal to the path. The following parameters influence the decoration:

- **segment length** determines the distance between consecutive ticks.
- **amplitude** determines half the length of the ticks.

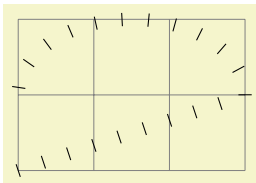

```
\begin{tikzpicture}[decoration=ticks]
\draw [help lines] grid (3,2);
\draw [decorate] (0,0) -- (3,1) arc (0:180:1.5 and 1);
\end{tikzpicture}
```

#### Decoration **waves**

This decoration replaces the path by arcs that have a constant size. The following parameters influence the decoration:

- **segment length** determines the distance between consecutive arcs.
- **angle** determines the opening angle below and above the path. Thus, the total opening angle is twice this angle.
- **radius** determines the radius of each arc.

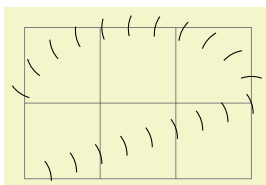

```
\begin{tikzpicture}[decoration={waves,radius=4mm}]
\draw [help lines] grid (3,2);
\draw [decorate] (0,0) -- (3,1) arc (0:180:1.5 and 1);
\end{tikzpicture}
```

#### Decoration **show path construction**

This decoration allows “something different” to be done for each *type* of input segment (i.e., `moveto`, `lineto`, `curveto` or `closepath`). Typically, each segment will be replaced with another path, but this need not necessarily be the case.

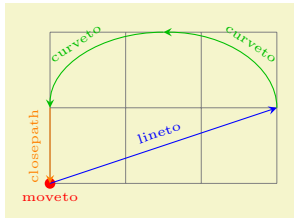

```

\begin{tikzpicture}[>stealth, every node/.style={midway, sloped, font=\tiny},
decoration={show path construction,
moveto code={
\fill [red] (\tikzinputsegmentfirst) circle (2pt)
node [fill=none, below] {moveto};},
lineto code={
\draw [blue,->] (\tikzinputsegmentfirst) -- (\tikzinputsegmentlast)
node [above] {lineto};
},
curveto code={
\draw [green!75!black,->] (\tikzinputsegmentfirst) .. controls
(\tikzinputsegmentsupporta) and (\tikzinputsegmentsupportb)
..(\tikzinputsegmentlast) node [above] {curveto};
},
closepath code={
\draw [orange,->] (\tikzinputsegmentfirst) -- (\tikzinputsegmentlast)
node [above] {closepath};}
}]
\draw [help lines] grid (3,2);
\path [decorate] (0,0) -- (3,1) arc (0:180:1.5 and 1) -- cycle;
\end{tikzpicture}

```

The following keys can be used to specify the code to execute for each type of input segment.

`/pgf/decoration/moveto code=<code>` (no default, initially `{}`)

Set the code to be executed for every `moveto` input segment. It is important to remember that the transformations applied by the decoration automaton are turned *off* when `<code>` is executed.

`/pgf/decoration/lineto code=<code>` (no default, initially `{}`)

Set the code to be executed for every `lineto` input segment.

`/pgf/decoration/curveto code=<code>` (no default, initially `{}`)

Set the code to be executed for every `curveto` input segment.

`/pgf/decoration/closepath code=<code>` (no default, initially `{}`)

Set the code to be executed for every `closepath` input segment.

Within `<code>` the first and last points on the current input segment can be accessed using `\pgfpointdecoratedinputsegmentfirst` and `\pgfpointdecoratedinputsegmentlast`. For curves, the control (support) points can be accessed using `\pgfpointdecoratedinputsegmentsupporta` and `\pgfpointdecoratedinputsegmentsupportb`.

In TikZ, you can use the following macros inside a TikZ coordinate.

`\tikzinputsegmentfirst`

The first point on the current input segment path.

`\tikzinputsegmentlast`

The last point on the current input segment path.

`\tikzinputsegmentsupporta`

The first support on the `curveto` input segment path.

`\tikzinputsegmentsupportb`

The second support on the `curveto` input segment path.

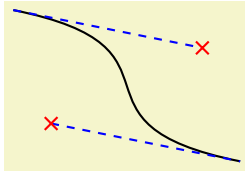

```

\tikzset{
  show curve controls/.style={
    decoration={
      show path construction,
      curveto code={
        \draw [blue, dashed]
          (\tikzinputsegmentfirst) -- (\tikzinputsegmentsupporta)
          node [at end, cross out, draw, solid, red, inner sep=2pt]{};
        \draw [blue, dashed]
          (\tikzinputsegmentsupportb) -- (\tikzinputsegmentlast)
          node [at start, cross out, draw, solid, red, inner sep=2pt]{};
      }
    },decoration
  }
}

\tikzpicture
  \draw [postaction=show curve controls, thick]
    (0,2) .. controls (2.5,1.5) and (0.5,0.5) .. (3,0);
\endtikzpicture

```

## 29.4 Marking Decorations

### 29.4.1 Overview

A *marking on a path* is any kind of graphic that is placed on a specific position on a path. Markings are useful in rather diverse situations: you can use them to, say, place little “footsteps” along a path as if someone were walking along the path; to place arrow tips on the middle of a path to indicate the “direction” in which something is flowing; or you can use them to place informative information at certain positions of a path.

For historical reasons there are three different libraries for placing marks on a path. They differ in what kind of markings can be added to a path. We start with the most general and most useful of these libraries.

## 29.5 Arbitrary Markings

```

\usepgflibrary{decorations.markings} %  $\LaTeX$  and plain  $\TeX$  and pure pgf
\usepgflibrary[decorations.markings] % Con $\TeX$ t and pure pgf
\usetikzlibrary{decorations.markings} %  $\LaTeX$  and plain  $\TeX$  when using TikZ
\usetikzlibrary[decorations.markings] % Con $\TeX$ t when using TikZ

```

Markings are arbitrary “marks” that can be put on a path. Marks can be arrow tips or nodes or even whole pictures.

### Decoration `markings`

A *marking* can be thought of a “little picture” or more precisely of “some scope contents” that is placed “on” a path at a certain position. Suppose the marking should be a simple cross. We can produce this with the following code:

```

\draw (-2pt,-2pt) -- (2pt,2pt);
\draw (2pt,-2pt) -- (-2pt,2pt);

```

If we use this code as a marking at position 2cm on a path, then the following happens: PGF determines the position on the path that is 2cm along the path. Then it translates the coordinate system to this position and rotates it such that the positive  $x$ -axis is tangent to the path. Then a protective scope is created, inside which the above code is executed – resulting in a little cross on the path.

The `markings` decoration allows you to place one or more such markings on a path. The decoration destroys the input path (except in certain cases, detailed later), which means that it uses the path for determining positions on the path, but after the decoration is done this path is gone. You typically need to use a `postaction` to add markings.

Let us start with the above example in real code:

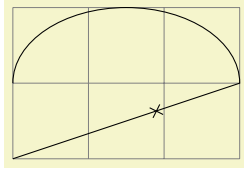

```
\begin{tikzpicture}[decoration={
  markings,% switch on markings
  mark=% actually add a mark
  at position 2cm
  with
  {
    \draw (-2pt,-2pt) -- (2pt,2pt);
    \draw (2pt,-2pt) -- (-2pt,2pt);
  }
}]
\draw [help lines] grid (3,2);
\draw [postaction={decorate}] (0,0) -- (3,1) arc (0:180:1.5 and 1);
\end{tikzpicture}
```

We can also add the cross repeatedly:

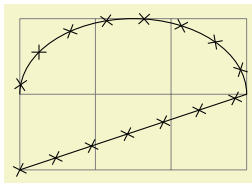

```
\begin{tikzpicture}[decoration={
  markings,% switch on markings
  mark=% actually add a mark
  between positions 0 and 1 step 5mm
  with
  {
    \draw (-2pt,-2pt) -- (2pt,2pt);
    \draw (2pt,-2pt) -- (-2pt,2pt);
  }
}]
\draw [help lines] grid (3,2);
\draw [postaction={decorate}] (0,0) -- (3,1) arc (0:180:1.5 and 1);
\end{tikzpicture}
```

The `mark` decoration option is used to specify a marking. It comes in two version:

`/pgf/decoration/mark=at position  $\langle pos \rangle$  with  $\langle code \rangle$`  (no default)

The options specifies that when a marking decoration is applied, there should be a marking at position  $\langle pos \rangle$  on the path whose code is given by  $\langle code \rangle$ .

The  $\langle pos \rangle$  can have four different forms:

1. It can be a non-negative dimension like `0pt` or `2cm` or `5cm/2`. In this case, it refers to the position along the path that is this far removed from the start.
2. It can be a negative dimension like `-1cm-2pt` or `-1sp`. In this case, the position is taken from the end of the path. Thus, `-1cm` is the position that is `-1cm` removed from the end of the path.
3. It can be a dimensionless non-negative number like `1/2` or `0.333+2*0.1`. In this case, the  $\langle pos \rangle$  is interpreted as a factor of the total path length. Thus, a  $\langle pos \rangle$  or `0.5` refers to the middle of the path, `0.1` is near the start, and so on.
4. It can be a dimensionless negative number like `-0.1`. Then, again, the fraction of the path length counts "from the end."

The  $\langle pos \rangle$  determines a position on the path. When the marking is applied, the (high level) coordinate system will have been transformed so that the origin lies at this position and the positive  $x$ -axis points along the path. For this coordinate system, the  $\langle code \rangle$  is executed. It can contains all sorts of graphic drawing commands, including (even named) nodes.

If the position position lies past the end of the path (for instance if  $\langle pos \rangle$  is set to `1.2`), the marking will not be drawn.

It is possible to give the `mark` option several times, which causes several markings to be applied. In this case, however, it is necessary that the positions on the path are in increasing order. That is, it is not allowed (and will result in chaos) to have a marking that lies earlier on the path to follow a marking that is later on the path.

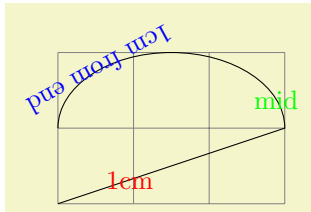

```
\begin{tikzpicture}[decoration={
  markings,% switch on markings
  mark=at position 1cm with \node[red]{1cm};,
  mark=at position .5 with \node[green]{mid};,
  mark=at position -1cm with {\node[blue,transform shape]{1cm from end};}]
\draw [help lines] grid (3,2);
\draw [postaction={decorate}] (0,0) -- (3,1) arc (0:180:1.5 and 1);
\end{tikzpicture}
```

Here is an example that shows how markings can be used to place text on plots:



```
\begin{tikzpicture}[domain=0:4,label/.style={postaction={
  decorate,
  decoration={
    markings,
    mark=at position .75 with \node #1;}}}]
\draw[very thin,color=gray] (-0.1,-1.1) grid (3.9,3.9);

\draw[>-] (-0.2,0) -- (4.2,0) node[right] {$x$};
\draw[>-] (0,-1.2) -- (0,4.2) node[above] {$f(x)$};

\draw[red,label={[above left]{$f(x)=x$}}] plot (\x,\x);
\draw[blue,label={[below left]{$f(x)=\sin x$}}] plot (\x,{\sin(\x r)});
\draw[orange,label={[right]{$f(x)=\frac{1}{20}\mathrm{e}^x$}}] plot (\x,{0.05*\exp(\x)});
\end{tikzpicture}
```

When the `<code>` is begin executed, two special keys will have been setup, whose value may be of interest:

`/pgf/decoration/mark info/sequence number` (no value)

This key can only be read. Its value (which can be obtained using the `\pgfkeysvalueof` command) is a “sequence number” of the mark. The first mark that is added to a path has number 1, the second number 2, and so on. This key is mainly useful in conjunction with repeated markings (see below).

`/pgf/decoration/mark info/distance from start` (no value)

This key can only be read. Its value is the distance of the marking from the start of the path in points. For instance, if the path length is 100pt and the marking is in the middle of the path, the value of this key would be 50.0pt.

A second way to use the `mark` key is the following:

`/pgf/decoration/mark=`between positions `<start pos>` and `<end pos>` step `<stepping>` with `<code>`(no default)

This works similarly to the `at position` versio of this option, only multiple marks are placed, starting at `<start pos>` and then spaced apart by `<stepping>`. The `<start pos>`, the `<end pos>`, and also the `<stepping>` may all be specified in the same way as for the `at position` version, that is, either using units or no units and also using positive or negative values.

Let us start with a simple example in which we place ten crosses along a path starting with the beginning of the path ( $\langle start\ pos \rangle = 0$ ) and ending at the end ( $\langle end\ pos \rangle = 1$ ).

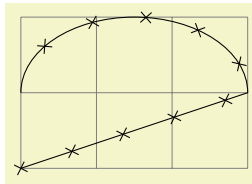

```
\begin{tikzpicture}[decoration={markings,
  mark=between positions 0 and 1 step 0.1
  with { \draw (-2pt,-2pt) -- (2pt,2pt);
        \draw (2pt,-2pt) -- (-2pt,2pt); } } ]
\draw [help lines] grid (3,2);
\draw [postaction={decorate}] (0,0) -- (3,1) arc (0:180:1.5 and 1);
\end{tikzpicture}
```

In the next example we place arrow shapes on the path instead of crosses. Note the use of the `transform shape` option to ensure that the nodes are actually rotated.

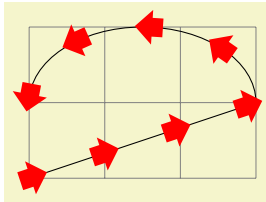

```
\begin{tikzpicture}[decoration={markings,
  mark=between positions 0 and 1 step 1cm
  with { \node [single arrow,fill=red,
              single arrow head extend=3pt,transform shape] {};}]}
\draw [help lines] grid (3,2);
\draw [postaction={decorate}] (0,0) -- (3,1) arc (0:180:1.5 and 1);
\end{tikzpicture}
```

Using the key `sequence number` we can also “number” the nodes and even refer to them later on.

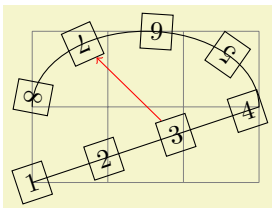

```
\begin{tikzpicture}[decoration={markings,
  mark=between positions 0 and 1 step 1cm with {
    \node [draw,
           name=mark-\pgfkeysvalueof{/pgf/decoration/mark info/sequence number},
           transform shape]
    {\pgfkeysvalueof{/pgf/decoration/mark info/sequence number}};}]
\draw [help lines] grid (3,2);
\draw [postaction={decorate}] (0,0) -- (3,1) arc (0:180:1.5 and 1);
\draw [red,->] (mark-3) -- (mark-7);
\end{tikzpicture}
```

In the following example we use the `distance info` to place “length information” on a path:

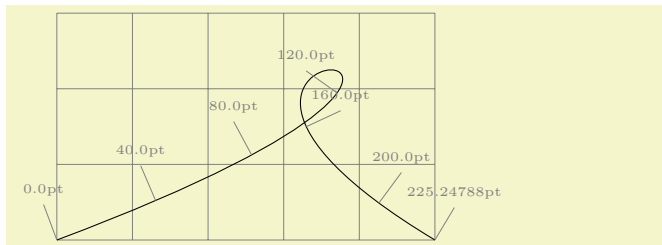

```
\begin{tikzpicture}[decoration={markings,
  % Main marks
  mark=between positions 0 and 1 step 40pt with
  { \draw [help lines] (0,0) -- (0,0.5)
    node[above,font=\tiny]{
      \pgfkeysvalueof{/pgf/decoration/mark info/distance from start}}; },
  mark=at position -0.1pt with
  { \draw [help lines] (0,0) -- (0,0.5)
    node[above,font=\tiny]{
      \pgfkeysvalueof{/pgf/decoration/mark info/distance from start}}; }]
\draw [help lines] grid (5,3);
\draw [postaction={decorate}] (0,0) .. controls (8,3) and (0,3) .. (5,0) ;
\end{tikzpicture}
```

### `/pgf/decoration/reset marks`

(no value)

Since `mark` options accumulate, there needs to be a way to “reset” things, so that any `mark` options set in an enclosing scope do not interfere. This option does exactly this. Note that when the `\code` of a marking is executed, the markings are automatically reset.

As mentioned earlier, the `decoration` usually destroys the path. However, this is no longer the case when the following key is set:

`/pgf/decoration/mark connection node=<node name>` (no default, initially empty)

When this key is set to a nonempty *<node name>* while the decoration is being processed, the following happens: The marking code should, among possibly other things, define node named *<node name>*. Then, the output path of this decoration will contain a line-to to “one end” of this node, followed by a moveto to the “other end” of the node. More precisely, the first end is given by the position on the border of *<node name>* that lies in the direction “from which the path heads toward the node” while the other end lies on the border “where the path heads away from the node.” Furthermore, this option causes the decoration to end with a line-to to the end instead of a move-to.

The net effect of all this is that when you decorate a straight line with one or more markings that contain just a node, the line will effectively connect these nodes.

Here are two examples that show how this works:

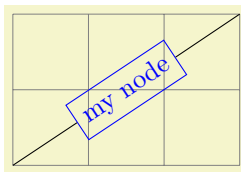

```
\begin{tikzpicture}[decoration={markings,
  mark connection node=my node,
  mark=at position .5 with
    {\node [draw,blue,transform shape] (my node) {my node};}}]
\draw [help lines] grid (3,2);
\draw decorate { (0,0) -- (3,2) };
\end{tikzpicture}
```

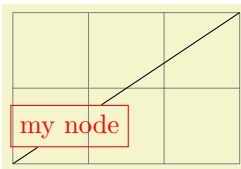

```
\begin{tikzpicture}[decoration={markings,
  mark connection node=my node,
  mark=at position .25 with
    {\node [draw,red] (my node) {my node};}}]
\draw [help lines] grid (3,2);
\draw decorate { (0,0) -- (3,2) };
\end{tikzpicture}
```

### 29.5.1 Arrow Tip Markings

Frequent markings that are hard to create correctly are arrow tips. For them, two special commands are available when the *<code>* of a `mark` option is executed. (They are only defined in this code):

`\arrow[<options>]{<arrow end tip>}`

This command simply draws the *<arrow end tip>* at the origin, pointing right. This is exactly what you need when you want to draw an arrow tip as a marking.

The *<options>* can only be given when TikZ is used. In this case, they are executed in a scope that contains the arrow tip.

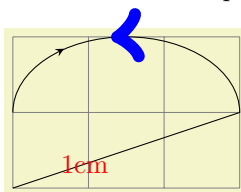

```
\begin{tikzpicture}[decoration={
  markings,% switch on markings
  mark=at position 1cm with {\node[red]{1cm};},
  mark=at position .75 with {\arrow[blue,line width=2mm]{>}},
  mark=at position -1cm with {\arrowreversed[black]{stealth};}}]
\draw [help lines] grid (3,2);
\draw [postaction={decorate}] (0,0) -- (3,1) arc (0:180:1.5 and 1);
\end{tikzpicture}
```

Here is a more useful example:

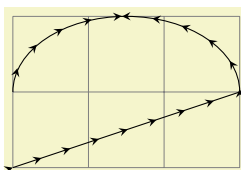

```
\begin{tikzpicture}[decoration={
  markings,% switch on markings
  mark=between positions 0 and .75 step 4mm with {\arrow{stealth}},
  mark=between positions .75 and 1 step 4mm with {\arrowreversed{stealth}}]
\draw [help lines] grid (3,2);
\draw [postaction={decorate}] (0,0) -- (3,1) arc (0:180:1.5 and 1);
\end{tikzpicture}
```

`\arrowreversed[<options>]{<arrow end tip>}`

As above, only the arrow end tip is flipped and points in the other direction.

## 29.5.2 Footprint Markings

```
\usepgflibrary{decorations.footprints} %  $\LaTeX$  and plain  $\TeX$  and pure pgf
\usepgflibrary[decorations.footprints] % Con $\TeX$ t and pure pgf
\usetikzlibrary{decorations.footprints} %  $\LaTeX$  and plain  $\TeX$  when using TikZ
\usetikzlibrary[decorations.footprints] % Con $\TeX$ t when using TikZ
```

The decorations of this library can be used to decorate a path with little footprints, as if someone had “walked” along the path.

### Decoration `footprints`

The footprint decoration adds little footprints around the path. They start with the left foot.

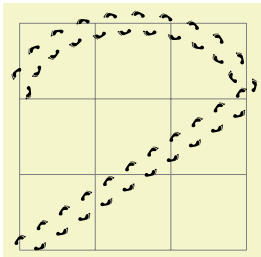

```
\begin{tikzpicture}[decoration={footprints,foot length=5pt,stride length=10pt}]
\draw [help lines] grid (3,3);
\fill [decorate] (0,0) -- (3,2) arc (0:180:1.5 and 1);
\end{tikzpicture}
```

You can influence the way this decoration looks using the following options:

`/pgf/decoration/foot length` (initially 10pt)

The length or size of the footprint itself. A larger value makes the footprint larger, but does not change the stride length.



```
\begin{tikzpicture}[decoration={footprints,foot length=20pt}]
\fill [decorate] (0,0) -- (3,0);
\end{tikzpicture}
```

`/pgf/decoration/stride length` (initially 30pt)

The length of strides. This is the distance between the beginnings of left footprints along the path.



```
\begin{tikzpicture}[decoration={footprints,stride length=50pt}]
\fill [decorate] (0,0) -- (3,0);
\end{tikzpicture}
```

`/pgf/decoration/foot sep` (initially 4pt)

The separation in the middle between the footprints. The footprints are moved away from the path by half this amount.



```
\begin{tikzpicture}[decoration={footprints,foot sep=10pt}]
\fill [decorate] (0,0) -- (3,0);
\end{tikzpicture}
```

`/pgf/decoration/foot angle` (initially 10)

Footprints are rotate by this much.



```
\begin{tikzpicture}[decoration={footprints,foot angle=60}]
\fill [decorate] (0,0) -- (3,0);
\end{tikzpicture}
```

`/pgf/decoration/foot of` (initially human)

The species whose footprints are shown. Possible values are:



| <i>Species</i>   | <i>Result</i> |
|------------------|---------------|
| gnome            |               |
| human            |               |
| bird             |               |
| felis silvestris |               |

### 29.5.3 Shape Background Markings

The third library for adding markings uses the background paths of certain shapes. This library is included mostly for historical reasons, using the `markings` library is usually preferable.

```
\usepgflibrary{decorations.shapes} %  $\TeX$  and plain  $\TeX$  and pure pgf
\usepgflibrary[decorations.shapes] % Con $\TeX$ t and pure pgf
\usetikzlibrary{decorations.shapes} %  $\TeX$  and plain  $\TeX$  when using TikZ
\usetikzlibrary[decorations.shapes] % Con $\TeX$ t when using TikZ
```

This library defines decorations that use shapes or shape-like drawings to decorate a path. The following options are common options used by the decorations in this library:

`/pgf/decoration/shape width=dimension` (no default, initially 2.5pt)

The desired width of the shapes. For decorations that support varying shape sizes, this key sets both the start and end width (which can be overwritten using options like `shape start width`).

`/pgf/decoration/shape height=dimension` (no default, initially 2.5pt)

Works like the previous key, only for the height.

`/pgf/decoration/shape size=dimension` (no default)

Sets the desired width and height simultaneously.

For the exact places and macros where these keys store the values, please consult the beginning of the code of the library.

#### Decoration `crosses`

This decoration replaces the path by (diagonal) crosses. The following parameters influence the decoration:

- `segment length` determines the distance between (the centers of) consecutive crosses.
- `shape height` determines the height of each cross.
- `shape width` determines the width of each cross.

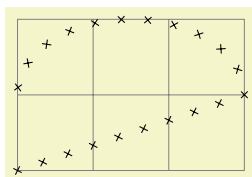

```
\begin{tikzpicture}[decoration=crosses]
\draw [help lines] grid (3,2);
\draw [decorate] (0,0) -- (3,1) arc (0:180:1.5 and 1);
\end{tikzpicture}
```

## Decoration `triangles`

This decoration replaces the path by triangles that point along the path. The following parameters influence the decoration:

- `segment length` determines the distance between consecutive triangles.
- `shape height` determines height of the triangle side that is orthogonal to the path.
- `shape width` determines the width of the triangle.

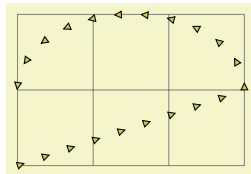

```
\begin{tikzpicture}[decoration=triangles]
\draw [help lines] grid (3,2);
\draw [decorate,fill=examplefill] (0,0) -- (3,1) arc (0:180:1.5 and 1);
\end{tikzpicture}
```

## Decoration `shape backgrounds`

This is a general decoration that replaces the to-be-decorated path by repeated copies of the background path of an arbitrary shape that has previously defined using the `\pgfdeclareshape` command (that is, you can use any shape in the shape libraries).

Please note that the background path of the shapes is used, but *no nodes are created*. This means that *you cannot have text inside the shapes of this path, you cannot name them, or refer to them*. Finally, this decoration *will not work with shapes that depend strongly of the size of the text box (like the arrow shapes)*. If any of these restrictions pose a problem, use the `markings` library instead.

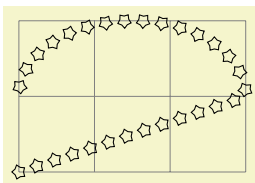

```
\begin{tikzpicture}[decoration={shape backgrounds,shape=star,shape size=5pt}]
\draw [help lines] grid (3,2);
\draw [decorate] (0,0) -- (3,1) arc (0:180:1.5 and 1);
\end{tikzpicture}
```

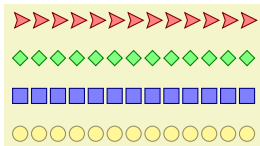

```
\tikzset{paint/.style={ draw=#1!50!black, fill=#1!50 },
decorate with/.style={
decorate,decoration={shape backgrounds,shape=#1,shape size=2mm}}}
\begin{tikzpicture}
\draw [decorate with=dart, paint=red] (0,1.5) -- (3,1.5);
\draw [decorate with=diamond, paint=green] (0,1) -- (3,1);
\draw [decorate with=rectangle, paint=blue] (0,0.5) -- (3,0.5);
\draw [decorate with=circle, paint=yellow] (0,0) -- (3,0);
\end{tikzpicture}
```

All shapes are positioned by the anchor that is specified via the `anchor` decoration option:

`/pgf/decoration/anchor=<anchor>` (no default, initially `center`)

The anchor used to position the shapes backgrounds.

A shape background path is added at the start point of the path and, if the distance between the shapes is appropriate, at the end point of the path.

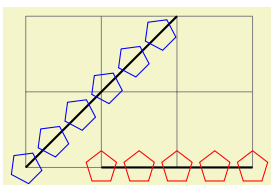

```
\begin{tikzpicture}[decoration={
shape backgrounds,shape=regular polygon,shape size=4mm}]
\draw [help lines] grid (3,2);
\draw [thick] (0,0) -- (2,2) (1,0) -- (3,0);
\draw [red, decorate, decoration={shape sep=.5cm}] (1,0) -- (3,0);
\draw [blue, decorate, decoration={shape sep=.5cm}] (0,0) -- (2,2);
\end{tikzpicture}
```

Keys for customizing specific shapes can be specified (e.g., `star points`, `cloud puffs`, `kite angles`, and so on). The size of the shape is “enforced” using transformations. This means that the shape is typeset with an empty text box and some default size values, resulting in an initial shape. This shape is then rescaled using coordinate transformations so that it has the desired size (which may vary as we

travel along the to-be-decorated path). This means that settings involving angles and distances may not appear entirely accurate. More general options such as `inner sep` and `minimum size` will be ignored, but transformations can be applied to each segment as described below.

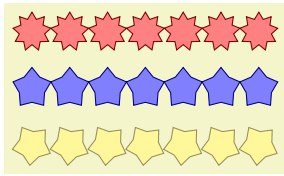

```
\tikzset{
  paint/.style={draw=#1!50!black, fill=#1!50},
  my star/.style={decorate,decoration={shape backgrounds,shape=star},
    star points=#1}
}
\begin{tikzpicture}[decoration={shape sep=.5cm, shape size=.5cm}]
  \draw [my star=9, paint=red] (0,1.5) -- (3,1.5);
  \draw [my star=5, paint=blue] (0,.75) -- (3,.75);
  \draw [my star=5, paint=yellow, shape border rotate=30] (0,0) -- (3,0);
\end{tikzpicture}
```

There are various keys to control the drawing of the shape decoration.

`/pgf/decoration/shape=shape name` (no default, initially `circle`)

The shape whose background path is used.

`/pgf/decoration/shape sep=spacing` (no default, initially `.25cm`, between centers)

Set the spacing between the shapes on the decoration path. This can be just a distance on its own, but the additional keywords `between centers`, and `between borders` (which must be preceded by a comma), specify that the distance is between the center anchors of the shapes or between the edges of the *boundaries* of the shape borders.

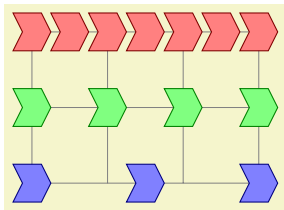

```
\begin{tikzpicture}[
  decoration={shape backgrounds,shape size=.5cm,shape=signal,
    signal from=west, signal to=east,
    paint/.style={decorate, draw=#1!50!black, fill=#1!50}}]
\draw [help lines] grid (3,2);
\draw [paint=red, decoration={shape sep=.5cm}]
  (0,2) -- (3,2);
\draw [paint=green, decoration={shape sep={1cm, between center}}]
  (0,1) -- (3,1);
\draw [paint=blue, decoration={shape sep={1cm, between borders}}]
  (0,0) -- (3,0);
\end{tikzpicture}
```

`/pgf/decoration/shape evenly spread=number` (no default)

This key overrides the `shape sep` key and forces the decoration to fit *number* shapes evenly across the path. If *number* is less than 1, then no shapes will be used. If *number* equals 1, then one shape is put in the middle of the path. The additional keywords `by centers` (the default, if no keyword is specified) and `by borders` can be used (both preceded by a comma), to specify how the distance between shapes is determined. These keywords will only have a noticeable effect if the shapes sizes differ over time.

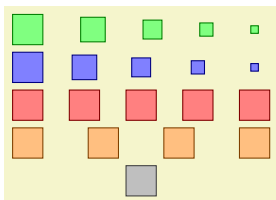

```
\tikzset{
  paint/.style={draw=#1!50!black, fill=#1!50},
  spreading/.style={
    decorate,decoration={shape backgrounds, shape=rectangle,
      shape start size=4mm,shape end size=1mm,shape evenly spread={#1}}
}
\begin{tikzpicture}
  \fill [paint=green,spreading={5, by borders},
    decoration={shape scaled}] (0,2) -- (3,2);
  \fill [paint=blue,spreading={5, by centers},
    decoration={shape scaled}] (0,1.5) -- (3,1.5);
  \fill [paint=red, spreading=5] (0,1) -- (3,1);
  \fill [paint=orange, spreading=4] (0,.5) -- (3,.5);
  \fill [paint=gray, spreading=1] (0,0) -- (3,0);
\end{tikzpicture}
```

`/pgf/decoration/shape sloped=boolean` (no default, initially `true`)

By default, shapes are rotated to the slope of the decoration path. If  $\langle boolean \rangle$  is the value `false`, then this rotation is turned off. Internally this sets the  $\TeX$ -if `\ifpgfshapedecorationsloped` appropriately.

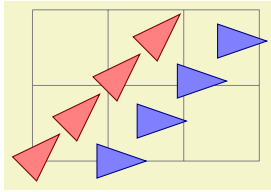

```
\tikzset{
  paint/.style={draw=#1!50!black, fill=#1!50}
}
\begin{tikzpicture}[decoration={
  shape width=.65cm, shape height=.45cm,
  shape=isosceles triangle, shape sep=.75cm,
  shape backgrounds}]
  \draw [help lines] grid (3,2);
  \draw [paint=red,decorate] (0,0) -- (2,2);
  \draw [paint=blue,decorate,decoration={shape sloped=false}]
      (1,0) -- (3,2);
\end{tikzpicture}
```

It is possible to scale the width and height of the shapes across the length of the decoration path. The shapes are scaled between the starting size and the ending size. The following keys customize the way the decoration shapes are scaled:

`/pgf/decoration/shape scaled= $\langle boolean \rangle$`  (no default, initially `false`)

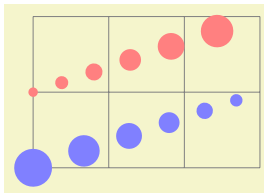

```
\tikzset{
  bigger/.style={decoration={shape start size=.125cm, shape end size=.5cm}},
  smaller/.style={decoration={shape start size=.5cm, shape end size=.125cm}},
  decoration={shape backgrounds,
    shape sep={.25cm, between borders},shape scaled}
}
\begin{tikzpicture}
  \draw [help lines] grid (3,2);
  \fill [decorate, bigger, red!50] (0,1) -- (3,2);
  \fill [decorate, smaller, blue!50] (0,0) -- (3,1);
\end{tikzpicture}
```

If this key is set to `false` (which is the default), then only the start width and height are used. Note that the keys `shape width` and `shape height` set the start and end height simultaneously.

`/pgf/decoration/shape start width= $\langle length \rangle$`  (no default, initially `2.5pt`)

The starting width of the shape.

`/pgf/decoration/shape start height= $\langle length \rangle$`  (no default, initially `2.5pt`)

The starting height of the shape.

`/pgf/decoration/shape start size= $\langle length \rangle$`  (style, no default)

Set both the the start height and start width simultaneously.

`/pgf/decoration/shape end width= $\langle length \rangle$`  (no default, initially `2.5pt`)

The recommended ending width of the shape. Note, that this is the width that a shape will take only if it is drawn exactly at the end of the path.

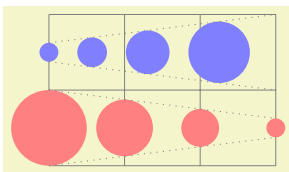

```
\tikzset{
  bigger/.style={decoration={shape start size=.25cm, shape end size=1cm}},
  smaller/.style={decoration={shape start size=1cm, shape end size=.25cm}},
  decoration={shape backgrounds,
    shape sep={.25cm, between borders},shape scaled}
}
\begin{tikzpicture}
  \draw [help lines] grid (3,2);
  \fill [decorate,bigger,
    decoration={shape sep={.25cm, between borders}}, blue!50]
    (0,1.5) -- (3,1.5);
  \fill [decorate,smaller,
    decoration={shape sep={1cm, between centers}}, red!50]
    (0,.5) -- (3,.5);
  \draw [gray, dotted] (0,1.625) -- (3,2) (0,1.375) -- (3,1)
    (0,1) -- (3,.625) (0,0) -- (3,.375);
\end{tikzpicture}
```

`/pgf/decoration/shape end height=<length>` (no default)

The recommended ending height of the shape.

`/pgf/decoration/shape end size=<length>` (style, no default)

Set both the the end height and end width simultaneously.

## 29.6 Text Decorations

```
\usepgflibrary{decorations.text} %  $\TeX$  and plain  $\TeX$  and pure pgf
\usepgflibrary[decorations.text] % Con $\TeX$ t and pure pgf
\usetikzlibrary{decorations.text} %  $\TeX$  and plain  $\TeX$  when using TikZ
\usetikzlibrary[decorations.text] % Con $\TeX$ t when using TikZ
```

The decoration in this library decorates the path with some text. This can be used to draw text that follows a curve.

### Decoration `text along path`

This decoration decorates the path with text. This drawing of the text is a “side effect” of the decoration. The to-be-decorated path is only used to determine where the characters should be put and it is thrown away after the decoration is done. This is why in the following example no line is shown.

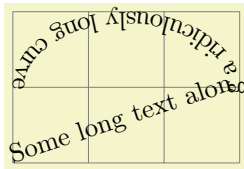

```
\catcode'\|12
\begin{tikzpicture}[decoration={text along path,
  text={Some long text along a ridiculously long curve that}}]
  \draw [help lines] grid (3,2);
  \draw [decorate] (0,0) -- (3,1) arc (0:180:1.5 and 1);
\end{tikzpicture}
```

PGF “does its best” to typeset the text, however you should note the following points:

- Each character in the text is typeset in a separate `\hbox`. This means that if you want fancy things like kerning or ligatures you will have to manually annotate the characters in the decoration text within a group, for example, `W{\kern-1ptA}TER`.
- Each character is positioned using the center of its baseline. To move the text vertically (relative to the path), the additional transform key should be used.
- No attempt is made to ensure characters do not overlap when the angle between segments is considerably less than  $180^\circ$  (this is tricky to do in  $\TeX$  without a huge processing overhead). In general this should not be too much of a problem, but, once again, kerning can be used in most cases to overcome any undesirable effects.
- It is only possible to typeset text in math mode under considerable restrictions. Math mode is entered and exited using any character of category code 3 (e.g., in plain  $\TeX$  this is `$`). Math subscripts and superscripts need to be contained within braces (e.g., `{ $\hat{y}_i$ }`) as do commands like `\times` or `\cdot`. However, even modestly complex mathematical typesetting is unlikely to be successful along a path (or even desirable).
- Some inaccuracies in positioning may be particularly apparent at input segment boundaries. This can (unfortunately) only be solved on case by case basis by individually kerning the offending characters within a group.

The following keys are used by the `text` decoration:

`/pgf/decoration/text=<text>` (no default, initially empty)

Set the text to typeset along the curve. Consecutive spaces are ignored, so `\` (or `\space` in  $\LaTeX$ ) should be used to insert multiple spaces. It is possible to format the text using normal formatting commands, such as `\it`, `\bf` and `\color`, within customisable delimiters. Initially these delimiters are both `|` (however, care will be needed regarding the category codes of delimiters — see below).



```
\catcode'\|12
\begin{tikzpicture}
  \draw [help lines] grid (3,2);
  \path [decorate,decoration={text along path,
    text={a big |\color{green}|green|| juicy apple.}}]
    (0,0) .. controls (0,2) and (3,0) .. (3,2);
\end{tikzpicture}
```

By following the first delimiter with +, the formatting commands are added to any existing formatting.



```
\begin{tikzpicture}
\draw [help lines] grid (3,2);
\path [decorate,decoration={text along path,
text={a \large|big |+\bf\color{red}|red|| juicy apple.}}]
(0,0) .. controls (0,2) and (3,0) .. (3,2);
\end{tikzpicture}
```

Internally, the text is stored in the macro `\pgfdecorationtext`. Any characters that have not been typeset when the end of the path has been reached will be stored in `\pgfdecorationrestoftext`.

`/pgf/decoration/text format delimiters={⟨before⟩}{⟨after⟩}` (no default, initially `{|}{|}`)

Set the characters that the text decoration will use to parse formatting commands. If `⟨after⟩` is empty, then `⟨before⟩` will be used for both delimiters. In general you should stick to characters whose category codes are 11 or 12. As + is used to indicate that the specified format commands are added to any existing ones, you should avoid using + as a delimiter.

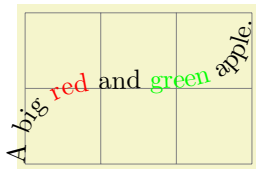

```
\begin{tikzpicture}
\draw [help lines] grid (3,2);
\path [decorate, decoration={text along path,text format delimiters={|}{|},
text={A big [\color{red}]red[] and [\color{green}]green[] apple.}}]
(0,0) .. controls (0,2) and (3,0) .. (3,2);
\end{tikzpicture}
```

`/pgf/decoration/text color=⟨color⟩` (no default, initially black)

The color of the text.

`/pgf/decoration/reverse path=⟨boolean⟩` (no default, initially false)

This key reverses the path. This is especially useful for typesetting text along different sides of curves.

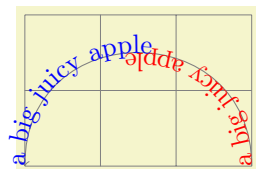

```
\begin{tikzpicture}
\draw [help lines] grid (3,2);
\draw [gray, ->]
[postaction={decoration={text along path,
text={a big juicy apple}, text color=red}, decorate}]
[postaction={decoration={text along path,
text={a big juicy apple}, text color=blue, reverse path}, decorate}]
(3,0) .. controls (3,2) and (0,2) .. (0,0);
\end{tikzpicture}
```

`/pgf/decoration/text align={⟨alignment options⟩}` (no default)

This changes the key path to `/pgf/decoration/text align` and executes `⟨alignment options⟩`.

`/pgf/decoration/text align/align=⟨alignment⟩` (no default, initially left)

Aligns the text according to `⟨alignment⟩`, which should be one of `left`, `right`, or `center`.

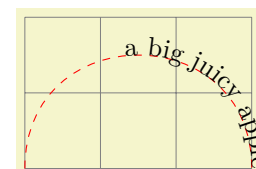

```
\begin{tikzpicture}
\draw [help lines] grid (3,2);
\draw [red, dashed]
[postaction={decoration={text along path, text={a big juicy apple},
text align={align=right}}, decorate}]
(0,0) .. controls (0,2) and (3,2) .. (3,0);
\end{tikzpicture}
```

`/pgf/decoration/text align/left` (style, no value)

Aligns the text to the left end of the path.

`/pgf/decoration/text align/right` (style, no value)

Aligns the text to the right end of the path.

`/pgf/decoration/text align/center` (style, no value)

Aligns the text to the center of the path.

`/pgf/decoration/text align/left indent=<length>` (no default, initially Opt)

Specify a distance which the automaton should move along before it starts typesetting the text.

`/pgf/decoration/text align/right indent=<length>` (no default, initially Opt)

Specify a distance before the end of the path, where the automaton should stop typesetting the text.

`/pgf/decoration/text align/fit to path=<boolean>` (no default, initially false)

This key makes the decoration automaton try to fit the text to the length of the path. The automaton shifts forward by a small amount between each character in order to fit the text to the path. If, however, the length of the text is longer than the length of the path (i.e., the automaton would have to shift *backwards* between characters) this key will have no effect.

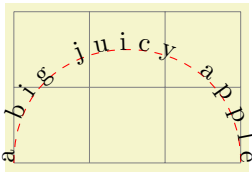

```
\begin{tikzpicture}
\draw [help lines] grid (3,2);
\draw [red, dashed]
[postaction={decoration={text along path, text={a big juicy apple},
text align=fit to path}, decorate}]
(0,0) .. controls (0,2) and (3,2) .. (3,0);
\end{tikzpicture}
```

`/pgf/decoration/text align/fit to path stretching spaces=<boolean>` (no default, initially false)

This key works like the previous key except the the automaton shifts forward only for space characters (including `\space`, but *excluding* `\` ).

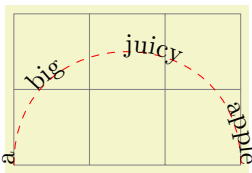

```
\begin{tikzpicture}
\draw [help lines] grid (3,2);
\draw [red, dashed]
[postaction={decoration={text along path, text={a big juicy apple},
text align={fit to path stretching spaces}}, decorate}]
(0,0) .. controls (0,2) and (3,2) .. (3,0);
\end{tikzpicture}
```

## 29.7 Fractal Decorations

```
\usepgflibrary{decorations.fractals} %  $\LaTeX$  and plain  $\TeX$  and pure pgf
\usepgflibrary[decorations.fractals] % Con $\TeX$ t and pure pgf
\usetikzlibrary{decorations.fractals} %  $\LaTeX$  and plain  $\TeX$  when using TikZ
\usetikzlibrary[decorations.fractals] % Con $\TeX$ t when using TikZ
```

The decorations of this library can be used to create fractal lines. To use them, you typically have to apply the decoration repeatedly to an originally straight path.

### Decoration `Koch curve type 1`

This decoration replaces a straight line by a “rectangular bump.” By repeatedly applying this replacement, different levels of the Koch curve fractal can be created. Its Hausdorff dimension is  $\log 5 / \log 3$ .

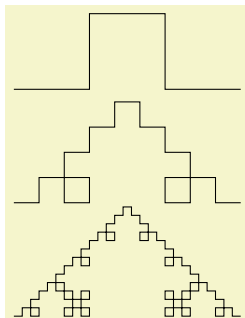

```
\begin{tikzpicture}[decoration=Koch curve type 1]
\draw decorate{ (0,0) -- (3,0) };
\draw decorate{ decorate{ (0,-1.5) -- (3,-1.5) } };
\draw decorate{ decorate{ decorate{ (0,-3) -- (3,-3) } } };
\end{tikzpicture}
```

### Decoration Koch curve type 2

This decoration replaces a straight line by a “rectangular sine.” Its Hausdorff dimension is  $3/2$ .

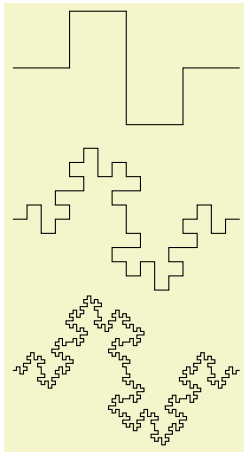

```
\begin{tikzpicture}[decoration=Koch curve type 2]
\draw decorate{ (0,0) -- (3,0) };
\draw decorate{ decorate{ (0,-2) -- (3,-2) } };
\draw decorate{ decorate{ decorate{ (0,-4) -- (3,-4) } } };
\end{tikzpicture}
```

### Decoration Koch snowflake

This decoration replaces a straight line by a “line with a spike.” Koch’s snowflake’s Hausdorff dimension is  $\log 4 / \log 3$ .

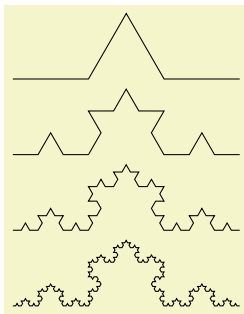

```
\begin{tikzpicture}[decoration=Koch snowflake]
\draw decorate{ (0,0) -- (3,0) };
\draw decorate{ decorate{ (0,-1) -- (3,-1) } };
\draw decorate{ decorate{ decorate{ (0,-2) -- (3,-2) } } };
\draw decorate{ decorate{ decorate{ decorate{ (0,-3) -- (3,-3) } } } };
\end{tikzpicture}
```

### Decoration Cantor set

This decoration replaces a straight line by a “line with a whole in the middle.” The Hausdorff dimension of the Cantor set is  $\log 2 / \log 3$ .

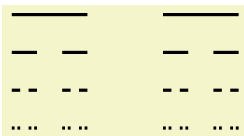

```
\begin{tikzpicture}[decoration=Cantor set,very thick]
\draw decorate{ (0,0) -- (3,0) };
\draw decorate{ decorate{ (0,-.5) -- (3,-.5) } };
\draw decorate{ decorate{ decorate{ (0,-1) -- (3,-1) } } };
\draw decorate{ decorate{ decorate{ decorate{ (0,-1.5) -- (3,-1.5) } } } };
\end{tikzpicture}
```



## 30 Entity-Relationship Diagram Drawing Library

```
\usetikzlibrary{er} %  $\TeX$  and plain  $\TeX$ 
\usetikzlibrary[er] % Con $\TeX$ t
```

This packages provides styles for drawing entity-relationship diagrams.

This library is intended to help you in creating E/R-diagrams. It defines only very little new styles, but using these style `entity` instead of saying `rectangle,draw` makes the code more expressive.

### 30.1 Entities

The package defines a simple style for drawing entities:

`/tikz/entity` (style, no value)

This style is to be used with nodes that represent entity types. It causes the node's shape to be set to a rectangle that is drawn and whose minimum size and width are set to sensible values.

Note that this style is called `entity` despite the fact that it is to be used for nodes representing entity *types* (the difference between an entity and an entity type is the same as the difference between an object and a class in object-oriented programming). If this bothers you, feel free to define a style `entity type` instead.



```
\begin{tikzpicture}
  \node[entity] (sheep)           {Sheep};
  \node[entity] (genome) [right=of sheep] {Genome};
\end{tikzpicture}
```

`/tikz/every entity` (style, no value)

This style is invoked by the style `entity`. To change the appearance of entities, you can change this style.



```
\begin{tikzpicture}
  [every entity/.style={draw=blue!50,fill=blue!20,thick}]
  \node[entity] (sheep)           {Sheep};
  \node[entity] (genome) [right=of sheep] {Genome};
\end{tikzpicture}
```

### 30.2 Relationships

Relationships are drawn using styles that are very similar to the styles for entities.

`/tikz/relationship` (style, no value)

This style works like `entity`, only it is to be used for relationships. Again, `relationships` are actually relationship types.

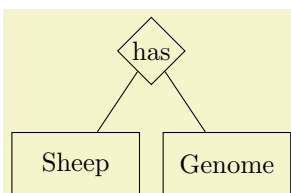

```
\begin{tikzpicture}
  \node[entity] (sheep) at (0,0) {Sheep};
  \node[entity] (genome) at (2,0) {Genome};
  \node[relationship] (has) at (1,1.5) {has}
    edge (sheep)
    edge (genome);
\end{tikzpicture}
```

`/tikz/every relationship`

(style, no value)

Works like every entity.

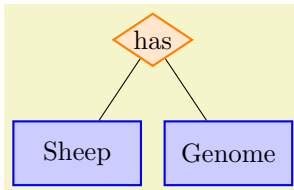

```
\begin{tikzpicture}
[every entity/.style={fill=blue!20,draw=blue,thick},
every relationship/.style={fill=orange!20,draw=orange,thick,aspect=1.5}]
\node[entity] (sheep) at (0,0) {Sheep};
\node[entity] (genome) at (2,0) {Genome};
\node[relationship] at (1,1.5) {has}
edge (sheep)
edge (genome);
\end{tikzpicture}
```

### 30.3 Attributes

`/tikz/attribute`

(style, no value)

This style is used to indicate that a node is an attribute. To connect an attribute to its entity, you can use, for example, the `child` command or the `pin` option.

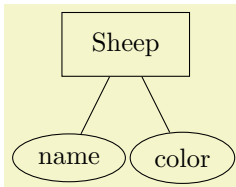

```
\begin{tikzpicture}
\node[entity] (sheep) {Sheep}
child {node[attribute] {name}}
child {node[attribute] {color}};
\end{tikzpicture}
```

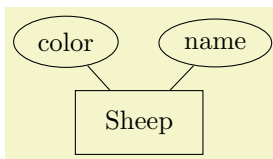

```
\begin{tikzpicture}[every pin edge/.style=draw]
\node[entity,pin={[attribute]60:name},pin={[attribute]120:color}] {Sheep};
\end{tikzpicture}
```

`/tikz/key attribute`

(style, no value)

This style is intended for key attributes. By default, it will cause the attribute to be typeset in italics. Typically, underlining is used instead, but that looks ugly and it is difficult to implement in  $\text{\TeX}$ .

`/tikz/every attribute`

(style, no value)

This style is used with every (key) attribute.

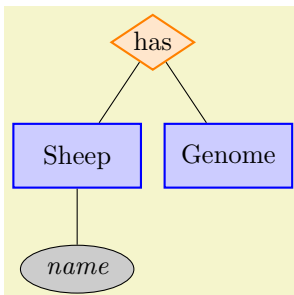

```
\begin{tikzpicture}
[text depth=1pt,
every attribute/.style={fill=black!20,draw=black},
every entity/.style={fill=blue!20,draw=blue,thick},
every relationship/.style={fill=orange!20,draw=orange,thick,aspect=1.5}]

\node[entity] (sheep) at (0,0) {Sheep}
child {node [key attribute] {name}};
\node[entity] (genome) at (2,0) {Genome};
\node[relationship] at (1,1.5) {has}
edge (sheep)
edge (genome);
\end{tikzpicture}
```

## 31 Externalization Library

by Christian Feuersänger

```
\usetikzlibrary{external} % LATEX and plain TEX
\usetikzlibrary[external] % ConTEXt
```

This library provides a high-level automatic or semi-automatic export feature for TikZ pictures. Its purpose is to convert each picture to a separate PDF.

### 31.1 Overview

There are several reasons why external images for at least some pictures are of interest:

1. Larger pictures require a considerable amount of time, which is necessary for every compilation. However, only few images will change from run to run. It can simply save time to export finished images and include them as final graphics.
2. It may be desirable to have final images for some graphics, for example to include them in third-party programs or to communicate them electronically.
3. It may be necessary to typeset a file in environments where PGF and TikZ are not available. In this case, external images are the only way to ensure compatibility.

The purpose of this library is to provide a way to export any TikZ-picture to separate PDF (or eps) images without changing the main document. It employs the `\beginpgfgraphicnamed ... \endpgfgraphicnamed` framework of PGF which is discussed in section 80.

### 31.2 Requirements

For most users, the library does not need special attention since requirements are met anyway. It collects all tokens between `\begin{tikzpicture}` and the next following `\end{tikzpicture}` and replaces them by the appropriate graphics or it takes steps to generate such an image.

It can't expand macros during this step, so the only requirement is that every picture's end is directly reachable from its beginning, without further macro expansion. Furthermore, the library assumes that all L<sup>A</sup>T<sub>E</sub>X pictures are ended with `\end{tikzpicture}`.

The library always searches for the *next* picture's end, `\end{tikzpicture}`. As a consequence, you can't use nested pictures directly. You *can* nest pictures, but you have to avoid that the nested picture's `\end` command is found before the outer `\end` command (for example using bracing constructs or by writing the nested picture into a separate macro call).

### 31.3 A word about ConT<sub>E</sub>Xt and plain T<sub>E</sub>X

Currently, the basic layer backend `\beginpgfgraphicnamed ... \endpgfgraphicnamed` relies on L<sup>A</sup>T<sub>E</sub>X only, so externalization is only supported for L<sup>A</sup>T<sub>E</sub>X yet.

### 31.4 Externalizing graphics

After loading the library, a call to `\tikzexternalize` is necessary to activate the externalization.

```

\documentclass{article}
% main document, called main.tex
\usepackage{tikz}

\usetikzlibrary{external}
\tikzexternalize{main} % provide the file's real name

\begin{document}
\begin{tikzpicture}
  \node {root}
  child {node {left}}
  child {node {right}}
  child {node {child}}
  child {node {child}}
};
\end{tikzpicture}

A simple image is \tikz \fill (0,0) circle(5pt);.
\end{document}

```

It is necessary to configure the file's name, in our case `main.tex`.

The method works as follows: if the document is typeset normally, the library searches for replacement images for every picture. Filenames are generated automatically if there is no explicit file name. In our case, the two file names will be `main-figure0` and `main-figure1`. If they exist, those images are simply included and the pictures as such are not processed. If graphics file do not exists, steps are taken to generate the missing ones. Missing images need to be generated by a separate run of  $\LaTeX$  in which the `\jobname` is set to the desired image file name.

```

pdflatex -jobname main-figure0 main
pdflatex -jobname main-figure1 main

```

In the default configuration `mode=convert with system call`, these commands are issued automatically by using the `\write18` method to call system commands. It is also possible to output every required file name; users will need to issue these command manually (or with a script). The probably most comfortable way is to use the default configuration with

```
pdflatex -shell-escape main
```

which automatically calls `pdflatex -jobname {<image>} {<main>}`.

If the library realizes that the jobname differs from the argument of `\tikzexternalize`, it enters its conversion mode. During the evaluation of

```
pdflatex -jobname main-figure0 main
```

PGF changes the shipout routine. The complete file `main.tex` is typeset as normal, but only the part of the desired picture will be written to the output file, in our case `main-figure0.pdf`. The rest of the document is silently thrown away. Of course, such a conversion process is quite expensive since we need to do it for every picture. Since everything except the current picture is thrown away, the library skips all other pictures. Furthermore, any `\includegraphics` commands which are outside of the converted TikZ-picture will be skipped as well. Thus, the conversion process should be much faster than typesetting the complete document, but it still requires its time.

Finally, all images will be converted. From this point on, successive runs of  $\LaTeX$  will use the final graphics files, the pictures won't be used anymore. Section 31.5 contains details about how to submit such a file to environments where PGF is not available.

`\tikzexternalize`{<optional arguments>}{<real file name>}

This command activates the externalization. It installs commands to replace every TikZ-picture. It needs to be called before `\begin{document}` because it may need to install its separate shipout routine.

The argument `{<real file name>}` denotes the file's name, without the `.tex` extension. It is used to generate picture filenames (by appending `-figure{<number>}`) and to decide whether a new shipout routine needs to be installed (if `\jobname` has a different value).

The `<optional argument>` can be any of the keys described below.

`/tikz/external/system call={<template>}` (no default)

A template string used to generate system calls. Inside of  $\{\langle template \rangle\}$ , the macro `\image` can be used as placeholder for the image which is about to be generated while `\texsource` contains the main file name.

The default is

```
\tikzset{external/system call={pdflatex -shell-escape -halt-on-error
-interaction=batchmode -jobname "\image" "\texsource"}}
```

For eps output, you can (and need to) use

```
\tikzset{external/system call={latex -shell-escape -halt-on-error
-interaction=batchmode -jobname "\image" "\texsource";
dvips -o "\image".ps "\image".dvi}}
```

The argument  $\{\langle template \rangle\}$  will be expanded using `\edef`, so any control sequences will be expanded. During this evaluation, `'\'` will result in a normal backslash, `'\'`. Furthermore, double quotes `"`, single quotes `'`, semicolons and dashes `-` will be made to normal characters if any package uses them as macros. This ensures compatibility with the `german` package, for example.

### 31.4.1 Customizing the Generated File Names

The default filename for externalized graphics is `'\langle real file name \rangle-figure- $\langle number \rangle$ '` where  $\langle number \rangle$  ranges from 0 to whatever is required. However, there are a couple of ways to change the generated filenames:

- Changing the overall file name using a `prefix`,
- Changing the file name for a single figure using `\tikzsetnextfilename`,
- Changing the file name for a restricted set of figures using `figure name`.

`/tikz/external/prefix={\langle file name prefix \rangle}` (no default, initially empty)

A shortcut for `\tikzsetexternalprefix{\langle file name prefix \rangle}`.

`\tikzsetexternalprefix{\langle file name prefix \rangle}`

Assigns a common prefix used by all file names. For example,

```
\tikzsetexternalprefix{figures/}
```

will prepend `figure/` to every external graphics file name.

Please note that `\tikzsetexternalprefix` is the *only* way to assign a prefix in case you want to prepare your document for environments where PGF is not installed (see section 31.5).

`\tikzsetnextfilename{\langle file name \rangle}`

Sets the file name for the *next* TikZ picture or `\tikz` short command. It will *only* be used for the next picture.

Pictures for which no explicit file name has been set will get automatically generated file names.

Please note that `prefix` will still be prepended to  $\{\langle file name \rangle\}$ .

```

\documentclass{article}
% main document, called main.tex
\usepackage{tikz}

\usetikzlibrary{external}
\tikzexternalize[prefix=figures/]{main} % provide the file's real name

\begin{document}

\tikzsetnextfilename{trees}
\begin{tikzpicture} % will be written to 'figures/trees.pdf'
  \node {root}
  child {node {left}}
  child {node {right}}
  child {node {child}}
  child {node {child}}
};
\end{tikzpicture}

\tikzsetnextfilename{simple}
A simple image is \tikz \fill (0,0) circle(5pt);. % will be written to 'figures/simple.pdf'

\begin{tikzpicture} % will be written to 'figures/main-figure0.pdf'
  \draw[help lines] (0,0) grid (5,5);
\end{tikzpicture}
\end{document}

```

```
pdflatex -shell-escape main
```

`/tikz/external/figure name={\langle name \rangle}` (no default)

Changes the names of all figures. It is possible to change `figure name` during the document using `\tikzset{external/figure name={\langle name \rangle}}`. A unique counter will be used for each different `{\langle name \rangle}`, and each counter will start at 0.

The value of `prefix` will be applied after `figure name` has been evaluated.

```

\documentclass{article}
% main document, called main.tex
\usepackage{tikz}

\usetikzlibrary{external}
\tikzexternalize{main} % provide the file's real name

\begin{document}

\begin{tikzpicture} % will be written to 'main-figure0.pdf'
  \node {root}
  child {node {left}}
  child {node {right}}
  child {node {child}}
  child {node {child}}
};
\end{tikzpicture}

{
  \tikzset{external/file name={subset_}}
  A simple image is \tikz \fill (0,0) circle(5pt);. % will be written to 'subset_0.pdf'

  \begin{tikzpicture} % will be written to 'subset_1.pdf'
    \draw[help lines] (0,0) grid (5,5);
  \end{tikzpicture}
}% here, the old file name will be restored:

\begin{tikzpicture} % will be written to 'main-figure1.pdf'
  \draw (0,0) -- (5,5);
\end{tikzpicture}
\end{document}

```

The scope of `file name` ends with the next closing brace (as all values set by `\tikzset` do).

Remark: Use `\tikzset{external/figure name/.add={\langle prefix_ \rangle}{\langle suffix_ \rangle}}` to add a `prefix_` and a `suffix_` to the actual value of `figure name`.

### 31.4.2 Remaking Figures or Skipping Figures

`/tikz/external/force remake={\boolean}` (default true)

A boolean which is used by `mode=convert` with `system call`. Every up-to-date check will fail, resulting in automatic regeneration of every figure.

```
\tikzset{external/force remake}
\begin{tikzpicture}
\draw (0,0) circle(5pt);
\end{tikzpicture}
```

You can also use `force remake` inside of a local  $\text{\TeX}$  group to remake only selected pictures. The example

```
\tikz \draw (0,0) -- (1,1);

{
\tikzset{external/force remake}
\begin{tikzpicture}
\draw (0,0) circle(5pt);
\end{tikzpicture}
}

\tikz \draw (0,0) -- (1,1);
```

will only apply `force remake` to the second figure.

`/tikz/external/remake next={\boolean}` (default true)

A variant of `force remake` which applies only to the next image.

`/tikz/external/export next={\boolean}` (default true)

A boolean which can be used to disable the export mechanism for single pictures.

`/tikz/external/export={\boolean}` (no default, initially true)

A boolean which can be used to disable the export mechanism for all pictures inside of the current  $\text{\TeX}$ -scope.

```
\begin{document}
\begin{tikzpicture} % will be exported
...
\end{tikzpicture}

{
\tikzset{external/export=false}
\begin{tikzpicture} % won't be exported
...
\end{tikzpicture}
...
}

\begin{tikzpicture} % will be exported
...
\end{tikzpicture}
\end{document}
```

For  $\text{\LaTeX}$ , the feature lasts until the next `\end{\cdot}` (this holds for every call to `\tikzset`).

### 31.4.3 Customizing the Externalization

`/tikz/external/figure list={\boolean}` (no default, initially true)

A boolean which configures whether a figure list shall be generated. A figure list is an output file named `{\jobname}.figlist` which is filled with file names of each figure, one per line.

This file is not used by  $\text{\TeX}$  anymore, its purpose is to issue the required conversion commands `pdflatex -jobname {\picture file name} {\main file}` manually (or in a script).

```

\documentclass{article}
% main document, called main.tex
\usepackage{tikz}

\usetikzlibrary{external}
\tikzexternalize[
  mode=graphics if exists,
  figure list=true,
  prefix=figures/]{main} % provide the file's real name

\begin{document}

\tikzsetnextfilename{trees}
\begin{tikzpicture}
  \node {root}
  child {node {left}}
  child {node {right}}
  child {node {child}}
  child {node {child}}
};
\end{tikzpicture}

\tikzsetnextfilename{simple}
A simple image is \tikz \fill (0,0) circle(5pt);.

\begin{tikzpicture}
  \draw[help lines] (0,0) grid (5,5);
\end{tikzpicture}
\end{document}

```

```
pdflatex main
```

generates `main.figlist` containing

```

figures/trees
figures/simple
figures/main-figure0

```

`/tikz/external/mode={\choice}` (no default, initially convert with system call)

Configures what to do with TikZ pictures.

The choice `only graphics` always tries to replace pictures with external graphics. It is an error if the graphics file does not exist.

The choice `no graphics` (or, equivalently, `only pictures`) typesets TikZ pictures without checking for external graphics.

A mixture is `graphics if exists`, it checks whether a suitable graphics file exists and includes it if that is the case. If it does not exist, the picture is typeset using  $\TeX$ .

Mode `list only` skips every TikZ picture; it only generates the file `{\main file}.figlist` containing file names for every picture. This implies `figure list=true`.

Finally, `convert with system call` checks whether external graphics file are up-to-date and includes them if that is the case. Any picture which is not up-to-date will be generated automatically using a system call. The system call can be configured using the `system call` template. The up-to-date check is simple: if the file does not exist, it is not up-to-date. Furthermore, if one of the `force remake` or `remake next` keys is true, the figure is not up-to-date. In all other case, the file is considered to be up-to-date. Setting this mode automatically disables `figure list` because such a file is not required. If you still need it, you can enable it after setting `mode`.

Please note that system calls may be disabled for security reasons. For `pdflatex`, they can be enabled using

```
pdflatex -shell-escape
```

while other  $\TeX$  variants may need other switches. The feature is sometimes called `\write18`.

`/tikz/external/verbose IO={\boolean}` (no default, initially true)

A boolean which configures whether I/O operations shall be listed in the logfile.



`/tikz/external/optimize={boolean}` (no default, initially true)

Configures whether the conversion process shall be optimized. This affects only the case when `\jobname` differs from the main file name, i.e. when single pictures are converted.

In that case, the main file is compiled as usual - but everything except the selected picture is thrown away. If optimization is enabled, all other pictures won't be processed at all. Furthermore, expensive commands which do not contribute to the selected picture will be thrown away as well.

The default implementation discards `\includegraphics` commands which are *not* inside of the selected picture to reduce conversion time.

It is possible to add commands which shall be optimized away, see below.

`/tikz/external/optimize command away= $\langle command \rangle$ {required argument count}` (no default)

Installs commands to optimize  $\langle command \rangle$  away. As is described above, optimization applies to the case when single pictures are converted: one usually doesn't need to process (probably expensive) commands which do not contribute to the selected picture.

The argument  $\{*required argument count*\}$  is either empty or a non-negative integer between 0 and 9. It denotes the number of arguments which should be consumed after  $\langle command \rangle$ . In any case, one argument in square brackets after the command will be recognised as well. To be more precise, the following cases for arguments of  $\langle command \rangle$  are supported:

1. If  $\{*required argument count*\}$  is empty (the default),  $\langle command \rangle$  may take one optional argument in square brackets and one in curly braces (which is also optional).
2. If  $\{*required argument count*\}$  is not empty,  $\{*required argument count*\}$  may take one optional argument in square brackets. Furthermore, it expects exactly  $\{*required argument count*\}$  following arguments.

Example:

```
\tikzset{external/optimize command away=\includegraphics}
```

```
\newcommand{\myExpensiveMacro}[1]{Very expensive!}
```

```
\tikzset{external/optimize command away=\myExpensiveMacro}
```

```
\newcommand{\myExpensiveMacroWithThreeArgs}[3]{Very expensive!}
```

```
\tikzset{external/optimize command away={\myExpensiveMacroWithThreeArgs}{3}}
```

```
% A command with optional argument:
```

```
\newcommand{\aFurtherExample}[3][ ]{Very expensive!}
```

```
% consume only two arguments: the first optional one will be processed
```

```
% anyway:
```

```
\tikzset{external/optimize command away={\myExpensiveMacroWithThreeArgs}{2}}
```

The argument  $\langle command \rangle$  must be the name of a single macro. Any occurrence of this macro, together with its arguments, will be removed.

```
\begin{tikzpicture}
```

```
% this picture is currently converted!
```

```
\end{tikzpicture}
```

```
This here is outside of the converted picture and contains \myExpensiveMacro. It will be discarded.
```

```
This call: \myExpensiveMacro[argument=value]{Argument} as well.
```

```
And this here: \myExpensiveMacro{Argument} also.
```

The default is to optimize `\includegraphics` away.

This key is actually a style which sets the `optimize/install` and `optimize/restore` keys.

`/tikz/external/optimize/install` (no value)

A command key which contains code to install optimizations. You can append code here (or clear the macro) if you need to modify the optimization.

`/tikz/external/optimize/restore` (no value)

A command key which contains code to undo optimizations. You can append code here (or clear the macro) if you need to modify the optimization.

`/tikz/external/only named={boolean}` (no default, initially false)

If enabled, only pictures for which file names have been set explicitly using `\tikzsetnextfilename` will be considered, no file names will be generated automatically.

`/pgf/images/include external` (initially `\pgfimage{#1}`)

This key constitutes the public interface to exchange the `\includegraphics` command used for the image inclusion.

Its description can be found in the corresponding basic layer documentation on page 645.

Just one example here: you can use

```
\pgfkeys{/pgf/images/include external/.code={\includegraphics[viewport=0 0 211.28 175.686]{#1}}}
```

to manually change the viewport (bounding box) for included graphics.

If you want to limit the effects of this key to just one externalized figure, use

```
{
\pgfkeys{/pgf/images/include external/.code={\includegraphics[viewport=0 0 211.28 175.686]{#1}}}
\begin{tikzpicture}
...
\end{tikzpicture}
}% this brace ends the effect of 'include external'
```

## 31.5 Using external graphics without PGF installed

Given that every picture has been exported correctly, one may want to compile a file without PGF and TikZ installed. TikZ comes with a minimal package which contains just enough commands to replace every `tikzpicture` environment and the `\tikz` short command with the appropriate external graphics. It can be found at

```
latex/pgf/utilities/tikzexternal.sty
```

and needs to be used instead of `\usepackage{tikz}`. Our example from the beginning thus becomes

```
\documentclass{article}
% main document, called main.tex
%\usepackage{tikz}

\usepackage{graphicx}
\usepackage{tikzexternal}

%\usetikzlibrary{external}
\tikzexternalize{main} % provide the file's real name

\begin{document}
\begin{tikzpicture}
  \node {root}
    child {node {left}}
    child {node {right}}
      child {node {child}}
      child {node {child}}
  };
\end{tikzpicture}

A simple image is \tikz \fill (0,0) circle(5pt);.
\end{document}
```

where the following files are necessary to compile the document:

```
tikzexternal.sty
main.tex
figures/main-figure0.pdf
figures/main-figure1.pdf
figures/main-figure2.pdf
```

If there are any ‘.dpth’ files, for example `figures/main-figure0.dpth`, these files are also required. They contain information for the TikZ `baseline` option.

Just copy the `.sty` file into the directory of your `main.tex` file and use it as part of your document.

Please keep in mind, that only `tikzpicture` environments and `\tikz` short images are available within the externalization framework. Additionally, calls to `\tikzset` and `\pgfkeys` won’t lead to compilation errors because they are simply ignored. But since `pgfkeys` is not available, any option supplied to `\tikzexternalize` is *ignored*.

Please use `\tikzsetexternalprefix` instead of the `prefix` option.

## 31.6 Externalization and bounding box restrictions

Bounding box restrictions provide no problem when used with `eps` graphics (see the next section). However, they pose problems for `pdflatex`, so you may need to use the `latex / dvips` combination if you use bounding box restrictions and externalization.

## 31.7 eps Graphics

It is also possible to use `eps` graphics instead of PDF files. There are different ways to produce them, for example to use `pdflatex` and call `pdftops -eps {<pdf file>} {<eps file>}` afterwards. You could add this command to the `system call` option.

Alternatively, you can use `latex` and `dvips` for image conversion as is explained for the `system call` option, see page 340. See the documentation for the basic level externalization in section 80 for restrictions of other drivers.

## 31.8 Interoperability with the basic layer externalization

This library is fully compatible with `\beginpgfgraphicnamed... \endpgfgraphicnamed` environments. However, you will need to use the `export next=false` key to avoid conflicts:









```
\beginpgfgraphicnamed{picture4}
\tikzset{external/export next=false}
\begin{tikzpicture}
  \draw (0,0) -- (4,4);
\end{tikzpicture}
\endpgfgraphicnamed
```

Please keep in mind that file prefixes do not apply to the basic layer.

## 32 Fading Library

```
\usepgflibrary{fadings} %  $\LaTeX$  and plain  $\TeX$  and pure pgf  
\usepgflibrary[fadings] % Con $\TeX$ t and pure pgf  
\usetikzlibrary{fadings} %  $\LaTeX$  and plain  $\TeX$  when using TikZ  
\usetikzlibrary[fadings] % Con $\TeX$ t when using TikZ
```

The package defines a number of fadings, see Section 20 for an introduction. The TikZ version defines special TikZ commands for creating fadings. These commands are explained in Section 20.

| <i>Fading name</i>                | <i>Example (solid blue faded on checkerboard)</i>                                   |
|-----------------------------------|-------------------------------------------------------------------------------------|
| west                              |    |
| east                              |    |
| north                             |    |
| south                             |    |
| circle with fuzzy edge 10 percent |    |
| circle with fuzzy edge 15 percent |   |
| circle with fuzzy edge 20 percent |  |
| fuzzy ring 15 percent             |  |

## 33 Fitting Library

`\usetikzlibrary{fit}` %  $\text{\LaTeX}$  and plain  $\text{\TeX}$

`\usetikzlibrary[fit]` %  $\text{ConTeXt}$

The library defines (currently only two) options for fitting a node so that it contains a set of coordinates.

When you load this library, the following options become available:

`/tikz/fit=<coordinates or nodes>` (no default)

This option must be given to a `node path` command. The `<coordinates or nodes>` should be a sequence of TikZ coordinates or node names, one directly after the other without commas (like with the `plot coordinates` path operation). Examples as `(1,0) (2,2)` or `(a) (1,0) (b)`, where `a` and `b` are nodes.

For this sequence of coordinates, a minimal bounding box is computed that encompasses all the listed `<coordinates or nodes>`. For coordinates in the list, the bounding box is guaranteed to contain this coordinate, for nodes it is guaranteed to contain the `east`, `west`, `north` and `south` anchors of the node. In principle (the details will be explained in a moment), things are now setup such that the text box of the node will be exactly this bounding box.

Here is an example: We fit several points in a rectangular node. By setting the `inner sep` to zero, we see exactly the text box of the node. Then we fit these points again in circular node. Note how the circle encompasses exactly the same bounding box.

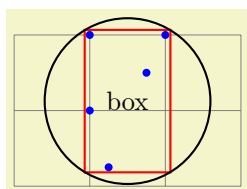

```
\begin{tikzpicture}[inner sep=0pt,thick,
                    dot/.style={fill=blue,circle,minimum size=3pt}]
  \draw[help lines] (0,0) grid (3,2);
  \node[dot] (a) at (1,1) {};
  \node[dot] (b) at (2,2) {};
  \node[dot] (c) at (1,2) {};
  \node[dot] (d) at (1.25,0.25) {};
  \node[dot] (e) at (1.75,1.5) {};

  \node[draw=red, fit=(a) (b) (c) (d) (e)] {box};
  \node[draw=black,circle,fit=(a) (b) (c) (d) (e)] {};
\end{tikzpicture}
```

Every time the `fit` option is used, the following style is also applied to the node:

`/tikz/every fit` (style, initially empty)

Set this style to change the appearance of a node that uses the `fit` option.

The exact effects of the `fit` option are the following:

1. A minimal bounding box containing all coordinates is computed. Note that if a coordinate like `(a)` is used that contains a node name, this has the same effect as explicitly providing the `(a.north)` and `(a.south)` and `(a.west)` and `(a.east)`. If you wish to refer only to the center of the `a` node, use `(a.center)` instead.
2. The `text width` option is set to the width of this bounding box.
3. The `align=center` option is set.
4. The `anchor` is set to `center`.
5. The `at` position of the node is set to the center of the computed bounding box.
6. After the node has been typeset, its height and depth are adjusted such that they add up to the height of the computed bounding box and such that the text of the node is vertically centered inside the box.

The above means that, generally speaking, if the node contains text like `box` in the above example, it will be centered inside the box. It will be difficult to put the text elsewhere, in particular, changing the `anchor` of the node will not have the desired effect. Instead, what you should do is to create a node with the `fit` option that does not contain any text, give it a name, and then use normal nodes to add text at the desired positions. Alternatively, consider using the `label` or `pin` options.

Suppose, for instance, that in the above example we want the word “box” to appear inside the box, but at its top. This can be achieved as follows:

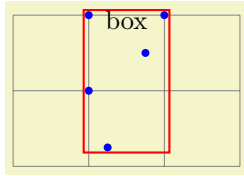

```

\begin{tikzpicture}[inner sep=0pt,thick,
                    dot/.style={fill=blue,circle,minimum size=3pt}]
\draw[help lines] (0,0) grid (3,2);
\node[dot] (a) at (1,1) {};
\node[dot] (b) at (2,2) {};
\node[dot] (c) at (1,2) {};
\node[dot] (d) at (1.25,0.25) {};
\node[dot] (e) at (1.75,1.5) {};

\node[draw=red,fit=(a) (b) (c) (d) (e)] (fit) {};
\node[below] at (fit.north) {box};
\end{tikzpicture}

```

Here is a real-life example that uses fitting:

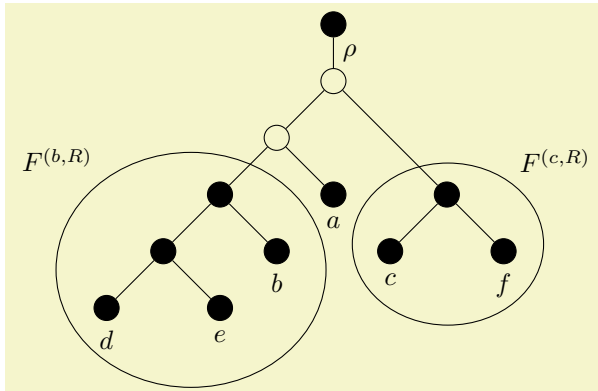

```

\begin{tikzpicture}
[vertex/.style={minimum size=2pt,fill,draw,circle},
open/.style={fill=none},
sibling distance=1.5cm,level distance=.75cm,
every fit/.style={ellipse,draw,inner sep=-2pt},
leaf/.style={label={[name=#1]below:$\#1$}},auto]

\node [vertex] (root) {}
child { node [vertex,open] {}
  child { node [vertex,open] {}
    child { node [vertex] (b's parent) {}
      child { node [vertex] {}
        child { node [vertex,leaf=d] {} }
        child { node [vertex,leaf=e] {} } }
      child { node [vertex,leaf=b] {} } }
    child { node [vertex,leaf=a] {} } }
  child { node [coordinate] {}
    child[missing]
    child { node [vertex] (f's parent) {}
      child { node [vertex,leaf=c] {} }
      child { node [vertex,leaf=f] {} } } } }
edge from parent node {\rho};

\node [fit=(d) (e) (b) (b's parent),label=above left:$F^{(b,R)}$] {};
\node [fit=(c) (f) (f's parent),label=above right:$F^{(c,R)}$] {};
\end{tikzpicture}

```

`/tikz/rotate fit= $\langle angle \rangle$`

(no default, initially 0)

This key fits  $\langle coordinates \text{ or } nodes \rangle$  inside a node that is rotated by  $\langle angle \rangle$ . As a side effect, it also sets the `/tikz/rotate` key.

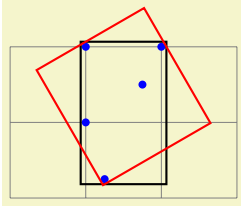

```
\begin{tikzpicture}[inner sep=0pt,thick,
dot/.style={fill=blue,circle,minimum size=3pt}]
\draw[help lines] (0,0) grid (3,2);
\node[dot] (a) at (1,1) {};
\node[dot] (b) at (2,2) {};
\node[dot] (c) at (1,2) {};
\node[dot] (d) at (1.25,0.25) {};
\node[dot] (e) at (1.75,1.5) {};
\node[draw, fit=(a) (b) (c) (d) (e)] {};
\node[draw=red, rotate fit=30, fit=(a) (b) (c) (d) (e)] {};
\end{tikzpicture}
```

## 34 Fixed Point Arithmetic Library

*This library is provisional, and may change/disappear without warning*

```
\usepgflibrary{fixedpointarithmetic} %  $\LaTeX$  and plain  $\TeX$  and pure pgf
\usepgflibrary[fixedpointarithmetic] % Con $\TeX$ t and pure pgf
\usetikzlibrary{fixedpointarithmetic} %  $\LaTeX$  and plain  $\TeX$  when using TikZ
\usetikzlibrary[fixedpointarithmetic] % Con $\TeX$ t when using TikZ
```

This library provides an interface to the  $\LaTeX$  package `fp` for fixed point arithmetic. In addition to loading this library you must ensure `fp` is loaded otherwise errors will occur.

### 34.1 Overview

Whilst the mathematical engine that comes with PGF is reasonably fast and flexible when it comes to parsing, the accuracy tends to be fairly low, particularly for expressions involving many operations chained together. In addition the range of values that can be computed is very small:  $\pm 16383.99999$ . Conversely, the `fp` package has a reasonably high accuracy, and can perform computations over a wide range of values (approximately  $\pm 9.999 \times 10^{17}$ ), but is comparatively slow and not very flexible, particularly regarding parsing.

This library enables the combination of the two: the flexible parser of the PGF mathematical engine with the evaluation accuracy of `fp`. There are, however, a number of important points to bear in mind:

- Whilst `fp` supports very large numbers, PGF and `TikZ` do not. It is possible to calculate the result of  $2^{20}$  or  $1.2e10+3.4e10$ , but it is not possible to use these results in pictures directly without some “extra work”.
- The PGF mathematical engine will still be used to evaluate lengths, such as `10pt` or `3em`, so it is not possible for an length to exceed the range of values supported by  $\TeX$ -dimensions ( $\pm 16383.99999pt$ ), even though the resulting expression is within the range of `fp`. So, for example, one can calculate `3cm*10000`, but not `3*10000cm`.
- Not all of the functions listed in Section 63, have been mapped onto `fp` equivalents. Of those that have been, it is not guaranteed that functions will perform in the same way as they do in PGF. Reference should be made to the documentation for `fp`.
- In PGF, trigonometric functions such as `sin` and `cos` assume arguments are in degrees, and functions such as `asin` and `acos` return results in degrees. Although `fp` uses radians for such functions, PGF automatically converts arguments from degrees to radians, and converts results from radians to degrees, to ensure everything “works properly”.
- The overall speed will actually be slower than using PGF mathematical engine. The calculating power of `fp` comes at the cost of an increased processing time.

### 34.2 Using Fixed Point Arithmetic in PGF and TikZ

The following key is provided to use `fp` in PGF and `TikZ`:

```
/pgf/fixed point arithmetic=<options> (no default)
alias /tikz/fixed point arithmetic
```

This key will set the key path to `/pgf/fixed point`, and execute `<options>`. Then it will install the necessary commands so that the PGF parser will use `fp` to perform calculations. The best way to use this key is as an argument to a scope or picture. This means that `fp` does not always have to be used, and PGF can use its own mathematical engine at other times, which can lead to a significant reduction in the time for a document to compile.

Currently there are only a few keys supported for `<options>`:

```
/pgf/fixed point/scale results=<factor> (no default)
```

As noted above, `fp` can process a far greater range of numbers than PGF and `TikZ`. In order to use results from `fp` in a `{pgfpicture}` or a `{tikzpicture}` they need to be scaled. When this key is used PGF will scale results of any evaluation by `<factor>`. However, as it is not desirable for every part of every expression to be scaled, scaling will only take place if a special prefix `*` is used. If `*` is used at



the beginning of an expression the evaluation of the expression will be evaluated and then multiplied by  $\langle factor \rangle$ .

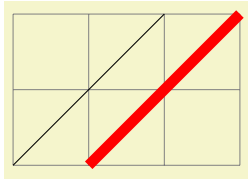

```
\begin{tikzpicture}[fixed point arithmetic={scale results=10^-6}]
\draw [help lines] grid (3,2);
\draw (0,0) -- (2,2);
\draw [red, line width=4pt] (*1.0e6,0) -- (*3.0e6,*2.0e6);
\end{tikzpicture}
```

A special case of scaling involves plots of data containing large numbers from files. It is possible to “pre-process” a file, typically using the application that generates the data, to either precede the relevant column with  $*$  or to perform the scaling as part of the calculation process. However, it may be desirable for the data in a plot to appear in a table as well, so, two files would be required, one pre-processed for plotting, and one not. This extra work may be undesirable so the following keys are provided:

`/pgf/fixed point/scale file plot x= $\langle factor \rangle$`  (no default)

This key will scale the first column of data read from a file before it is plotted. It is independent of the `scale results` key.

`/pgf/fixed point/scale file plot y= $\langle factor \rangle$`  (no default)

This key will scale the second column of data read from a file before it is plotted.

`/pgf/fixed point/scale file plot z= $\langle factor \rangle$`  (no default)

This key will scale the third column of data read from a file before it is plotted.

## 35 Floating Point Unit Library

by Christian Feuersänger

```
\usepgflibrary{fpu} %  $\TeX$  and plain  $\TeX$  and pure pgf
\usepgflibrary[fpu] % Con $\TeX$ t and pure pgf
\usetikzlibrary{fpu} %  $\TeX$  and plain  $\TeX$  when using TikZ
\usetikzlibrary[fpu] % Con $\TeX$ t when using TikZ
```

The floating point unit (fpu) allows the full data range of scientific computing for use in PGF. Its core is the PGF math routines for mantissa operations, leading to a reasonable trade-off between speed and accuracy. It does not require any third-party packages or external programs.

### 35.1 Overview

The fpu provides a replacement set of math commands which can be installed in isolated placed to achieve large data ranges at reasonable accuracy. It provides at least<sup>3</sup> the IEEE double precision data range,  $-1 \cdot 10^{324}, \dots, 1 \cdot 10^{324}$ . The absolute smallest number bigger than zero is  $1 \cdot 10^{-324}$ . The FPU's relative precision is at least  $1 \cdot 10^{-4}$  although operations like addition have a relative precision of  $1 \cdot 10^{-6}$ .

### 35.2 Usage

`/pgf/fpu={<boolean>}` (default true)

This key installs or uninstalls the FPU. The installation exchanges any routines of the standard math parser with those of the FPU: `\pgfmathadd` will be replaced with `\pgfmathfloatadd` and so on. Furthermore, any number will be parsed with `\pgfmathfloatparsenumber`.

```
1Y2.0e0] \pgfkeys{/pgf/fpu}
\pgfmathparse{1+1}\pgfmathresult
```

The FPU uses a lowlevel number representation consisting of flags, mantisse and exponent<sup>4</sup>. To avoid unnecessary format conversions, `\pgfmathresult` will usually contain such a cryptic number. Depending on the context, the result may need to be converted into something which is suitable for PGF processing (like coordinates) or may need to be typeset. The FPU provides such methods as well.

Use `fpu=false` to deactivate the FPU. This will restore any change. Please note that this is not necessary if the FPU is used inside of a  $\TeX$  group – it will be deactivated afterwards anyway.

It does not hurt to call `fpu=true` or `fpu=false` multiple times.

Please note that if the `fixed point arithmetics` library of PGF will be activated after the FPU, the FPU will be deactivated automatically.

`/pgf/fpu/output format=float|sci|fixed` (no default, initially float)

This key allows to change the number format in which the FPU assigns `\pgfmathresult`.

The predefined choice `float` uses the low-level format used by the FPU. This is useful for further processing inside of any library.

```
1Y2.17765411e23] \pgfkeys{/pgf/fpu,/pgf/fpu/output format=float}
\pgfmathparse{exp(50)*42}\pgfmathresult
```

The choice `sci` returns numbers in the format `<mantisse>e<exponent>`. It provides almost no computational overhead.

```
5.6154816e14] \pgfkeys{/pgf/fpu,/pgf/fpu/output format=sci}
\pgfmathparse{4.22e-8^-2}\pgfmathresult
```

The choice `fixed` returns normal fixed point numbers and provides the highest compatibility with the PGF engine. It is activated automatically in case the FPU scales results.

<sup>3</sup>To be more precise, the FPU's exponent is currently a 32 bit integer. That means it supports a significantly larger data range than an IEEE double precision number – but if a future  $\TeX$  version may provide lowlevel access to doubles, this may change.

<sup>4</sup>Users should *always* use high level routines to manipulate floating point numbers as the format may change in a future release.

0.000000999985

```
\pgfkeys{/pgf/fpu,/pgf/fpu/output format=fixed}
\pgfmathparse{sqrt(1e-12)}\pgfmathresult
```

`/pgf/fpu/scale results={\langle scale \rangle}` (no default)

A feature which allows semi-automatic result scaling. Setting this key has two effects: first, the output format for *any* computation will be set to `fixed` (assuming results will be processed by PGF's kernel). Second, any expression which starts with a star, `*`, will be multiplied with `{\langle scale \rangle}`.

`/pgf/fpu/scale file plot x={\langle scale \rangle}` (no default)

`/pgf/fpu/scale file plot y={\langle scale \rangle}` (no default)

`/pgf/fpu/scale file plot z={\langle scale \rangle}` (no default)

These keys will patch PGF's `plot file` command to automatically scale single coordinates by `{\langle scale \rangle}`.

The initial setting does not scale `plot file`.

`\pgflibraryfpuifactive{\langle true-code \rangle}{\langle false-code \rangle}`

This command can be used to execute dependent on whether the FPU has been activated or not.

### 35.3 Comparison to the fixed point arithmetics library

There are other ways to increase the data range and/or the precision of PGF's math parser. One of them is the `fp` package, preferable combined with PGF's `fixed point arithmetic` library. The differences between the FPU and `fp` are:

- The FPU supports at least the complete IEEE double precision number range, while `fp` covers only numbers of magnitude  $\pm 1 \cdot 10^{17}$ .
- The FPU has a uniform relative precision of about 4–5 correct digits. The fixed point library has an absolute precision which may perform good in many cases – but will fail at the ends of the data range (as every fixed point routines does).
- The FPU has potential to be faster than `fp` as it has access to fast mantisse operations using PGF's math capabilities (which use  $\text{\TeX}$  registers).

## 35.4 Command Reference and Programmer's Manual

### 35.4.1 Float-specific commands

`\pgfmathfloatparsenumber{\langle x \rangle}`

Reads a number of arbitrary magnitude and precision and stores its result into `\pgfmathresult` as floating point number  $m \cdot 10^e$  with mantisse and exponent base 10.

The algorithm and the storage format is purely text-based. The number is stored as a triple of flags, a positive mantisse and an exponent, such as

1Y2.0e0]

```
\pgfmathfloatparsenumber{2}
\pgfmathresult
```

Please do not rely on the low-level representation here, use `\pgfmathfloattomacro` (and its variants) and `\pgfmathfloatcreate` if you want to work with these components.

The flags encoded in `\pgfmathresult` are represented as a digit where '0' stands for the number  $\pm 0 \cdot 10^0$ , '1' stands for a positive sign, '2' means a negative sign, '3' stands for 'not a number', '4' means  $+\infty$  and '5' stands for  $-\infty$ .

The mantisse is a normalized real number  $m \in \mathbb{R}$ ,  $1 \leq m < 10$ . It always contains a period and at least one digit after the period. The exponent is an integer.

Examples:

Flags: 0; Mantisse 0.0; Exponent 0.

```
\pgfmathfloatparsenumber{0}
\pgfmathfloattomacro{\pgfmathresult}{\F}{\M}{\E}
Flags: \F; Mantisse \M; Exponent \E.
```

Flags: 1; Mantisse 2.0; Exponent -1.

```
\pgfmathfloatparsenumber{0.2}  
\pgfmathfloattomacro{\pgfmathresult}{\F}{\M}{\E}  
Flags: \F; Mantisse \M; Exponent \E.
```

Flags: 1; Mantisse 4.2; Exponent 1.

```
\pgfmathfloatparsenumber{42}  
\pgfmathfloattomacro{\pgfmathresult}{\F}{\M}{\E}  
Flags: \F; Mantisse \M; Exponent \E.
```

Flags: 1; Mantisse 2.05; Exponent 3.

```
\pgfmathfloatparsenumber{20.5E+2}  
\pgfmathfloattomacro{\pgfmathresult}{\F}{\M}{\E}  
Flags: \F; Mantisse \M; Exponent \E.
```

Flags: 1; Mantisse 1.0; Exponent 6.

```
\pgfmathfloatparsenumber{1e6}  
\pgfmathfloattomacro{\pgfmathresult}{\F}{\M}{\E}  
Flags: \F; Mantisse \M; Exponent \E.
```

Flags: 1; Mantisse 5.21513; Exponent -11.

```
\pgfmathfloatparsenumber{5.21513e-11}  
\pgfmathfloattomacro{\pgfmathresult}{\F}{\M}{\E}  
Flags: \F; Mantisse \M; Exponent \E.
```

The argument  $\langle x \rangle$  may be given in fixed point format or the scientific ‘e’ (or ‘E’) notation. The scientific notation does not necessarily need to be normalised. Its exponent should be limited to the range  $-16000 \leq e \leq +16000$  (the  $\text{T}_{\text{E}}\text{X}$ -integer range).

**/pgf/fpu/handlers/empty number**={ $\langle input \rangle$ }{ $\langle unreadable part \rangle$ } (no default)

This command key is invoked in case an empty string is parsed inside of `\pgfmathfloatparsenumber`. You can overwrite it to assign a replacement `\pgfmathresult` (in float!).

The initial setting is to invoke `invalid number`, see below.

**/pgf/fpu/handlers/invalid number**={ $\langle input \rangle$ }{ $\langle unreadable part \rangle$ } (no default)

This command key is invoked in case an invalid string is parsed inside of `\pgfmathfloatparsenumber`. You can overwrite it to assign a replacement `\pgfmathresult` (in float!).

The initial setting is to generate an error message.

**\pgfmathfloatqparsenumber**{ $\langle x \rangle$ }

The same as `\pgfmathfloatparsenumber`, but does not perform sanity checking.

**\pgfmathfloattofixed**{ $\langle x \rangle$ }

Converts a number in floating point representation to a fixed point number. It is a counterpart to `\pgfmathfloatparsenumber`. The algorithm is purely text based and defines `\pgfmathresult` as a string sequence which represents the floating point number  $\langle x \rangle$  as a fixed point number (of arbitrary precision).

Flags: 1; Mantisse 5.2; Exponent -4 $\rightarrow$ 0.00052

```
\pgfmathfloatparsenumber{0.00052}  
\pgfmathfloattomacro{\pgfmathresult}{\F}{\M}{\E}  
Flags: \F; Mantisse \M; Exponent \E  
$\to$\br/>\pgfmathfloattofixed{\pgfmathresult}  
\pgfmathresult
```

Flags: 1; Mantisse 1.23456; Exponent 6 $\rightarrow$ 1234560.00000000

```

\pgfmathfloatparsenumber{123.456e4}
\pgfmathfloattomacro{\pgfmathresult}{\F}{\M}{\E}
Flags: \F; Mantisse \M; Exponent \E
$\to$
\pgfmathfloattofixed{\pgfmathresult}
\pgfmathresult

```

**\pgfmathfloattosci**{*float*}

Converts a number from low-level floating point representation to scientific format,  $1.234e4$ .

**\pgfmathfloatcreate**{*flags*}{*mantisse*}{*exponent*}

Defines `\pgfmathresult` as the floating point number encoded by *flags*, *mantisse* and *exponent*.

All arguments are characters and will be expanded using `\edef`.

```
Flags: 1; Mantisse 1.0; Exponent 327
```

```

\pgfmathfloatcreate{1}{1.0}{327}
\pgfmathfloattomacro{\pgfmathresult}{\F}{\M}{\E}
Flags: \F; Mantisse \M; Exponent \E

```

**\pgfmathfloattomacro**{*x*}{*flagsmacro*}{*mantissemacro*}{*exponentmacro*}

Extracts the flags of a floating point number *x* to *flagsmacro*, the mantisse to *mantissemacro* and the exponent to *exponentmacro*.

**\pgfmathfloattoregisters**{*x*}{*flagscount*}{*mantissedimen*}{*exponentcount*}

Takes a floating point number *x* as input and writes flags to count register *flagscount*, mantisse to dimen register *mantissedimen* and exponent to count register *exponentcount*.

Please note that this method rounds the mantisse to  $\text{\TeX}$ -precision.

**\pgfmathfloattoregisterstok**{*x*}{*flagscount*}{*mantissetoks*}{*exponentcount*}

A variant of `\pgfmathfloattoregisters` which writes the mantisse into a token register. It maintains the full input precision.

**\pgfmathfloatgetflags**{*x*}{*flagscount*}

Extracts the flags of *x* into the count register *flagscount*.

**\pgfmathfloatgetmantisse**{*x*}{*mantissedimen*}

Extracts the mantisse of *x* into the dimen register *mantissedimen*.

**\pgfmathfloatgetmantissetok**{*x*}{*mantissetoks*}

Extracts the mantisse of *x* into the token register *mantissetoks*.

**\pgfmathfloatgetexponent**{*x*}{*exponentcount*}

Extracts the exponent of *x* into the count register *exponentcount*.

**\pgfmathfloatshift**{*x*}{*num*}

Defines `\pgfmathresult` to be  $x \cdot 10^{\text{num}}$ . The operation is an arithmetic shift base ten and modifies only the exponent of *x*. The argument *num* is expected to be a (positive or negative) integer.

**\pgfmathfloatabserror**{*x*}{*y*}

Defines `\pgfmathresult` to be the absolute error between two floating point numbers *x* and *y*,  $|x - y|$  and returns the result as floating point number.

**\pgfmathfloatrelerror**{*x*}{*y*}

Defines `\pgfmathresult` to be the relative error between two floating point numbers *x* and *y*,  $|x - y|/|y|$  and returns the result as floating point number.

### `\pgfmathfloattoextendedprecision{⟨x⟩}`

Renormalizes  $\{⟨x⟩\}$  to extended precision mantisse, meaning  $100 \leq m < 1000$  instead of  $1 \leq m < 10$ . The ‘extended precision’ means we have higher accuracy when we apply pgfmath operations to mantisses. The input argument is expected to be a normalized floating point number; the output argument is a non-normalized floating point number (well, normalized to extended precision). The operation is supposed to be very fast.

### `\pgfmathfloatint{⟨x⟩}`

Returns the integer part of the floating point number  $\{⟨x⟩\}$ , by truncating any digits after the period. This methods is applied to the absolute value  $|x|$ , so negative numbers are treated in the same way as positive ones. The result is returned as floating point number as well.

### `\pgfmathfloatsetextprecision{⟨shift⟩}`

Sets the precision used inside of `\pgfmathfloattoextendedprecision` to  $\{⟨shift⟩\}$ .

The different choices are

- |   |                  |      |                  |                                                             |
|---|------------------|------|------------------|-------------------------------------------------------------|
| 0 | normalization to | 0    | $\leq m < 1$     | (disable extended precision)                                |
| 1 | normalization to | 10   | $\leq m < 100$   |                                                             |
| 2 | normalization to | 100  | $\leq m < 1000$  | (default of <code>\pgfmathfloattoextendedprecision</code> ) |
| 3 | normalization to | 1000 | $\leq m < 10000$ |                                                             |

### `\pgfmathroundto{⟨x⟩}`

Rounds a fixed point number to prescribed precision and writes the result to `\pgfmathresult`.

The desired precision can be configured with `/pgf/number format/precision`, see section 66. This section does also contain application examples.

Any trailing zeros after the period are discarded. The algorithm is purely text based and allows to deal with precisions beyond  $\text{\TeX}$ ’s fixed point support.

As a side effect, the global boolean `\ifpgfmathfloatroundhasperiod` will be set to true if and only if the resulting mantisse has a period. Furthermore, `\ifpgfmathfloatroundmayneedrenormalize` will be set to true if and only if the rounding result’s floating point representation would have a larger exponent than  $\{⟨x⟩\}$ .

```
1 \pgfmathroundto{1}
  \pgfmathresult
```

```
4.69 \pgfmathroundto{4.685}
     \pgfmathresult
```

```
20000 \pgfmathroundto{19999.9996}
      \pgfmathresult
```

### `\pgfmathroundtozerofill{⟨x⟩}`

A variant of `\pgfmathroundto` which always uses a fixed number of digits behind the period. It fills missing digits with zeros.

```
1.00 \pgfmathroundtozerofill{1}
     \pgfmathresult
```

```
4.69 \pgfmathroundto{4.685}
     \pgfmathresult
```

```
20000.00 \pgfmathroundtozerofill{19999.9996}
        \pgfmathresult
```

### `\pgfmathfloatround{⟨x⟩}`

Rounds a normalized floating point number to a prescribed precision and writes the result to `\pgfmathresult`.

The desired precision can be configured with `/pgf/number format/precision`, see section 66.

This method employs `\pgfmathroundto` to round the mantisse and applies renormalizations if necessary.

As a side effect, the global boolean `\ifpgfmathfloatroundhasperiod` will be set to true if and only if the resulting mantisse has a period.

Flags: 1; Mantisse 5.26; Exponent 1.

```
\pgfmathfloatparsenumber{52.5864}
\pgfmathfloatround{\pgfmathresult}
\pgfmathfloattomacro{\pgfmathresult}{\F}{\M}{\E}
Flags: \F; Mantisse \M; Exponent \E.
```

Flags: 1; Mantisse 1; Exponent 1.

```
\pgfmathfloatparsenumber{9.995}
\pgfmathfloatround{\pgfmathresult}
\pgfmathfloattomacro{\pgfmathresult}{\F}{\M}{\E}
Flags: \F; Mantisse \M; Exponent \E.
```

### `\pgfmathfloatroundzerofill{⟨x⟩}`

A variant of `\pgfmathfloatround` produces always the same number of digits after the period (it includes zeros if necessary).

Flags: 1; Mantisse 5.26; Exponent 1.

```
\pgfmathfloatparsenumber{52.5864}
\pgfmathfloatroundzerofill{\pgfmathresult}
\pgfmathfloattomacro{\pgfmathresult}{\F}{\M}{\E}
Flags: \F; Mantisse \M; Exponent \E.
```

Flags: 1; Mantisse 1.00; Exponent 1.

```
\pgfmathfloatparsenumber{9.995}
\pgfmathfloatroundzerofill{\pgfmathresult}
\pgfmathfloattomacro{\pgfmathresult}{\F}{\M}{\E}
Flags: \F; Mantisse \M; Exponent \E.
```

### `\pgfmathlog{⟨x⟩}`

Defines `\pgfmathresult` to be the natural logarithm of `{⟨x⟩}`,  $\ln(\langle x \rangle)$ . This method is logically the same as `\pgfmathln`, but it applies floating point arithmetics to read number `{⟨x⟩}` and employs the logarithm identity

$$\ln(m \cdot 10^e) = \ln(m) + e \cdot \ln(10)$$

to get the result. The factor  $\ln(10)$  is a constant, so only  $\ln(m)$  with  $1 \leq m < 10$  needs to be computed. This is done using standard pgf math operations.

Please note that `{⟨x⟩}` needs to be a number, expression parsing is not possible here.

If `{⟨x⟩}` is *not* a bounded positive real number (for example  $\langle x \rangle \leq 0$ ), `\pgfmathresult` will be *empty*, no error message will be generated.

```
-15.7452 \pgfmathlog{1.452e-7}
\pgfmathresult
```

```
20.28096 \pgfmathlog{6.426e+8}
\pgfmathresult
```

### 35.4.2 Replacement commands

This sections describes some of the replacement commands in more details.

**`\pgfmathfloatlessthan`** $\langle x \rangle \langle y \rangle$

Defines `\pgfmathresult` as 1.0 if  $\langle x \rangle < \langle y \rangle$ , but 0.0 otherwise. It also sets the global `\TeX`-boolean `\pgfmathfloatcomparison` accordingly. The arguments  $\langle x \rangle$  and  $\langle y \rangle$  are expected to be numbers which have already been processed by `\pgfmathfloatparsenumber`. Arithmetics is carried out using `\TeX`-registers for exponent- and mantisse comparison.

**`\pgfmathfloatmax`** $\langle x \rangle \langle y \rangle$

Defines `\pgfmathresult` as the maximum of two floating point numbers  $\langle x \rangle$  and  $\langle y \rangle$ . The arguments  $\langle x \rangle$  and  $\langle y \rangle$  are expected to be numbers which have already been processed by `\pgfmathfloatparsenumber`. Arithmetics is carried out using `\TeX`-registers for exponent- and mantisse comparison.

**`\pgfmathfloatmin`** $\langle x \rangle \langle y \rangle$

Defines `\pgfmathresult` as the minimum of two floating point numbers  $\langle x \rangle$  and  $\langle y \rangle$ . The arguments  $\langle x \rangle$  and  $\langle y \rangle$  are expected to be numbers which have already been processed by `\pgfmathfloatparsenumber`. Arithmetics is carried out using `\TeX`-registers for exponent- and mantisse comparison.

**`\pgfmathfloatadd`** $\langle x \rangle \langle y \rangle$

Defines `\pgfmathresult` to be  $\langle x \rangle + \langle y \rangle$  for two floating point numbers, returning another floating point number.

It invokes the usual math engine on mantisses and employs 8 significant decimal digits for its computation (using `\pgfmathfloattoextendedprecision`).

**`\pgfmathfloatsubtract`** $\langle x \rangle \langle y \rangle$

Defines `\pgfmathresult` to be  $\langle x \rangle - \langle y \rangle$  for two floating point numbers, returning a floating point number.

It invokes the usual math engine on mantisses and employs 8 significant decimal digits for its computation (using `\pgfmathfloattoextendedprecision`).

**`\pgfmathfloatmultiply`** $\langle x \rangle \langle y \rangle$

Defines `\pgfmathresult` to be  $x \cdot y$  for two floating point numbers, returning a floating point number.

It invokes the usual math engine on mantisses.

**`\pgfmathfloatmultiplyfixed`** $\langle float \rangle \langle fixed \rangle$

Defines `\pgfmathresult` to be  $\langle float \rangle \cdot \langle fixed \rangle$  where  $\langle float \rangle$  is a floating point number and  $\langle fixed \rangle$  is a fixed point number. The computation is performed in floating point arithmetics, that means we compute  $m \cdot \langle fixed \rangle$  and renormalize the result where  $m$  is the mantisse of  $\langle float \rangle$ .

This operation renormalizes  $\langle float \rangle$  with `\pgfmathfloattoextendedprecision` before the operation, that means it is intended for relatively small arguments of  $\langle fixed \rangle$ . The result is a floating point number.

**`\pgfmathfloatdivide`** $\langle x \rangle \langle y \rangle$

Defines `\pgfmathresult` to be  $x/y$  for two floating point numbers, returning a floating point number.

It invokes the usual math engine on mantisses.

**`\pgfmathfloatsqrt`** $\langle x \rangle$

Defines `\pgfmathresult` to be  $\sqrt{x}$  for a floating point  $x$  and returns the result as floating point number.

It invokes the usual math engine on mantisses. It has a relative precision of about  $10^{-5}$ .

**`\pgfmathfloatabs`** $\langle x \rangle$

Defines `\pgfmathresult` to be  $|x|$  for a floating point number  $x$  and returns the result as floating point number.



### 35.4.3 Accessing the Original Math Routines for Programmers

As soon as the library is loaded, every private math routine will be copied to a new name. This allows library and package authors to access the T<sub>E</sub>X-register based math routines even if the FPU is activated. And, of course, it allows the FPU as such to perform its own mantissa computations.

Every (private) math command `\pgfmath<name>@` will be `\let` to the new name `\pgfmath@basic@<name>@` as soon as the library is loaded.

## 36 Lindenmayer System Drawing Library

### 36.1 Overview

Lindenmayer systems (also commonly known as “L-systems”), were originally developed by Aristid Lindenmayer as a theory of algae growth patterns and then subsequently used to model branching patterns in plants and produce fractal patterns. Typically, an L-system consists of a set of symbols, each of which is associated with some graphical action (such as “turn left” or “move forward”) and a set of rules (“production” or “rewrite” rules). Given a string of symbols, the rewrite rules are applied several times and the when resulting string is processed the action associated with each symbol is executed.

In PGF, L-systems can be used to create simple 2-dimensional fractal patterns...

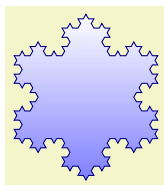

```
\begin{tikzpicture}
\pgfdeclarelindenmayersystem{Koch curve}{
  \rule{F -> F-F++F-F}
}
\shadedraw [top color=white, bottom color=blue!50, draw=blue!50!black]
  [l-system={Koch curve, step=2pt, angle=60, axiom=F++F++F, order=3}]
  lindenmayer system -- cycle;
\end{tikzpicture}
```

...and “plant like” patterns...

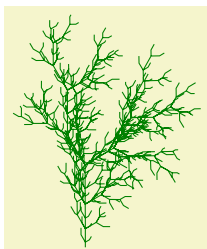

```
\begin{tikzpicture}
\draw [green!50!black, rotate=90]
  [l-system={rule set={F -> FF-[-F+F]+[+F-F]}, axiom=F, order=4, step=2pt,
    randomize step percent=25, angle=30, randomize angle percent=5}]
  lindenmayer system;
\end{tikzpicture}
```

...but it is important to bear in mind that even moderately complex L-systems can exceed the available memory of  $\text{T}_{\text{E}}\text{X}$ , and can be very slow. If possible, you are advised to increase the main memory and save stack to their maximum possible values for your particular  $\text{T}_{\text{E}}\text{X}$  distribution. However, even by doing this you may find you still run out of memory quite quickly.

For an excellent introduction to L-systems (containing some “really cool” pictures – many of which are sadly not possible in PGF) see *The Algorithmic Beauty of Plants* by Przemyslaw Prusinkiewicz and Aristid Lindenmayer (which is freely available via the internet).

```
\usepgflibrary{lindenmayersystems} %  $\text{T}_{\text{E}}\text{X}$  and plain  $\text{T}_{\text{E}}\text{X}$  and pure pgf
\usepgflibrary[lindenmayersystems] %  $\text{ConT}_{\text{E}}\text{Xt}$  and pure pgf
\usetikzlibrary{lindenmayersystems} %  $\text{T}_{\text{E}}\text{X}$  and plain  $\text{T}_{\text{E}}\text{X}$  when using TikZ
\usetikzlibrary[lindenmayersystems] %  $\text{ConT}_{\text{E}}\text{Xt}$  when using TikZ
```

This PGF-library provides basic commands for defining and using simple L-systems. The TikZ-library provides, furthermore, a front end for using L-systems in TikZ.

#### 36.1.1 Declaring L-systems

Before an L-system can be used, it must be declared using the following command:

```
\pgfdeclarelindenmayersystem{<name>}{<specification>}
```

This command declares a Lindenmayer system called  $\langle name \rangle$ . The  $\langle specification \rangle$  argument contains a description of the L-system’s symbols and rules. Two commands  $\backslash symbol$  and  $\backslash rule$  are only defined when the  $\langle specification \rangle$  argument is executed.

```
\symbol{<name>}{<code>}
```

This defines a symbol called  $\langle name \rangle$  for a specific L-system, and associates it with  $\langle code \rangle$ .

A symbol should consist of a single alpha-numeric character (i.e., A-Z, a-z or 0-9). The symbols F, f, +, -, [, and ] are available by default so do not need to be defined for each L-system. However, if you are feeling adventurous, they can be redefined for specific L-systems if required. The L-system treats the default symbols as follows (the commands they execute are described below):

- F move forward a certain distance, drawing a line. Uses `\pgflsystemdrawforward`.
- f move forward a certain distance, without drawing a line. Uses `\pgflsystemmoveforward`.
- + turn left by some angle. Uses `\pgflsystemturnleft`.
- - turn right by some angle. Uses `\pgflsystemturnright`.
- [ save the current state (i.e., the position and direction). Uses `\pgflsystemsavestate`.
- ] restore the last saved state. Uses `\pgflsystemrestorestate`.

The symbols [ and ] act like a stack: [ pushes the state of the L-system on to the stack, and ] pops a state off the stack.

When `<code>` is executed the transformation matrix is set up so that the origin is at the current position and the positive x-axis “points forward”, so `\pgfpathlineto{\pgfpoint{1cm}{0cm}}` draws a line 1cm forward.

The following keys can alter the production of an L-system. However, they do not store values in themselves.

`/pgf/lindenmayer system/step=<length>` (no default, initially 5pt)  
 How far the L-system moves forward if required. This key sets the TeX dimension `\pgflsystemstep`.

`/pgf/lindenmayer system/randomize step percent=<percentage>` (no default, initially 0)  
 If the step is to be randomized, this key specifies by how much. The value is stored in the TeX macro `\pgflsystemrandomizesteppercent`.

`/pgf/lindenmayer system/left angle=<angle>` (no default, initially 90)  
 This key sets the angle through which the L-system turns when it turns left. The value is stored in the TeX macro `\pgflsystemrleftangle`.

`/pgf/lindenmayer system/right angle=<angle>` (no default, initially 90)  
 This key sets the angle through which the L-system turns when it turns right. The value is stored in the TeX macro `\pgflsystemrrightangle`.

`/pgf/lindenmayer system/randomize angle percent=<percentage>` (no default, initially 0)  
 If the angles are to be randomized, this key specifies by how much. The value is stored in the TeX macro `\pgflsystemrandomizeanglepercent`.

For speed and convenience, when the code for a symbol is executed the following commands are available.

`\pgflsystemcurrentstep`

The current “step” of the L-system (i.e., how far the system will move forward if required). This is initially set to the value in the TeX-dimensions `\pgflsystemstep`, but the actual value may be changed if `\pgflsystemrandomizestep` is used (see below).

`\pgflsystemcurrentleftangle`

The angle the L-system will turn when it turns left. The value stored in this macro may be changed if `\pgflsystemrandomizeleftangle` is used.

`\pgflsystemcurrentrightangle`

The angle the L-system will turn when it turns right. The value stored in this macro may be changed if `\pgflsystemrandomizerightangle` is used.

The following commands may be useful if you wish to define your own symbols.

`\pgflsystemrandomizestep`

Randomizes the value in `\pgflsystemcurrentstep` according to the value of the `randomize step percent` key.

`\pgflsystemrandomizeleftangle`

Randomizes the value in `\pgflsystemcurrentleftangle` according to the value of the `randomize angle percent` key.

`\pgflsystemrandomizerightangle`

Randomizes the value in `\pgflsystemcurrentrightangle` according to the value of the `randomize angle` key.

### `\pgflsystemdrawforward`

Move forward in the current direction, by `\pgflsystemcurrentstep`, drawing a line in the process. This macro calls `\pgflsystemrandomizestep`. Internally, PGF simply shifts the transformation matrix in the positive direction of the current (transformed) x-axis by `\pgflsystemstep` and then executes a line-to to the (newly transformed) origin.

### `\pgflsystemmoveforward`

Move forward in the current direction, by `\pgflsystemcurrentstep`, without drawing a line. This macro calls `\pgflsystemrandomizestep`. PGF executes a transformation as above, but executes a move-to to the (newly transformed) origin.

### `\pgflsystemturnleft`

Turn left by `\pgflsystemcurrentleftangle`. Internally, PGF simply rotates the transformation matrix. This macro calls `\pgflsystemrandomizeleftangle`.

### `\pgflsystemturnright`

Turn right by `\pgflsystemcurrentrightangle`. Internally, PGF simply rotates the transformation matrix. This macro calls `\pgflsystemrandomizerightangle`.

### `\pgflsystemsavestate`

Save the current position and orientation. Internally, PGF simply starts a new  $\TeX$ -group.

### `\pgflsystemrestorestate`

Restore the last saved position and orientation. Internally, PGF closes a  $\TeX$ -group, restoring the transformation matrix of the outer scope, and a move-to command is executed to the (transformed) origin.

### `\rule{<head>-><body>}`

Declare a rule. *<head>* should consist of a single symbol, which need not have been declared using `\symbol` or exist as a default symbol (in fact, the more interesting L-systems depend on using symbols with no corresponding code, to control the “growth” of the system). *<body>* consists of a string of symbols, which again need not necessarily have any code associated with them.

As an example, the following shows an L-system that uses some of these commands. This example illustrates the point that some symbols, in this case A and B, do not have to have code associated with them. They simply control the growth of the system.

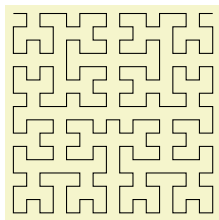

```
\pgfdeclarelindenmayersystem{Hilbert curve}{
  \symbol{X}{\pgflsystemdrawforward}
  \symbol{+}{\pgflsystemturnright} % Explicitly define + and - symbols.
  \symbol{-}{\pgflsystemturnleft}
  \rule{A -> +BX-AXA-XB+}
  \rule{B -> -AX+BXB+XA-}
}
\tikz\draw[lindenmayer system={Hilbert curve, axiom=A, order=4, angle=90}]
  lindenmayer system;
```

## 36.2 Using Lindenmayer Systems

### 36.2.1 Using L-Systems in PGF

The following command is used to run an L-system in PGF:

#### `\pgflindenmayersystem{<name>}{<axiom>}{<order>}`

Runs the L-system called *<name>* using the input string *<axiom>* for *<order>* iterations. In general, prior to calling this command the transformation matrix should be set appropriately for shifting and rotating, and a move-to to the (transformed) origin should be executed. This origin will be where the L-system starts. In addition the relevant keys should be set appropriately.

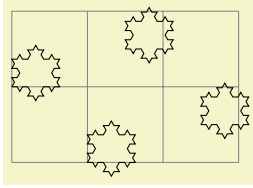

```

\begin{tikzpicture}
  \draw [help lines] grid (3,2);
  \pgfset{lindenmayer system/.cd, angle=60, step=2pt}
  \foreach \x/\y in {0cm/1cm, 1.5cm/1.5cm, 2.5cm/0.5cm, 1cm/0cm}{
    \pgftransformshift{\pgfpoint{\x}{\y}}
    \pgfpathmoveto{\pgfpointorigin}
    \pgflindenmayersystem{Koch curve}{F++F++F}{2}
    \pgfusepath{stroke}
  }
\end{tikzpicture}

```

Note that, it is perfectly feasible for an L-system to define special symbols which perform the move-to and use-path operations.

### 36.2.2 Using L-Systems in TikZ

In TikZ, an L-system is created using a path operation. However, TikZ is more flexible regarding the positioning of the L-system and also provides keys to create L-systems “on-line”.

```
\path ... lindenmayer system [keys] ... ;
```

This will run an L-system according to the parameters specified in *keys* (which can also contain normal keys such as `draw` or `thin`). The syntax is flexible regarding the L-system parameters and the following all do the same thing:

```
\draw lindenmayer system [lindenmayer system={Hilbert curve, axiom=4, order=3}];
```

```
\draw [lindenmayer system={Hilbert curve, axiom=4, order=3}] lindenmayer system;
```

```

\tikzset{lindenmayer system={Hilbert curve, axiom=4, order=3}}
\draw lindenmayer system;

```

```
\path ... l-system [keys] ... ;
```

A more compact version of the `lindenmayer system` path command.

This library adds some additional keys for specifying L-systems. These keys only work in TikZ and all have the same path, namely, `/pgf/lindenmayer system`, but so you do not have to keep repeating this path the following keys are provided:

```
/pgf/lindenmayer system={keys} (style, no default)
alias /tikz/lindenmayer system
```

This key changes the key path to `/pgf/lindenmayer systems` and executes *keys*.

```
/pgf/l-system={keys} (style, no default)
alias /tikz/l-system
```

A more compact version of the previous key.

```
/pgf/lindenmayer system/name={name} (no default)
Set the name for the L-system.
```

```
/pgf/lindenmayer system/axiom={string} (no default)
Set the axiom (or input string) for the L-system.
```

```
/pgf/lindenmayer system/order={integer} (no default)
Set the number of iterations the L-system will perform.
```

```
/pgf/lindenmayer system/rule set={list} (no default)
```

This key allows an (anonymous) L-system to be declared “on-line”. There is, however, a restriction that only the default symbols can be used for drawing (empty symbols can still be used to control the growth of the system). The rules in *list* should be separated by commas.

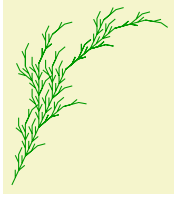

```
\tikz[rotate=65]\draw [green!60!black] l-system
[l-system={rule set={F -> F[+F]F[-F]}, axiom=F, order=4, angle=25,step=3pt}];
```

`/pgf/lindenmayer system/anchor=<anchor>` (no default)

By default, when this key is not used, the L-system will start from the last specified coordinate. By using this key, the L-system will be placed inside a special (rectangle) node which can be positioned using `<anchor>`.

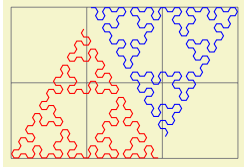

```
\begin{tikzpicture}[l-system={step=1.75pt, order=5, angle=60}]
\pgfdeclarelindenmayersystem{Sierpinski triangle}{
\symbol{X}{\pgflsystemdrawforward}
\symbol{Y}{\pgflsystemdrawforward}
\rule{X -> Y-X-Y}
\rule{Y -> X+Y+X}
}
\draw [help lines] grid (3,2);
\draw [red] (0,0) l-system
[l-system={Sierpinski triangle, axiom=+++X, anchor=south west}];
\draw [blue] (3,2) l-system
[l-system={Sierpinski triangle, axiom=X, anchor=north east}];
\end{tikzpicture}
```

## 37 Matrix Library

`\usetikzlibrary{matrix}` %  $\text{\TeX}$  and plain  $\text{\TeX}$

`\usetikzlibrary[matrix]` %  $\text{Con}\text{\TeX}$ t

This library packages defines additional styles and options for creating matrices.

### 37.1 Matrices of Nodes

A *matrix of nodes* is a TikZ matrix in which each cell contains a node. In this case it is bothersome having to write `\node{` at the beginning of each cell and `};` at the end of each cell. The following key simplifies typesetting such matrices.

`/tikz/matrix of nodes` (no value)

Conceptually, this key adds `\node{` at the beginning and `};` at the end of each cell and sets the **anchor** of the node to **base**. Furthermore, it adds the option **name** option to each node, where the name is set to `\langle matrix name \rangle-\langle row number \rangle-\langle column number \rangle`. For example, if the matrix has the name `my matrix`, then the node in the upper left cell will get the name `my matrix-1-1`.

|                                                                   |                                                                                                                                                                                                                               |
|-------------------------------------------------------------------|-------------------------------------------------------------------------------------------------------------------------------------------------------------------------------------------------------------------------------|
| $\begin{matrix} 8 & 1 & 6 \\ 3 & 5 & 7 \\ 4 & 9 & 2 \end{matrix}$ | <pre>\begin{tikzpicture}   \matrix (magic) [matrix of nodes]   {     8 &amp; 1 &amp; 6 \\     3 &amp; 5 &amp; 7 \\     4 &amp; 9 &amp; 2 \\   };   \draw[thick,red,-&gt;] (magic-1-1)  - (magic-2-3); \end{tikzpicture}</pre> |
|-------------------------------------------------------------------|-------------------------------------------------------------------------------------------------------------------------------------------------------------------------------------------------------------------------------|

You may wish to add options to certain nodes in the matrix. This can be achieved in three ways.

1. You can modify, say, the row 2 column 5 style to pass special options to this particular cell.

|                                                                   |                                                                                                                                                                                             |
|-------------------------------------------------------------------|---------------------------------------------------------------------------------------------------------------------------------------------------------------------------------------------|
| $\begin{matrix} 8 & 1 & 6 \\ 3 & 5 & 7 \\ 4 & 9 & 2 \end{matrix}$ | <pre>\begin{tikzpicture}[row 2 column 3/.style=red]   \matrix [matrix of nodes]   {     8 &amp; 1 &amp; 6 \\     3 &amp; 5 &amp; 7 \\     4 &amp; 9 &amp; 2 \\   }; \end{tikzpicture}</pre> |
|-------------------------------------------------------------------|---------------------------------------------------------------------------------------------------------------------------------------------------------------------------------------------|

2. At the beginning of a cell, you can use a special syntax. If a cell starts with a vertical bar, then everything between this bar and the next bar is passed on to the **node** command.

|                                                                   |                                                                                                                                                                                      |
|-------------------------------------------------------------------|--------------------------------------------------------------------------------------------------------------------------------------------------------------------------------------|
| $\begin{matrix} 8 & 1 & 6 \\ 3 & 5 & 7 \\ 4 & 9 & 2 \end{matrix}$ | <pre>\begin{tikzpicture}   \matrix [matrix of nodes]   {     8 &amp; 1 &amp; &amp; 6 \\     3 &amp; 5 &amp;  [red]  7 \\     4 &amp; 9 &amp; &amp; 2 \\   }; \end{tikzpicture}</pre> |
|-------------------------------------------------------------------|--------------------------------------------------------------------------------------------------------------------------------------------------------------------------------------|

You can also use an option like `|[red] (seven) |` to give a different name to the node.

Note that the `&` character also takes an optional argument, which is an extra column skip.

|                                                                               |                                                                                                                                                                                                                        |
|-------------------------------------------------------------------------------|------------------------------------------------------------------------------------------------------------------------------------------------------------------------------------------------------------------------|
| $\begin{matrix} 8 & & 1 & & 6 \\ 3 & & 5 & & 7 \\ 4 & & 9 & & 2 \end{matrix}$ | <pre>\begin{tikzpicture}   \matrix [matrix of nodes]   {     8 &amp;  [1cm] 1 &amp;  [3mm]  [red]  6 \\     3 &amp; &amp; 5 &amp; &amp;  [red]  7 \\     4 &amp; &amp; 9 &amp; &amp; 2 \\   }; \end{tikzpicture}</pre> |
|-------------------------------------------------------------------------------|------------------------------------------------------------------------------------------------------------------------------------------------------------------------------------------------------------------------|

3. If your cell starts with a `\path` command or any command that expands to `\path`, which includes `\draw`, `\node`, `\fill` and others, the `\node{` startup code and the `};` code are suppressed. This means that for this particular cell you can provide a totally different contents.

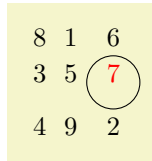

```
\begin{tikzpicture}
\matrix [matrix of nodes]
{
8 & 1 & 6 \\
3 & 5 & \node[red]{7}; \draw(0,0) circle(10pt);\\
4 & 9 & 2 \\
};
\end{tikzpicture}
```

`/tikz/matrix of math nodes`

(no value)

This style is almost the same as the previous style, only `$` is added at the beginning and at the end of each node, so math mode will be switched on in all nodes.

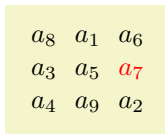

```
\begin{tikzpicture}
\matrix [matrix of math nodes]
{
a_8 & a_1 & a_6 \\
a_3 & a_5 & \color{red}a_7 \\
a_4 & a_9 & a_2 \\
};
\end{tikzpicture}
```

`/tikz/nodes in empty cells=(true or false)`

(default true)

When set to `true`, a node (with an empty contents) is put in empty cells. Normally, empty cells are just, well, empty. The style can be used together with both a matrix of nodes and a matrix of math nodes.

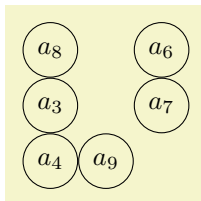

```
\begin{tikzpicture}
\matrix [matrix of math nodes,nodes={circle,draw}]
{
a_8 & & a_6 \\
a_3 & & a_7 \\
a_4 & a_9 & \\
};
\end{tikzpicture}
```

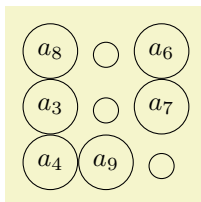

```
\begin{tikzpicture}
\matrix [matrix of math nodes,nodes={circle,draw},nodes in empty cells]
{
a_8 & & a_6 \\
a_3 & & a_7 \\
a_4 & a_9 & \\
};
\end{tikzpicture}
```

## 37.2 End-of-Lines and End-of-Row Characters in Matrices of Nodes

Special care must be taken about the usage of the `\\` command inside a matrix of nodes. The reason is that this character is overloaded in  $\text{\TeX}$ : On the one hand, it is used to denote the end of a line in normal text; on the other hand it is used to denote the end of a row in a matrix. Now, if a matrix contains node which in turn may have multiple lines, it is unclear which meaning of `\\` should be used.

This problem arises only when you use the `text width` option of nodes. Suppose you write a line like

```
\matrix [text width=5cm,matrix of nodes]
{
first row & upper line \\ lower line \\
second row & hmm \\
};
```

This leaves  $\text{\TeX}$  trying to riddle out how many rows this matrix should have. Do you want two rows with the upper right cell containing a two-line text. Or did you mean a three row matrix with the second row having only one cell?

Since  $\text{\TeX}$  is not clairvoyant, the following rules are used:



1. Inside a matrix, the `\` command, by default, signals the end of the row, not the end of a line in a cell.
2. However, there is an exception to this rule: If a cell starts with a  $\TeX$ -group (this is, with `{}`), then inside this first group the `\` command retains the meaning of “end of line” character. Note that this special rule works only for the first group in a cell and this group must be at the beginning.

The net effect of these rules is the following: Normally, `\` is an end-of-row indicator; if you want to use it as an end-of-line indicator in a cell, just put the whole cell in curly braces. The following example illustrates the difference:

|            |            |
|------------|------------|
| row 1      | upper line |
| lower line |            |
| row 2      | hmm        |

```
\begin{tikzpicture}
  \matrix [matrix of nodes,nodes={text width=16mm,draw}]
  {
    row 1 & upper line \\ lower line \\
    row 2 & hmm \\
  };
\end{tikzpicture}
```

|       |                          |
|-------|--------------------------|
| row 1 | upper line<br>lower line |
| row 2 | hmm                      |

```
\begin{tikzpicture}
  \matrix [matrix of nodes,nodes={text width=16mm,draw}]
  {
    row 1 & {upper line \\ lower line} \\
    row 2 & hmm \\
  };
\end{tikzpicture}
```

Note that this system is not fool-proof. If you write things like `a&b{c\\d}\\` in a matrix of nodes, an error will result (because the second cell did not start with a brace, so `\` retained its normal meaning and, thus, the second cell contained the text `b{c`, which is not balanced with respect to the number of braces).

### 37.3 Delimiters

Delimiters are parentheses or braces to the left and right of a formula or a matrix. The matrix library offers options for adding such delimiters to a matrix. However, delimiters can actually be added to any node that has the standard anchors `north`, `south`, `north west` and so on. In particular, you can add delimiters to any `rectangle` box. They are implemented by “measuring the height” of the node and then adding a delimiter of the correct size to the left or right using some after node magic.

`/tikz/left delimiter=<delimiter>` (no default)

This option can be given to a any node that has the standard anchors `north`, `south` and so on. The `<delimiter>` can be any delimiter that is acceptable to  $\TeX$ 's `\left` command.

|                                                                                                       |                                                                                                                                                                                                                             |
|-------------------------------------------------------------------------------------------------------|-----------------------------------------------------------------------------------------------------------------------------------------------------------------------------------------------------------------------------|
| $\left( \begin{array}{ccc} a_8 & a_1 & a_6 \\ a_3 & a_5 & a_7 \\ a_4 & a_9 & a_2 \end{array} \right)$ | <pre>\begin{tikzpicture}   \matrix [matrix of math nodes,left delimiter=(,right delimiter=\}]   {     a_8 &amp; a_1 &amp; a_6 \\     a_3 &amp; a_5 &amp; a_7 \\     a_4 &amp; a_9 &amp; a_2 \\   }; \end{tikzpicture}</pre> |
|-------------------------------------------------------------------------------------------------------|-----------------------------------------------------------------------------------------------------------------------------------------------------------------------------------------------------------------------------|

|                                   |                                                                                                                                                   |
|-----------------------------------|---------------------------------------------------------------------------------------------------------------------------------------------------|
| $\left( \int_0^1 x \, dx \right)$ | <pre>\begin{tikzpicture}   \node [fill=red!20,left delimiter=(,right delimiter=\}]   {\${\displaystyle\int_0^1 x\,dx}\$}; \end{tikzpicture}</pre> |
|-----------------------------------|---------------------------------------------------------------------------------------------------------------------------------------------------|

`/tikz/every delimiter` (style, initially empty)

This style is executed for every delimiter. You can use it to shift or color delimiters or do whatever.

`/tikz/every left delimiter` (style, initially empty)

This style is additionally executed for every left delimiter.

$$\begin{pmatrix} a_8 & a_1 & a_6 \\ a_3 & a_5 & a_7 \\ a_4 & a_9 & a_2 \end{pmatrix}$$

```
\begin{tikzpicture}
  [every left delimiter/.style={red,xshift=1ex},
  every right delimiter/.style={xshift=-1ex}]
  \matrix [matrix of math nodes,left delimiter=(,right delimiter=\}]
  {
    a_8 & a_1 & a_6 \\
    a_3 & a_5 & a_7 \\
    a_4 & a_9 & a_2 \\
  };
\end{tikzpicture}
```

`/tikz/right delimiter=<delimiter>` (no default)

Works as above.

`/tikz/every right delimiter` (style, initially empty)

Works as above.

`/tikz/above delimiter=<delimiter>` (no default)

This option allows you to add a delimiter above the node. It is implementing by rotating a left delimiter.

$$\left\{ \begin{array}{ccc} a_8 & a_1 & a_6 \\ a_3 & a_5 & a_7 \\ a_4 & a_9 & a_2 \end{array} \right.$$

```
\begin{tikzpicture}
  \matrix [matrix of math nodes,%
  left delimiter=|,right delimiter=\rmoustache,%
  above delimiter=(,below delimiter=)]
  {
    a_8 & a_1 & a_6 \\
    a_3 & a_5 & a_7 \\
    a_4 & a_9 & a_2 \\
  };
\end{tikzpicture}
```

`/tikz/every above delimiter` (style, initially empty)

Works as above.

`/tikz/below delimiter=<delimiter>` (no default)

Works as above.

`/tikz/every below delimiter` (style, initially empty)

Works as above.

## 38 Mindmap Drawing Library

```
\usetikzlibrary{mindmap} %  $\LaTeX$  and plain  $\TeX$   
\usetikzlibrary[mindmap] % Con $\TeX$ t
```

This packages provides styles for drawing mindmap diagrams.

### 38.1 Overview

This library is intended to make the creation of mindmaps or concept maps easier. A *mindmap* is a graphical representation of a concept together with related concepts and annotations. Mindmaps are, essentially, trees, possibly with a few extra edges added, but they are usually drawn in a special way: The root concept is placed in the middle of the page and is drawn as a huge circle, ellipse, or cloud. The related concepts then “leave” this root concept via branch-like tendrils.

The mindmap library of *TikZ* produces mindmaps that look a bit different from the standard mindmaps: While the big root concept is still a circle, related concepts are also depicted as (smaller) circles. The related concepts are linked to the root concept via organic-looking connections. The overall effect is visually rather pleasing, but readers may not immediately think of a mindmap when they see a picture created with this library.

Although it is not strictly necessary, you will usually create mindmaps using *TikZ*’s tree mechanism and some of the styles and macros of the package work best when used inside trees. However, it is still possible and sometimes necessary to treat parts of a mindmap as a graph with arbitrary edges and this is also possible.

### 38.2 The Mindmap Style

Every mindmap should be put in a scope or a picture where the `mindmap` style is used. This style installs some internal settings.

`/tikz/mindmap` (style, no value)

Use this style with all pictures or at least scopes that contain a mindmap. It installs a whole bunch of settings that are useful for drawing mindmaps.

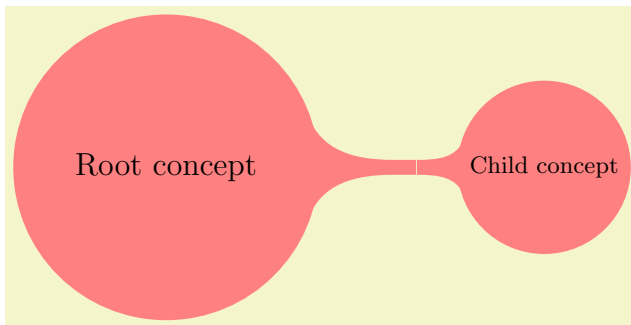

```
\tikz[mindmap,concept color=red!50]  
\node [concept] {Root concept}  
  child[grow=right] {node[concept] {Child concept}};
```

The sizes of concepts are predefined in such a way that a medium-size mindmap will fit on an A4 page (more or less).

`/tikz/every mindmap` (style, no value)

This style is included by the `mindmap` style. Change this style to add special settings to your mindmaps.

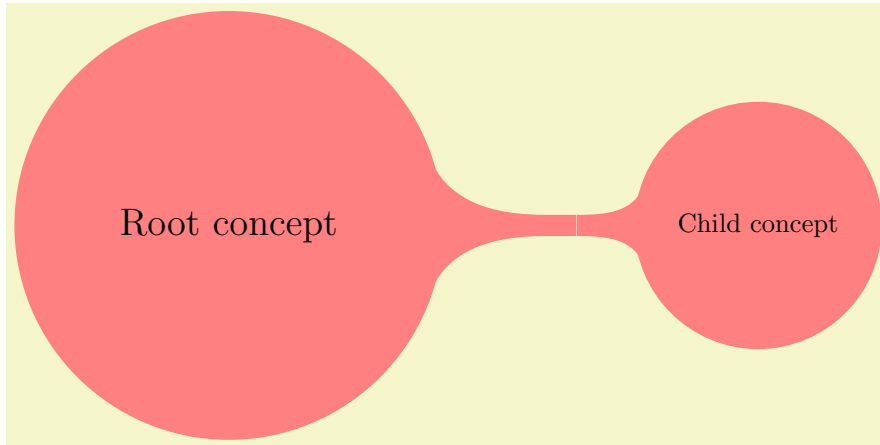

```
\tikz[large mindmap,concept color=red!50]
\node [concept] {Root concept}
  child[grow=right] {node[concept] {Child concept}};
```

`/tikz/large mindmap` (style, no value)

This style includes the `mindmap` style, but additionally changes the default size of concepts and of distances so that a medium-sized mindmap will fit on an A3 page (A3 pages are twice as large as A4 pages).

`/tikz/huge mindmap` (style, no value)

This style causes concepts to be even bigger and it is best used with A2 paper and above.

### 38.3 Concepts Nodes

The basic entities of mindmaps are called *concepts* in TikZ. A concept is a node of style `concept` and it must be circular for some of the connection macros to work.

#### 38.3.1 Isolated Concepts

The following styles influence how isolated concepts are rendered:

`/tikz/concept` (style, no value)

This style should be used with all nodes that are concepts, although some styles like `extra concept` install this style automatically.

Basically, this style makes the concept node circular and installs a uniform color called `concept color`, see below. Additionally, the style `every concept` is called.

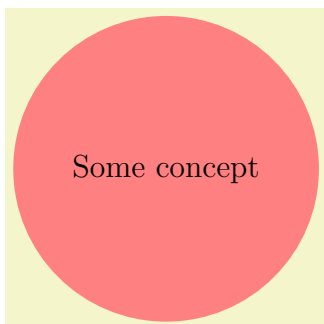

```
\tikz[mindmap,concept color=red!50] \node [concept] {Some concept};
```

`/tikz/every concept` (style, no value)

In order to change the appearance of concept nodes, you should change this style. Note, however, that the color of a concept should be uniform for some of the connection bar stuff to work, so you should not change the color or the draw/fill state of concepts using this option. It is mostly useful for changing the text color and font.

`/tikz/concept color=<color>` (no default)

This option tells TikZ which color should be used for filling and stroking concepts. The difference between this option and just setting `every concept` to the desired color is that this option allows TikZ to keep track of the colors used for concepts. This is important when you *change* the color between two connected concepts. In this case, TikZ can automatically create a shading that provides a smooth transition between the old and the new concept color; we will come back to this in the next section.

`/tikz/extra concept` (style, no value)

This style is intended for concepts that are not part of the “mindmap tree,” but stand beside it. Typically, they will have a subdued color and be smaller. In order to have these concepts appear in a uniform way and in order to indicate in the code that these concepts are extra, you can use this style.

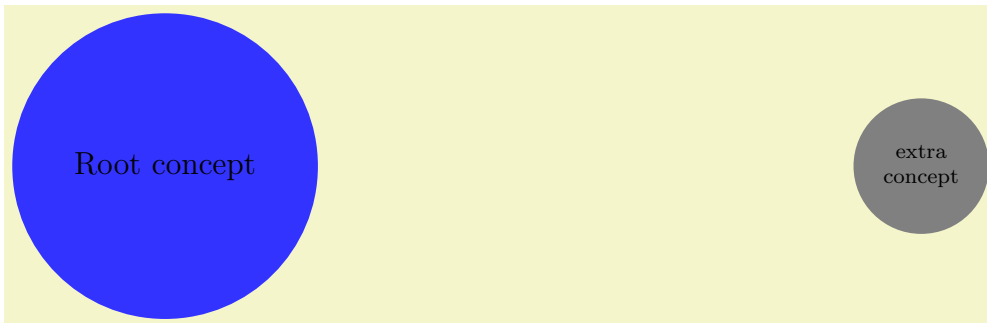

```
\begin{tikzpicture}[mindmap,concept color=blue!80]
  \node [concept] {Root concept};
  \node [extra concept] at (10,0) {extra concept};
\end{tikzpicture}
```

`/tikz/every extra concept` (style, no value)

Change this style to change the appearance of extra concepts.

### 38.3.2 Concepts in Trees

As pointed out earlier, TikZ assumes that your mindmap is built using the `child` facilities of TikZ. There are numerous options that influence how concepts are rendered at the different levels of a tree.

`/tikz/root concept` (style, no value)

This style is used for the roots of mindmap trees. By adding something to this, you can change how the root of a mindmap will be rendered.

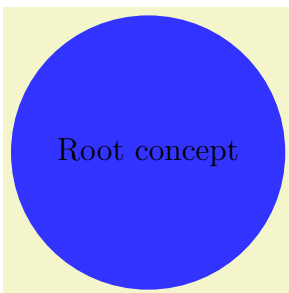

```
\tikz
[root concept/.append style={concept color=blue!80,minimum size=3.5cm},
mindmap]
\node [concept] {Root concept};
```

Note that styles like `large mindmap` redefine these styles, so you should add something to this style only inside the picture.

`/tikz/level 1 concept` (style, no value)

The `mindmap` style adds this style to the `level 1` style. This means that the first level children of a mindmap tree will use this style.

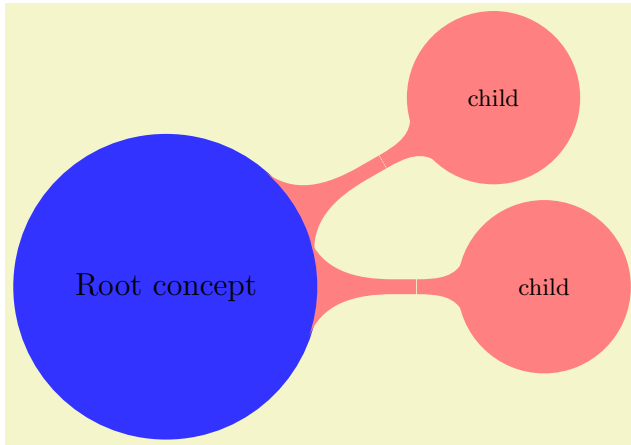

```
\tikz
[root concept/.append style={concept color=blue!80},
 level 1 concept/.append style={concept color=red!50},
 mindmap]
\node [concept] {Root concept}
  child[grow=30] {node[concept] {child}}
  child[grow=0] {node[concept] {child}};
```

`/tikz/level 2 concept` (style, no value)

Works like `level 1 concept`, only for second level children.

`/tikz/level 3 concept` (style, no value)

Works like `level 1 concept`.

`/tikz/level 4 concept` (style, no value)

Works like `level 1 concept`. Note that there are not fifth and higher level styles, you need to modify `level 5` directly in such cases.

`/tikz/concept color=<color>` (no default)

We saw already that this option is used to change the color of concepts. We now have a look at its effect when used on child nodes of a concept. Normally, this option simply changes the color of the children. However, when the option is given as an option to the `child` operation (and not to the `node` operation and also not as an option to all children via the `level 1` style), TikZ will smoothly change the concept color from the parent's color to the color of the child concept.

Here is an example:

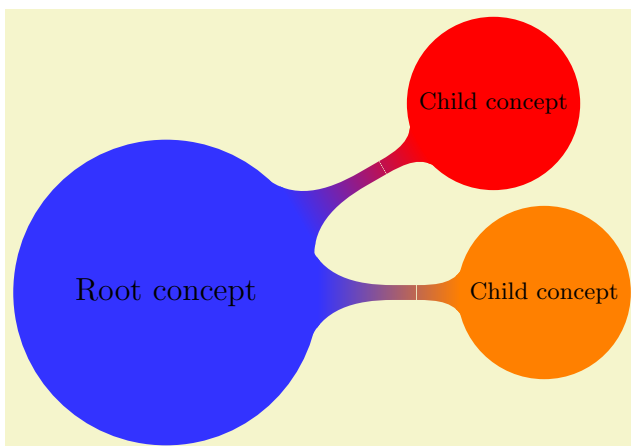

```
\tikz[mindmap,concept color=blue!80]
\node [concept] {Root concept}
  child[concept color=red,grow=30] {node[concept] {Child concept}}
  child[concept color=orange,grow=0] {node[concept] {Child concept}};
```

In order to have all children of a certain level have a different concept color, a tiny bit of magic is needed:

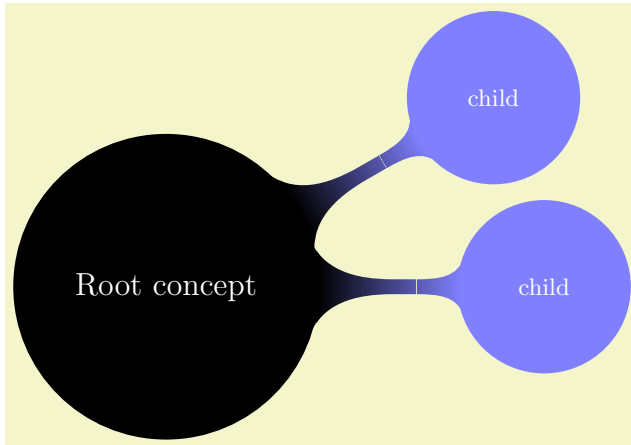

```

\tikz[mindmap,text=white,
      root concept/.style={concept color=blue},
      level 1 concept/.append style=
        {every child/.style={concept color=blue!50}}]
\node [concept] {Root concept}
child[grow=30] {node[concept] {child}}
child[grow=0 ] {node[concept] {child}};

```

## 38.4 Connecting Concepts

### 38.4.1 Simple Connections

The easiest way to connect two concepts is to draw a line between them. In order to give such lines a consistent appearance, it is recommendable to use the following style when drawing such lines:

`/tikz/concept connection` (style, no value)

This style can be used for lines between two concepts. Feel free to redefine this style.

A problem arises when you need to connect concepts after the main mindmap has been drawn. In this case you will want the connection lines to lie *behind* the main mindmap. However, you can draw the lines only after the coordinates of the concepts have been determined. In this case you should place the connecting lines on a background layer as in the following example:

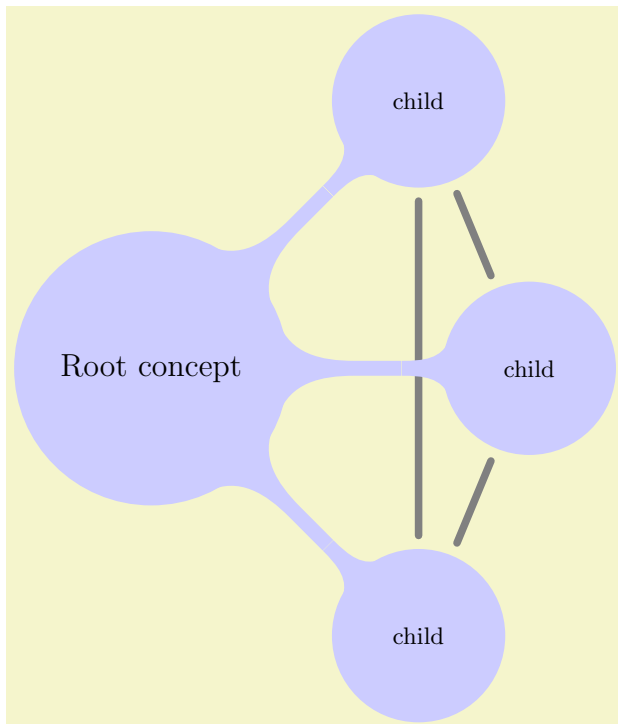

```

\begin{tikzpicture}
  [root concept/.append style={concept color=blue!20,minimum size=2cm},
  level 1 concept/.append style={sibling angle=45},
  mindmap]
  \node [concept] {Root concept}
    [clockwise from=45]
    child { node[concept] (c1) {child}}
    child { node[concept] (c2) {child}}
    child { node[concept] (c3) {child}};
  \begin{pgfonlayer}{background}
    \draw [concept connection] (c1) edge (c2)
                                         edge (c3)
                                         (c2) edge (c3);
  \end{pgfonlayer}
\end{tikzpicture}

```

### 38.4.2 The Circle Connection Bar Decoration

Instead of a simple line between two concepts, you can also add a bar between the two nodes that has slightly organic ends. These bars are also used by default as the edges from parents in the mindmap tree.

For the drawing of the bars a special decoration is used, which is defined in the mindmap library:

Decoration `circle connection bar`

This decoration can be used to connect two circles. The start of the to-be-decorated path should lie on the border of the first circle, the end should lie on the border of the second circle. The following two decoration keys should be initialized with the sizes of the circles:

- `start radius`
- `end radius`

Furthermore, the following two decoration keys influence the decoration:

- `amplitude`
- `angle`

The decoration turns a straight line into a path that starts on the border of the first circle at the specified angle relative to the line connecting the centers of the circles. The path then changes into a rectangle whose thickness is given by the amplitude. Finally, the path ends with the same angles on the second circle.

Here is an example that should make this clearer:

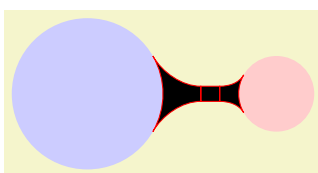

```

\begin{tikzpicture}
  [decoration={start radius=1cm,end radius=.5cm,amplitude=2mm,angle=30}]
  \fill[blue!20] (0,0) circle (1cm);
  \fill[red!20] (2.5,0) circle (.5cm);

  \filldraw [draw=red,fill=black,
            decorate,decoration=circle connection bar] (1,0) -- (2,0);
\end{tikzpicture}

```

As can be seen, the decorated path consists of three parts and is not really useful for drawing. However, if you fill the decorated path only, and if you use the same color as for the circles, the result is better.

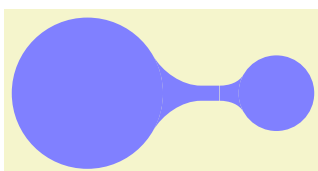

```

\begin{tikzpicture}
  [blue!50,decoration={start radius=1cm,
                       end radius=.5cm,amplitude=2mm,angle=30}]
  \fill (0,0) circle (1cm);
  \fill (2.5,0) circle (.5cm);

  \fill [decorate,decoration=circle connection bar] (1,0) -- (2,0);
\end{tikzpicture}

```

In the above example you may notice the small white line between the circles and the decorated path. This is due to rounding errors. Unfortunately, for larger distances, there errors can accumulate quite strongly, especially since `TikZ` and `TeX` are not very good at computing square roots. For this reason, it is a good idea to make the circles slightly larger to cover up such problems. When using nodes of



shape `circle`, you can just add the `draw` option with a `line width` or one or two points (for very large distances you may need line width up to 4pt).

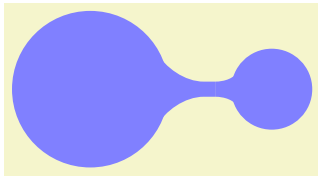

```
\begin{tikzpicture}
[blue!50,decoration={start radius=1cm,
                    end radius=.5cm,amplitude=2mm,angle=30}]
\fill (0,0) circle (1cm+1pt);
\fill (2.4,0) circle (.5cm+1pt);

\fill [decorate,decoration=circle connection bar] (1,0) -- (1.9,0);
\end{tikzpicture}
```

Note the slightly strange `outer sep=0pt`. This is needed so that the decorated path lies on the border of the filled circle, not on the border of the stroked circle (which is slightly larger and this slightly larger size is exactly what we wish to use to cover up the rounding errors).

### 38.4.3 The Circle Connection Bar To-Path

The `circle connection bar` decoration is a bit complicated to use. Especially specifying the radii is quite bothersome (the amplitude and the angle can be set once and for all). For this reason, the `mindmap` library defines a special to-path, that performs the necessary computations for you.

`/tikz/circle connection bar` (style, no value)

This style installs a rather involved to-path. Unlike normal to-paths, this path requires that the start and the target of the to-path are named nodes of shape `circle` – if this is not the case, this path will produce errors.

Assuming that the start and the target are circles, the to-path will first compute the radii of these circles (by measuring the distance from the `center` anchor to some anchor on the border) and will set the `start circle` keys accordingly. Next, the `fill` option is set to the `concept color` while `draw=none` is set. The decoration is set to `circle connection bar`. Finally, the following style is included:

`/tikz/every circle connection bar` (style, no value)

Redefine this style to change the appearance of circle connection bar to-paths.

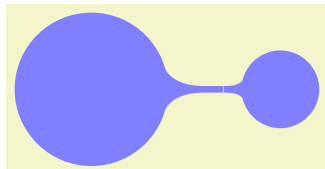

```
\begin{tikzpicture}[concept color=blue!50,blue!50,outer sep=0pt]
\node (n1) at (0,0) [circle,minimum size=2cm,fill,draw,thick] {};
\node (n2) at (2.5,0) [circle,minimum size=1cm,fill,draw,thick] {};

\path (n1) to[circle connection bar] (n2);
\end{tikzpicture}
```

Note that it is not a good idea to have more than one to operation together this the option `circle connection bar` in a single `\path`. Use the `edge` operation, instead, for creating multiple connections and this operation creates a new scope for each edge.

In a mindmap we sometimes want colors to change from one concept color to another. Then, the connection bar should, ideally, consist of a smooth transition between these two colors. Getting this right using shadings is a bit tricky if you try this “by hand,” so the `mindmap` library provides a special option for facilitating this procedure.

`/tikz/circle connection bar switch color=from (<first color>) to (<second color>)` (no default)

This style works similarly to the `circle connection bar`. The only difference is that instead of filling the path with a single color a shading is used.

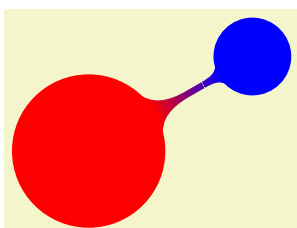

```
\begin{tikzpicture}[outer sep=0pt]
\node (n1) at (0,0) [circle,minimum size=2cm,fill,draw,thick,red] {};
\node (n2) at (30:2.5) [circle,minimum size=1cm,fill,draw,thick,blue] {};

\path (n1) to[circle connection bar switch color=from (red) to (blue)] (n2);
\end{tikzpicture}
```

### 38.4.4 Tree Edges

Most of the time, concepts in a mindmap are connected automatically when the mindmap is build as a tree. The reason is that the `mindmap` installs a `circle connection bar` path as the edge from parent path. Also, the `mindmap` option takes care of things like setting the correct `draw` and `outer sep` settings and some other stuff.

In detail, the `mindmap` option sets the `edge from parent path` to a path that uses the `to-path circle connection bar` to connect the parent node and the child node. The `concept color` option (locally) changes this by using `circle connection bar switch color` instead with the `from-color` set to the old (parent's) concept color and the `to-color` set to the new (child's) concept color. This means that when you provide the `concept color` option to a `child` command, the color will change from the parent's concept color to the specified color.

Here is an example of a tree build in this way:

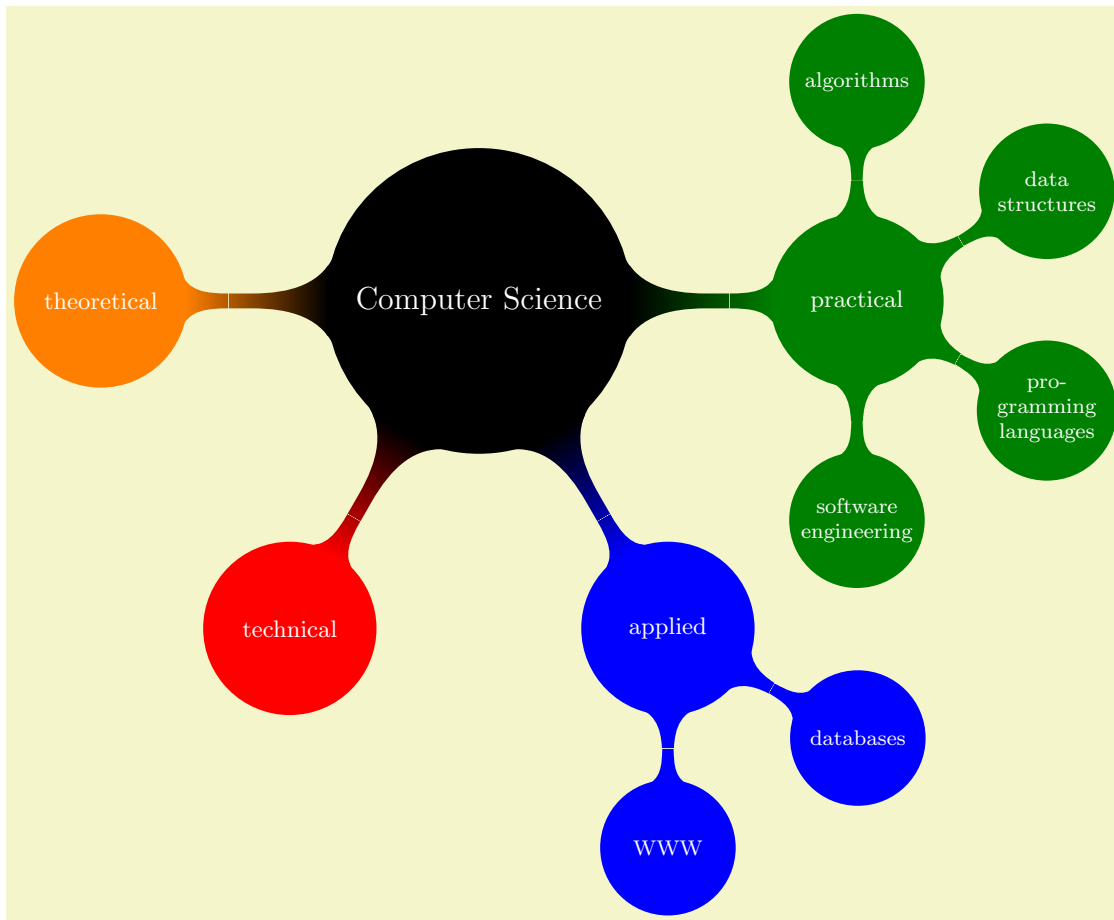

```

\begin{tikzpicture}
  \path[mindmap,concept color=black,text=white]
    node[concept] {Computer Science}
    [clockwise from=0]
    child[concept color=green!50!black] {
      node[concept] {practical}
      [clockwise from=90]
      child { node[concept] {algorithms} }
      child { node[concept] {data structures} }
      child { node[concept] {pro\~gramming languages} }
      child { node[concept] {software engineer\~ing} }
    }
    child[concept color=blue] {
      node[concept] {applied}
      [clockwise from=-30]
      child { node[concept] {databases} }
      child { node[concept] {WWW} }
    }
    child[concept color=red] { node[concept] {technical} }
    child[concept color=orange] { node[concept] {theoretical} };
\end{tikzpicture}

```

## 38.5 Adding Annotations

An *annotation* is some text outside a mindmap that, unlike an extra concept, simply explains something in the mindmap. The following style is mainly intended to help readers of the code see that a node in an annotation node.

`/tikz/annotation`

(style, no value)

This style indicates that a node is an annotation node. It includes the style `every annotation`, which allows you to change this style in a convenient fashion.

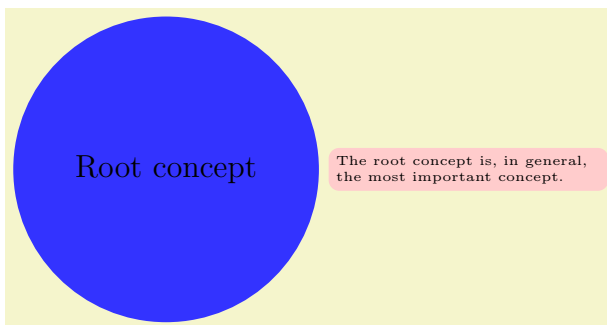

```

\begin{tikzpicture}
  [mindmap,concept color=blue!80,
  every annotation/.style={fill=red!20}]
  \node [concept] (root) {Root concept};

  \node [annotation,right] at (root.east)
  {The root concept is, in general, the most important concept.};
\end{tikzpicture}

```

`/tikz/every annotation`

(style, no value)

This style is included by `annotation`.

## 39 Paper Folding Diagrams Library

`\usetikzlibrary{folding}` %  $\text{\LaTeX}$  and plain  $\text{\TeX}$

`\usetikzlibrary[folding]` %  $\text{Con}\text{\TeX}$ t

This library defines commands for creating paper folding diagrams. Currently, it just contains a single command for creating a single diagram, but that one is really useful for creating calendars for your (real) desktop.

`\tikzfoldingdodecahedron[options];`

This command draws a folding diagram for a dodecahedron. The syntax is intended to remind of the `\path` command, but (currently) you must specify the *options* and nothing else may be specified between the command name and the closing semicolon.

The following keys may be used in the *options*:

`/tikz/folding line length=dimension` (no default)

Sets the length of the base line for folding. For the dodecahedron this is the length of all the sides of the pentagons.

`/tikz/face 1=code` (no default)

The *code* is executed for the first face of the dodecahedron. When it is executed, the coordinate system will have been shifted and rotated such that it lies at the middle of the first face of the dodecahedron.

`/tikz/face 2=code` (no default)

Same as face 1, but for the second face.

`/tikz/face 3=code` (no default)

Same as face 1, but for the third face.

There are further similar options, ending with the following:

`/tikz/face 12=code` (no default)

Same as face 1, but for the last face.

Here is a simple example:

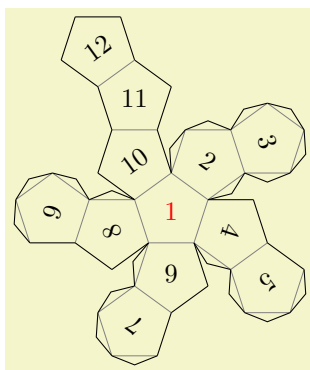

```
\begin{tikzpicture}[transform shape]
\tikzfoldingdodecahedron
[folding line length=6mm,
face 1={ \node[red] {1};},
face 2={ \node {2};},
face 3={ \node {3};},
face 4={ \node {4};},
face 5={ \node {5};},
face 6={ \node {6};},
face 7={ \node {7};},
face 8={ \node {8};},
face 9={ \node {9};},
face 10={\node {10};},
face 11={\node {11};},
face 12={\node {12};},
\end{tikzpicture}
```

The appearance of the cut and folding lines can be influenced using the following styles:

`/tikz/every cut` (style, initially empty)

Executed for every line that should be cut using scissors.

`/tikz/every fold` (style, initially help lines)

Executed for every line that should be folded.

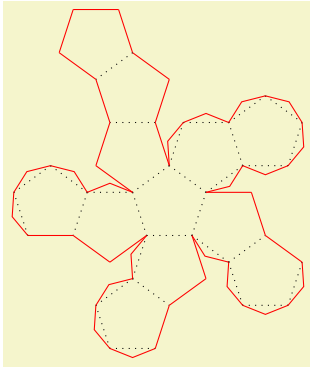

```
\begin{tikzpicture}[every cut/.style=red,every fold/.style=dotted]
  \tikzfoldingdodecahedron[folding line length=6mm];
\end{tikzpicture}
```

Here is a big example that produces a diagram for a calendar:

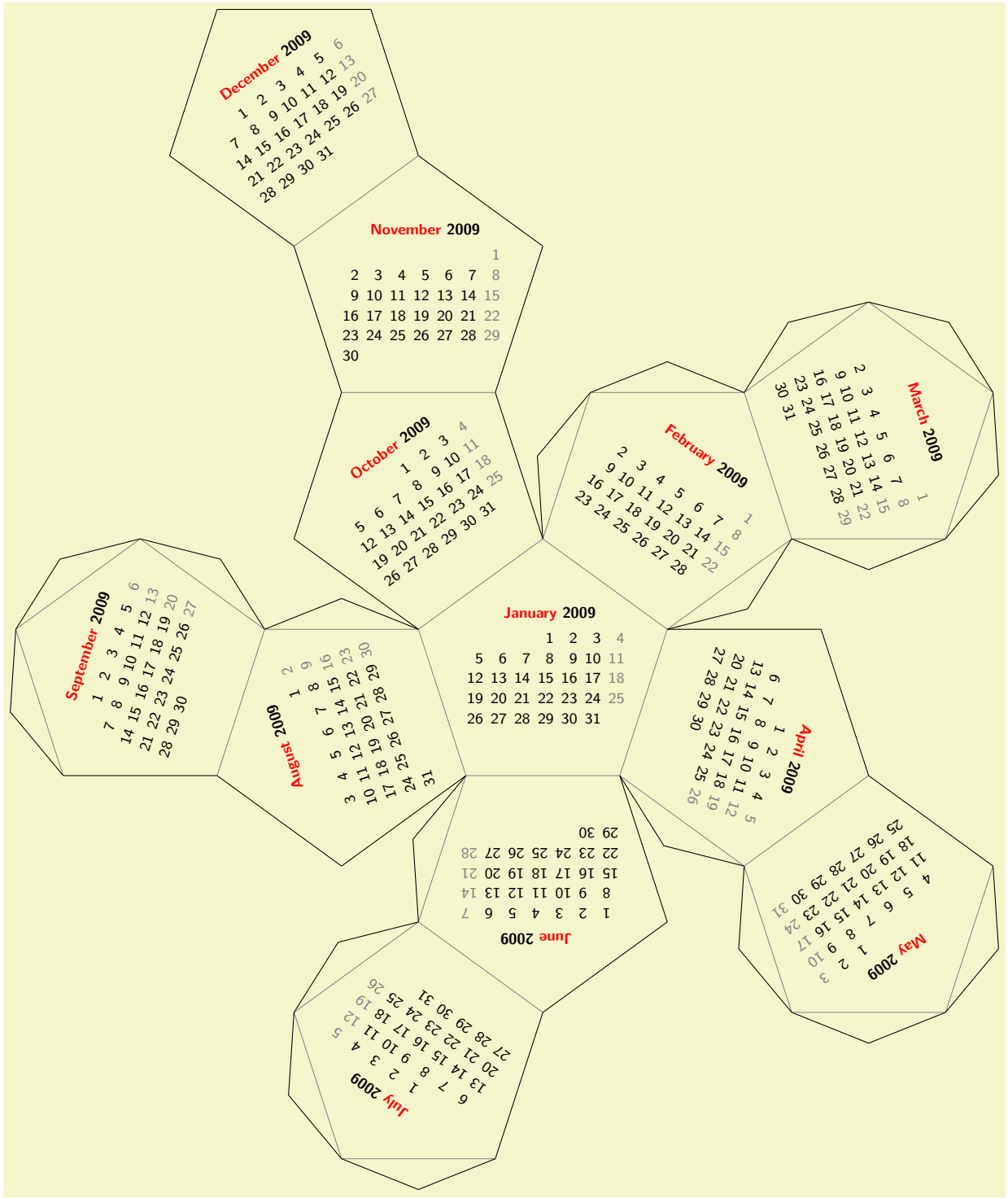

```

\sfamily\scriptsize
\begin{tikzpicture}
  [transform shape,
  every calendar/.style=
  {
    at={(-8ex,4ex)},
    week list,
    month label above centered,
    month text=\bfseries\textcolor{red}{\%mt} \%y0,
    if={(Sunday) [black!50]}
  }]
\tikzfoldingdodecahedron
[
  folding line length=2.5cm,
  face 1={ \calendar [dates=\the\year-01-01 to \the\year-01-last];},
  face 2={ \calendar [dates=\the\year-02-01 to \the\year-02-last];},
  face 3={ \calendar [dates=\the\year-03-01 to \the\year-03-last];},
  face 4={ \calendar [dates=\the\year-04-01 to \the\year-04-last];},
  face 5={ \calendar [dates=\the\year-05-01 to \the\year-05-last];},
  face 6={ \calendar [dates=\the\year-06-01 to \the\year-06-last];},
  face 7={ \calendar [dates=\the\year-07-01 to \the\year-07-last];},
  face 8={ \calendar [dates=\the\year-08-01 to \the\year-08-last];},
  face 9={ \calendar [dates=\the\year-09-01 to \the\year-09-last];},
  face 10={ \calendar [dates=\the\year-10-01 to \the\year-10-last];},
  face 11={ \calendar [dates=\the\year-11-01 to \the\year-11-last];},
  face 12={ \calendar [dates=\the\year-12-01 to \the\year-12-last];}
];
\end{tikzpicture}

```











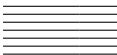

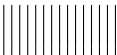
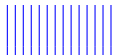
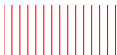

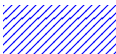





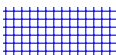







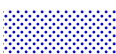



## 40 Pattern Library

```
\usepgflibrary{patterns} %  $\TeX$  and plain  $\TeX$  and pure pgf
\usepgflibrary[patterns] % Con $\TeX$ t and pure pgf
\usetikzlibrary{patterns} %  $\TeX$  and plain  $\TeX$  when using TikZ
\usetikzlibrary[patterns] % Con $\TeX$ t when using TikZ
```

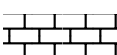

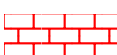





The package defines patterns for filling areas.

### 40.1 Form-Only Patterns

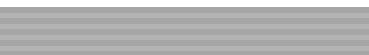
*Pattern name*                      *Example (pattern in black, blue, and red on faded checkerboard)*

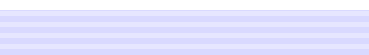
|                   |                                                                                     |                                                                                     |                                                                                     |
|-------------------|-------------------------------------------------------------------------------------|-------------------------------------------------------------------------------------|-------------------------------------------------------------------------------------|
| horizontal lines  |    |    |    |
| vertical lines    |    |    |    |
| north east lines  |    |    |    |
| north west lines  |    |    |    |
| grid              |    |    |    |
| crosshatch        |    |    |    |
| dots              |    |    |    |
| crosshatch dots   |  |  |  |
| fivepointed stars |  |  |  |
| sixpointed stars  |  |  |  |
| bricks            |  |  |  |
| checkerboard      |  |  |  |

### 40.2 Inherently Colored Patterns

| <i>Pattern name</i>              | <i>Example</i>                                                                       |
|----------------------------------|--------------------------------------------------------------------------------------|
| checkerboard light gray          |  |
| horizontal lines light gray      |  |
| horizontal lines gray            |  |
| horizontal lines dark gray       |  |
| horizontal lines light blue      |  |
| horizontal lines dark blue       |  |
| crosshatch dots gray             |  |
| crosshatch dots light steel blue |  |



## 41 Petri-Net Drawing Library

```
\usetikzlibrary{petri} %  $\TeX$  and plain  $\TeX$ 
\usetikzlibrary[petri] % Con $\TeX$ t
```

This packages provides shapes and styles for drawing Petri nets.

### 41.1 Places

The package defines a style for drawing places of Petri nets.

`/tikz/place` (style, no value)

This style indicates that a node is a place of a Petri net. Usually, the text of the node should be empty since places do not contain any text. You should use the `label` option to add text outside the node like its name or its capacity. You should use the `tokens` options, explained in Section 41.3, to add tokens inside the place.

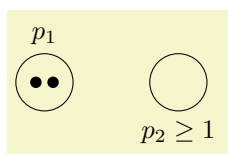

```
\begin{tikzpicture}
  \node[place,label=above:$p_1$,tokens=2] (p1) {};
  \node[place,label=below:$p_2\ge 1$,right=of p1] (p2) {};
\end{tikzpicture}
```

`/tikz/every place` (style, no value)

This style is invoked by the style `place`. To change the appearance of places, you can change this style.

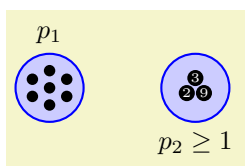

```
\begin{tikzpicture}
  [every place/.style={draw=blue,fill=blue!20,thick,minimum size=9mm}]
  \node[place,tokens=7,label=above:$p_1$] (p1) {};
  \node[place,structured tokens={3,2,9},
        label=below:$p_2\ge 1$,right=of p1] (p2) {};
\end{tikzpicture}
```

### 41.2 Transitions

Transitions are also nodes. They should be drawn using the following style:

`/tikz/transition` (style, no value)

This style indicates that a node is a transition. As for places, the text of a transition should be empty and the `label` option should be used for adding labels.

To connect a transition to places, you can use the `edge` command as in the following example:

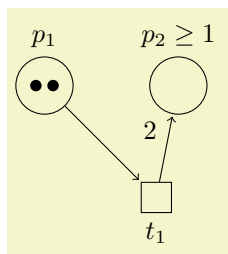

```
\begin{tikzpicture}
  \node[place,tokens=2,label=above:$p_1$] (p1) {};
  \node[place,label=above:$p_2\ge 1$,right=of p1] (p2) {};

  \node[transition,below right=of p1,label=below:$t_1$] {}
    edge[pre] (p1)
    edge[post] node[auto] {2} (p2);
\end{tikzpicture}
```

`/tikz/every transition` (style, no value)

This style is invoked by the style `transition`.

`/tikz/pre` (style, no value)

This style can be used with paths leading *from* a transition *to* a place to indicate that the place is in the pre-set of the transition. By default, this style is `<-`, `shorten <=1pt`, but feel free to redefine it.

`/tikz/post` (style, no value)

This style is also used with paths leading *from* a transition *to* a place, but this time the place is in the post-set of the transition. Again, feel free to redefine it.

`/tikz/pre and post` (style, no value)

This style is to be used to indicate that a place is both in the pre- and post-set of a transition.

### 41.3 Tokens

Interestingly, the most complicated aspect of drawing Petri nets in TikZ turns out to be the placement of tokens.

Let us start with a single token. They are also nodes and there is a simple style for typesetting them.

`/tikz/token` (style, no value)

This style indicates that a node is a token. By default, this causes the node to be a small black circle. Unlike places and transitions, it *does* make sense to provide text for the token node. Such text will be typeset in a tiny font and in white on black (naturally, you can easily change this by setting the style `every token`).

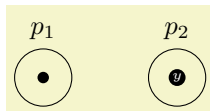

```
\begin{tikzpicture}
  \node[place,label=above:$p_1$] (p1) {};
  \node[token] at (p1) {};

  \node[place,label=above:$p_2$,right=of p1] (p2) {};
  \node[token] at (p2) {$y$};
\end{tikzpicture}
```

`/tikz/every token` (style, no value)

Change this style to change the appearance of tokens.

In the above example, it is bothersome that we need an extra command for the token node. Worse, when we have *two* tokens on a node, it is difficult to place both nodes inside the node without overlap.

The Petri net library offers a solution to this problem: The `children are tokens` style.

`/tikz/children are tokens` (style, no value)

The idea behind this style is to use trees mechanism for placing tokens. Every token lying on a place is treated as a child of the node. Normally this would have the effect that the tokens are placed below the place and they would be connected to the place by an edge. The `children are tokens` style, however, redefines the growth function of trees such that it places the children next to each other inside (or, rather, on top) of the place node. Additionally, the edge from the parent node is not drawn.

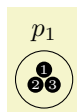

```
\begin{tikzpicture}
  \node[place,label=above:$p_1$] {}
  [children are tokens]
  child {node [token] {1}}
  child {node [token] {2}}
  child {node [token] {3}};
\end{tikzpicture}
```

In detail, what happens is the following: Tree growth functions tell TikZ where it should place the children of nodes. These functions get passed the number of children that a node has and the number of the child that should be placed. The special tree growth function for tokens has a special mapping for each possible number of children up to nine children. This mapping decides for each child where it should be placed on top of the place. For example, a single child is placed directly on top of the place. Two children are placed next to each other, separated by the `token distance`. Three children are placed in a triangle whose side lengths are `token distance`; and so on up to nine tokens. If you wish to place more than nine tokens on a place, you will have to write your own placement code.

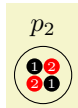

```

\begin{tikzpicture}
  \node[place,label=above:$p_2$] {}
  [children are tokens]
  child {node [token] {1}}
  child {node [token,fill=red] {2}}
  child {node [token,fill=red] {2}}
  child {node [token] {1}};
\end{tikzpicture}

```

`/tikz/token distance=<distance>` (no default)

This specifies the distance between the centers of the tokens in the arrangements of the option `children are tokens`.

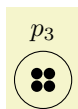

```

\begin{tikzpicture}
  \node[place,label=above:$p_3$] {}
  [children are tokens,token distance=1.1ex]
  child {node [token] {}}
  child {node [token,red] {}}
  child {node [token,blue] {}}
  child {node [token] {}};
\end{tikzpicture}

```

The `children are tokens` options gives you a lot of flexibility, but it is a bit cumbersome to use. For this reason there are some options that help in standard situations. They all use `children are tokens` internally, so any change to, say, the `every tokens` style will affect how these options depict tokens.

`/tikz/tokens=<number>` (no default)

This option is given to a `place` node, not to a `token` node. The effect of this option is to add `<number>` many child nodes to the place, each having the style `token`. Thus, the following two pieces of codes have the same effect:

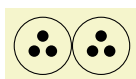

```

\tikz
  \node[place] {}
  [children are tokens]
  child {node [token] {}}
  child {node [token] {}}
  child {node [token] {}};
\tikz
  \node[place,tokens=3] {};

```

It is legal to say `tokens=0`, no tokens are drawn in this case. This option does not handle ten or more tokens correctly. If you need this many tokens, you will have to program your own code.

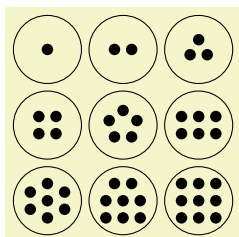

```

\begin{tikzpicture}[every place/.style={minimum size=9mm}]
  \foreach \x/\y/\tokennumber in {0/2/1,1/2/2,2/2/3,
    0/1/4,1/1/5,2/1/6,
    0/0/7,1/0/8,2/0/9}
    \node [place,tokens=\tokennumber] at (\x,\y) {};
\end{tikzpicture}

```

`/tikz/colored tokens=<color list>` (no default)

This option, which must also be given when a place node is being created, gets a list of colors as parameter. It will then add as many tokens to the place as in this list, each colored with the corresponding color in the list.



```

\tikz \node[place,colored tokens={black,black,red,blue}] {};

```

`/tikz/structured tokens=<token texts>` (no default)

This option, which must again be passed to a place, gets a list texts for tokens. For each text, another token will be added to the place.



```
\tikz \node[place,structured tokens={x$,y$,z$}] {};
```

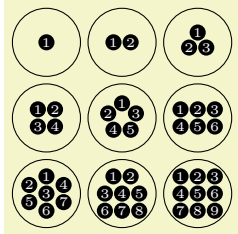

```
\begin{tikzpicture}[every place/.style={minimum size=9mm}]
\foreach \x/\y/\tokennumber in {0/2/1,1/2/2,2/2/3,
0/1/4,1/1/5,2/1/6,
0/0/7,1/0/8,2/0/9}
\node [place,structured tokens={1,...,\tokennumber}] at (\x,\y) {};
\end{tikzpicture}
```

If you use lots of structured tokens, consider redefining the `every token` style so that the tokens are larger.

### 41.4 Examples

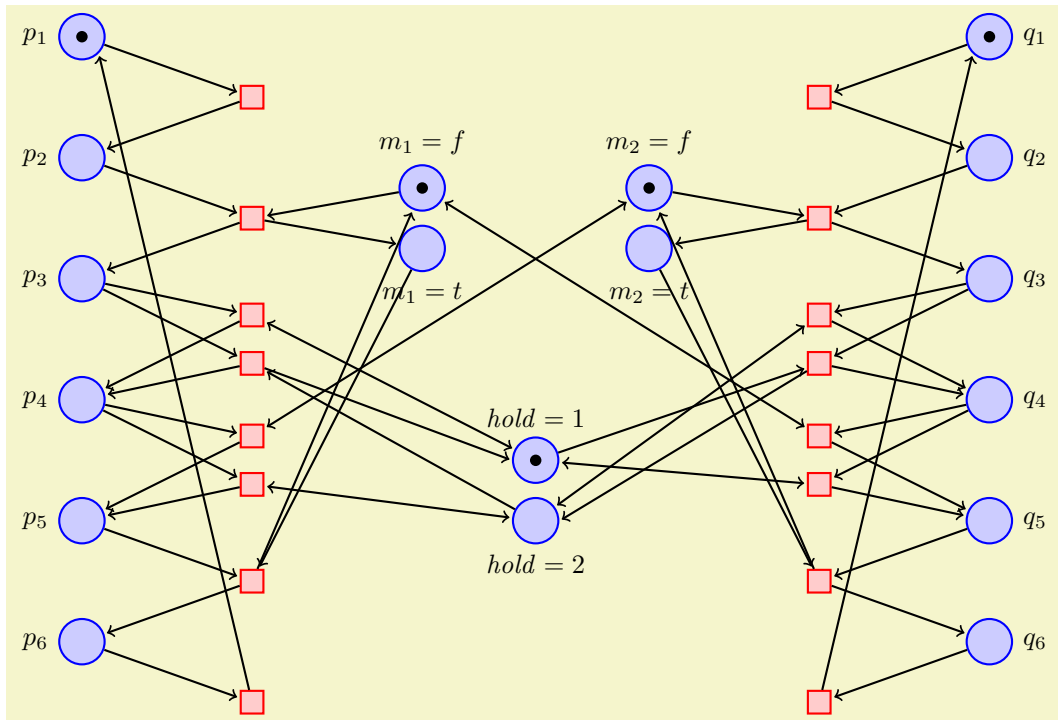

```

\begin{tikzpicture}[yscale=-1.6,xscale=1.5,thick,
every transition/.style={draw=red,fill=red!20,minimum size=3mm},
every place/.style={draw=blue,fill=blue!20,minimum size=6mm}]

\foreach \i in {1,...,6} {
\node[place,label=left:$p_{\i}$] (p\i) at (0,\i) {};
\node[place,label=right:$q_{\i}$] (q\i) at (8,\i) {};
}
\foreach \name/\var/\vala/\valb/\height/\x in
{m1/m_1/f/t/2.25/3,m2/m_2/f/t/2.25/5,h/\mathit{hold}/1/2/4.5/4} {
\node[place,label=above:{$\var = \vala$}] (\name\vala) at (\x,\height) {};
\node[place,yshift=-8mm,label=below:{$\var = \valb$}] (\name\valb) at (\x,\height) {};
}
\node[token] at (p1) {}; \node[token] at (q1) {};
\node[token] at (m1f) {}; \node[token] at (m2f) {};
\node[token] at (h1) {};

\node[transition] at (1.5,1.5) {} edge [pre] (p1) edge [post] (p2);
\node[transition] at (1.5,2.5) {} edge[pre] (p2) edge[pre] (m1f);
edge[post] (p3) edge[post] (m1t);
\node[transition] at (1.5,3.3) {} edge [pre] (p3) edge [post] (p4)
edge [pre and post] (h1);
\node[transition] at (1.5,3.7) {} edge [pre] (p3) edge [pre] (h2)
edge [post] (p4) edge [post] (h1.west);
\node[transition] at (1.5,4.3) {} edge [pre] (p4) edge [post] (p5)
edge [pre and post] (m2f);
\node[transition] at (1.5,4.7) {} edge [pre] (p4) edge [post] (p5)
edge [pre and post] (h2);
\node[transition] at (1.5,5.5) {} edge [pre] (p5) edge [pre] (m1t)
edge [post] (p6) edge [post] (m1f);
\node[transition] at (1.5,6.5) {} edge [pre] (p6) edge [post] (p1.south east);
\node[transition] at (6.5,1.5) {} edge [pre] (q1) edge [post] (q2);
\node[transition] at (6.5,2.5) {} edge [pre] (q2) edge [pre] (m2f)
edge [post] (q3) edge [post] (m2t);
\node[transition] at (6.5,3.3) {} edge [pre] (q3) edge [post] (q4)
edge [pre and post] (h2);
\node[transition] at (6.5,3.7) {} edge [pre] (q3) edge [pre] (h1)
edge [post] (q4) edge [post] (h2.east);
\node[transition] at (6.5,4.3) {} edge [pre] (q4) edge [post] (q5)
edge [pre and post] (m1f);
\node[transition] at (6.5,4.7) {} edge [pre] (q4) edge [post] (q5)
edge [pre and post] (h1);
\node[transition] at (6.5,5.5) {} edge [pre] (q5) edge [pre] (m2t)
edge [post] (q6) edge [post] (m2f);
\node[transition] at (6.5,6.5) {} edge [pre] (q6) edge [post] (q1.south west);
\end{tikzpicture}

```

Here is the same net once more, but with these styles changes:

```

\begin{tikzpicture}[yscale=-1.1,thin,>=stealth,
every transition/.style={fill,minimum width=1mm,minimum height=3.5mm},
every place/.style={draw,thick,minimum size=6mm}]

```

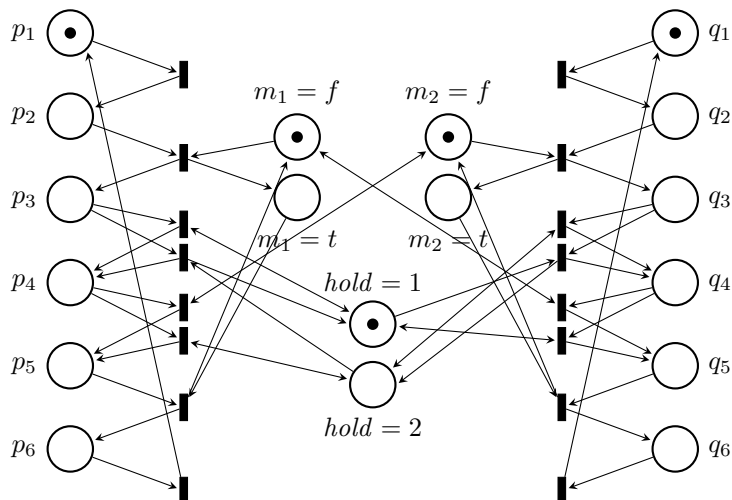

## 42 Plot Handler Library

```
\usepgflibrary{plohandlers} %  $\LaTeX$  and plain  $\TeX$  and pure pgf
\usepgflibrary[plohandlers] % Con $\TeX$ t and pure pgf
\usetikzlibrary{plohandlers} %  $\LaTeX$  and plain  $\TeX$  when using TikZ
\usetikzlibrary[plohandlers] % Con $\TeX$ t when using TikZ
```

This library packages defines additional plot handlers, see Section 81.3 for an introduction to plot handlers. The additional handlers are described in the following.

This library is loaded automatically by TikZ.

### 42.1 Curve Plot Handlers

#### `\pgfplothandlercurveto`

This handler will issue a `\pgfpathcurveto` command for each point of the plot, *except* possibly for the first. As for the line-to handler, what happens with the first point can be specified using `\pgfsetmovetofirstplotpoint` or `\pgfsetlinetofirstplotpoint`.

Obviously, the `\pgfpathcurveto` command needs, in addition to the points on the path, some control points. These are generated automatically using a somewhat “dumb” algorithm: Suppose you have three points  $x$ ,  $y$ , and  $z$  on the curve such that  $y$  is between  $x$  and  $z$ :

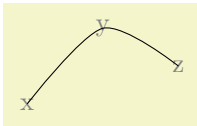

```
\begin{tikzpicture}
\draw[gray] (0,0) node {x} (1,1) node {y} (2,.5) node {z};
\pgfplothandlercurveto
\pgfplotstreamstart
\pgfplotstreampoint{\pgfpoint{0cm}{0cm}}
\pgfplotstreampoint{\pgfpoint{1cm}{1cm}}
\pgfplotstreampoint{\pgfpoint{2cm}{.5cm}}
\pgfplotstreamend
\pgfusepath{stroke}
\end{tikzpicture}
```

In order to determine the control points of the curve at the point  $y$ , the handler computes the vector  $z - x$  and scales it by the tension factor (see below). Let us call the resulting vector  $s$ . Then  $y + s$  and  $y - s$  will be the control points around  $y$ . The first control point at the beginning of the curve will be the beginning itself, once more; likewise the last control point is the end itself.

#### `\pgfsetplottension{value}`

Sets the factor used by the curve plot handlers to determine the distance of the control points from the points they control. The higher the curvature of the curve points, the higher this value should be. A value of 1 will cause four points at quarter positions of a circle to be connected using a circle. The default is 0.5.

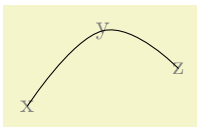

```
\begin{tikzpicture}
\draw[gray] (0,0) node {x} (1,1) node {y} (2,.5) node {z};
\pgfsetplottension{0.75}
\pgfplothandlercurveto
\pgfplotstreamstart
\pgfplotstreampoint{\pgfpoint{0cm}{0cm}}
\pgfplotstreampoint{\pgfpoint{1cm}{1cm}}
\pgfplotstreampoint{\pgfpoint{2cm}{0.5cm}}
\pgfplotstreamend
\pgfusepath{stroke}
\end{tikzpicture}
```

#### `\pgfplothandlerclosedcurve`

This handler works like the curve-to plot handler, only it will add a new part to the current path that is a closed curve through the plot points.

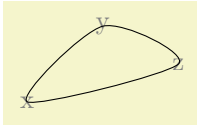

```
\begin{tikzpicture}
\draw[gray] (0,0) node {x} (1,1) node {y} (2,.5) node {z};
\pgfplotstreamclosedcurve
\pgfplotstreamstart
\pgfplotstreampoint{\pgfpoint{0cm}{0cm}}
\pgfplotstreampoint{\pgfpoint{1cm}{1cm}}
\pgfplotstreampoint{\pgfpoint{2cm}{0.5cm}}
\pgfplotstreamend
\pgfusepath{stroke}
\end{tikzpicture}
```

## 42.2 Constant Plot Handlers

There are three plot handlers which produce piecewise constant interpolations between successive points.

### `\pgfplotstreamconstantlineto`

This handler works like the line-to plot handler, only it will produce a connected, piecewise constant path to connect the points.

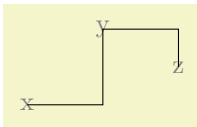

```
\begin{tikzpicture}
\draw[gray] (0,0) node {x} (1,1) node {y} (2,.5) node {z};
\pgfplotstreamconstantlineto
\pgfplotstreamstart
\pgfplotstreampoint{\pgfpoint{0cm}{0cm}}
\pgfplotstreampoint{\pgfpoint{1cm}{1cm}}
\pgfplotstreampoint{\pgfpoint{2cm}{0.5cm}}
\pgfplotstreamend
\pgfusepath{stroke}
\end{tikzpicture}
```

### `\pgfplotstreamconstantlinetomarkright`

A variant of `\pgfplotstreamconstantlineto` which places its mark on the right line ends.

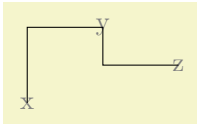

```
\begin{tikzpicture}
\draw[gray] (0,0) node {x} (1,1) node {y} (2,.5) node {z};
\pgfplotstreamconstantlinetomarkright
\pgfplotstreamstart
\pgfplotstreampoint{\pgfpoint{0cm}{0cm}}
\pgfplotstreampoint{\pgfpoint{1cm}{1cm}}
\pgfplotstreampoint{\pgfpoint{2cm}{0.5cm}}
\pgfplotstreamend
\pgfusepath{stroke}
\end{tikzpicture}
```

### `\pgfplotstreamjumpmarkleft`

This handler works like the line-to plot handler, only it will produce a non-connected, piecewise constant path to connect the points. If there are any plot marks, they will be placed on the left open pieces.

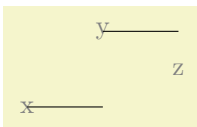

```
\begin{tikzpicture}
\draw[gray] (0,0) node {x} (1,1) node {y} (2,.5) node {z};
\pgfplotstreamjumpmarkleft
\pgfplotstreamstart
\pgfplotstreampoint{\pgfpoint{0cm}{0cm}}
\pgfplotstreampoint{\pgfpoint{1cm}{1cm}}
\pgfplotstreampoint{\pgfpoint{2cm}{0.5cm}}
\pgfplotstreamend
\pgfusepath{stroke}
\end{tikzpicture}
```

### `\pgfplotstreamjumpmarkright`

This handler works like the line-to plot handler, only it will produce a non-connected, piecewise constant path to connect the points. If there are any plot marks, they will be placed on the right open pieces.

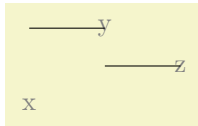

```
\begin{tikzpicture}
\draw[gray] (0,0) node {x} (1,1) node {y} (2,.5) node {z};
\pgfplotstreamstart
\pgfplotstreampoint{\pgfpoint{0cm}{0cm}}
\pgfplotstreampoint{\pgfpoint{1cm}{1cm}}
\pgfplotstreampoint{\pgfpoint{2cm}{0.5cm}}
\pgfplotstreamend
\pgfusepath{stroke}
\end{tikzpicture}
```

### 42.3 Comb Plot Handlers

There are three “comb” plot handlers. Their name stems from the fact that the plots they produce look like “combs” (more or less).

#### `\pgfplotstreamxcomb`

This handler converts each point in the plot stream into a line from the *y*-axis to the point’s coordinate, resulting in a “horizontal comb.”

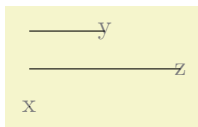

```
\begin{tikzpicture}
\draw[gray] (0,0) node {x} (1,1) node {y} (2,.5) node {z};
\pgfplotstreamxcomb
\pgfplotstreamstart
\pgfplotstreampoint{\pgfpoint{0cm}{0cm}}
\pgfplotstreampoint{\pgfpoint{1cm}{1cm}}
\pgfplotstreampoint{\pgfpoint{2cm}{0.5cm}}
\pgfplotstreamend
\pgfusepath{stroke}
\end{tikzpicture}
```

#### `\pgfplotstreamycomb`

This handler converts each point in the plot stream into a line from the *x*-axis to the point’s coordinate, resulting in a “vertical comb.”

This handler is useful for creating “bar diagrams.”



```
\begin{tikzpicture}
\draw[gray] (0,0) node {x} (1,1) node {y} (2,.5) node {z};
\pgfplotstreamycomb
\pgfplotstreamstart
\pgfplotstreampoint{\pgfpoint{0cm}{0cm}}
\pgfplotstreampoint{\pgfpoint{1cm}{1cm}}
\pgfplotstreampoint{\pgfpoint{2cm}{0.5cm}}
\pgfplotstreamend
\pgfusepath{stroke}
\end{tikzpicture}
```

#### `\pgfplotstreampolarcomb`

This handler converts each point in the plot stream into a line from the origin to the point’s coordinate.

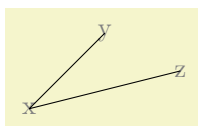

```
\begin{tikzpicture}
\draw[gray] (0,0) node {x} (1,1) node {y} (2,.5) node {z};
\pgfplotstreampolarcomb
\pgfplotstreamstart
\pgfplotstreampoint{\pgfpoint{0cm}{0cm}}
\pgfplotstreampoint{\pgfpoint{1cm}{1cm}}
\pgfplotstreampoint{\pgfpoint{2cm}{0.5cm}}
\pgfplotstreamend
\pgfusepath{stroke}
\end{tikzpicture}
```

PGF bar or comb plots usually draw something from zero to the current plot’s coordinate. The “zero” offset can be changed using an input stream which returns the desired offset successively for each processed coordinate.



There are two such streams, which can be configured independently. The first one returns “zeros” for coordinate  $x$ , the second one returns “zeros” for coordinate  $y$ . They are used as follows.

```
\pgfplotxzerolevelstreamstart
\pgfplotxzerolevelstreamnext % assigns \pgf@x
\pgfplotxzerolevelstreamnext
\pgfplotxzerolevelstreamend
```

```
\pgfplotyzerolevelstreamstart
\pgfplotyzerolevelstreamnext % assigns \pgf@y
\pgfplotyzerolevelstreamend
```

Different zero level streams can be implemented by overwriting these macros.

**\pgfplotxzerolevelstreamconstant**{ $\langle dimension \rangle$ }

This zero level stream always returns  $\langle dimension \rangle$  instead of  $x = 0$ pt. It is used for `xcomb` and `xbar`.

**\pgfplotyzerolevelstreamconstant**{ $\langle dimension \rangle$ }

This zero level stream always returns  $\langle dimension \rangle$  instead of  $y = 0$ pt. It is used for `ycomb` and `ybar`.

## 42.4 Bar Plot Handlers

While comb plot handlers produce a line-to operation to generate combs, bar plot handlers employ rectangular shapes, allowing filled bars (or pattern bars).

**\pgfplothandlerybar**

This handler converts each point in the plot stream into a rectangle from the  $x$ -axis to the point’s coordinate. The rectangle is placed centered at the  $x$ -axis.

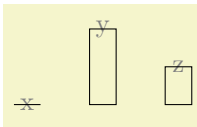

```
\begin{tikzpicture}
\draw[gray] (0,0) node {x} (1,1) node {y} (2,.5) node {z};
\pgfplothandlerybar
\pgfplotstreamstart
\pgfplotstreampoint{\pgfpoint{0cm}{0cm}}
\pgfplotstreampoint{\pgfpoint{1cm}{1cm}}
\pgfplotstreampoint{\pgfpoint{2cm}{0.5cm}}
\pgfplotstreamend
\pgfusepath{stroke}
\end{tikzpicture}
```

**\pgfplothandlerxbar**

This handler converts each point in the plot stream into a rectangle from the  $y$ -axis to the point’s coordinate. The rectangle is placed centered at the  $y$ -axis.

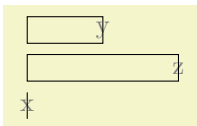

```
\begin{tikzpicture}
\draw[gray] (0,0) node {x} (1,1) node {y} (2,.5) node {z};
\pgfplothandlerxbar
\pgfplotstreamstart
\pgfplotstreampoint{\pgfpoint{0cm}{0cm}}
\pgfplotstreampoint{\pgfpoint{1cm}{1cm}}
\pgfplotstreampoint{\pgfpoint{2cm}{0.5cm}}
\pgfplotstreamend
\pgfusepath{stroke}
\end{tikzpicture}
```

**/pgf/bar width**= $\langle dimension \rangle$   
alias `/tikz/bar width`

(no default, initially 10pt)

Sets the width of `\pgfplothandlerxbar` and `\pgfplothandlerybar` to  $\langle dimension \rangle$ . The argument  $\langle dimension \rangle$  will be evaluated using the math parser.

`/pgf/bar shift={⟨dimension⟩}` (no default, initially 0pt)  
 alias /tikz/bar shift

Sets a shift used by `\pgfplothandlerxbar` and `\pgfplothandlerybar` to `{⟨dimension⟩}`. It has the same effect as `xshift`, but it applies only to those bar plots. The argument `{⟨dimension⟩}` will be evaluated using the math parser.

`\pgfplotbarwidth`

Expands to the value of `/pgf/bar width`.

`\pgfplothandlerybarinterval`

This handler is a variant of `\pgfplothandlerybar` which works with intervals instead of points.

Bars are drawn between successive input coordinates and the width is determined relatively to the interval length.

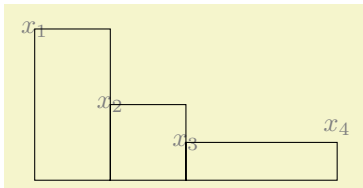

```
\begin{tikzpicture}
  \draw[gray] (0,2) node {$x_1$} (1,1) node {$x_2$} (2,.5) node {$x_3$} (4,0.7) node {$x_4$};
  \pgfplothandlerybarinterval
  \pgfplotstreamstart
  \pgfplotstreampoint{\pgfpoint{0cm}{2cm}}
  \pgfplotstreampoint{\pgfpoint{1cm}{1cm}}
  \pgfplotstreampoint{\pgfpoint{2cm}{0.5cm}}
  \pgfplotstreampoint{\pgfpoint{4cm}{0.7cm}}
  \pgfplotstreamend
  \pgfusepath{stroke}
\end{tikzpicture}
```

In more detail, if  $(x_i, y_i)$  and  $(x_{i+1}, y_{i+1})$  denote successive input coordinates, the bar will be placed above the interval  $[x_i, x_{i+1}]$ , centered at

$$x_i + \langle \text{bar interval shift} \rangle \cdot (x_{i+1} - x_i)$$

with width

$$\langle \text{bar interval width} \rangle \cdot (x_{i+1} - x_i).$$

Here,  $\langle \text{bar interval shift} \rangle$  and  $\langle \text{bar interval width} \rangle$  denote the current values of the associated options.

If you have  $N + 1$  input points, you will get  $N$  bars (one for each interval). The  $y$  value of the last point will be ignored.

`\pgfplothandlerxbarinterval`

As `\pgfplothandlerybarinterval`, this handler provides bar plots with relative bar sizes and offsets, one bar for each  $y$  coordinate interval.

`/pgf/bar interval shift={⟨shift⟩}` (no default, initially 0.5)  
 alias /tikz/bar interval shift

Sets the *relative* shift of `\pgfplothandlerxbarinterval` and `\pgfplothandlerybarinterval` to `{⟨shift⟩}`. As `/pgf/bar interval width`, the argument is relative to the interval length of the input coordinates.

The argument `{⟨scale⟩}` will be evaluated using the math parser.

`/pgf/bar interval width={⟨scale⟩}` (no default, initially 1)  
 alias /tikz/bar interval width

Sets the *relative* width of `\pgfplothandlerxbarinterval` and `\pgfplothandlerybarinterval` to `{⟨scale⟩}`. The argument is relative to  $(x_{i+1} - x_i)$  for  $y$  bar plots and relative to  $(y_{i+1} - y_i)$  for  $x$  bar plots.

The argument  $\langle scale \rangle$  will be evaluated using the math parser.

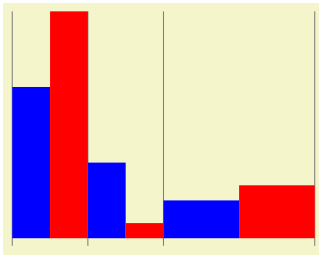

```
\begin{tikzpicture}[bar interval width=0.5]
  \draw[gray]
    (0,3) -- (0,-0.1)
    (1,3) -- (1,-0.1)
    (2,3) -- (2,-0.1)
    (4,3) -- (4,-0.1);
  \pgfplotsandlerybarinterval
  \begin{scope}[bar interval shift=0.25,fill=blue]
    \pgfplotstreamstart
    \pgfplotstreampoint{\pgfpoint{0cm}{2cm}}
    \pgfplotstreampoint{\pgfpoint{1cm}{1cm}}
    \pgfplotstreampoint{\pgfpoint{2cm}{0.5cm}}
    \pgfplotstreampoint{\pgfpoint{4cm}{0.7cm}}
    \pgfplotstreamend
    \pgfusepath{fill}
  \end{scope}
  \begin{scope}[bar interval shift=0.75,fill=red]
    \pgfplotstreamstart
    \pgfplotstreampoint{\pgfpoint{0cm}{3cm}}
    \pgfplotstreampoint{\pgfpoint{1cm}{0.2cm}}
    \pgfplotstreampoint{\pgfpoint{2cm}{0.7cm}}
    \pgfplotstreampoint{\pgfpoint{4cm}{0.2cm}}
    \pgfplotstreamend
    \pgfusepath{fill}
  \end{scope}
\end{tikzpicture}
```

Please note that bars are always centered, so we have to use shifts 0.25 and 0.75 instead of 0 and 0.5.

## 42.5 Mark Plot Handler

`\pgfplotsandlermark` $\langle mark code \rangle$

This command will execute the  $\langle mark code \rangle$  for some points of the plot, but each time the coordinate transformation matrix will be setup such that the origin is at the position of the point to be plotted. This way, if the  $\langle mark code \rangle$  draws a little circle around the origin, little circles will be drawn at some point of the plot.

By default, a mark is drawn at all points of the plot. However, two parameters  $r$  and  $p$  influence this. First, only every  $r$ th mark is drawn. Second, the first mark drawn is the  $p$ th. These parameters can be influenced using the commands below.

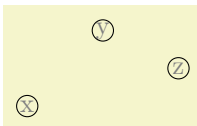

```
\begin{tikzpicture}
  \draw[gray] (0,0) node {x} (1,1) node {y} (2,.5) node {z};
  \pgfplotsandlermark{\pgfpathcircle{\pgfpointorigin}{4pt}\pgfusepath{stroke}}
  \pgfplotstreamstart
  \pgfplotstreampoint{\pgfpoint{0cm}{0cm}}
  \pgfplotstreampoint{\pgfpoint{1cm}{1cm}}
  \pgfplotstreampoint{\pgfpoint{2cm}{0.5cm}}
  \pgfplotstreamend
  \pgfusepath{stroke}
\end{tikzpicture}
```

Typically, the  $\langle code \rangle$  will be `\pgfuseplotmark` $\langle plot mark name \rangle$ , where  $\langle plot mark name \rangle$  is the name of a predefined plot mark.

`\pgfsetplotmarkrepeat` $\langle repeat \rangle$

Sets the  $r$  parameter to  $\langle repeat \rangle$ , that is, only every  $r$ th mark will be drawn.

`\pgfsetplotmarkphase` $\langle phase \rangle$

Sets the  $p$  parameter to  $\langle phase \rangle$ , that is, the first mark to be drawn is the  $p$ th, followed by the  $(p+r)$ th, then the  $(p+2r)$ th, and so on.

`\pgfplotsandlermarklisted` $\langle mark code \rangle$  $\langle index list \rangle$



This command works similar to the previous one. However, marks will only be placed at those indices in the given  $\langle index list \rangle$ . The syntax for the list is the same as for the `\foreach` statement. For



### `\pgfplotmarks`

A TeX dimension that is a “recommendation” for the size of plot marks.

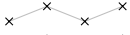
The following plot marks are predefined (the filling color has been set to yellow):

|                                 |                                                                                   |
|---------------------------------|-----------------------------------------------------------------------------------|
| <code>\pgfuseplotmark{*}</code> |  |
| <code>\pgfuseplotmark{x}</code> |  |
| <code>\pgfuseplotmark{+}</code> |  |

## 43 Plot Mark Library

```
\usepgflibrary{plotmarks} %  $\TeX$  and plain  $\TeX$  and pure pgf
\usepgflibrary[plotmarks] % Con $\TeX$ t and pure pgf
\usetikzlibrary{plotmarks} %  $\TeX$  and plain  $\TeX$  when using TikZ
\usetikzlibrary[plotmarks] % Con $\TeX$ t when using TikZ
```

This library defines a number of plot marks.

This library defines the following plot marks in addition to `*`, `x`, and `+` (the filling color has been set to a dark yellow):

|                                         |  |
|-----------------------------------------|--|
| <code>\pgfuseplotmark{-}</code>         |  |
| <code>\pgfuseplotmark{ }</code>         |  |
| <code>\pgfuseplotmark{o}</code>         |  |
| <code>\pgfuseplotmark{asterisk}</code>  |  |
| <code>\pgfuseplotmark{star}</code>      |  |
| <code>\pgfuseplotmark{oplus}</code>     |  |
| <code>\pgfuseplotmark{oplus*}</code>    |  |
| <code>\pgfuseplotmark{otimes}</code>    |  |
| <code>\pgfuseplotmark{otimes*}</code>   |  |
| <code>\pgfuseplotmark{square}</code>    |  |
| <code>\pgfuseplotmark{square*}</code>   |  |
| <code>\pgfuseplotmark{triangle}</code>  |  |
| <code>\pgfuseplotmark{triangle*}</code> |  |
| <code>\pgfuseplotmark{diamond}</code>   |  |
| <code>\pgfuseplotmark{diamond*}</code>  |  |
| <code>\pgfuseplotmark{pentagon}</code>  |  |
| <code>\pgfuseplotmark{pentagon*}</code> |  |
| <code>\pgfuseplotmark{text}</code>      |  |

`/pgf/text mark={\text}` (no default, initially `p`)

Changes the text shown by `mark=text`.

With `/pgf/text mark=m`:

With `/pgf/text mark=A`:

There is no limitation about the number of characters or whatever. In fact, any  $\TeX$  material can be inserted as `{\text}`, including images.

`/pgf/text mark/style={\options for mark=text}` (no default)

Defines a set of options which control the appearance of `mark=text`.

If `/pgf/text mark/as node=false` (the default), `{\options}` is provided as argument to `\pgftext` – which provides only some basic keys like `left`, `right`, `top`, `bottom`, `base` and `rotate`.

If `/pgf/text mark/as node=true`, `{\options}` is provided as argument to `\node`. This means you can provide a very powerful set of options including `anchor`, `scale`, `fill`, `draw`, `rounded corners` etc.

`/pgf/text mark/as node=true|false` (no default, initially `false`)

Configures how `mark=text` will be drawn: either as `\node` or as `\pgftext`.

The first choice is highly flexible and possibly slow, the second is very fast and usually enough.

## 44 Shadings Library

```
\usepgflibrary{shadings} %  $\TeX$  and plain  $\TeX$  and pure pgf
\usepgflibrary[shadings] % Con $\TeX$ t and pure pgf
\usetikzlibrary{shadings} %  $\TeX$  and plain  $\TeX$  when using TikZ
\usetikzlibrary[shadings] % Con $\TeX$ t when using TikZ
```

The package defines a number of shadings in addition to the ball and axis shadings that are available by default.

In the following, the shadings defined in the library are listed in alphabetical order. The colors of some of these shadings can be configured using special options (like `left color`). These options implicitly select the shading.

The three shadings `axis`, `ball`, and `radial` are always defined, even when this library is not used.

### Shading `axis`

In this always-defined shading the colors change gradually between three horizontal lines. The top line is at the top (uppermost) point of the path, the middle is in the middle, the bottom line is at the bottom of the path.

`/tikz/top color=<color>` (no default)

This option prescribes the color to be used at the top in an `axis` shading. When this option is given, several things happen:

1. The `shade` option is selected.
2. The `shading=axis` option is selected.
3. The middle color of the axis shading is set to the average of the given top color `<color>` and of whatever color is currently selected for the bottom.
4. The rotation angle of the shading is set to 0.



```
\tikz \draw[top color=red] (0,0) rectangle (2,1);
```

`/tikz/bottom color=<color>` (no default)

This option works like `top color`, only for the bottom color.

`/tikz/middle color=<color>` (no default)

This option specifies the color for the middle of an axis shading. It also sets the `shade` and `shading=axis` options, but it does not change the rotation angle.

*Note:* Since both `top color` and `bottom color` change the middle color, this option should be given *last* if all of these options need to be given:



```
\tikz \draw[top color=white,bottom color=black,middle color=red]
(0,0) rectangle (2,1);
```

`/tikz/left color=<color>` (no default)

This option does exactly the same as `top color`, except that the shading angle is set to 90°.

`/tikz/right color=<color>` (no default)

Works like `left color`.

### Shading `ball`

This always-defined shading fills the path with a shading that “looks like a ball.” The default “color” of the ball is blue (for no particular reason).

`/tikz/ball color=<color>` (no default)

This option sets the color used for the ball shading. It sets the `shade` and `shading=ball` options. Note that the ball will never “completely” have the color `<color>`. At its “highlight” spot a certain amount of white is mixed in, at the border a certain amount of black. Because of this, it also makes sense to say `ball color=white` or `ball color=black`

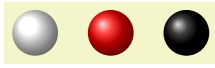

```
\begin{tikzpicture}
  \shade[ball color=white] (0,0) circle (2ex);
  \shade[ball color=red] (1,0) circle (2ex);
  \shade[ball color=black] (2,0) circle (2ex);
\end{tikzpicture}
```

### Shading `bilinear interpolation`

This shading fills a rectangle with colors that are bilinearly interpolated between the colors in the four corners of the rectangle. These four colors are called `lower left`, `lower right`, `upper left`, and `upper right`. By changing these colors, you can change the way the shading looks. The library also defines four options, called the same way, that can be used to set these colors and select the shading implicitly.

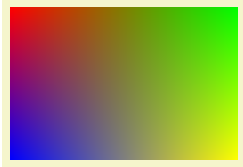

```
\tikz
  \shade[upper left=red,upper right=green,
        lower left=blue,lower right=yellow]
    (0,0) rectangle (3,2);
```

`/tikz/lower left=<color>` (no default, initially `white`)

Sets the color to be used in a `bilinear interpolation` shading for the lower left corner. Also, this option selects this shading and sets the `shade` option.

`/tikz/upper left=<color>` (no default, initially `white`)

Like `lower left`.

`/tikz/upper right=<color>` (no default, initially `white`)

Like `lower left`.

`/tikz/lower right=<color>` (no default, initially `white`)

Like `lower left`.

### Shading `color wheel`

This shading fills the path with a color wheel.

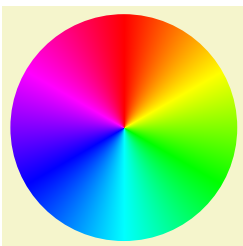

```
\tikz \shade[shading=color wheel] (0,0) circle (1.5);
```

To produce a color ring, cut out a circle from the color wheel:

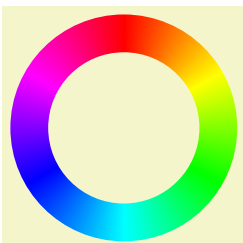

```
\tikz \shade[shading=color wheel] [even odd rule]
  (0,0) circle (1.5)
  (0,0) circle (1);
```



### Shading `color wheel black center`

This shading looks like a color wheel, but the brightness drops to zero in the center.

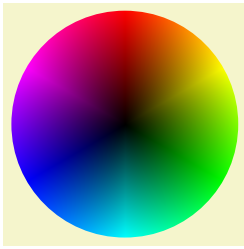

```
\tikz \shade[shading=color wheel black center] (0,0) circle (1.5);
```

### Shading `color wheel white center`

This shading looks like a color wheel, but the saturation drops to zero in the center.



```
\tikz \shade[shading=color wheel white center] (0,0) circle (1.5);
```

### Shading `Mandelbrot set`

This shading is just for fun. It fills the path with a zoomable Mandelbrot set.

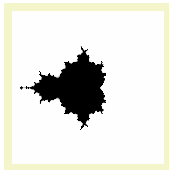

```
\tikz \shade[shading=Mandelbrot set] (0,0) rectangle (2,2);
```

### Shading `radial`

This always-defined shading fills the path with a gradual sweep from a certain color in the middle to another color at the border. If the path is a circle, the outer color will be reached exactly at the border. If the shading is not a circle, the outer color will continue a bit towards the corners. The default inner color is gray, the default outer color is white.

`/tikz/inner color=<color>` (no default)

This option sets the color used at the center of a `radial` shading. When this option is used, the `shade` and `shading=radial` options are set.



```
\tikz \draw[inner color=red] (0,0) rectangle (2,1);
```

`/tikz/outer color=<color>` (no default)

This option sets the color used at the border and outside of a `radial` shading.



```
\tikz \draw[outer color=red,inner color=white] (0,0) rectangle (2,1);
```

## 45 Shadow Library

```
\usepgflibrary{shadows} %  $\LaTeX$  and plain  $\TeX$  and pure pgf
\usepgflibrary[shadows] % Con $\TeX$ t and pure pgf
\usetikzlibrary{shadows} %  $\LaTeX$  and plain  $\TeX$  when using TikZ
\usetikzlibrary[shadows] % Con $\TeX$ t when using TikZ
```

This library defines styles that help adding a (partly) transparent shadow to a path or node.

### 45.1 Overview

A *shadow* is usually a black or gray area that is drawn behind a path or a node, thereby adding visual depth to a picture. The shadows library defines options that make it easy to add shadows to paths. Internally, these options are based on using the `preaction` option to use a path twice: Once for drawing the shadow (slightly shifted) and once for actually using the path.

Note that you can only add shadows to *paths*, not to whole scopes.

In addition to the general `shadow` option, there exist special options like `circular shadow`. These can only (sensibly) be used with a special kind of path (for `circular shadow`, a circle) and, thus, there are not as general. The advantage is, however, that they are more visually pleasing since these shadows blend smoothly with the background. Note that these special shadows use *fadings*, which few printers will support.

### 45.2 The General Shadow Option

The shadows are internally created by using a single option called `general shadow`. The different options like `drop shadow` or `copy shadow` only differ in the commands that they preset.

You will not need to use this option directly under normal circumstances.

`/tikz/general shadow=<shadow options>` (default empty)

This option should be given to a `\path` or a `node`. It has the following effect: Before the path is used normally, it is used once with the `<shadow options>` in force. Furthermore, when the path is “preused” in this way, it is shifted and scaled a little bit.

In detail, the following happens: A `preaction` is used to paint the path in a special manner before it is actually painted. This “special” manner is as follows: The options in `<shadow options>` are used for painting this path. Typically, the `<shadow options>` will contain options like `fill=black` to create, say, a black shadow. Furthermore, after the `<shadow options>` have been setup, the following extra canvas transformations are applied to the path: It is scaled by `shadow scale` (with the origin of scaling at the path’s center) and it is shifted by `shadow xshift` and `shadow yshift`.

Note that since scaling and shifting is done using canvas transformations, shadows are not taken into account when the picture’s bounding box is computed.

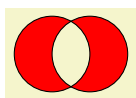

```
\tikz [even odd rule]
\draw [general shadow={fill=red}] (0,0) circle (.5) (0.5,0) circle (.5);
```

`/tikz/shadow scale=<factor>` (no default, initially 1)

Shadows are scaled by this amount.

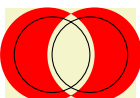

```
\tikz [even odd rule]
\draw [general shadow={fill=red,shadow scale=1.25}]
(0,0) circle (.5) (0.5,0) circle (.5);
```

`/tikz/shadow xshift=<factor>` (no default, initially 0pt)

Shadows are shifted horizontally by this amount.

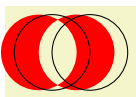

```
\tikz [even odd rule]
\draw [general shadow={fill=red,shadow xshift=-5pt}]
(0,0) circle (.5) (0.5,0) circle (.5);
```

`/tikz/shadow yshift=<factor>`

(no default, initially Opt)

Shadows are shifted vertically by this amount.

## 45.3 Shadows for Arbitrary Paths and Shapes

### 45.3.1 Drop Shadows

`/tikz/drop shadow=<shadow options>`

(default empty)

This option adds a drop shadow to a path or node. `\path` or a node. It uses the `general shadow` and passes the `<shadow options>` to it plus, before them, the following extra options:

```
shadow scale=1, shadow xshift=.5ex, shadow yshift=-.5ex,
opacity=.5, fill=black!50, every shadow
```

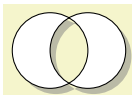

```
\tikz [even odd rule]
\filldraw [drop shadow,fill=white] (0,0) circle (.5) (0.5,0) circle (.5);
```

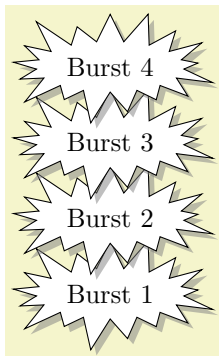

```
\begin{tikzpicture}
\foreach \i in {1,...,4}
\node[starburst,drop shadow,fill=white,draw] at (0,\i) {Burst \i};
\end{tikzpicture}
```

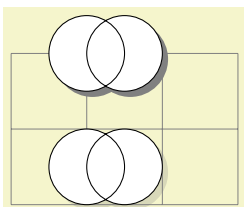

```
\begin{tikzpicture}
\draw [help lines] (0,0) grid (3,2);
\filldraw [drop shadow={opacity=0.25},fill=white]
(1,.5) circle (.5) (1.5,.5) circle (.5);

\filldraw [drop shadow={opacity=1},fill=white]
(1,2) circle (.5) (1.5,2) circle (.5);
\end{tikzpicture}
```

`/tikz/every shadow`

(style, initially empty)

This style is executed in addition to any `<shadow options>` for each shadow. Use this style to reconfigure the way shadows are drawn.

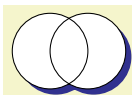

```
\begin{tikzpicture}[every shadow/.style={opacity=.8,fill=blue!50!black}]
\filldraw [drop shadow,fill=white] (0,0) circle (.5) (0.5,0) circle (.5);
\end{tikzpicture}
```

### 45.3.2 Copy Shadows

A *copy shadow* is not really a shadow. Rather, it looks like another copy of the path drawn behind the path and a little bit offset. This creates the visual impression of having multiple copies of the path/object present.

`/tikz/copy shadow=<shadow options>`

(default empty)

This shadow installs the following default options:

```
shadow scale=1, shadow xshift=.5ex, shadow yshift=-.5ex, every shadow
```

Furthermore, the options `fill=<fill color>` and `draw=<draw color>` are also set, where the *<fill color>* and *<draw color>* are the fill and draw colors used for the main path.



```

\begin{tikzpicture}
  \node [copy shadow,fill=blue!20,draw=blue,thick] {Hello World!};

  \node at (0,-1) [copy shadow={shadow xshift=1ex,shadow yshift=1ex},
    fill=blue!20,draw=blue,thick]
    {Hello World!};

  \node at (0,-2) [copy shadow={opacity=.5},tape,
    fill=blue!20,draw=blue,thick]
    {Hello World!};

  % We have to repeat the left color since shadings are not
  % automatically applied to shadows
  \node at (0,-3) [copy shadow={left color=blue!50},
    left color=blue!50,draw=blue,thick]
    {Hello World!};
\end{tikzpicture}

```

`/tikz/double copy shadow=<shadow options>` (default empty)

This shadow works like a `copy shadow`, only the shadow is added twice, the first time with the double `xshift` and `yshift`.



```

\begin{tikzpicture}
  \node [double copy shadow,fill=blue!20,draw=blue,thick] {Hello World!};

  \node at (0,-1) [double copy shadow={shadow xshift=1ex,shadow yshift=1ex},
    fill=blue!20,draw=blue,thick]
    {Hello World!};

  \node at (0,-2) [double copy shadow={opacity=.5},tape,
    fill=blue!20,draw=blue,thick]
    {Hello World!};

  \node at (0,-3) [double copy shadow={left color=blue!50},
    left color=blue!50,draw=blue,thick]
    {Hello World!};
\end{tikzpicture}

```

## 45.4 Shadows for Special Paths and Nodes

The shadows in this section should normally be added only to paths that have a special shape. They will look strange with other shapes.

`/tikz/circular drop shadow=<shadow options>` (no default)

This shadow works like a drop shadow, only it adds a circular fading to the shadow. This means that the shadow will fade out at the border. The following options are preset for this shadow:

```

shadow scale=1.1, shadow xshift=.3ex, shadow yshift=-.3ex,
fill=black, path fading={circle with fuzzy edge 15 percent},
every shadow,

```

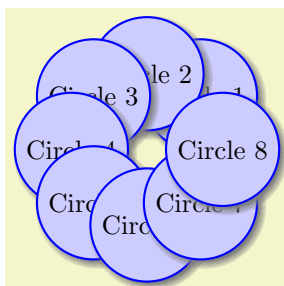

```

\begin{tikzpicture}
  \foreach \i in {1,...,8}
    \node[circle,circular drop shadow,draw=blue,fill=blue!20,thick]
      at (\i*45:1) {Circle \i};
\end{tikzpicture}

```

`/tikz/circular glow=<shadow options>`

(no default)

This shadow works much like the `circular shadow`, only it is not shifted. This creates a visual effect of a “glow” behind the circle. The following options are preset for this shadow:

```
shadow scale=1.25, shadow xshift=0pt, shadow yshift=0pt,  
fill=black, path fading={circle with fuzzy edge 15 percent},  
every shadow,
```

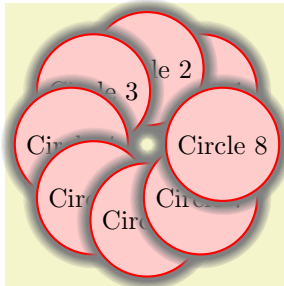

```
\begin{tikzpicture}  
  \foreach \i in {1,...,8}  
  \node[circle,circular glow,fill=red!20,draw=red,thick]  
  at (\i*45:1) {Circle \i};  
\end{tikzpicture}
```

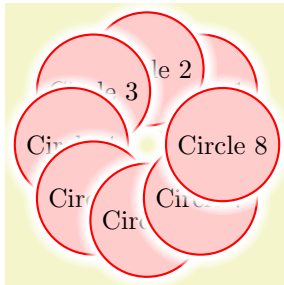

```
\begin{tikzpicture}  
  \foreach \i in {1,...,8}  
  \node[circle,circular glow={fill=white},fill=red!20,draw=red,thick]  
  at (\i*45:1) {Circle \i};  
\end{tikzpicture}
```

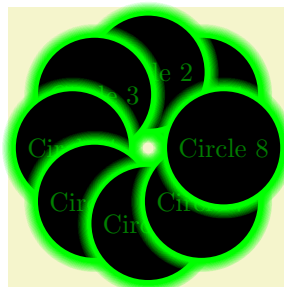

```
\begin{tikzpicture}  
  \foreach \i in {1,...,8}  
  \node[circle,circular glow={fill=green},fill=black,text=green!50!black]  
  at (\i*45:1) {Circle \i};  
\end{tikzpicture}
```

An especially interesting effect can be achieved by only using the glow and not filling the path:

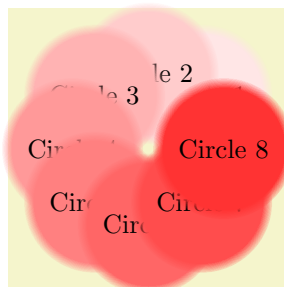

```
\begin{tikzpicture}  
  \foreach \i in {1,...,8}  
  \node[circle,circular glow={fill=red!\i0}]  
  at (\i*45:1) {Circle \i};  
\end{tikzpicture}
```

## 46 Shape Library

### 46.1 Overview

In addition to the standard shapes `rectangle`, `circle` and `coordinate`, there exist a number of additional shapes defined in different shape libraries. Most of these shapes have been contributed by Mark Wibrow. In the present section, these shapes are described. Note that the library `shapes` is provided for compatibility only. Please include sublibraries like `shapes.geometric` or `shapes.misc` directly.

The appearance of shapes is influenced by numerous parameters like `minimum height` or `inner xsep`. These general parameters are documented in Section 16.2.2

### 46.2 Predefined Shapes

The three shapes `rectangle`, `circle`, and `coordinate` are always defined and no library needs to be loaded for them. While the `coordinate` shape defines only the `center` anchor, the other two shapes define a standard set of anchors.

#### Shape `circle`

This shape draws a tightly fitting circle around the text. The following figure shows the anchors this shape defines; the anchors `10` and `130` are example of border anchors.

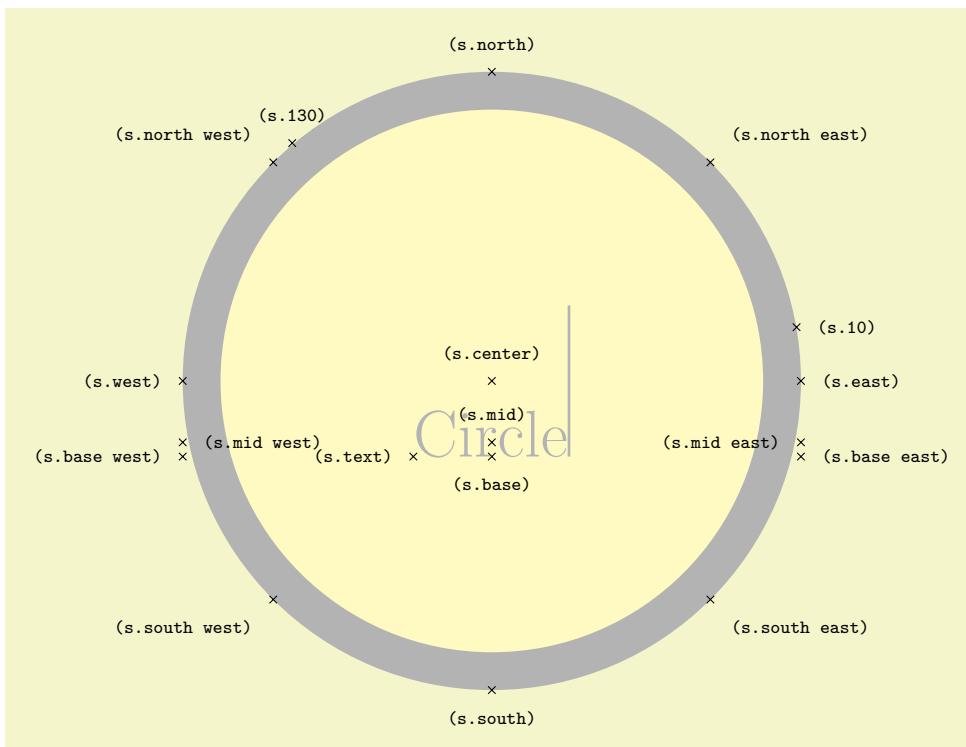

```
\Huge
\begin{tikzpicture}
\node[name=s,shape=circle,shape example] {Circle\vrule width 1pt height 2cm};
\foreach \anchor/\placement in
{north west/above left, north/above, north east/above right,
west/left, center/above, east/right,
mid west/right, mid/above, mid east/left,
base west/left, base/below, base east/right,
south west/below left, south/below, south east/below right,
text/left, 10/right, 130/above}
\draw[shift=(s.\anchor)] plot[mark=x] coordinates{(0,0)}
node[\placement] {\scriptsize\texttt{(s.\anchor)}};
\end{tikzpicture}
```

#### Shape `rectangle`

This shape, which is the standard, is a rectangle around the text. The inner and outer separations (see Section 16.2.2) influence the white space around the text. The following figure shows the anchors this shape defines; the anchors 10 and 130 are example of border anchors.

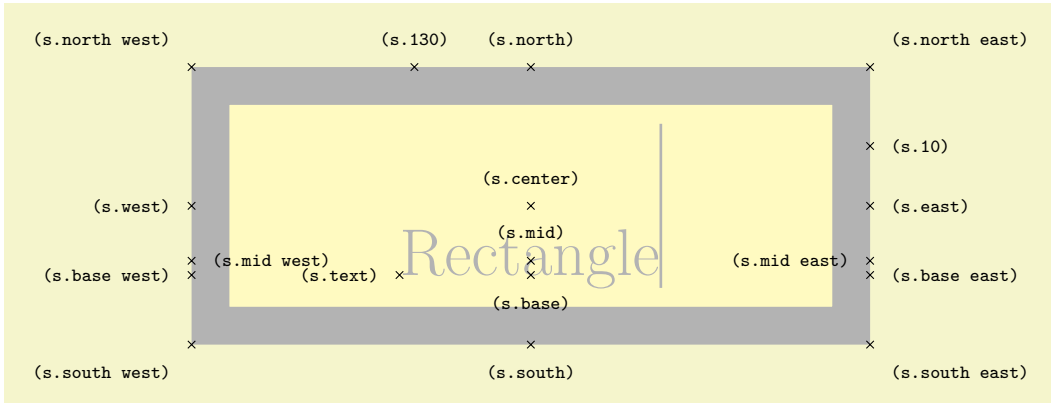

```

\Huge
\begin{tikzpicture}
\node[name=s,shape=rectangle,shape example] {Rectangle\vrule width 1pt height 2cm};
\foreach \anchor/\placement in
{north west/above left, north/above, north east/above right,
west/left, center/above, east/right,
mid west/right, mid/above, mid east/left,
base west/left, base/below, base east/right,
south west/below left, south/below, south east/below right,
text/left, 10/right, 130/above}
\draw[shift=(s.\anchor)] plot[mark=x] coordinates{(0,0)}
node[\placement] {\scriptsize\texttt{(s.\anchor)}};
\end{tikzpicture}

```

### 46.3 Geometric Shapes

```

\usepgflibrary{shapes.geometric} %  $\TeX$  and plain  $\TeX$  and pure pgf
\usepgflibrary[shapes.geometric] % Con $\TeX$ t and pure pgf
\usetikzlibrary{shapes.geometric} %  $\TeX$  and plain  $\TeX$  when using TikZ
\usetikzlibrary[shapes.geometric] % Con $\TeX$ t when using TikZ

```

This library defines different shapes that correspond to basic geometric objects like ellipses or polygons.

#### Shape `diamond`

This shape is a diamond tightly fitting the text box. The ratio between width and height is 1 by default, but can be changed by setting the shape aspect ratio using the following PGF key (to use this key in TikZ simply remove the `/pgf/` path).

`/pgf/aspect=value` (no default, initially 1.0)

The aspect is a recommendation for the quotient of the width and the height of a shape. This key calls the macro `\pgfsetshapeaspect`.

The following figure shows the anchors this shape defines; the anchors 10 and 130 are example of border anchors.

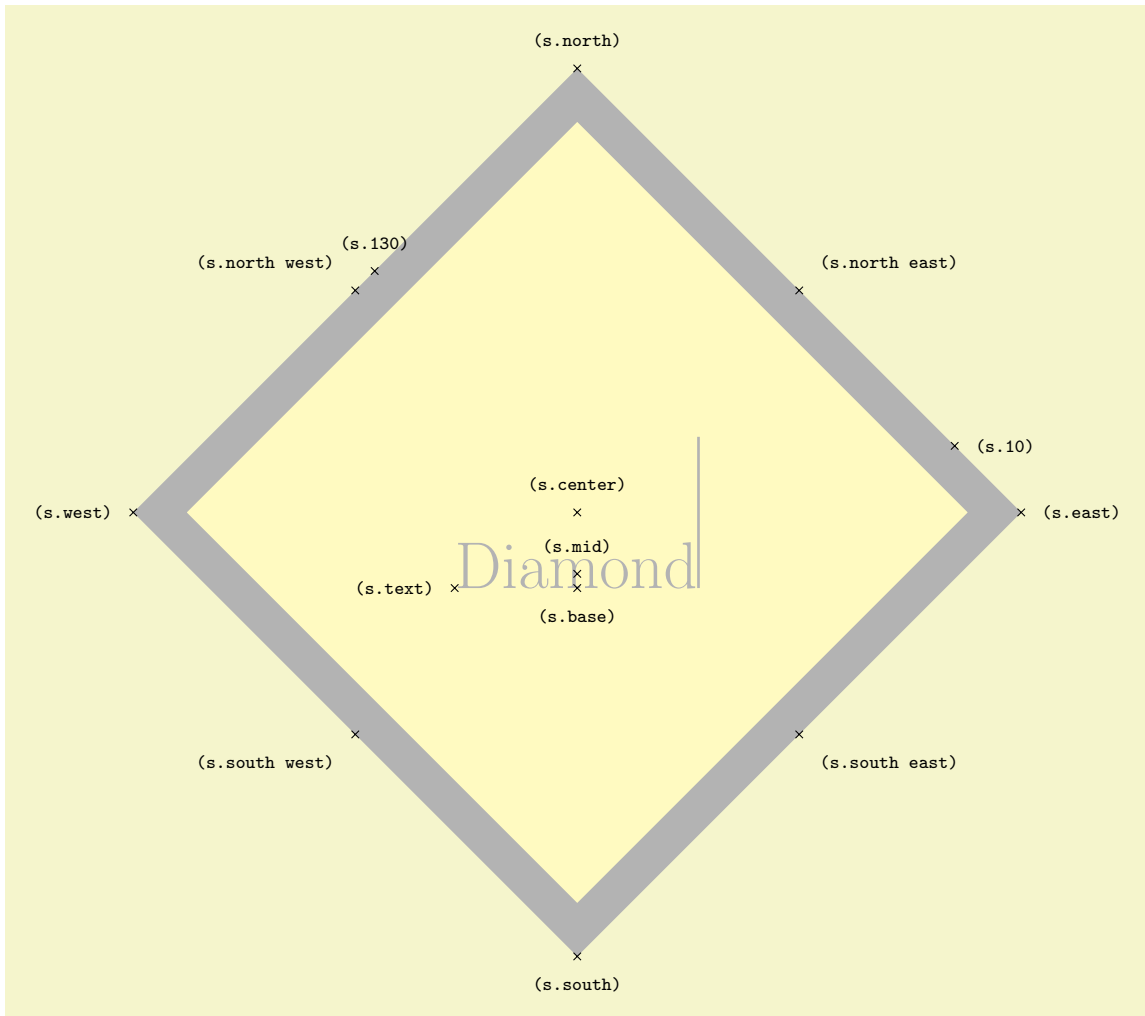

```

\Huge
\begin{tikzpicture}
  \node[name=s,shape=diamond,shape example] {Diamond\vrule width 1pt height 2cm};
  \foreach \anchor/\placement in
    {north west/above left, north east/above right,
     west/left, center/above, east/right,
     mid/above,
     base/below,
     south west/below left, south/below, south east/below right,
     text/left, 10/right, 130/above}
    \draw[shift=(s.\anchor)] plot[mark=x] coordinates{(0,0)}
      node[\placement] {\scriptsize\texttt{(s.\anchor)}};
\end{tikzpicture}

```

### Shape **ellipse**

This shape is an ellipse tightly fitting the text box, if no inner separation is given. The following figure shows the anchors this shape defines; the anchors 10 and 130 are example of border anchors.



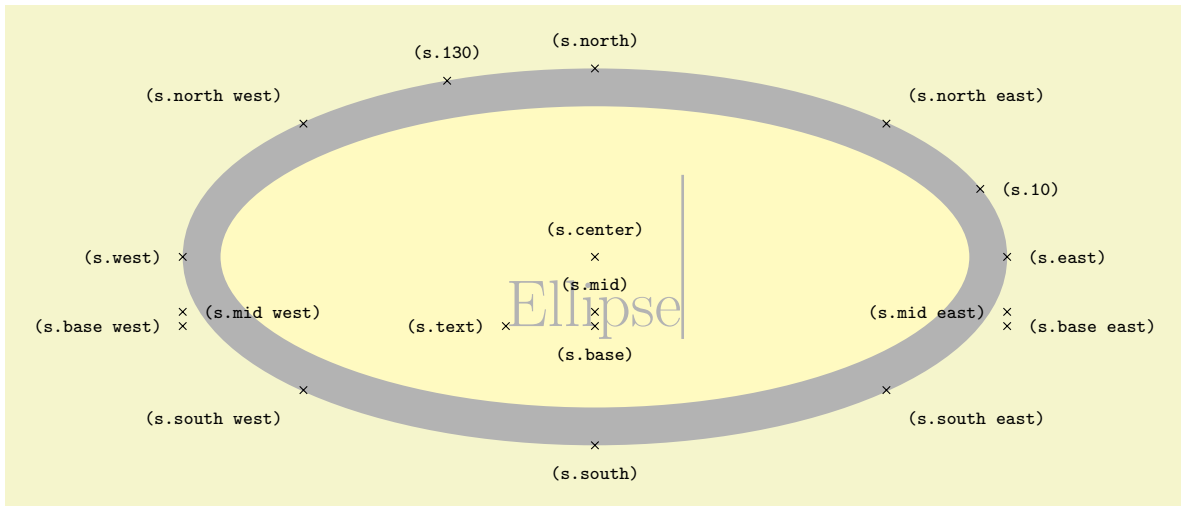

```

\Huge
\begin{tikzpicture}
  \node[name=s,shape=ellipse,shape example] {Ellipse\vrule width 1pt height 2cm};
  \foreach \anchor/\placement in
  {north west/above left, north east/above right,
  west/left, center/above, east/right,
  mid west/right, mid/above, mid east/left,
  base west/left, base/below, base east/right,
  south west/below left, south/below, south east/below right,
  text/left, 10/right, 130/above}
  \draw[shift=(s.\anchor)] plot[mark=x] coordinates{(0,0)}
  node[\placement] {\scriptsize\texttt{(s.\anchor)}};
\end{tikzpicture}

```

### Shape **trapezium**

This shape is a trapezium, that is, a quadrilateral with a single pair of parallel lines (this can sometimes be known as a trapezoid). The trapezium shape supports the rotation of the shape border, as described in Section 16.2.2.

The lower internal angles at the lower corners of the trapezium can be specified independently, and the resulting extensions are in addition to the natural dimensions of the node contents (which includes any inner sep).

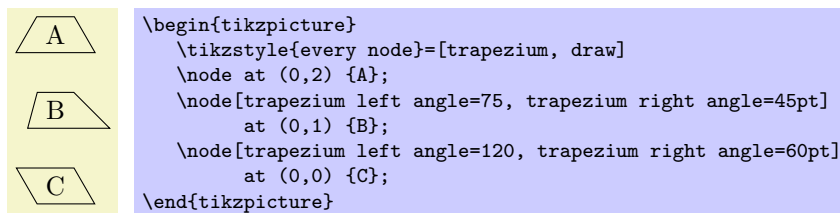

The PGF keys to set the lower internal angles of the trapezium are shown below. To use these keys in TikZ, simply remove the `/pgf/` path.

`/pgf/trapezium left angle=angle` (no default, initially 60)

Set the lower internal angle of the left side.

`/pgf/trapezium right angle=angle` (no default, initially 60)

Set the lower internal angle of the right side.

`/pgf/trapezium angle=angle` (style, no default)

This key stores no value itself, but sets the value of the previous two keys to *angle*.

Regardless of the rotation of the shape border, the width and height of the trapezium are as follows:

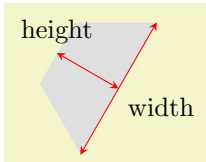

```
\begin{tikzpicture}[>=stealth, every node/.style={text=black},
  shape border uses incircle, shape border rotate=60]
  \node [trapezium, fill=gray!25, minimum width=2cm] (t) {};
  \draw [red, <->] (t.bottom left corner) -- (t.bottom right corner)
  node [midway, below right] {width};
  \draw [red, <->] (t.top side) -- (t.bottom side)
  node [at start, above] {height};
\end{tikzpicture}
```

`/pgf/trapezium stretches=<boolean>` (default true)

This key controls whether PGF allows the width and the height of the trapezium to be enlarged independently, when considering any minimum size specification. This is initially `false`, ensuring that the shape “looks the same but bigger” when enlarged.

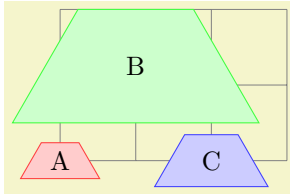

```
\tikzset{my node/.style={trapezium, fill=#1!20, draw=#1!75, text=black}}
\begin{tikzpicture}
  \draw [help lines] grid (3,2);
  \node [my node=red] {A};
  \node [my node=green, minimum height=1.5cm] at (1, 1.25) {B};
  \node [my node=blue, minimum width=1.5cm] at (2, 0) {C};
\end{tikzpicture}
```

By setting `<boolean>` to true, the trapezium can be stretched horizontally or vertically.

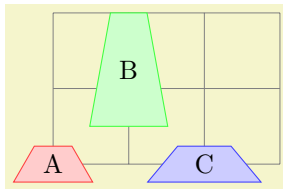

```
\tikzset{my node/.style={trapezium, fill=#1!20, draw=#1!75, text=black}}
\begin{tikzpicture}
  \tikzset{trapezium stretches=true}
  \draw [help lines] grid (3,2);
  \node [my node=red] {A};
  \node [my node=green, minimum height=1.5cm] at (1, 1.25) {B};
  \node [my node=blue, minimum width=1.5cm] at (2, 0) {C};
\end{tikzpicture}
```

`/pgf/trapezium stretches body=<boolean>` (default true)

This is similar to the `trapezium stretches` key except that when `<boolean>` is true, PGF enlarges only the body of the trapezium when applying minimum width.

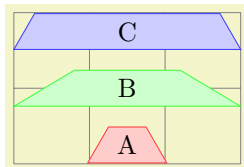

```
\tikzset{my node/.style={trapezium, fill=#1!20, draw=#1!75, text=black}}
\begin{tikzpicture}
  \draw [help lines] grid (3,2);
  \node [my node=red] at (1.5,.25) {A};
  \node [my node=green, minimum width=3cm, trapezium stretches]
  at (1.5,1) {B};
  \node [my node=blue, minimum width=3cm, trapezium stretches body]
  at (1.5,1.75) {C};
\end{tikzpicture}
```

The anchors for the trapezium are shown below. The anchor `160` is an example of a border anchor.

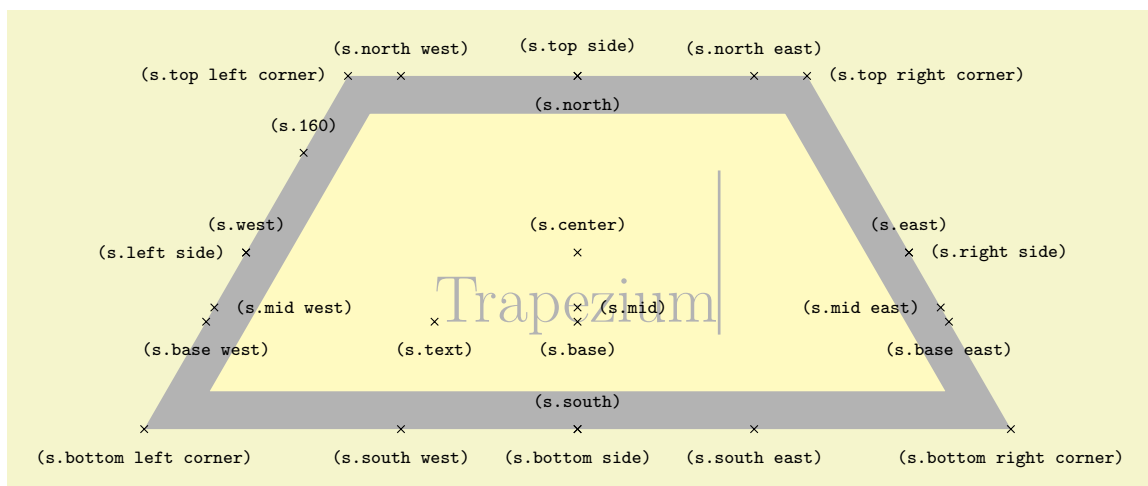

```

\Huge
\begin{tikzpicture}
  \node[name=s, shape=trapezium, shape example, inner sep=1cm]
    {Trapezium\vrule width 1pt height 2cm};
  \foreach \anchor/\placement in
    {bottom left corner/below, top right corner/right,
     top left corner/left,    bottom right corner/below,
     bottom side/below,      left side/left,
     right side/right,       top side/above,
     center/above,    text/below,    mid/right,    base/below,
     mid west/right, base west/below, mid east/left,  base east/below,
     west/above,    east/above,    north/below,    south/above,
     north west/above, north east/above,
     south west/below, south east/below, 160/above}
    \draw[shift=(s.\anchor)] plot[mark=x] coordinates{(0,0)}
      node[\placement] {\scriptsize\texttt{(s.\anchor)}};
\end{tikzpicture}

```

### Shape `semicircle`

This shape is a semicircle, which tightly fits the node contents. This shape supports the rotation of the shape border, as described in Section 16.2.2. The anchors for the `semicircle` shape are shown below. Anchor 30 is an example of a border anchor.

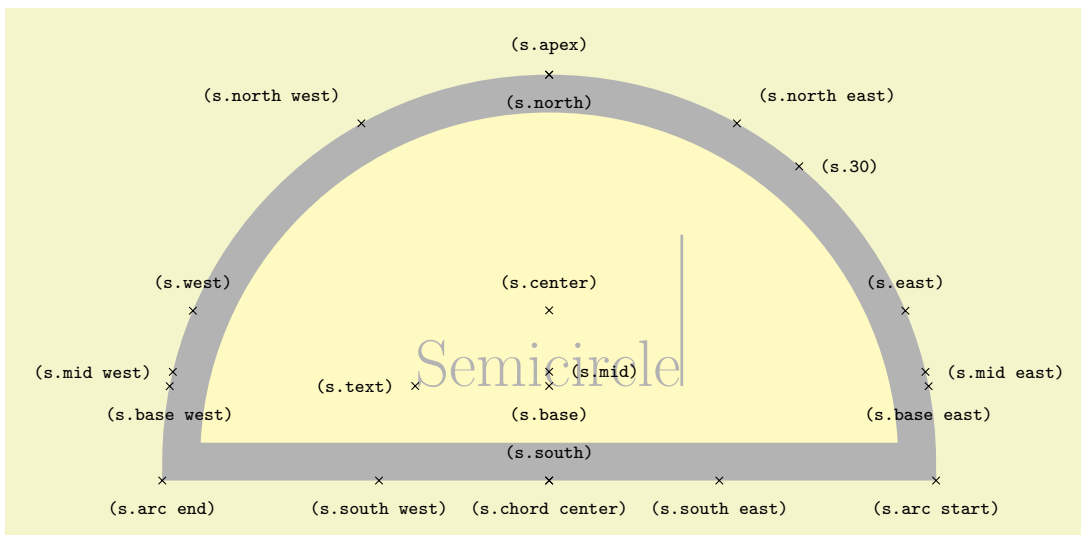

```

\Huge
\begin{tikzpicture}
  \node[name=s, shape=semicircle, shape border rotate=0, shape example, inner sep=1cm]
    {Semicircle\vrule width 1pt height 2cm};
  \foreach \anchor/\placement in
    {apex/above,    arc start/below, arc end/below,    chord center/below,
     center/above,  base/below,    mid/right,    text/left,
     base west/below, base east/below, mid west/left, mid east/right,
     north/below,    south/above,    east/above,    west/above,
     north west/above left, north east/above right,
     south west/below,    south east/below, 30/right}
    \draw[shift=(s.\anchor)] plot[mark=x] coordinates{(0,0)}
      node[\placement] {\scriptsize\texttt{(s.\anchor)}};
\end{tikzpicture}

```

### Shape `regular polygon`

This shape is a regular polygon, which, by default, is drawn so that a side (rather than a corner) is always at the bottom. This shape supports the rotation as described in Section 16.2.2, but the border of the polygon is *always* constructed using the `incircle`, whose radius is calculated to tightly fit the node contents (including any `inner sep`).

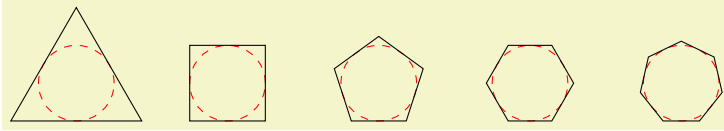

```

\begin{tikzpicture}
  \foreach \a in {3,...,7}{
    \draw[red, dashed] (\a*2,0) circle(0.5cm);
    \node[regular polygon, regular polygon sides=\a, draw,
      inner sep=0.3535cm] at (\a*2,0) {};
  }
\end{tikzpicture}

```

If the node is enlarged to any specified minimum size, this is interpreted as the diameter of the the circumscribed circle, that is, the circle that passes through all the corners of the polygon border.

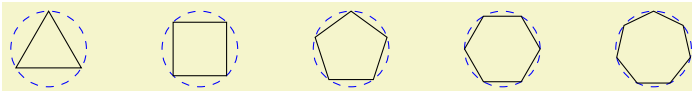

```

\begin{tikzpicture}
  \foreach \a in {3,...,7}{
    \draw[blue, dashed] (\a*2,0) circle(0.5cm);
    \node[regular polygon, regular polygon sides=\a, minimum size=1cm, draw] at (\a*2,0) {};
  }
\end{tikzpicture}

```

There is a PGF key to set the number of sides for the regular polygon. To use this key in *TikZ*, simply remove the `/pgf/` path.

`/pgf/regular polygon sides=integer` (no default, initially 5)

The anchors for a regular polygon shape are shown below. The anchor `75` is an example of a border anchor.

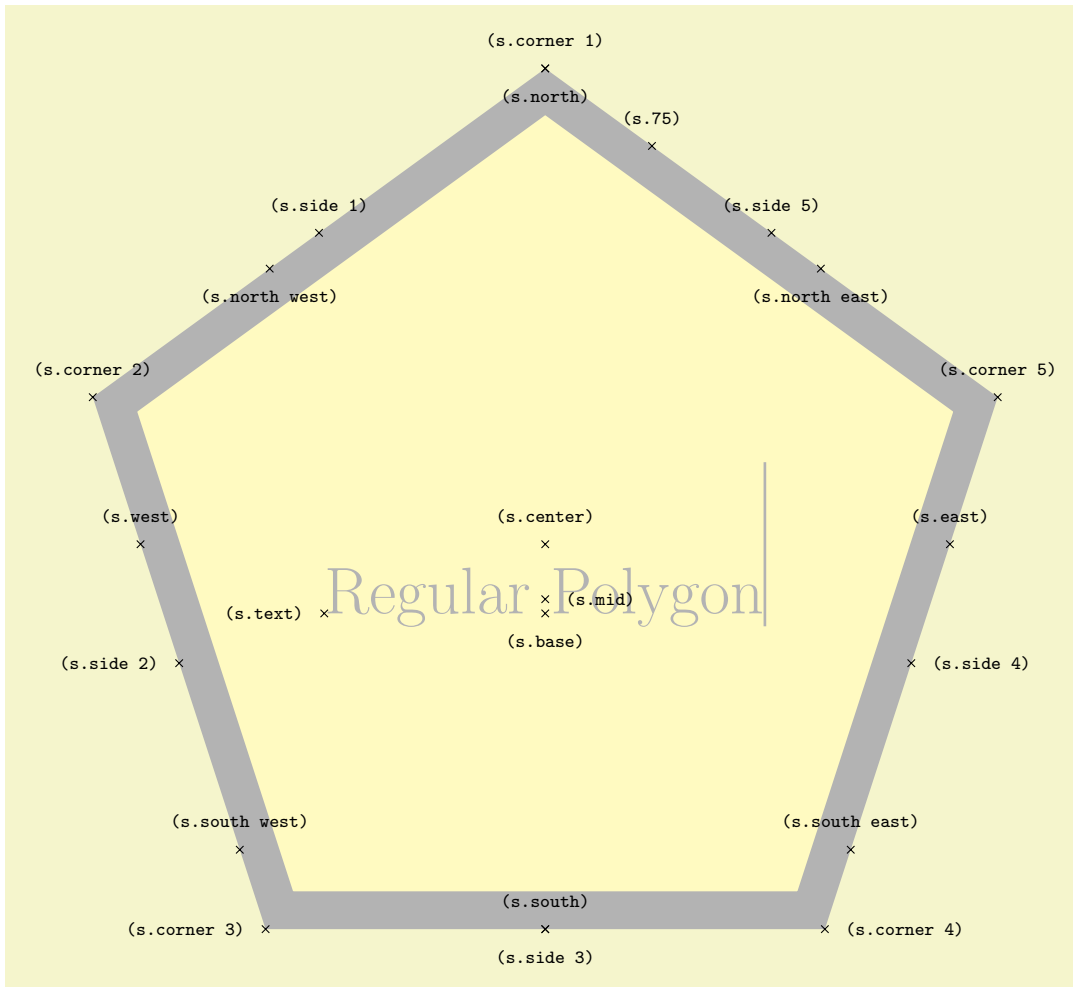

```

\Huge
\begin{tikzpicture}
  \node[name=s, shape=regular polygon, shape example, inner sep=.5cm]
  {Regular Polygon\vrule width 1pt height 2cm};
  \foreach \anchor/\placement in
  {corner 1/above, corner 2/above, corner 3/left, corner 4/right, corner 5/above,
  side 1/above, side 2/left, side 3/below, side 4/right, side 5/above,
  center/above, text/left, mid/right, base/below, 75/above,
  west/above, east/above, north/below, south/above,
  north east/above, north west/below, south west/above}
  \draw[shift=(s.\anchor)] plot[mark=x] coordinates{(0,0)}
  node[\placement] {\scriptsize\texttt{(s.\anchor)}};
\end{tikzpicture}

```

### Shape `star`

This shape is a star, which by default (minus any transformations) is drawn with the first point pointing upwards. This shape supports the rotation as described in Section 16.2.2, but the border of the star is *always* constructed using the incircle.

A star should be thought of as having an set of “inner points” and and “outer points”. The inner points of the border are based on the radius of the circle which tightly fits the node contents, and the outer points are based on the circumcircle, the circle that passes through every outer point. Any specified minimum size, width or height, is interpreted as the diameter of the circumcircle.

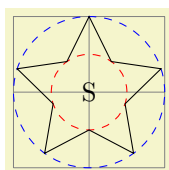

```

\begin{tikzpicture}
  \draw [help lines] (0,0) grid (2,2);
  \draw [blue, dashed] (1,1) circle(1cm);
  \draw [red, dashed] (1,1) circle(.5cm);
  \node [star, star point height=.5cm, minimum size=2cm, draw]
  at (1,1) {S};
\end{tikzpicture}

```

The PGF keys to set the number of star points, and the height of the star points, are shown below. To use these keys in TikZ, simply remove the `/pgf/` path.

`/pgf/star points=<integer>` (no default, initially 5)

Sets the number of points for the star.

`/pgf/star point height=<distance>` (no default, initially .5cm)

Sets the height of the star points. This is the distance between the inner point and outer point radii. If the star is enlarged to some specified minimum size, the inner radius is increased to maintain the point height.

`/pgf/star point ratio=<number>` (no default, initially 1.5)

Sets the ratio between the inner point and outer point radii. If the star is enlarged to some specified minimum size, the inner radius is increased to maintain the ratio.

The inner and outer points form the principle anchors for the star, as shown below (anchor 75 is an example of a border anchor).

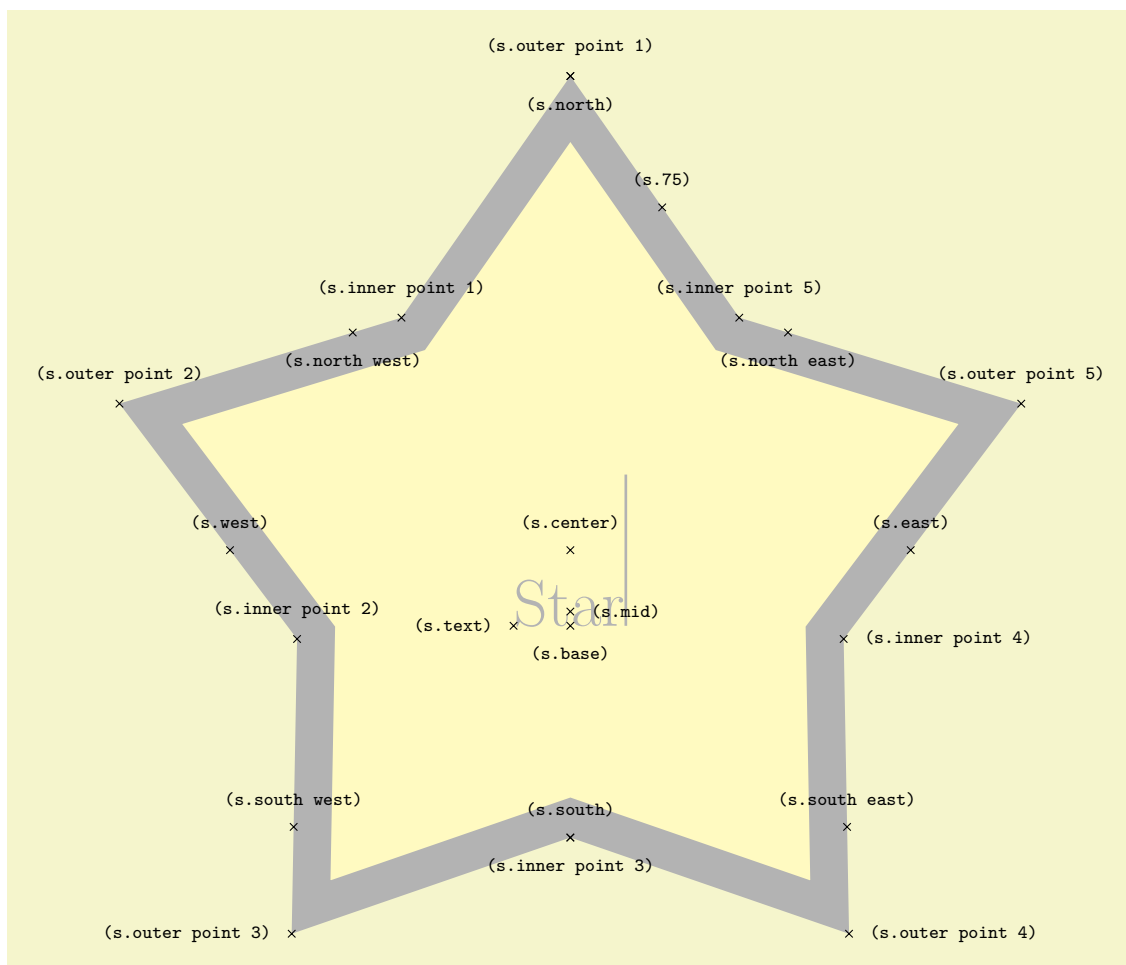

```
\Huge
\begin{tikzpicture}
  \node[name=s, shape=star, star points=5, star point ratio=1.65, shape example, inner sep=1.5cm]
  {Star\vrule width 1pt height 2cm};
  \foreach \anchor/\placement in
  {inner point 1/above, inner point 2/above, inner point 3/below, inner point 4/right,
  inner point 5/above, outer point 1/above, outer point 2/above, outer point 3/left,
  outer point 4/right, outer point 5/above,
  center/above, text/left, mid/right, base/below, 75/above,
  west/above, east/above, north/below, south/above,
  north east/below, south east/above, north west/below, south west/above}
  \draw[shift=(s.\anchor)] plot[mark=x] coordinates{(0,0)}
  node[\placement] {\scriptsize\texttt{(s.\anchor)}};
\end{tikzpicture}
```

## Shape `isosceles triangle`

This shape is an isosceles triangle, which supports the rotation of the shape border, as described in Section 16.2.2. The angle of rotation determines the direction in which the apex of the triangle points (provided no other transformations are applied). However, regardless of the rotation of the shape border, the width and height are always considered as follows:

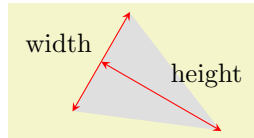

```
\begin{tikzpicture}[>=stealth, every node/.style={text=black},
  shape border uses incircle, shape border rotate=-30]
  \node [isosceles triangle, fill=gray!25, minimum width=1.5cm] (t) {};
  \draw [red, <->] (t.left corner) -- (t.right corner)
    node [midway, above left] {width};
  \draw [red, <->] (t.apex) -- (t.lower side)
    node [midway, above right] {height};
\end{tikzpicture}
```

There are PGF keys to customise this shape. To use these keys in TikZ, simply remove the `/pgf/` path.

`/pgf/isosceles triangle apex angle=<angle>` (no default, initially 45)

Sets the angle of the apex of the isosceles triangle.

`/pgf/isosceles triangle stretches=<boolean>` (default true)

By default *<boolean>* is false. This means, that when applying any minimum width or minimum height requirements, increasing the height will increase the width (and vice versa), in order to keep the apex angle the same.

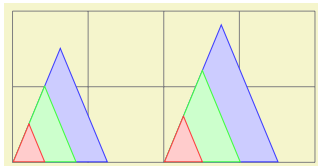

```
\begin{tikzpicture}[paint/.style={draw=#1!75, fill=#1!20}]
  \tikzset{every node/.style={isosceles triangle, draw, inner sep=0pt,
    anchor=left corner, shape border rotate=90}}
  \draw[help lines] grid(4,2);
  \foreach \a/\c in {1.5/blue, 1/green, 0.5/red}{
    \node[paint=\c, minimum height=\a cm] at (0,0) {};
    \node[paint=\c, minimum width=\a cm] at (2,0) {};
  }
\end{tikzpicture}
```

However, by setting *<boolean>* to true, minimum width and height can be applied independently.

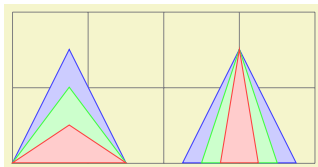

```
\begin{tikzpicture}[paint/.style={draw=#1!75, fill=#1!20}]
  \tikzset{every node/.style={isosceles triangle, draw, inner sep=0pt,
    anchor=south, shape border rotate=90, isosceles triangle stretches}}
  \draw[help lines] grid(4,2);
  \foreach \a/\c in {1.5/blue, 1/green, 0.5/red}{
    \node[paint=\c, minimum height=\a cm, minimum width=1.5cm] at (0.75,0) {};
    \node[paint=\c, minimum width=\a cm, minimum height=1.5cm] at (3,0) {};
  }
\end{tikzpicture}
```

The anchors for the `isosceles triangle` are shown below (anchor 150 is an example of a border anchor). Note that, somewhat confusingly, the anchor names such as `left side` and `right corner` are named as if the triangle is rotated to 90 degrees. Note also that the `center` anchor does not necessarily correspond to any kind of geometric center.

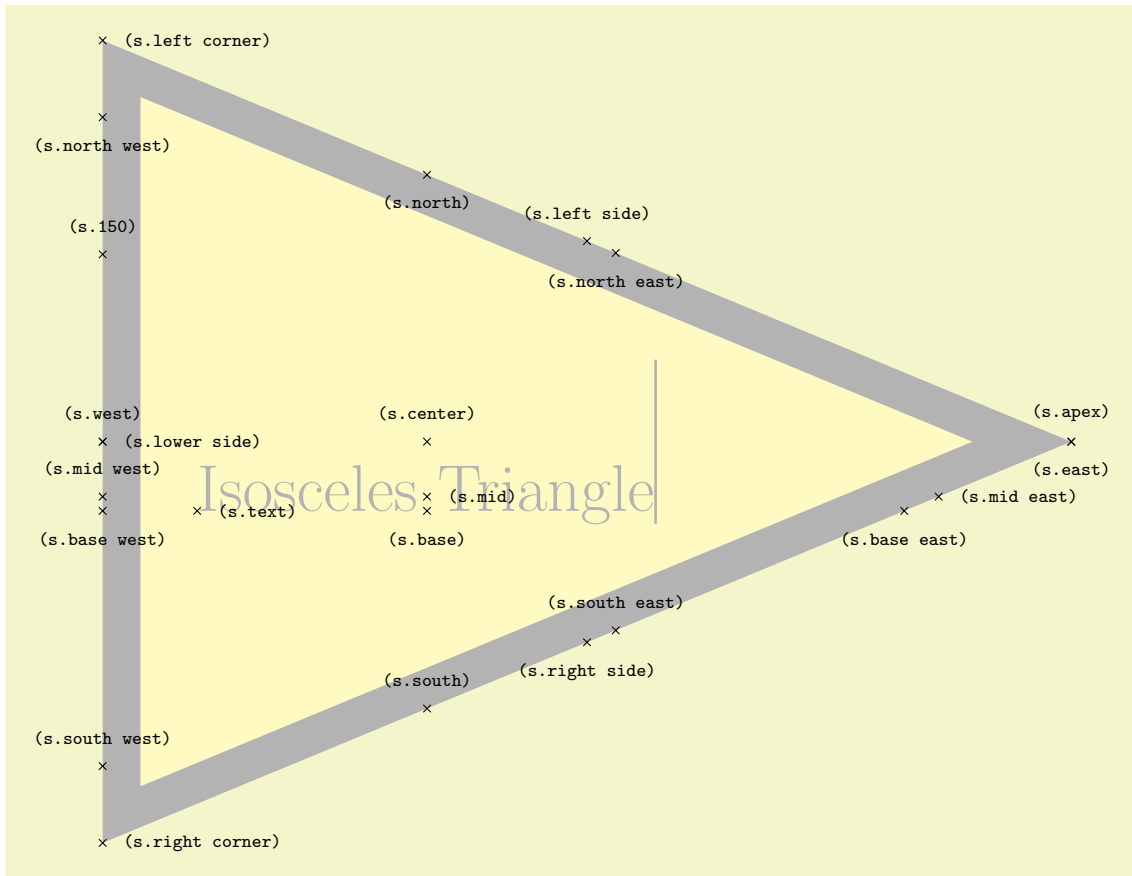

```

\Huge
\begin{tikzpicture}
\node[name=s, shape=isosceles triangle, shape example, inner xsep=1cm]
{Isosceles Triangle\vrule width 1pt height 2cm};
\foreach \anchor/\placement in
{apex/above, left corner/right, right corner/right,
left side/above, right side/below, lower side/right,
center/above, text/right, 150/above,
mid/right, mid west/above, mid east/right,
base/below, base west/below, base east/below,
west/above, east/below, north/below, south/above,
north west/below, north east/below,
south west/above, south east/above}
\draw[shift=(s.\anchor)] plot[mark=x] coordinates{(0,0)}
node[\placement] {\scriptsize\texttt{(s.\anchor)}};
\end{tikzpicture}

```

### Shape `kite`

This shape is a kite, which supports the rotation of the shape border, as described in Section 16.2.2. There are PGF keys to specify the upper and lower vertex angles of the kite. To use these keys in TikZ, simply remove the `/pgf/` path.

`/pgf/kite upper vertex angle= $\langle angle \rangle$`  (no default, initially 120)

Set the upper internal angle of the kite.

`/pgf/kite lower vertex angle= $\langle angle \rangle$`  (no default, initially 60)

Set the lower internal angle of the kite.

`/pgf/kite vertex angles= $\langle angle specification \rangle$`  (no default)

This key sets the keys for both the upper and lower vertex angles (it stores no value itself).  $\langle angle specification \rangle$  can be pair of angles in the form  $\langle upper angle \rangle$  and  $\langle lower angle \rangle$ , or a single angle. In this latter case, both the upper and lower vertex angles will be the same.



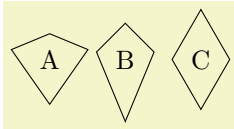

```
\begin{tikzpicture}
\tikzstyle{every node}=[kite, draw]
\node[kite upper vertex angle=135, kite lower vertex angle=70] at (0,0) {A};
\node[kite vertex angles=90 and 45] at (1,0) {B};
\node[kite vertex angles=60] at (2,0) {C};
\end{tikzpicture}
```

The anchors for the kite are shown below. Anchor 110 is an example of a border anchor.

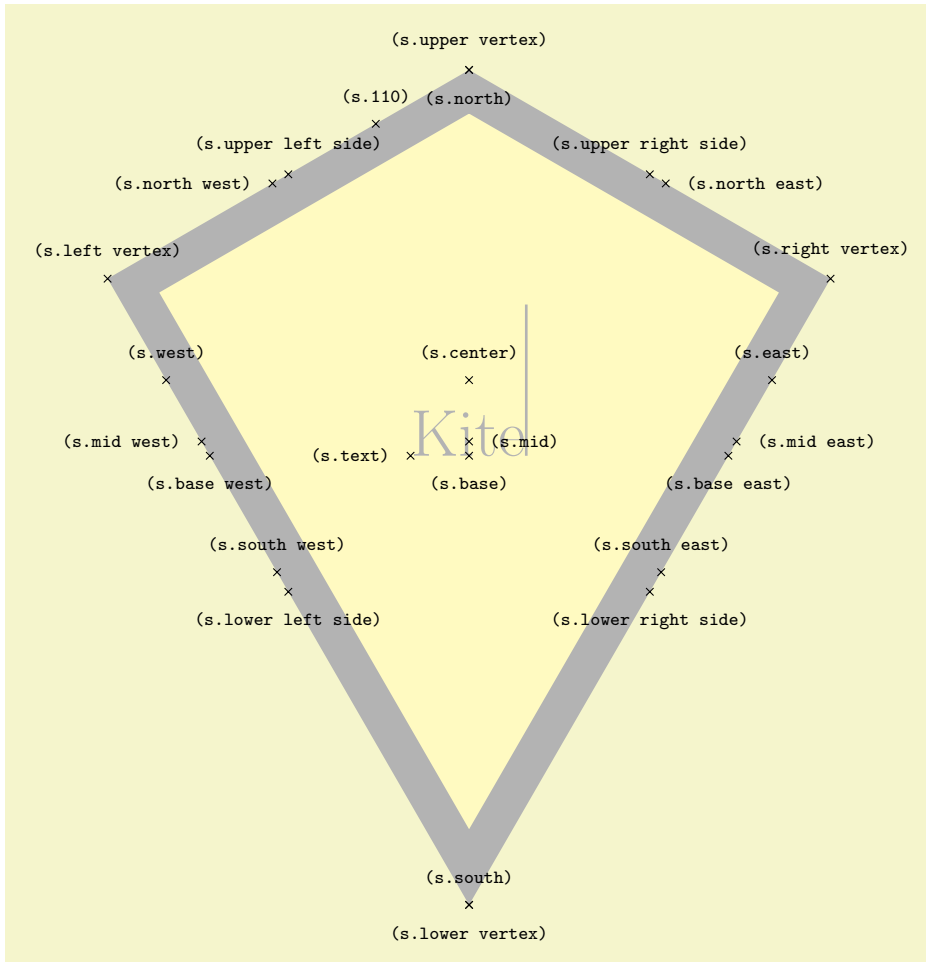

```
\Huge
\begin{tikzpicture}
\node[name=s, shape=kite, shape example, inner sep=1.5cm]
{Kite\vrule width 1pt height 2cm};
\foreach \anchor/\placement in
{upper vertex/above, left vertex/above, lower vertex/below,
right vertex/above, upper left side/above, upper right side/above,
lower left side/below, lower right side/below,
center/above, text/left, mid/right, base/below,
mid west/left, base west/below, mid east/right, base east/below,
west/above, east/above, north/below, south/above,
north west/left, north east/right,
south west/above, south east/above, 110/above}
\draw[shift=(s.\anchor)] plot[mark=x] coordinates{(0,0)}
node[\placement] {\scriptsize\texttt{(s.\anchor)}};
\end{tikzpicture}
```

### Shape **dart**

This shape is a dart (which can also be known as an arrowhead or concave kite). This shape supports the rotation of the shape border, as described in Section 16.2.2. The angle of the border rotation determines the direction in which the dart points (unless other transformations have been applied).

There are PGF keys to set the angle for the ‘tip’ of the dart and the angle between the ‘tails’ of the dart. To use these keys in TikZ, simply remove the `/pgf/` path.

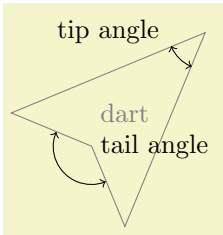

```
\begin{tikzpicture}
  \node[draw, gray, shape border uses incircle, shape border rotate=45]
    (d) {dart};
  \draw [<->] (d.tip)++(202.5:.5cm) arc(202.5:247.5:.5cm);
  \node [left=.5cm] at (d.tip) {tip angle};
  \draw [<->] (d.tail center)++(157.5:.5cm) arc(157.5:292.5:.5cm);
  \node [right] at (d.tail center) {tail angle};
\end{tikzpicture}
```

`/pgf/dart tip angle= $\langle angle \rangle$`  (no default, initially 45)

Set the angle at the tip of the dart.

`/pgf/dart tail angle= $\langle angle \rangle$`  (no default, initially 135)

Set the angle between the tails of the dart.

The anchors for the `dart` shape are shown below (note that the shape is rotated 90 degrees anti-clockwise). Anchor 110 is an example of a border anchor.

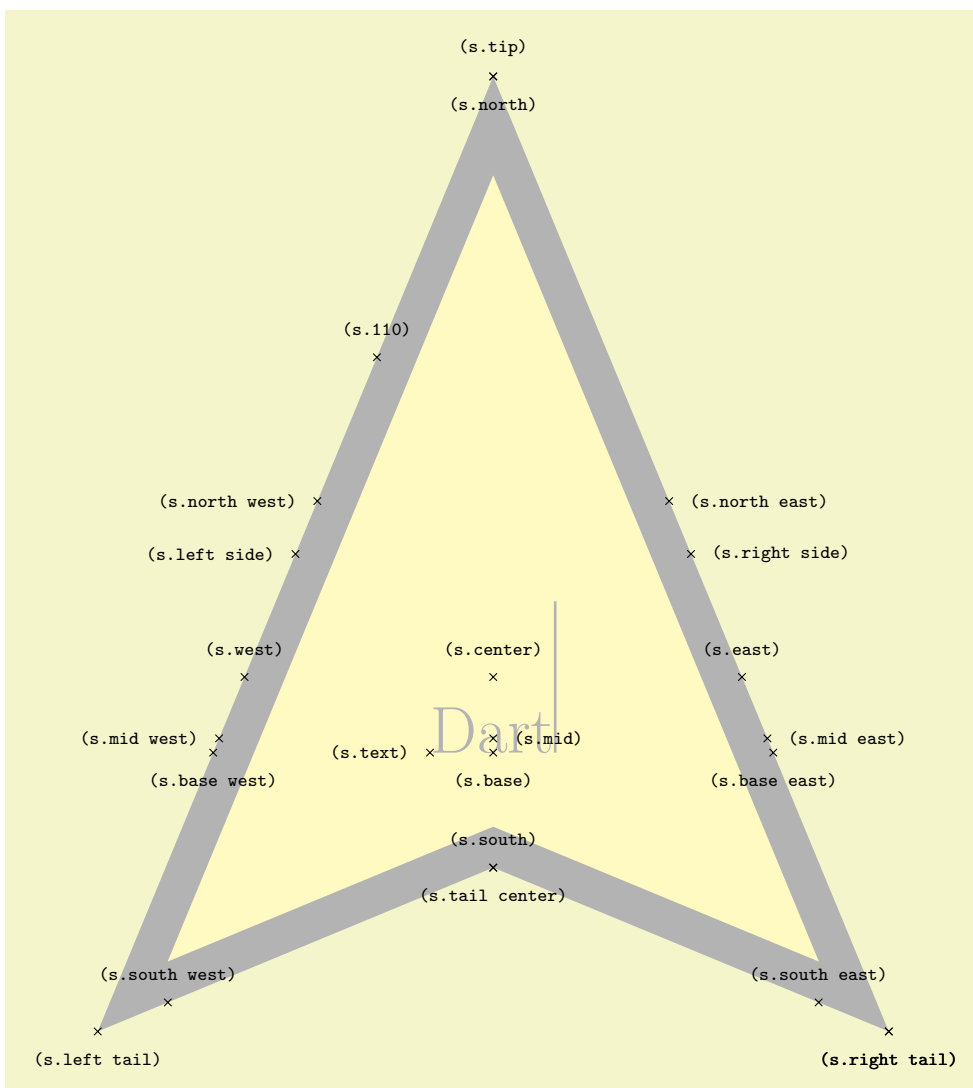

```

\Huge
\begin{tikzpicture}
  \node[name=s, shape=dart, shape border rotate=90, shape example, inner sep=1.25cm]
    {Dart\vrule width 1pt height 2cm};
  \foreach \anchor/\placement in
    {tip/above,      tail center/below, right tail/below,
     left tail/below, right tail/below, left side/left,   right side/right,
     center/above,  text/left,      mid/right,      base/below,
     mid west/left, base west/below, mid east/right,  base east/below,
     west/above,    east/above,    north/below,   south/above,
     north west/left, north east/right, south west/above, south east/above,
     110/above}
    \draw[shift=(s.\anchor)] plot[mark=x] coordinates{(0,0)}
      node[\placement] {\scriptsize\texttt{(s.\anchor)}};
\end{tikzpicture}

```

### Shape `circular sector`

This shape is a circular sector (which can also be known as a wedge). This shape supports the rotation of the shape border, as described in Section 16.2.2. The angle of the border rotation determines the direction in which the ‘apex’ of the sector points (unless other transformations have been applied).

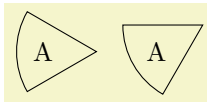

```

\begin{tikzpicture}
\tikzstyle{every node}=[circular sector, shape border uses incircle, draw];
  \node at (0,0) {A};
  \node [shape border rotate=30] at (1.5,0) {A};
\end{tikzpicture}

```

There is a PGF key to set the central angle of the sector, which is expected to be less than 180 degrees. To use this key in *TikZ*, simply remove the `/pgf/` path.

`/pgf/circular sector angle=angle` (no default, initially 60)

Set the central angle of the sector.

The anchors for the circular sector shape are shown below. Anchor 30 is an example of a border anchor.

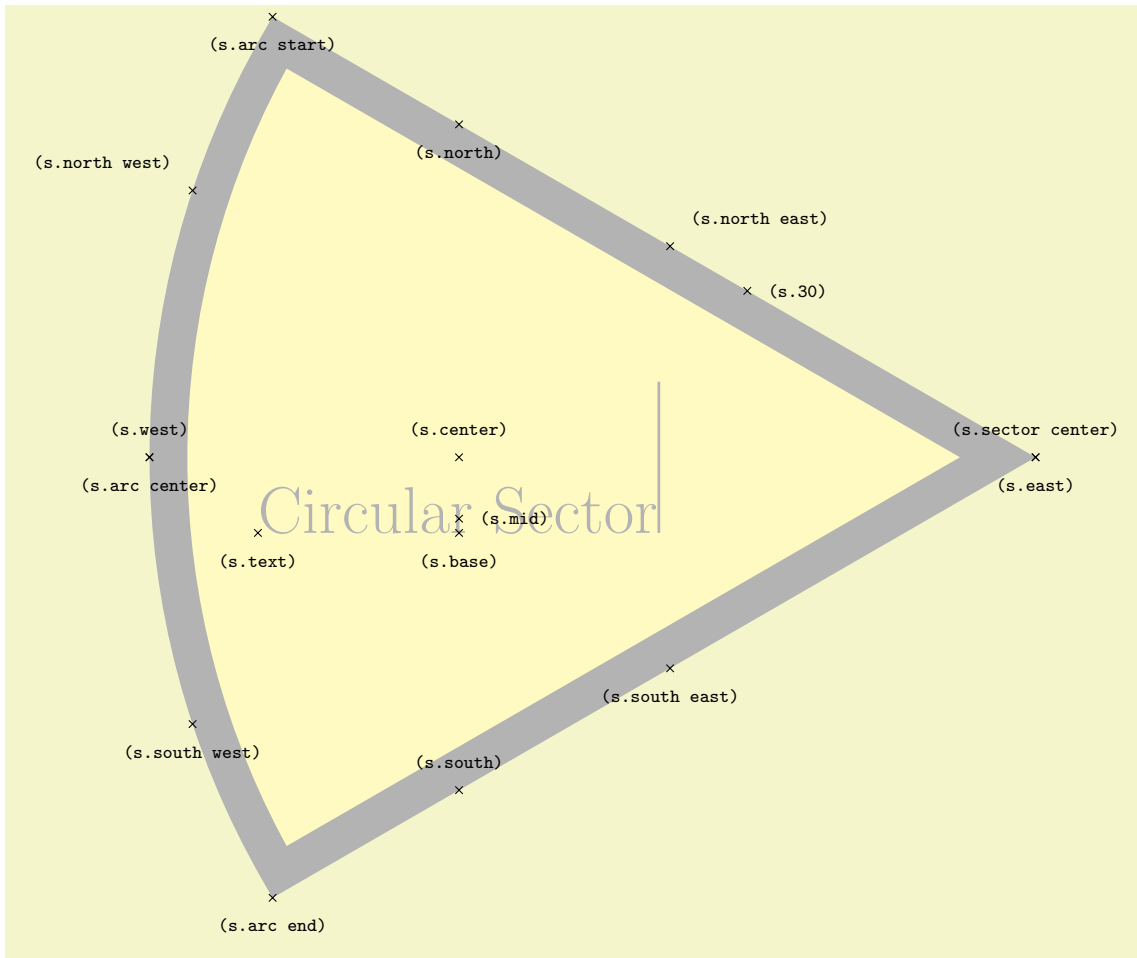

```

\Huge
\begin{tikzpicture}
  \node[name=s,shape=circular sector, style=shape example, inner sep=1cm]
  {Circular Sector\hrule width 1pt height 2cm};
  \foreach \anchor/\placement in
  {sector center/above, arc start/below, arc end/below, arc center/below,
  center/above, base/below, mid/right, text/below,
  north/below, south/above, east/below, west/above,
  north west/above left, north east/above right,
  south west/below, south east/below, 30/right}
  \draw[shift=(s.\anchor)] plot[mark=x] coordinates{(0,0)}
  node[\placement] {\scriptsize\texttt{(s.\anchor)}};
\end{tikzpicture}

```

### Shape `cylinder`

This shape is a 2-dimensional representation of a cylinder, which supports the rotation of the shape border as described in Section 16.2.2.



```

\begin{tikzpicture}
  \node[cylinder, draw, shape aspect=.5] {ABC};
\end{tikzpicture}

```

Regardless the rotation of the shape border, the height is always the distance between the curved ends, and the width is always the distance between the straight sides.

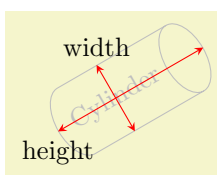

```

\begin{tikzpicture}[>=stealth]
  \node [cylinder, gray!50, rotate=30, draw,
  minimum height=2cm, minimum width=1cm] (c) {Cylinder};
  \draw[red, <->] (c.top) -- (c.bottom)
  node [at end, below, black] {height};
  \draw[red, <->] (c.north) -- (c.south)
  node [at start, above, black] {width};
\end{tikzpicture}

```

Enlarging the shape to some minimum height will stretch only the body of the cylinder. By contrast, enlarging the shape to some minimum width will stretch the curved ends.

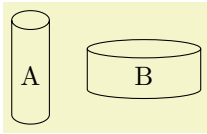

```
\begin{tikzpicture}[>=stealth, shape aspect=.5]
\tikzset{every node/.style={cylinder, shape border rotate=90, draw}}
\node [minimum height=1.5cm] {A};
\node [minimum width=1.5cm] at (1.5,0) {B};
\end{tikzpicture}
```

There are various keys to customize this shape (to use PGF keys in TikZ, simply remove the `/pgf/` path).

`/pgf/aspect=<value>` (no default, initially 1.0)

The aspect is a recommendation for the quotient of the radii of the cylinder end. This may be ignored if the shape is enlarged to some minimum width.



```
\begin{tikzpicture}[>=stealth]
\tikzset{every node/.style={cylinder, shape border rotate=90, draw}}
\node [aspect=1.0] {A};
\node [aspect=0.5] at (1,0) {B};
\node [aspect=0.25] at (2,0) {C};
\end{tikzpicture}
```

`/pgf/cylinder uses custom fill=<boolean>` (default true)

This enables the use of a custom fill for the body and the end of the cylinder. The background path for the shape should not be filled (e.g., in TikZ, the `fill` option for the node must be implicitly or explicitly set to `none`). Internally, this key sets the  $\TeX$ -if `\ifpgfcylinderusescustomfill` appropriately.

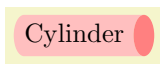

```
\begin{tikzpicture}[>=stealth, aspect=0.5]
\node [cylinder, cylinder uses custom fill, cylinder end fill=red!50,
cylinder body fill=red!25] {Cylinder};
\end{tikzpicture}
```

`/pgf/cylinder end fill=<color>` (no default, initially white)

Set the color for the end of the cylinder.

`/pgf/cylinder body fill=<color>` (no default, initially white)

Set the color for the body of the cylinder.

The anchors this shape are shown below (anchor 160 is an example of a border anchor). Note the the cylinder shape does not distinguish between `outer xsep` and `outer ysep`. Only the larger of the two values is used for the shape. Note also the difference between the `center` and `shape center` anchors: `center` is the center of the cylinder body and also the center of rotation. The `shape center` is the center of the shape which includes the 2-dimensional representation of the cylinder top.

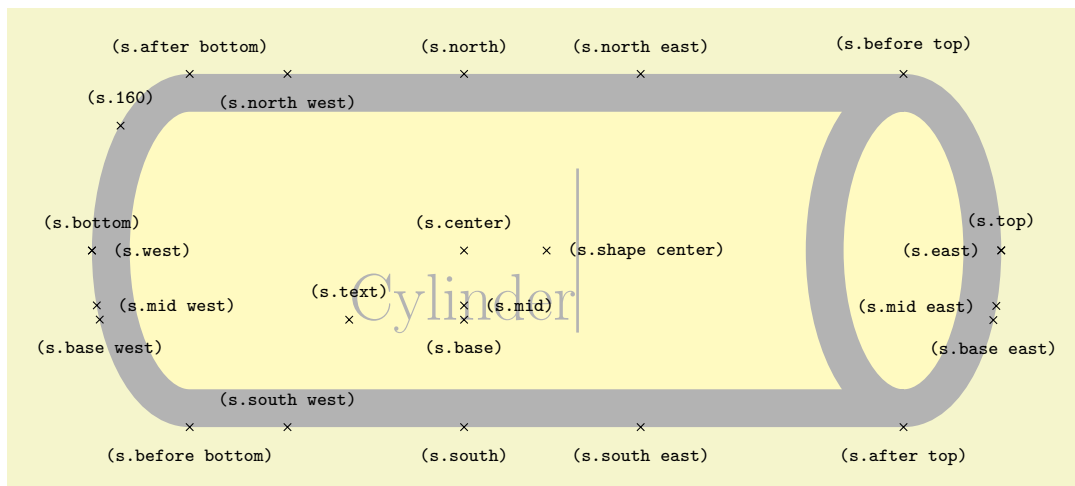

```

\Huge
\begin{tikzpicture}
  \node[name=s, shape=cylinder, shape example, aspect=.5, inner xsep=3cm,
        inner ysep=1cm] {Cylinder\vrule width 1pt height 2cm};
  \foreach \anchor/\placement in
    {before top/above,    top/above,        after top/below,
     before bottom/below, bottom/above,   after bottom/above,
     mid/right,           mid west/right, mid east/left,
     base/below,          base west/below, base east/below,
     center/above,        text/above,     shape center/right,
     west/right, east/left, north/above, south/below,
     north west/below, north east/above,
     south west/above, south east/below, 160/above}
  \draw[shift=(s.\anchor)] plot[mark=x] coordinates{(0,0)}
    node[\placement] {\scriptsize\texttt{(s.\anchor)}};
\end{tikzpicture}

```

## 46.4 Symbol Shapes

```

\usepgflibrary{shapes.symbols} %  $\TeX$  and plain  $\TeX$  and pure pgf
\usepgflibrary[shapes.symbols] % Con $\TeX$ t and pure pgf
\usetikzlibrary{shapes.symbols} %  $\TeX$  and plain  $\TeX$  when using TikZ
\usetikzlibrary[shapes.symbols] % Con $\TeX$ t when using TikZ

```

This library defines shapes that can be used for drawing symbols like a forbidden sign or a cloud.

### Shape `forbidden sign`

This shape places the node inside a circle with a diagonal from the lower left to the upper right added. The circle is part of the background, the diagonal line part of the foreground path; thus, the diagonal line is on top of the text.



```

\begin{tikzpicture}
  \node [forbidden sign,line width=1ex,draw=red,fill=white] {Smoking};
\end{tikzpicture}

```

The shape inherits all anchors from the `circle` shape, see also the following figure:

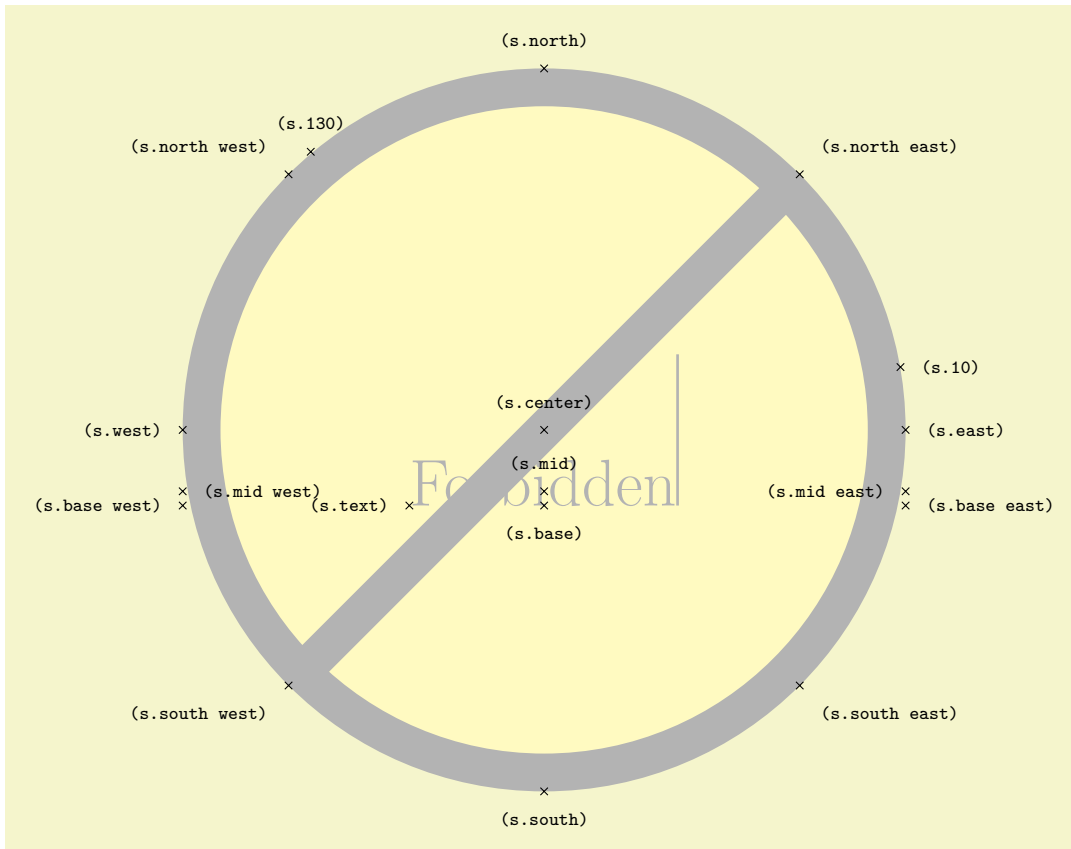

```

\Huge
\begin{tikzpicture}
  \node[name=s,shape=forbidden,shape example] {Forbidden\vrule width 1pt height 2cm};
  \foreach \anchor/\placement in
    {north west/above left, north/above, north east/above right,
     west/left, center/above, east/right,
     mid west/right, mid/above, mid east/left,
     base west/left, base/below, base east/right,
     south west/below left, south/below, south east/below right,
     text/left, 10/right, 130/above}
    \draw[shift=(s.\anchor)] plot[mark=x] coordinates{(0,0)}
      node[\placement] {\scriptsize\texttt{(s.\anchor)}};
\end{tikzpicture}

```

### Shape `cloud`

This shape is a cloud, drawn to tightly fit the node contents (strictly speaking, using an ellipse which tightly fits the node contents – including any `inner sep`).

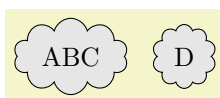

```

\begin{tikzpicture}
  \node[cloud, draw, fill=gray!20, aspect=2] {ABC};
  \node[cloud, draw, fill=gray!20] at (1.5,0) {D};
\end{tikzpicture}

```

A cloud should be thought of as having a number of “puffs”, which are the individual arcs drawn around the border. There are PGF keys to specify how the cloud is drawn (to use these keys in TikZ, simply remove the `/pgf/` path).

`/pgf/cloud puffs=<integer>` (no default, initially 10)

Set the number of puffs for the cloud.

`/pgf/cloud puff arc=<angle>` (no default, initially 135)

Set the length of the puff arc (in degrees). A shorter arc can produce better looking joins between puffs for larger line widths.

Like the diamond shape, the cloud shape also uses the `aspect` key, to determine the ratio of the width and the height of the cloud. However there may be circumstances where it may be undesirable to continually specify the `aspect` for the cloud. Therefore, the following key is implemented:

`/pgf/cloud ignores aspect=<boolean>` (default true)

Instruct PGF to ignore the `aspect` key. Internally, the TeX-if `\ifpgfcloudignoresaspect` is set appropriately. The initial value is `false`.

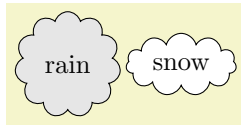

```
\begin{tikzpicture}[aspect=1, every node/.style={cloud, cloud puffs=11, draw}]
  \node [fill=gray!20] {rain};
  \node [cloud ignores aspect, fill=white] at (1.5,0) {snow};
\end{tikzpicture}
```

Any minimum size requirements are applied to the “circum-ellipse”, which is the ellipse which passes through all the midpoints of the puff arcs. These requirements are considered *after* any aspect specification is applied.

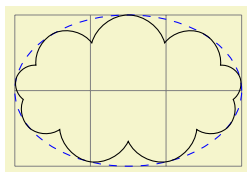

```
\begin{tikzpicture}
  \draw [help lines] grid (3,2);
  \draw [blue, dashed] (1.5, 1) ellipse (1.5cm and 1cm);
  \node [cloud, cloud puffs=9, draw, minimum width=3cm, minimum height=2cm]
    at (1.5, 1) {};
\end{tikzpicture}
```

The anchors for the cloud shape are shown below for a cloud with eleven puffs. Anchor 70 is an example of a border anchor.

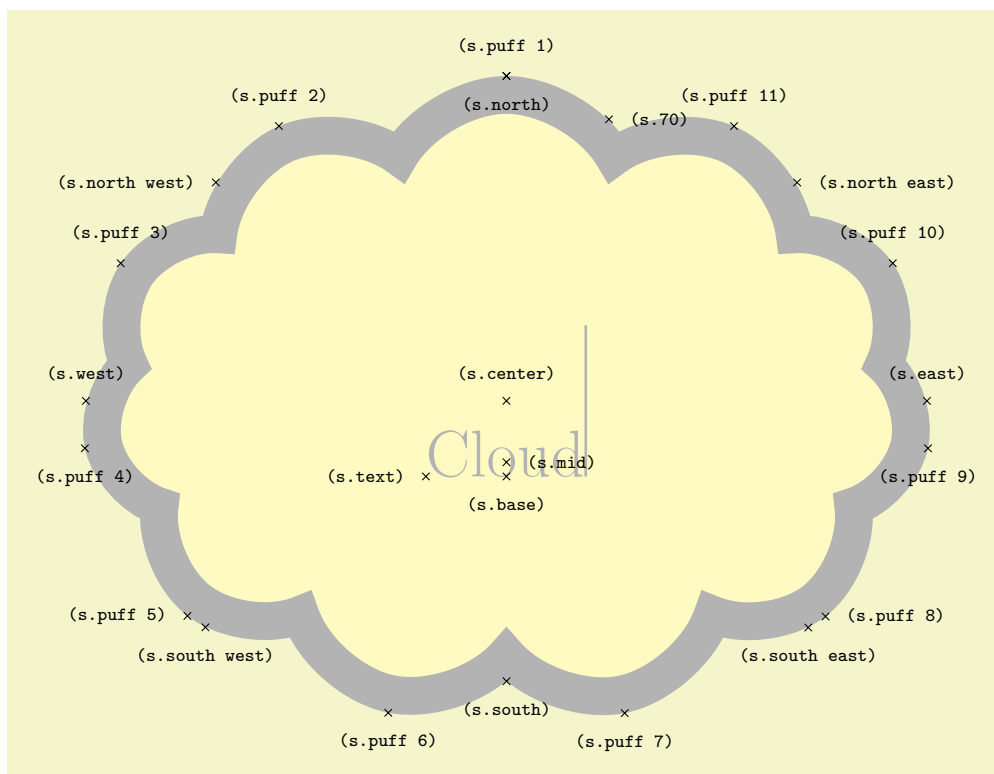



```

\Huge
\begin{tikzpicture}
  \node[name=s, shape=cloud, style=shape example, cloud puffs=11, aspect=1.5,
        cloud puff arc=120,inner ysep=1cm] {Cloud\vrule width 1pt height 2cm};
  \foreach \anchor/\placement in
  {puff 1/above, puff 2/above,   puff 3/above,   puff 4/below,
   puff 5/left,  puff 6/below,   puff 7/below,   puff 8/right,
   puff 9/below, puff 10/above,  puff 11/above, 70/right,
   center/above, base/below,    mid/right,     text/left,
   north/below, south/below,    east/above,    west/above,
   north west/left,              north east/right,
   south west/below,             south east/below}
  \draw[shift=(s.\anchor)] plot[mark=x] coordinates{(0,0)}
  node[\placement] {\scriptsize\texttt{(s.\anchor)}};
\end{tikzpicture}

```

### Shape `starburst`

This shape is a randomly generated elliptical star, which supports the rotating of the shape border as described in Section 16.2.2.



```

\begin{tikzpicture}
  \node[starburst, fill=yellow, draw=red, line width=2pt] {\bf BANG!};
\end{tikzpicture}

```

Like the `star` shape, the `starburst` should be thought of as having a set of inner points and outer points. The inner points lie on the ellipse which tightly fits the node contents (including any `inner sep`).

Using a specified ‘starburst point height’ value, the outer points are generated randomly between this value and one quarter of this value. For a given starburst shape the angle between each point is fixed, and is determined by the number of points specified for the starburst.

It is important to note that, whilst the maximum possible point height is used to calculate minimum width or height requirements, the outer points are randomly generated, so there is (unfortunately) no guarantee that any such requirements will be fully met.

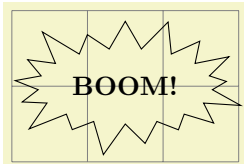

```

\begin{tikzpicture}
  \draw[help lines] grid(3,2);
  \node[starburst, draw, minimum width=3cm, minimum height=2cm]
  at (1.5, 1) {\bf BOOM!};
\end{tikzpicture}

```

There are PGF keys to control the drawing of the starburst shape. To use these keys in *TikZ*, simply remove the `/pgf/` path.

`/pgf/starburst points=<integer>` (no default, initially 17)

Set the number of points for the starburst.

`/pgf/starburst point height=<length>` (no default, initially .5cm)

Set the *maximum* distance between the inner point radius and the outer point radius.

`/pgf/random starburst=<integer>` (no default, initially 100)

Set the seed for the random number generator for creating the starburst. The maximum value for *<integer>* is 16383. If *<integer>*=0, the random number generator will not be used, and the maximum point height will be used for all outer points. If *<integer>* is omitted, a seed will be randomly chosen.

The basic anchors for a nine point `starburst` shape are shown below. Anchor 80 is an example of a border anchor.

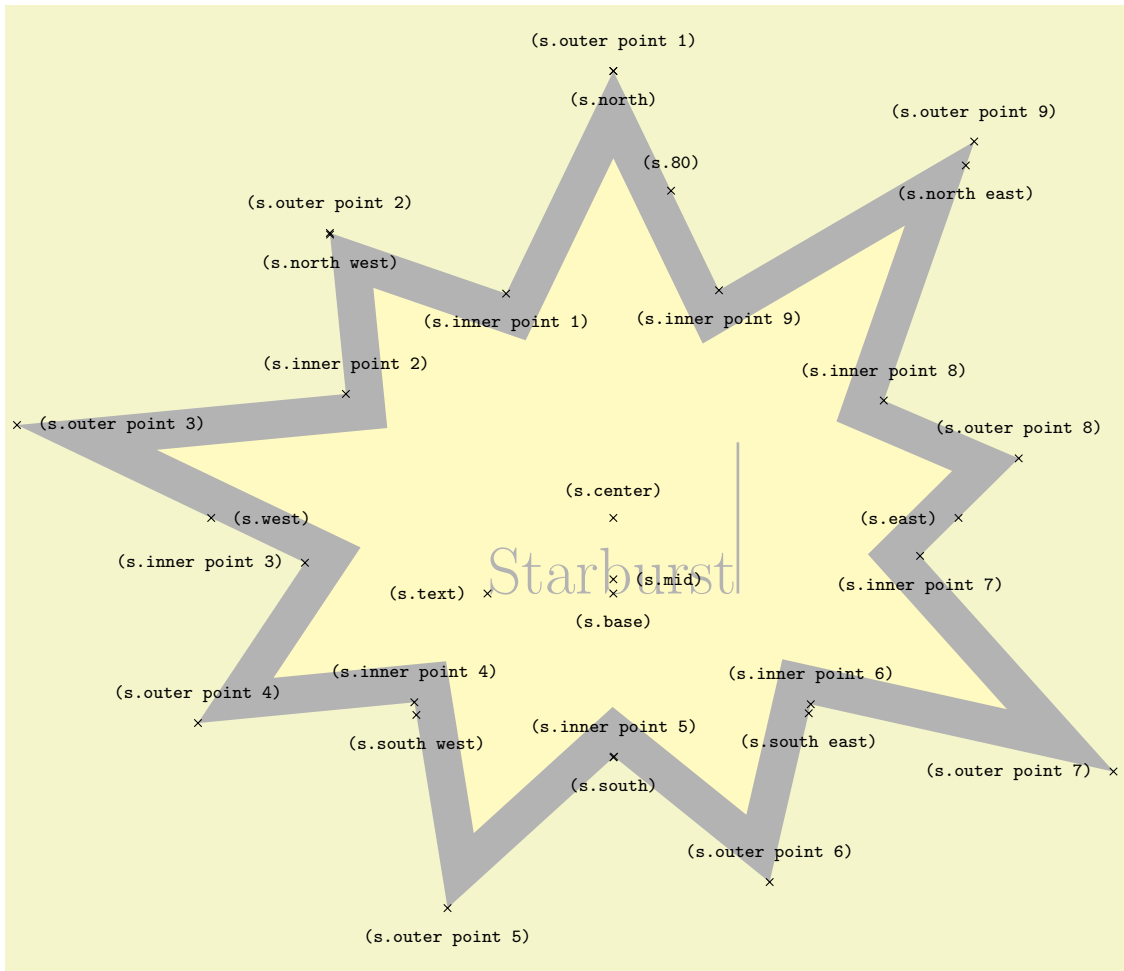

```

\Huge
\begin{tikzpicture}
  \node[name=s, shape=starburst, starburst points=9, starburst point height=3.5cm,
        style=shape example, inner sep=1cm]
    {Starburst\vrule width 1pt height 2cm};
  \foreach \anchor/\placement in
    {outer point 1/above, outer point 2/above, outer point 3/right,
     outer point 4/above, outer point 5/below, outer point 6/above,
     outer point 7/left, outer point 8/above, outer point 9/above,
     inner point 1/below, inner point 2/above, inner point 3/left,
     inner point 4/above, inner point 5/above, inner point 6/above,
     inner point 7/below, inner point 8/above, inner point 9/below,
     center/above, text/left, mid/right, base/below, 80/above,
     north/below, south/below, east/left, west/right,
     north east/below, south west/below, south east/below, north west/below}
    \draw[shift=(s.\anchor)] plot[mark=x] coordinates{(0,0)}
      node[\placement] {\scriptsize\texttt{(s.\anchor)}};
\end{tikzpicture}

```

### Shape **signal**

This shape is a “signal” or sign shape, that is, a rectangle, with optionally pointed sides. A signal can point “to” somewhere, with outward points in that direction. It can also be “from” somewhere, with inward points from that direction. The resulting points extend the node contents (which include the `inner sep`).

To East

From East

```

\begin{tikzpicture}
  [every node/.style={signal, draw, text=white, signal to=nowhere}]
  \node[fill=green!65!black, signal to=east] at (0,1) {To East};
  \node[fill=red!65!black, signal from=east] at (0,0) {From East};
\end{tikzpicture}

```

There are PGF keys for drawing the signal shape (to use these keys in TikZ, simply remove the `/pgf/`

path):

`/pgf/signal pointer angle=<angle>` (no default, initially 90)

Set the angle for the pointed sides of the shape. This angle is maintained when enforcing any minimum size requirements, so any adjustment to the width will affect the height, and vice versa.

`/pgf/signal from=<direction> and <opposite direction>` (no default, initially `nowhere`)

Set which sides take an inward pointer (i.e., that points towards the center of the shape). The possible values for `<direction>` and `<opposite direction>` are the compass point directions `north`, `south`, `east` and `west` (or `above`, `below`, `right` and `left`). An additional keyword `nowhere` can be used to reset the sides so they have no pointers. When used with `signal from` key, this only resets inward pointers; used with the `signal to` key, it only resets outward pointers.

`/pgf/signal to=<direction> and <opposite direction>` (no default, initially `east`)

Set which sides take an outward pointer (i.e., that points away from the the shape).

Note that PGF will ignore any instruction to use directions that are not opposites (so using the value `east and north`, will result in only `north` being assigned a pointer). This is also the case if non-opposite values are used in the `signal to` and `signal from` keys at the same time. So, for example, it is not possible for a signal to have an outward point to the left, and also have an inward point from below.

The anchors for the signal shape are shown below. Anchor `70` is an example of a border anchor.

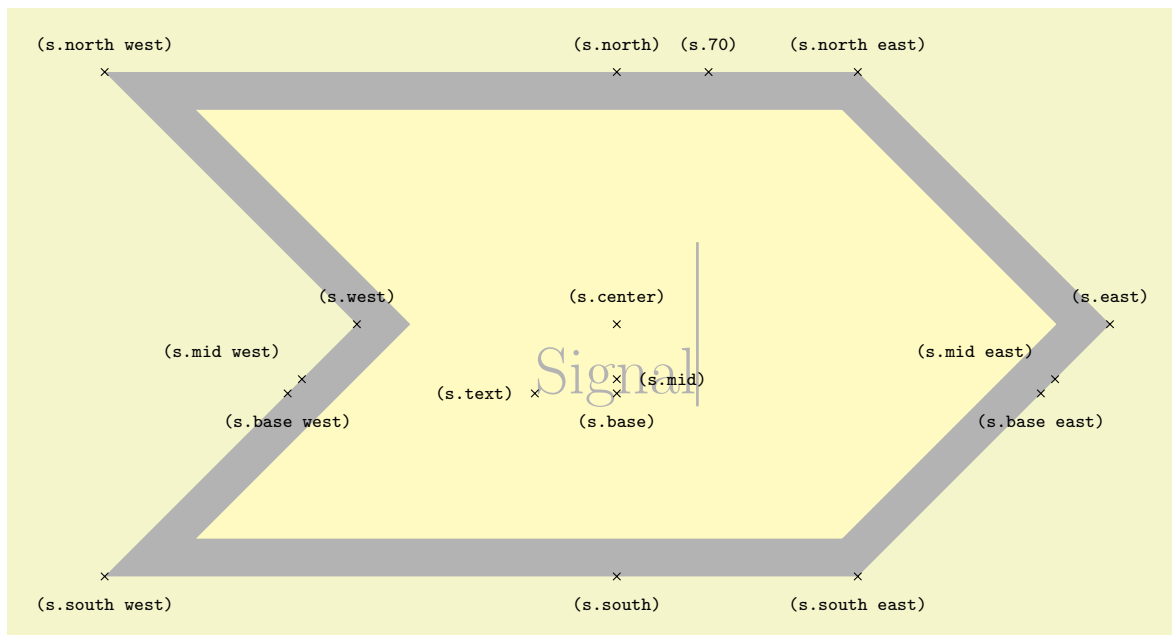

```
\Huge
\begin{tikzpicture}
\node[name=s, shape=signal, signal from=west, shape example, inner sep=2cm]
{Signal\vrule width1pt height2cm};
\foreach \anchor/\placement in
{text/left, center/above, 70/above,
base/below, base east/below, base west/below,
mid/right, mid east/above left, mid west/above left,
north/above, south/below,
east/above, west/above,
north west/above, north east/above,
south west/below, south east/below}
\draw[shift=(s.\anchor)] plot[mark=x] coordinates{(0,0)}
node[\placement] {\scriptsize\texttt{(s.\anchor)}};
\end{tikzpicture}
```

### Shape `tape`

This shape is a rectangle with optional, “bendy” top and bottom sides, which tightly fits the node contents (including the `inner sep`).



```
\begin{tikzpicture}
  \node[tape, draw]{ABCD};
  \node[tape, draw, tape bend top=none] at (1.5, 0) {EFGH};
\end{tikzpicture}
```

There are PGF keys to specify which sides bend and how high the bends are (to use these keys in TikZ, simply remove the `/pgf/` path):

`/pgf/tape bend top=<bend style>` (no default, initially `in and out`)

Specify how the top side bends. The `<bend style>` is either `in and out`, `out and in` or `none` (i.e., a straight line). The bending sides are drawn in a clockwise direction, and using the bend style `in and out` will mean the side will first bend inwards and then bend outwards. The opposite holds true for `out and in`.

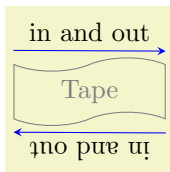

```
\begin{tikzpicture}[-stealth]
  \node[tape, draw, gray, minimum width=2cm] (t){Tape};
  \draw [blue]([yshift=5pt] t.north west) -- ([yshift=5pt]t.north east)
    node[midway, above, black]{in and out};
  \draw [blue]([yshift=-5pt]t.south east) -- ([yshift=-5pt]t.south west)
    node[sloped, allow upside down, midway, above, black]{in and out};
\end{tikzpicture}
```

This might take a bit of getting used to, but just remember that when you want the bendy sides to be parallel, the sides take the same bend style. It is possible for the top and bottom sides to take opposite bend styles, but the author of this shape cannot think of a single use for such a combination.

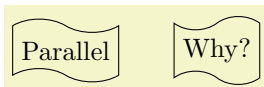

```
\begin{tikzpicture}
  \tikzstyle{every node}=[tape, draw]
  \node [tape bend top=out and in, tape bend bottom=out and in] {Parallel};
  \node at (2,0) [tape bend bottom=out and in] {Why?};
\end{tikzpicture}
```

`/pgf/tape bend bottom=<bend style>` (no default, initially `in and out`)

Specify how the bottom side bends.

`/pgf/tape bend height=<length>` (no default, initially `5pt`)

Set the total height for a side with a bend.

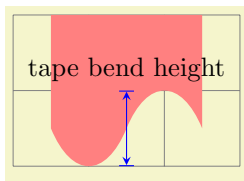

```
\begin{tikzpicture}[>stealth]
  \draw [help lines] grid(3,2);
  \node [tape, fill, minimum size=2cm, red!50, tape bend top=none,
    tape bend height=1cm] at (1.5,1.5) (t) {};
  \draw [|->|, blue] (1.5,0) -- (1.5,1)
    node [at end, above, black]{tape bend height};
\end{tikzpicture}
```

The anchors for the tape shape are shown below. Anchor `60` is an example of a border anchor. Note that border anchors will snap to the center of convex curves (i.e. when bending in).



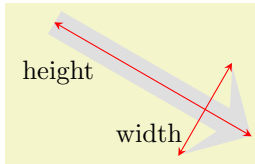

```
\begin{tikzpicture}[>=stealth,
  rotate border/.style={shape border uses incircle, shape border rotate=#1}]
\node[rotate border=-30, fill=gray!25, minimum height=3cm, single arrow,
  single arrow head extend=.5cm, single arrow head indent=.25cm] (arrow) {};
\draw[red, <->] (arrow.before tip) -- (arrow.after tip)
  node [near end, left, black] {width};
\draw[red, <->] (arrow.tip) -- (arrow.tail)
  node [near end, below left, black] {height};
\end{tikzpicture}
```

There are PGF keys that can be used to customize this shape (to use these keys in TikZ, simply remove the `/pgf/` path).

`/pgf/single arrow tip angle=<angle>` (no default, initially 90)

Set the angle for the arrow tip. Enlarging the arrow to some minimum width may increase the the height of the shape to maintain this angle.

`/pgf/single arrow head extend=<length>` (no default, initially .5cm)

This sets the distance between the tail of the arrow and the outer end of the arrow head. This may change if the shape is enlarged to some minimum width.

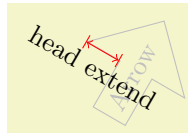

```
\begin{tikzpicture}
\node[single arrow, draw, single arrow head extend=.5cm, gray!50, rotate=60]
  (a) {Arrow};
\draw[red, |<->|] (a.before tip) -- (a.before head)
  node [midway, below, sloped, black] {head extend};
\end{tikzpicture}
```

`/pgf/single arrow head indent=<length>` (no default, initially 0cm)

This moves the point where the arrow head joins the shaft of the arrow *towards* the arrow tip, by `<length>`.

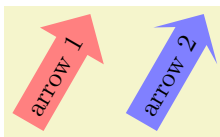

```
\begin{tikzpicture}[every node/.style={single arrow, draw=none, rotate=60}]
\node [fill=red!50] {arrow 1};
\node [fill=blue!50, single arrow head indent=1ex] at (1.5,0) {arrow 2};
\end{tikzpicture}
```

The anchors for this shape are shown below (anchor 20 is an example of a border anchor).

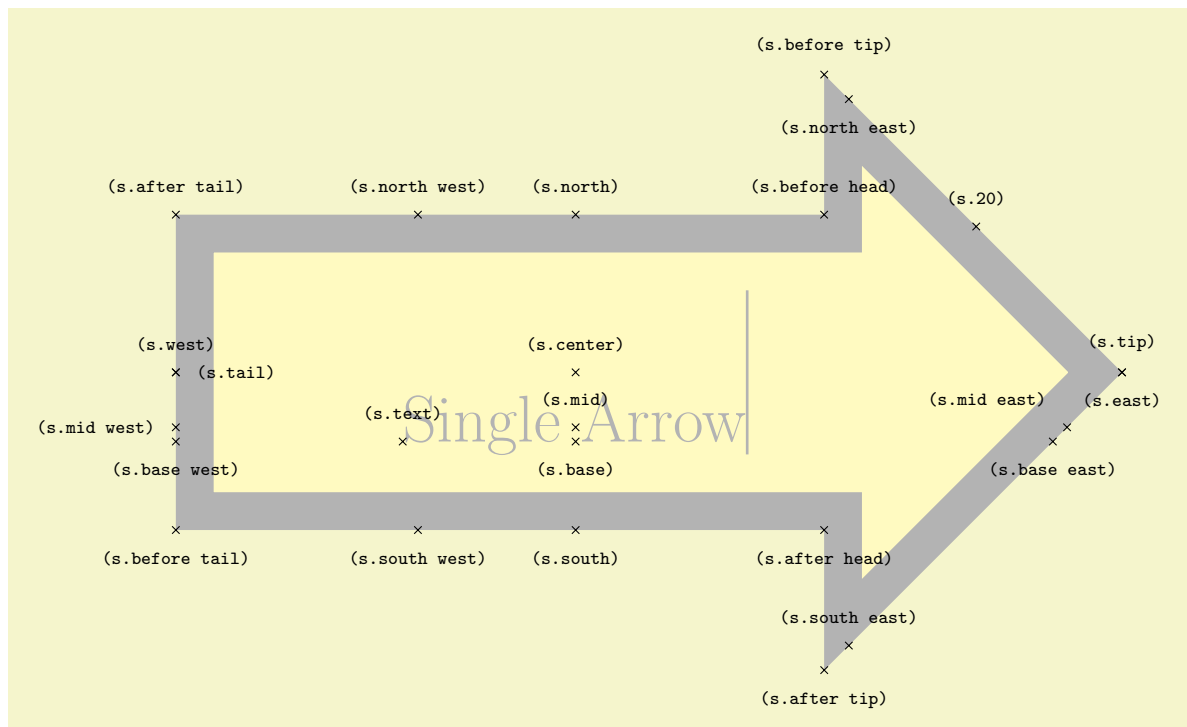

```

\Huge
\begin{tikzpicture}
  \node[name=s,shape=single arrow, shape example, single arrow head extend=1.5cm]
  {Single Arrow\vrule width1pt height2cm};
  \foreach \anchor/\placement in
  {text/above, center/above, 20/above,
  mid west/left, mid/above, mid east/above left,
  base west/below, base/below, base east/below,
  tip/above, before tip/above, after tip/below, before head/above,
  after head/below, after tail/above, before tail/below, tail/right,
  north/above, south/below, east/below, west/above,
  north west/above, north east/below, south west/below, south east/above}
  \draw[shift=(s.\anchor)] plot[mark=x] coordinates{(0,0)}
  node[\placement] {\scriptsize\texttt{(s.\anchor)}};
\end{tikzpicture}

```

### Shape `double arrow`

This shape is a double arrow, which tightly fits the note contents (including any `inner sep`), and supports the rotation of the shape border, as described in Section 16.2.2.

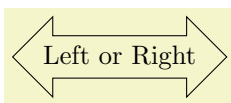

```

\begin{tikzpicture}[every node/.style={double arrow, draw}]
  \node [double arrow, draw] {Left or Right};
\end{tikzpicture}

```

The double arrow behaves exactly like the single arrow, so you need to remember that the width is *always* the distance between the back ends of the arrow heads, and the height is *always* the tip-to-tip distance.

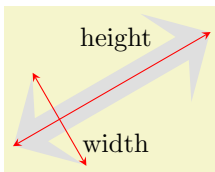

```

\begin{tikzpicture}[>=stealth,
  rotate border/.style={shape border uses incircle, shape border rotate=#1}]
  \node[rotate border=210, fill=gray!25, minimum height=3cm, double arrow,
  double arrow head extend=.5cm, double arrow head indent=.25cm] (arrow) {};
  \draw[red, <->] (arrow.before tip 1) -- (arrow.after tip 1)
  node [near start, right, black] {width};
  \draw[red, <->] (arrow.tip 1) -- (arrow.tip 2)
  node [near end, above left, black] {height};
\end{tikzpicture}

```

The PGF keys that can be used to customize the double arrow behave similarly to the keys for the single arrow (to use these keys in TikZ, simply remove the `/pgf/` path).

`/pgf/double arrow tip angle= $\langle angle \rangle$`  (no default, initially 90)

Set the angle for the arrow tip. Enlarging the arrow to some minimum width may increase the the height of the shape to maintain this angle.

`/pgf/double arrow head extend= $\langle length \rangle$`  (no default, initially .5cm)

This sets the distance between the shaft of the arrow and the outer end of the arrow heads. This may change if the shape is enlarged to some minimum width.

`/pgf/double arrow head indent= $\langle length \rangle$`  (no default, initially 0cm)

This moves the point where the arrow heads join the shaft of the arrow *towards* the arrow tips, by  $\langle length \rangle$ .

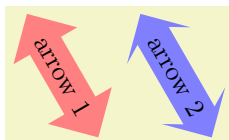

```

\begin{tikzpicture}[every node/.style={double arrow, draw=none, rotate=-60}]
  \node [fill=red!50] {arrow 1};
  \node [fill=blue!50, double arrow head indent=1ex] at (1.5,0) {arrow 2};
\end{tikzpicture}

```

The anchors for this shape are shown below (anchor 20 is an example of a border anchor).

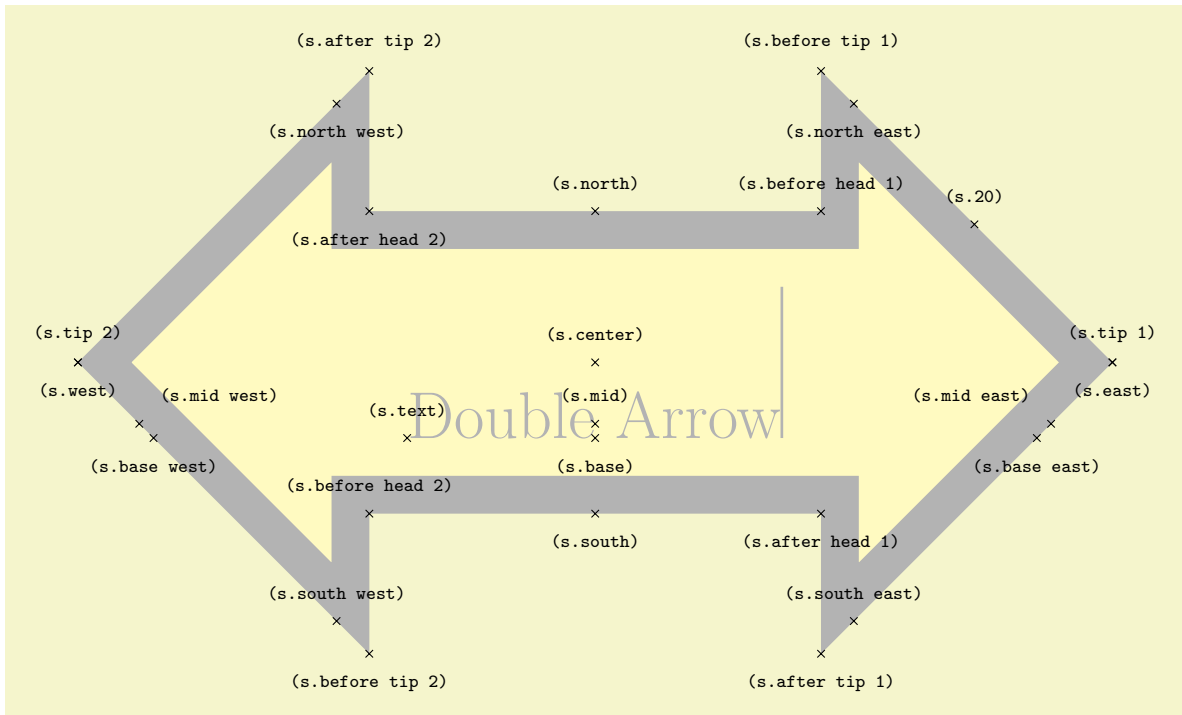

```

\Huge
\begin{tikzpicture}
\node[name=s,shape=double arrow, double arrow head extend=1.5cm, shape example, inner xsep=2cm]
{Double Arrow\vrule width1pt height2cm};
\foreach \anchor/\placement in
{text/above, center/above, 20/above,
mid west/above right, mid/above, mid east/above left,
base west/below, base/below, base east/below,
before head 1/above, before tip 1/above, tip 1/above, after tip 1/below, after head 1/below,
before head 2/above, before tip 2/below, tip 2/above, after tip 2/above, after head 2/below,
north/above, south/below, east/below, west/below,
north west/below, north east/below, south east/above, south west/above}
\draw[shift=(s.\anchor)] plot[mark=x] coordinates{(0,0)}
node[\placement] {\scriptsize\texttt{(s.\anchor)}};
\end{tikzpicture}

```

### Shape **arrow box**

This shape is a rectangle with optional arrows which extend from the four sides.

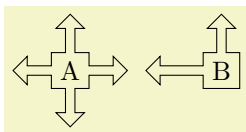

```

\begin{tikzpicture}
\node[arrow box, draw] {A};
\node[arrow box, draw, arrow box arrows={north:.5cm, west:0.75cm}]
at (2,0) {B};
\end{tikzpicture}

```

Any minimum size requirements are applied to the main rectangle *only*. This does not pose too many problems if you wish to accommodate the length of the arrows, as it is possible to specify the length of each arrow independently, from either the border of the rectangle (the default) or the center of the rectangle.

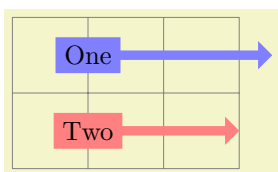

```

\begin{tikzpicture}
\tikzset{box/.style={arrow box, fill=#1}}
\draw [help lines] grid(3,2);
\node[box=blue!50, arrow box arrows={east:2cm}] at (1,1.5){One};
\node[box=red!50, arrow box arrows={east:2cm from center}] at (1,0.5){Two};
\end{tikzpicture}

```

There are various PGF keys for drawing this shape (to use these keys in TikZ, simply remove the `/pgf/` path).

`/pgf/arrow box tip angle= $\langle angle \rangle$`

(no default, initially 90)



Set the angle at the arrow tip for all four arrows.

`/pgf/arrow box head extend=<length>` (no default, initially .125cm)

Set the the distance the arrow head extends away from the the shaft of the arrow. This applies to all arrows.

`/pgf/arrow box head indent=<length>` (no default, initially 0cm)

Move the point where the arrow head joins the shaft of the arrow *towards* the arrow tip. This applies to all arrows.

`/pgf/arrow box shaft width=<length>` (no default, initially .125cm)

Set the width of the shaft of all arrows.

`/pgf/arrow box north arrow=<distance>` (no default, initially .5cm)

Set distance the north arrow extends from the node. By default this is from the border of the shape, but by using the additional keyword `from center`, the distance will be measured from the center of the shape. If `<distance>` is `0pt` or a negative distance, the arrow will not be drawn.

`/pgf/arrow box south arrow=<distance>` (no default, initially .5cm)

Set distance the south arrow extends from the node.

`/pgf/arrow box east arrow=<distance>` (no default, initially .5cm)

Set distance the east arrow extends from the node.

`/pgf/arrow box west arrow=<distance>` (no default, initially .5cm)

Set distance the west arrow extends from the node.

`/pgf/arrow box arrows={<list>}` (no default)

Set the distance that all arrows extend from the node. The specification in `<list>` consists of the four compass points `north`, `south`, `east` or `west`, separated by commas (so the list must be contained within braces). The distances can be specified after each side separated by a colon (e.g., `north:1cm`, or `west:5cm from center`). If an item specifies no distance, the most recently specified distance will be used (at the start of the list this is `0cm`, so the first item in the list should specify a distance). Any sides not specified will not be drawn with an arrow.

The anchors for this shape are shown below (unfortunately due to its size, this example must be rotated). Anchor 75 is an example of a border anchor. If a side is drawn without an arrow, the anchors for that arrow should be considered unavailable. They are (unavoidably) defined, but default to the center of the appropriate side.



```

\Huge
\begin{tikzpicture}
  \node[shape=arrow box, shape example, inner xsep=1cm, inner ysep=1.5cm, arrow box shaft width=2cm,
        arrow box arrows={north:3.5cm from border, south, east:5cm from border, west},
        arrow box head extend=0.75cm, rotate=-90](s) {Arrow Box\vrule width1pt height2cm};
  \foreach \anchor/\placement in
  {center/above, text/above, mid/right, base/below, 75/above,
   mid east/right, mid west/left, base east/right, base west/left,
   north/below, south/below, east/below, west/below,
   north east/above, south east/above, south west/below, north west/below,
   north arrow tip/above,south arrow tip/above, east arrow tip/above, west arrow tip/above,
   before north arrow/above, before north arrow head/below left, before north arrow tip/above left,
   after north arrow tip/above right, after north arrow head/below right, after north arrow/below,
   before south arrow/below, before south arrow head/above right, before south arrow tip/below right,
   after south arrow tip/below left, after south arrow head/above left, after south arrow/above,
   before east arrow/above, before east arrow head/above right, before east arrow tip/above,
   after east arrow tip/below, after east arrow head/below right, after east arrow/below,
   before west arrow/below, before west arrow head/below left, before west arrow tip/below,
   after west arrow tip/above, after west arrow head/above left, after west arrow/below}
    \draw[shift=(s.\anchor)] plot[mark=x] coordinates{(0,0)}
      node[\placement, rotate=-90] {\scriptsize\texttt{(s.\anchor)}};
\end{tikzpicture}

```

## 46.6 Shapes with Multiple Text Parts

```

\usepgflibrary{shapes.multipart} %  $\TeX$  and plain  $\TeX$  and pure pgf
\usepgflibrary[shapes.multipart] % Con $\TeX$ t and pure pgf
\usetikzlibrary{shapes.multipart} %  $\TeX$  and plain  $\TeX$  when using TikZ
\usetikzlibrary[shapes.multipart] % Con $\TeX$ t when using TikZ

```

This library defines general-purpose shapes that are composed of multiple (text) parts.

### Shape `circle split`

This shape is a multi-part shape consisting of a circle with a line in the middle. The upper part is the main part (the `text` part), the lower part is the `lower` part.

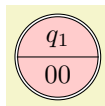

```

\begin{tikzpicture}
  \node [circle split,draw,double,fill=red!20]
  {
    $q_1$
    \nodepart{lower}
    $00$
  };
\end{tikzpicture}

```

The shape inherits all anchors from the `circle` shape and defines the `lower` anchor in addition. See also the following figure:

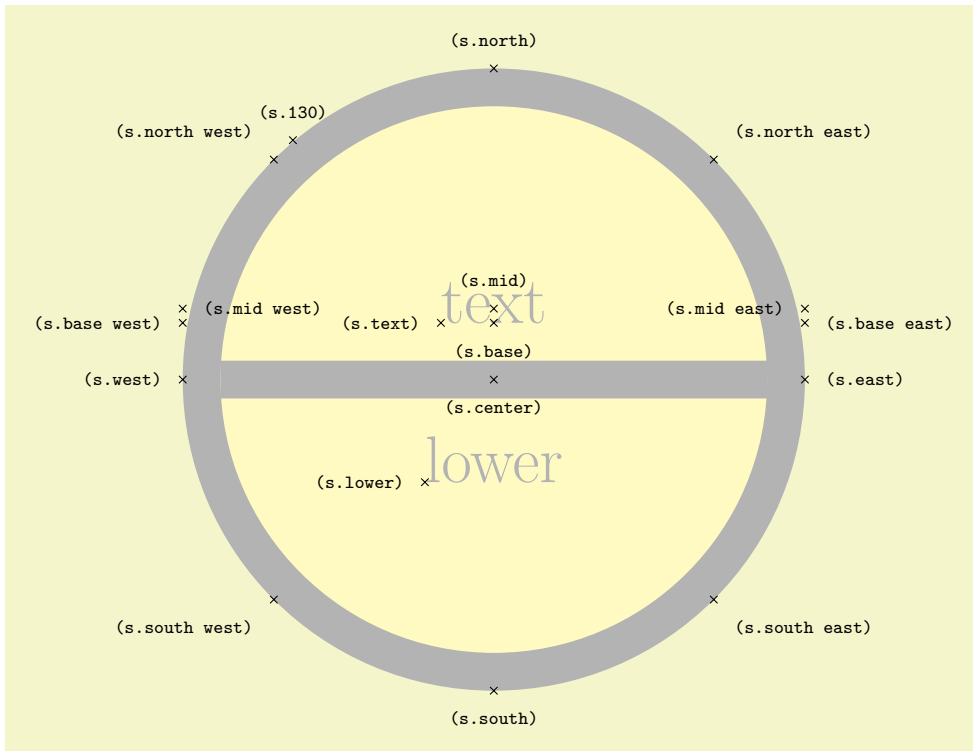

```

\Huge
\begin{tikzpicture}
\node[name=s,shape=circle split,shape example] {text\nodepart{lower}lower};
\foreach \anchor/\placement in
{north west/above left, north/above, north east/above right,
west/left, center/below, east/right,
mid west/right, mid/above, mid east/left,
base west/left, base/below, base east/right,
south west/below left, south/below, south east/below right,
text/left, lower/left, 130/above}
\draw[shift=(s.\anchor)] plot[mark=x] coordinates{(0,0)}
node[\placement] {\scriptsize\texttt{(s.\anchor)}};
\end{tikzpicture}

```

### Shape `circle solidus`

This shape (due to Manuel Lacruz) is similar to the split circle, but the two text parts are arranged diagonally.

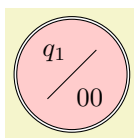

```

\begin{tikzpicture}
\node [circle solidus,draw,double,fill=red!20]
{
$q_1$
\nodepart{lower}
$00$
};
\end{tikzpicture}

```

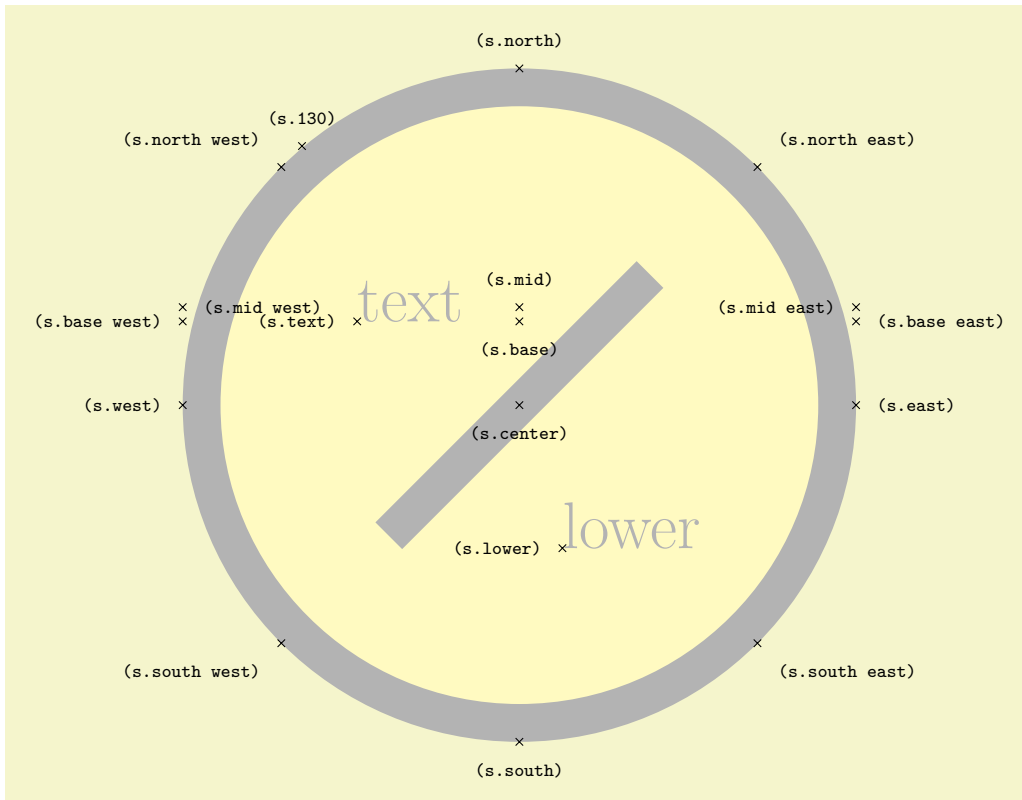

```

\Huge
\begin{tikzpicture}
  \node[name=s,shape=circle solidus,shape example,inner xsep=1cm] {text\nodepart{lower}lower};
  \foreach \anchor/\placement in
    {north west/above left, north/above, north east/above right,
     west/left, center/below, east/right,
     mid west/right, mid/above, mid east/left,
     base west/left, base/below, base east/right,
     south west/below left, south/below, south east/below right,
     text/left, lower/left, 130/above}
    \draw[shift=(s.\anchor)] plot[mark=x] coordinates{(0,0)}
      node[\placement] {\scriptsize\texttt{(s.\anchor)}};
\end{tikzpicture}

```

### Shape **ellipse split**

This shape is a multi-part shape consisting of an ellipse with a line in the middle. The upper part is the main part (the `text` part), the lower part is the `lower` part. The anchors for this shape are shown below. Anchor 60 is a border anchor.

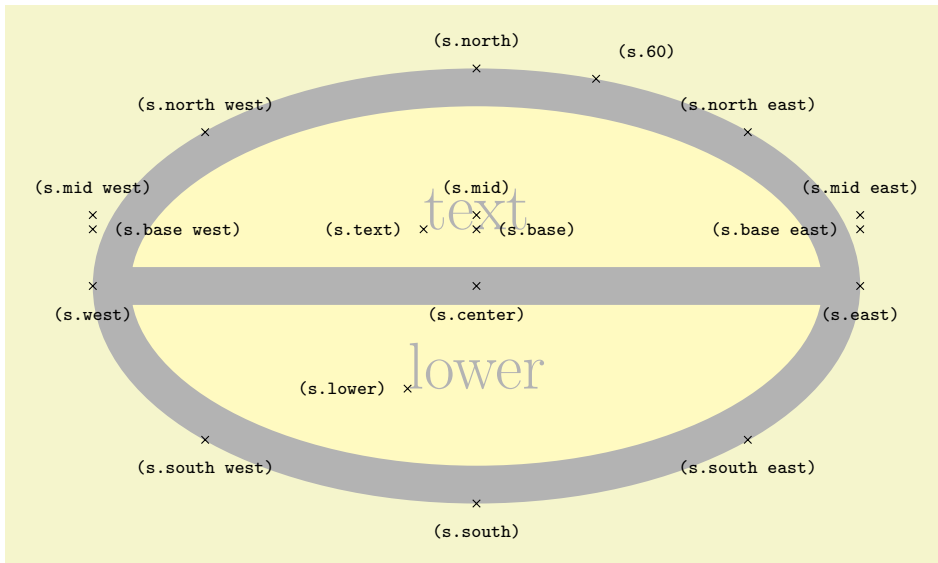

```

\Huge
\begin{tikzpicture}
  \node[name=s,shape=ellipse split,shape example] {text\nodepart{lower}lower};
  \foreach \anchor/\placement in
    {center/below, text/left, lower/left, 60/above right,
     mid/above, mid east/above, mid west/above,
     base/right, base east/left, base west/right,
     north/above, south/below, east/below, west/below,
     north east/above, south east/below, north west/above}
    \draw[shift=(s.\anchor)] plot[mark=x] coordinates{(0,0)}
      node[\placement] {\scriptsize\texttt{(s.\anchor)}};
\end{tikzpicture}

```

### Shape `rectangle split`

This shape is a rectangle which can be either split horizontally or vertically into several parts.

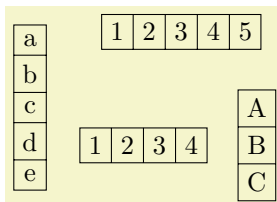

```

\begin{tikzpicture}[my shape/.style={
  rectangle split, rectangle split parts=#1, draw, anchor=center}]
  \node [my shape=5] at (0,1)
    {a\nodepart{two}b\nodepart{three}c\nodepart{four}d\nodepart{five}e};
  \node [my shape=5, rectangle split horizontal] at (2,2)
    {1\nodepart{two}2\nodepart{three}3\nodepart{four}4\nodepart{five}5};
  \node [my shape=3] at (3,0.5)
    {A\nodepart{two}B\nodepart{three}C};
  \node [my shape=4, rectangle split horizontal] at (1.5,0.5)
    {1\nodepart{two}2\nodepart{three}3\nodepart{four}4};
\end{tikzpicture}

```

The shape can be split into a maximum of twenty parts. However, to avoid allocating a lot of unnecessary boxes, PGF only allocates four boxes by default. To use the `rectangle split` shape with more than four boxes, the extra boxes must be allocated manually in advance (perhaps using `\newbox` or `\let`). The boxes take the form `\pgfnodepart<number>box`, where `<number>` is from the cardinal numbers one, two, three, ... and so on. `\pgfnodepartonebox` is special in that it is synonymous with `\pgfnodeparttextbox`. For compatibility with earlier versions of this shape, the boxes `\pgfnodeparttwo`, `\pgfnodepartthree` and `\pgfnodepartfour`, can be referred to using the ordinal numbers: `\pgfnodepartsecond`, `\pgfnodepartthird` and `\pgfnodepartfourth`. In order to facilitate the allocation of these extra boxes, the following key is provided:

`/pgf/rectangle split allocate boxes=<number>` (no default)

This key checks if `<number>` boxes have been allocated, and if not allocates the required boxes using `\newbox` (some “magic” is performed to get around the fact that `\newbox` is declared `\outer` in plain  $\TeX$ ).

When split vertically, the rectangle split will observe any `minimum width` requirements but any `minimum height` requirements

will be observed, but any `minimum width` will be ignored. In addition, `inner sep` is applied to every part that is used, so it cannot be specified independently for a particular part.

There are several PGF keys to specify how the shape is drawn. To use these keys in TikZ, simply remove the `/pgf/` path:

`/pgf/rectangle split parts=<number>` (no default, initially 4)

Split the rectangle into `<number>` parts, which should be in the range 1 to 20. If more than four parts are need, the boxes should be allocated in advance as described above.

|                  |
|------------------|
| Student          |
| age:int          |
| name:String      |
| getAge():int     |
| getName():String |

```
\begin{tikzpicture}[every text node part/.style={align=center}]
  \node[rectangle split, rectangle split parts=3, draw, text width=2.75cm]
  {Student
  \nodepart{two}
  age:int \\
  name:String
  \nodepart{three}
  getAge():int \\
  getName():String};
\end{tikzpicture}
```

`/pgf/rectangle split horizontal=<boolean>` (default true)

This key determines whether the rectangle is split horizontally or vertically

`/pgf/rectangle split ignore empty parts=<boolean>` (default true)

When `<boolean>` is true, PGF will ignore any part that is empty *except the text part*. This effectively overrides the `rectangle split parts` key in that, if 3 parts (for example) are specified, but one is empty, only two will be shown.

|       |       |
|-------|-------|
| text  | text  |
|       | third |
| third |       |

```
\begin{tikzpicture}[every node/.style={draw, anchor=text, rectangle split,
rectangle split parts=3}]
  \node {text \nodepart{second} \nodepart{third}third};
  \node [rectangle split ignore empty parts] at (2,0)
  {text \nodepart{second} \nodepart{third}third};
\end{tikzpicture}
```

`/pgf/rectangle split empty part width=<length>` (no default, initially 1ex)

Set the default width for a node part box if it is empty and empty parts are not ignored.

`/pgf/rectangle split empty part height=<length>` (no default, initially 1ex)

Set the default height for a node part box if it is empty and empty parts are not ignored.

`/pgf/rectangle split empty part depth=<length>` (no default, initially 0ex)

Set the default depth for a node part box if it is empty and empty parts are not ignored.

`/pgf/rectangle split part align={<list>}` (no default, initially center)

Set the alignment of the boxes inside the node parts. Each item in `<list>` should be separated by commas (so if there is more than one item in `<list>` it must be surrounded by braces).

When the rectangle is split vertically, the entries in `<list>` must be one of `left`, `right`, or `center`. If `<list>` has less entries than node parts then the remaining boxes are aligned according to the last entry in the list. Note that this only aligns the boxes in each part and *does not* affect the alignment of the contents of the boxes.

|       |       |       |
|-------|-------|-------|
| one   | one   | one   |
| 2     | 2     | 2     |
| three | three | three |
| 4     | 4     | 4     |

```
\def\x{one \nodepart{two} 2 \nodepart{three} three \nodepart{four} 4}
\begin{tikzpicture}[
every node/.style={rectangle split, rectangle split parts=4,
draw}
]
\node[rectangle split part align={center, left, right}] at (0,0) {\x};
\node[rectangle split part align={center, left}] at (1.25,0) {\x};
\node[rectangle split part align={center}] at (2.5,0) {\x};
\end{tikzpicture}
```

When the rectangle is split horizontally, the entries in  $\langle list \rangle$  must be one of `top`, `bottom`, `center` or `base`. Note that using the value `base` will only makes sense if all the node part boxes are being aligned in this way. This is because the `base` value aligns the boxes in relation to each other, whereas the other values align the boxes in relation to the part of the shape they occupy.

|   |   |   |   |
|---|---|---|---|
| w | x | y | z |
| w | x | y | z |
| w | x | y | z |
| w | x | y | z |

```

\def\x{\Large w\nodepart{two}x\nodepart{three}\Huge y\nodepart{four}\tiny z}
\begin{tikzpicture}
  every node/.style={rectangle split, rectangle split parts=4,
    draw, rectangle split horizontal}
]
  \node[rectangle split part align={center, top, bottom}] at (0,0) {\x};
  \node[rectangle split part align={center, top}] at (0,-1.25) {\x};
  \node[rectangle split part align={center}] at (0,-2.5) {\x};
  \node[rectangle split part align=base] at (0,-3.75) {\x};
\end{tikzpicture}

```

`/pgf/rectangle split draw splits= $\langle boolean \rangle$`  (default true) (no default)

Set whether the line or lines between node parts will be drawn. Internally, this sets the  $\TeX$ -if `\ifpgfrectanglesplitdrawsplits` appropriately.

`/pgf/rectangle split use custom fill= $\langle boolean \rangle$`  (default true)

This enables the use of a custom fill for each of the node parts (including the area covered by the `inner sep`). The background path for the shape should not be filled (e.g., in  $\TeX$ , the `fill` option for the node must be implicitly or explicitly set to `none`). Internally, this key sets the  $\TeX$ -if `\ifpgfrectanglesplitusecustomfill` appropriately.

`/pgf/rectangle split part fill= $\langle list \rangle$`  (no default, initially white)

Set the custom fill color for each node part shape. Each item in  $\langle list \rangle$  should be separated by commas (so if there is more than one item in  $\langle list \rangle$  it must be surrounded by braces). If  $\langle list \rangle$  has less entries than node parts then the remaining node parts use the color from the last entry in the list. This key will automatically set `/pgf/rectangle split use custom fill`.

|   |   |   |   |
|---|---|---|---|
| w | x | y | z |
| w | x | y | z |
| w | x | y | z |
| w | x | y | z |

```

\begin{tikzpicture}
  \tikzset{every node/.style={rectangle split, draw, minimum width=.5cm}}
  \node[rectangle split part fill={red!50, green!50, blue!50, yellow!50}] {};
  \node[rectangle split part fill={red!50, green!50, blue!50}] at (0.75,0) {};
  \node[rectangle split part fill={red!50, green!50}] at (1.5,0) {};
  \node[rectangle split part fill={red!50}] at (2.25,0) {};
\end{tikzpicture}

```

The anchors for the `rectangle split` shape split vertically into four, are shown below (anchor 70 is an example of a border angle). When a node part is missing, the anchors prefixed with name of that node part should be considered unavailable. They are (unavoidably) defined, but default to other anchor positions.



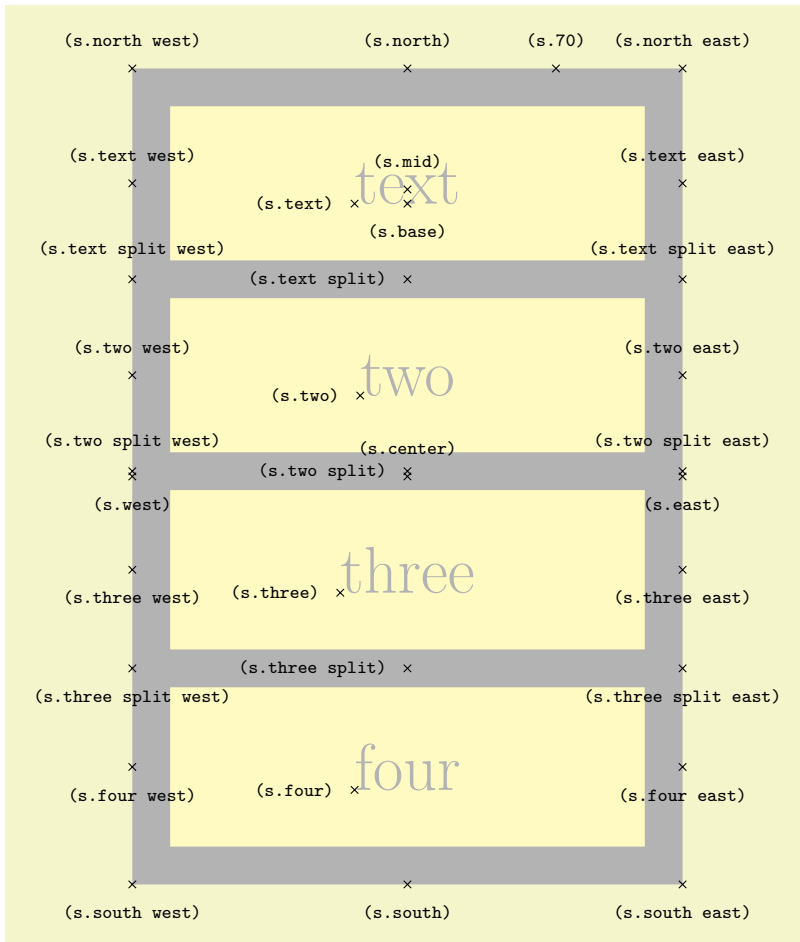

```

\Huge
\begin{tikzpicture}
  \node[name=s,shape=rectangle split, rectangle split parts=4, shape example,
        inner ysep=0.75cm]
    {\nodepart{text}text\nodepart{two}two
\nodepart{three}three\nodepart{four}four};
  \foreach \anchor/\placement in
    {text/left, text east/above, text west/above,
two/left, two east/above, two west/above,
three/left, three east/below, three west/below,
four/left, four east/below, four west/below,
text split/left, text split east/above, text split west/above,
two split/left, two split east/above, two split west/above,
three split/left, three split east/below, three split west/below,
north/above, south/below, east/below, west/below,
north west/above, north east/above, south west/below, south east/below,
center/above, 70/above, mid/above, base/below}
    \draw[shift=(s.\anchor)] plot[mark=x] coordinates{(0,0)}
      node[\placement] {\scriptsize\texttt{(s.\anchor)}};
\end{tikzpicture}

```

## 46.7 Callout Shapes

```

\usepgflibrary{shapes.callout} %  $\TeX$  and plain  $\TeX$  and pure pgf
\usepgflibrary[shapes.callout] % Con $\TeX$ t and pure pgf
\usetikzlibrary{shapes.callout} %  $\TeX$  and plain  $\TeX$  when using TikZ
\usetikzlibrary[shapes.callout] % Con $\TeX$ t when using TikZ

```

Producing basic callouts can be done quite easily in PGF and TikZ by creating a node and then subsequently drawing a path from the border of the node to the required point. This library provides more fancy, ‘balloon’-style callouts.

Callouts consist of a main shape, and a pointer (which is part of the shape) which points to something in (or outside) the picture. The position on the border of the main shape to which the pointer is connected is determined automatically. However, the pointer is ignored when calculating the minimum size of the shape, and also when positioning anchors.



```
\begin{tikzpicture}[remember picture]
\node[ellipse callout, draw] (hallo) {Hallo!};
\end{tikzpicture}
```

There are two kinds of pointer: the “relative” pointer and the “absolute” pointer. The relative pointer calculates the angle of a specified coordinate relative to the center of the main shape, locates the point on the border to which this angle corresponds, and then adds the coordinate to this point. This seemingly over-complex approach means that you do not have to guess the size of the main shape: the relative pointer will always be outside. The absolute pointer, on the other hand, is much simpler: it points to the specified coordinate absolutely (and can even point to named coordinates in different pictures).

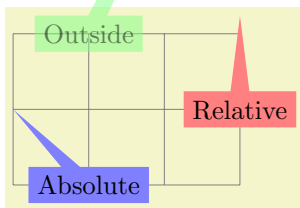

```
\begin{tikzpicture}[remember picture, note/.style={rectangle callout, fill=#1}]
\draw [help lines] grid(3,2);
\node [note=red!50, callout relative pointer={(0,1)}] at (3,1) {Relative};
\node [note=blue!50, callout absolute pointer={(0,1)}] at (1,0) {Absolute};
\node [note=green!50, opacity=.5, overlay,
callout absolute pointer={(hallo.south)}] at (1,2) {Outside};
\end{tikzpicture}
```

The following keys are common to all callouts. Please remember that the `callout relative pointer` and `callout absolute pointer` keys take a different format for their value depending on whether they are being used in PGF or TikZ.

`/pgf/callout relative pointer=<coordinate>` (no default, initially `\pgfpointpolar{315}{.5cm}`)

Set the vector of the callout pointer ‘relative’ to the callout shape.

`/pgf/callout absolute pointer=<coordinate>` (no default)

Set the vector of the callout pointer absolutely within the picture.

`/tikz/callout relative pointer=<coordinate>` (no default, initially `(315:.5cm)`)

The TikZ version of the `callout relative pointer` key. Here, `<coordinate>` can be specified using the TikZ format for coordinates.

`/tikz/callout absolute pointer=<coordinate>` (no default)

The TikZ version of the `callout absolute pointer` key. Here, `<coordinate>` can be specified using the TikZ format for coordinates.

It is also possible to shorten the pointer by some distance, using the following key:

`/pgf/callout pointer shorten=<distance>` (no default, initially `0cm`)

Move the callout pointer towards the center of the callouts main shape by `<distance>`.

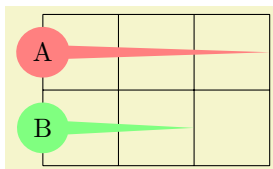

```
\begin{tikzpicture}
\tikzset{callout/.style={ellipse callout, callout pointer arc=30,
callout absolute pointer={#1}}}
\draw (0,0) grid (3,2);
\node[callout={(3,1.5)}, fill=red!50] at (0,1.5) {A};
\node[callout={(3,.5)}, fill=green!50, callout pointer shorten=1cm]
at (0,.5) {B};
\end{tikzpicture}
```

### Shape `rectangle callout`

This shape is a callout whose main shape is a rectangle, which tightly fits the node contents (including any `inner sep`). It supports the keys described above and also the following key:

`/pgf/callout pointer width=<length>` (no default, initially `.25cm`)

Set the width of the pointer at the border of the rectangle.

The anchors for this shape are shown below (anchor 60 is an example of a border anchor). The pointer direction is ignored when placing anchors. Additionally, when using an absolute pointer, the `pointer` anchor should not be used to position the shape as it is calculated whilst the shape is being drawn.

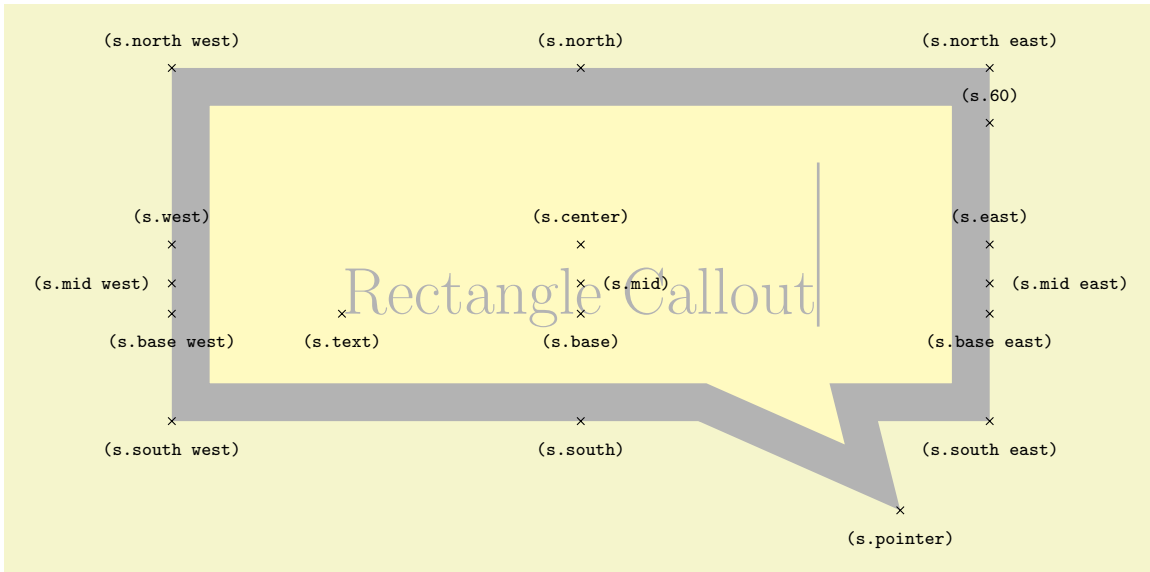

```
\Huge
\begin{tikzpicture}
  \node[name=s,shape=rectangle callout, callout relative pointer={{(1.25cm,-1cm)},
    callout pointer width=2cm, shape example, inner xsep=2cm, inner ysep=1cm}
    {Rectangle Callout\vrule width 1pt height 2cm};
  \foreach \anchor/\placement in
    {center/above, text/below, 60/above,
     mid/right, mid west/left, mid east/right,
     base/below, base west/below, base east/below,
     north/above, south/below, east/above, west/above,
     north west/above, north east/above,
     south west/below, south east/below,
     pointer/below}
    \draw[shift=(s.\anchor)] plot[mark=x] coordinates{(0,0)}
      node[\placement] {\scriptsize\texttt{(s.\anchor)}};
\end{tikzpicture}
```

### Shape `ellipse callout`

This shape is a callout whose main shape is a ellipse, which tightly fits the node contents (including any inner sep). It uses the absolute callout `pointer`, relative callout `pointer` and callout `pointer shorten` keys, and also the following key:

`/pgf/callout pointer arc= $\langle angle \rangle$`  (no default, initially 15)

Set the width of pointer at the border of the ellipse according to an arc of length  $\langle angle \rangle$ .

The anchors for this shape are shown below (anchor 60 is an example of a border anchor). The pointer direction is ignored when placing anchors and the `pointer` anchor can only be used to position the shape when the relative anchor is specified.

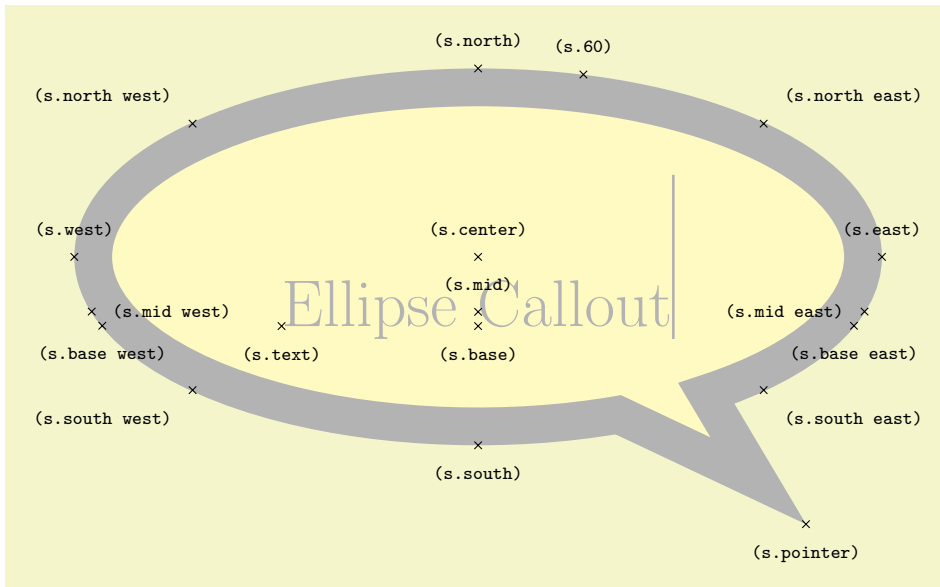

```

\Huge
\begin{tikzpicture}
\node[name=s,shape=ellipse callout, callout relative pointer={(1.25cm,-1cm)},
  callout pointer width=2cm, shape example, inner xsep=1cm, inner ysep=.5cm]
{Ellipse Callout\vrule width 1pt height 2cm};
\foreach \anchor/\placement in
{center/above, text/below, 60/above,
mid/above, mid west/right, mid east/left,
base/below, base west/below, base east/below,
north/above, south/below, east/above, west/above,
north west/above left, north east/above right,
south west/below left, south east/below right,
pointer/below}
\draw[shift=(s.\anchor)] plot[mark=x] coordinates{(0,0)}
node[\placement] {\scriptsize\texttt{(s.\anchor)}};
\end{tikzpicture}

```

### Shape cloud callout

This shape is a callout whose main shape is a cloud which fits the node contents. The pointer is segmented, consisting of a series of shrinking ellipses. This callout requires the symbol shape library (for the cloud shape). If this library is not loaded an error will result.



```

\begin{tikzpicture}
\node[cloud callout, cloud puffs=15, aspect=2.5, cloud puff arc=120,
  shading=ball,text=white] {\bf Imagine...};
\end{tikzpicture}

```

The cloud callout supports the `absolute callout pointer`, `relative callout pointer` and `callout pointer shorten` keys, as described above. The main shape can be modified using the same keys as the cloud shape. The following keys are also supported:

`/pgf/callout pointer start size=value` (no default, initially .2 of callout)

Set the size of the first segment in the pointer (i.e., the segment nearest the main cloud shape). There are three possible forms for *value*:

- A single dimension (e.g., 5pt), in which case the first ellipse will have equal diameters of 5pt.
- Two dimensions (e.g., 10pt and 2.5pt), which sets the *x* and *y* diameters of the first ellipse.
- A decimal fraction (e.g., .2 of callout), in which case the *x* and *y* diameters of the first ellipse will be set as fractions of the width and height of the main shape. The keyword of callout cannot be omitted.

`/pgf/callout pointer end size=value` (no default, initially .1 of callout)

Set the size of the last ellipse in the pointer.

`/pgf/callout pointer segments=<number>` (no default, initially 2)

Set the number of segments in the pointer. Note that PGF will happily overlap segments if too many are specified.

The anchors for this shape are shown below (anchor 70 is an example of a border anchor). The pointer direction is ignored when placing anchors and the pointer anchor can only be used to position the shape when the relative anchor is specified. Note that the center of the last segment is drawn at the `pointer` anchor.

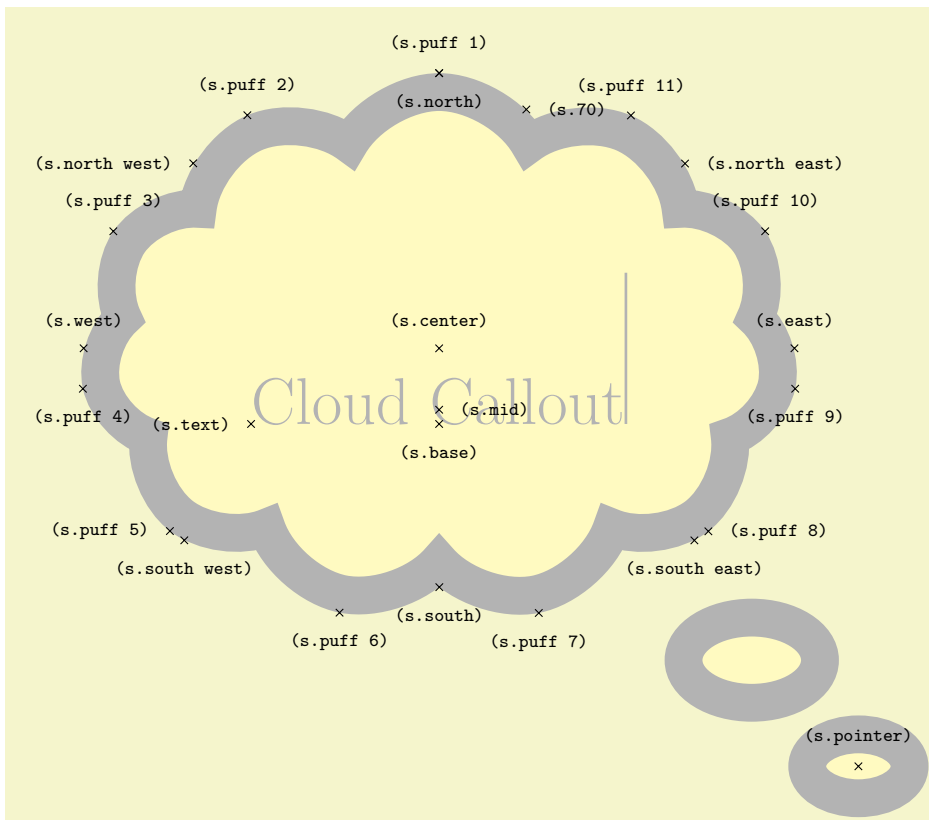

```
\Huge
\begin{tikzpicture}
  \node[name=s, shape=cloud callout, style=shape example, cloud puffs=11, aspect=1.5,
    cloud puff arc=120,inner xsep=.5cm, callout pointer start size=.25 of callout,
    callout pointer end size=.15 of callout, callout relative pointer={(315:4cm)},
    callout pointer segments=2] {Cloud Callout\vrule width 1pt height 2cm};
  \foreach \anchor/\placement in
  {puff 1/above, puff 2/above, puff 3/above, puff 4/below,
    puff 5/left, puff 6/below, puff 7/below, puff 8/right,
    puff 9/below, puff 10/above, puff 11/above, 70/right,
    center/above, base/below, mid/right, text/left,
    north/below, south/below, east/above, west/above,
    north west/left, north east/right,
    south west/below, south east/below,pointer/above}
  \draw[shift=(s.\anchor)] plot[mark=x] coordinates{(0,0)}
    node[\placement] {\scriptsize\texttt{(s.\anchor)}};
\end{tikzpicture}
```

## 46.8 Miscellaneous Shapes

```
\usepgflibrary{shapes.misc} % LATEX and plain TEX and pure pgf
\usepgflibrary[shapes.misc] % ConTEXt and pure pgf
\usetikzlibrary{shapes.misc} % LATEX and plain TEX when using TikZ
\usetikzlibrary[shapes.misc] % ConTEXt when using TikZ
```

This library defines general-purpose shapes that do not fit in the previous categories.

## Shape `cross out`

This shape “crosses out” the node. Its foreground path are simply two diagonal lines that between the corners of the node’s bounding box. Here is an example:

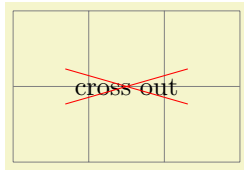

```
\begin{tikzpicture}
\draw [help lines] (0,0) grid (3,2);
\node [cross out,draw=red] at (1.5,1) {cross out};
\end{tikzpicture}
```

A useful application is inside text as in the following example:

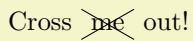

```
Cross \tikz[baseline] \node [cross out,draw,anchor=text] {me}; out!
```

This shape inherits all anchors from the `rectangle` shape, see also the following figure:

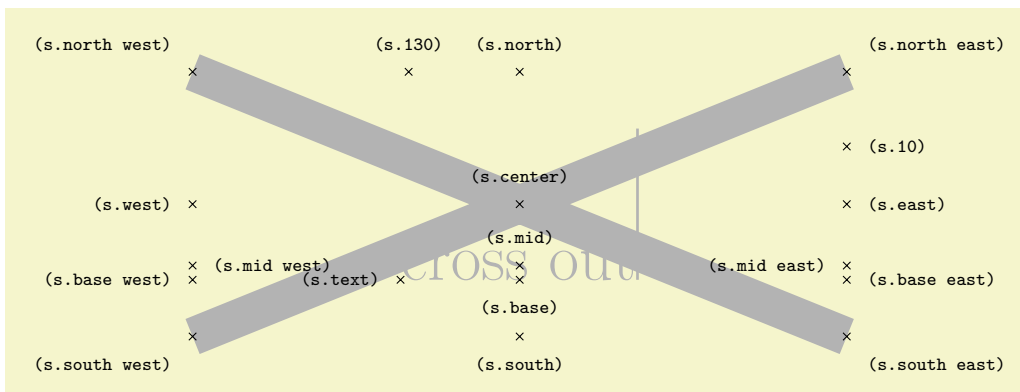

```
\Huge
\begin{tikzpicture}
\node[name=s,shape=cross out,shape example] {cross out\vrule width 1pt height 2cm};
\foreach \anchor/\placement in
{north west/above left, north/above, north east/above right,
west/left, center/above, east/right,
mid west/right, mid/above, mid east/left,
base west/left, base/below, base east/right,
south west/below left, south/below, south east/below right,
text/left, 10/right, 130/above}
\draw[shift=(s.\anchor)] plot[mark=x] coordinates{(0,0)}
\node[\placement] {\scriptsize\texttt{(s.\anchor)}};
\end{tikzpicture}
```

## Shape `cross out`

This shape “crosses out” the node. Its foreground path are simply two diagonal lines that between the corners of the node’s bounding box. Here is an example:

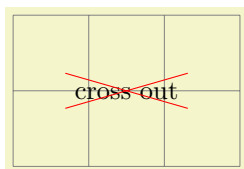

```
\begin{tikzpicture}
\draw [help lines] (0,0) grid (3,2);
\node [cross out,draw=red] at (1.5,1) {cross out};
\end{tikzpicture}
```

A useful application is inside text as in the following example:

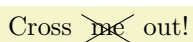

```
Cross \tikz[baseline] \node [cross out,draw,anchor=text] {me}; out!
```

This shape inherits all anchors from the `rectangle` shape, see also the following figure:

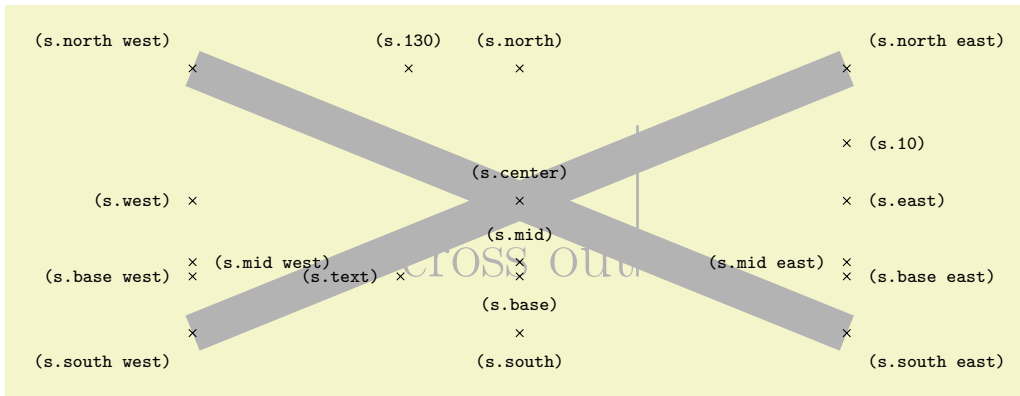

```

\Huge
\begin{tikzpicture}
\node[name=s,shape=cross out,shape example] {cross out\vrule width 1pt height 2cm};
\foreach \anchor/\placement in
{north west/above left, north/above, north east/above right,
west/left, center/above, east/right,
mid west/right, mid/above, mid east/left,
base west/left, base/below, base east/right,
south west/below left, south/below, south east/below right,
text/left, 10/right, 130/above}
\draw[shift=(s.\anchor)] plot[mark=x] coordinates{(0,0)}
node[\placement] {\scriptsize\texttt{(s.\anchor)}};
\end{tikzpicture}

```

Shape **strike out**

This shape is identical to the **cross out** shape, only its foreground path consists of a single line from the lower left to the upper right.

```

Strike me out! \Strike \tikz[baseline] \node [strike out,draw,anchor=text] {me}; out!

```

See the **cross out** shape for the anchors.

Shape **rounded rectangle**

This shape is a rectangle which can be optionally round sides.

```

Hallo \begin{tikzpicture}
\node[rounded rectangle, draw, fill=red!20]{Hallo};
\end{tikzpicture}

```

There are keys to specify how the sides are rounded (to use these keys in TikZ, simply remove the `/pgf/` path).

`/pgf/rounded rectangle arc length=angle` (no default, initially 180)

Set the length of the arcs for the rounded ends. Recommended values for *angle* are between 90 and 180.



```

180 \begin{tikzpicture}
120 \matrix[row sep=5pt, every node/.style={draw, rounded rectangle}]{
90 \node[rounded rectangle arc length=180] {180}; \\
\node[rounded rectangle arc length=120] {120}; \\
\node[rounded rectangle arc length=90] {90}; \\
\end{tikzpicture}

```

`/pgf/rounded rectangle west arc=arc type` (no default, initially convex)

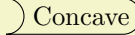
Set the style of the rounding for the left side. The permitted values for *arc type* are **concave**, **convex**, or **none**.

|                                                                                                                                                                                                                                                                                 |                                                                                                                                                                                                                                                                                                       |
|---------------------------------------------------------------------------------------------------------------------------------------------------------------------------------------------------------------------------------------------------------------------------------|-------------------------------------------------------------------------------------------------------------------------------------------------------------------------------------------------------------------------------------------------------------------------------------------------------|
|  Concave<br> Convex<br> None | <pre>\begin{tikzpicture}   \matrix[row sep=5pt, every node/.style={draw, rounded rectangle}]{     \node[rounded rectangle west arc=concave] {Concave}; \\     \node[rounded rectangle west arc=convex] {Convex}; \\     \node[rounded rectangle left arc=none] {None}; \\   } \end{tikzpicture}</pre> |
|---------------------------------------------------------------------------------------------------------------------------------------------------------------------------------------------------------------------------------------------------------------------------------|-------------------------------------------------------------------------------------------------------------------------------------------------------------------------------------------------------------------------------------------------------------------------------------------------------|

`/pgf/rounded rectangle left arc=<arc type>` (style, no default)

Alternative key for specifying the west arc.

`/pgf/rounded rectangle east arc=<arc type>` (no default, initially convex)

Set the style of the rounding for the east side.

`/pgf/rounded rectangle right arc=<arc type>` (style, no default)

Alternative key for specifying the east arc.

The anchors for this shape are shown below (anchor 10 is an example of a border angle). Note that if only one side is rounded, the center anchor will not be the precise center of the shape.

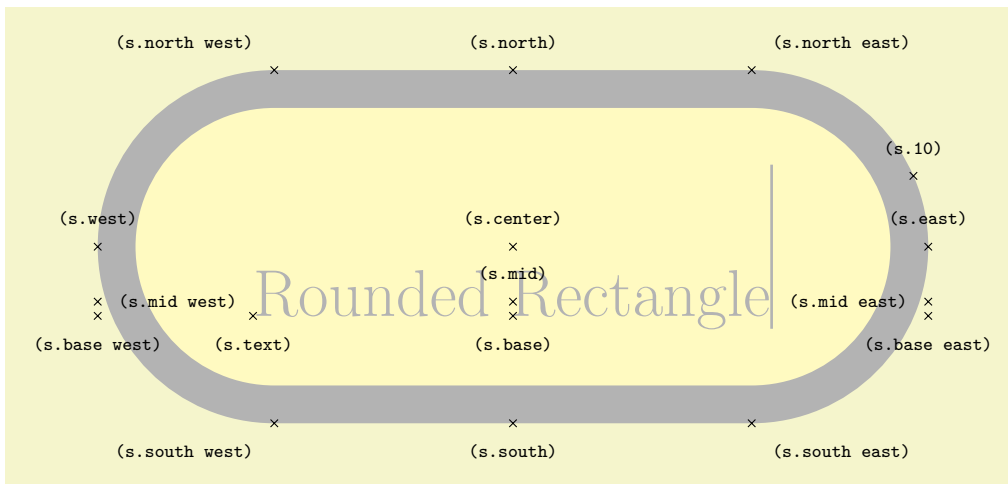

```
\Huge
\begin{tikzpicture}
  \node[name=s,shape=rounded rectangle, shape example, inner xsep=1.5cm, inner ysep=1cm]
  {Rounded Rectangle\vrule width 1pt height 2cm};
  \foreach \anchor/\placement in
  {center/above, text/below, 10/above,
  mid/above, mid west/right, mid east/left,
  base/below, base west/below, base east/below,
  north/above, south/below, east/above, west/above,
  north west/above left, north east/above right,
  south west/below left, south east/below right}
  \draw[shift=(s.\anchor)] plot[mark=x] coordinates{(0,0)}
  node[\placement] {\scriptsize\texttt{(s.\anchor)}};
\end{tikzpicture}
```

### Shape `chamfered rectangle`

This shape is a rectangle with optionally chamfered corners.

|                                                                                     |                                                                                                                                             |
|-------------------------------------------------------------------------------------|---------------------------------------------------------------------------------------------------------------------------------------------|
|  | <pre>\begin{tikzpicture}   \node[chamfered rectangle, white, fill=red, double=red, draw, very thick]   {\bf STOP!}; \end{tikzpicture}</pre> |
|-------------------------------------------------------------------------------------|---------------------------------------------------------------------------------------------------------------------------------------------|

There are PGF keys to specify how this shape is drawn (to use these keys in TikZ simply remove the `/pgf/` path).

`/pgf/chamfered rectangle angle=<angle>` (no default, initially 45)

Set the angle *from the vertical* for the chamfer.



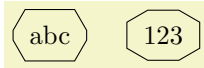

```
\begin{tikzpicture}
\tikzset{every node/.style={chamfered rectangle, draw}}
\node[chamfered rectangle angle=30] {abc};
\node[chamfered rectangle angle=60] at (1.5,0) {123};
\end{tikzpicture}
```

`/pgf/chamfered rectangle xsep= $\langle length \rangle$`  (no default, initially `.666ex`)

Set the distance that the chamfer extends horizontally beyond the node contents (which includes the `inner sep`). If  $\langle length \rangle$  is large, such that the top and bottom chamfered edges would cross, then  $\langle length \rangle$  is ignored and the chamfered edges are drawn so that they meet in the middle.

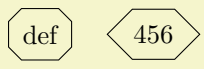

```
\begin{tikzpicture}
\tikzset{every node/.style={chamfered rectangle, draw}}
\node[chamfered rectangle xsep=2pt] {def};
\node[chamfered rectangle xsep=2cm] at (1.5,0) {456};
\end{tikzpicture}
```

`/pgf/chamfered rectangle ysep= $\langle length \rangle$`  (no default, initially `.666ex`)

Set the distance that the chamfer extends vertically beyond the node contents. If  $\langle length \rangle$  is large, such that the left and right chamfered edges would cross, then  $\langle length \rangle$  is ignored and the chamfered edges are drawn so that they meet in the middle.

`/pgf/chamfered rectangle sep= $\langle length \rangle$`  (no default, initially `.666ex`)

Set both the `xsep` and `ysep` simultaneously.

`/pgf/chamfered rectangle corners= $\langle list \rangle$`  (no default, initially `chamfer all`)

Specify which corners are chamfered. The corners are identified by their “compass point” directions (i.e. `north east`, `north west`, `south west`, and `south east`), and must be separated by commas (so if there is more than one corner in the list, it must be surrounded by braces). Any corners not mentioned in  $\langle list \rangle$  are automatically not chamfered. Two additional values `chamfer all` and `chamfer none`, are also permitted.



```
\begin{tikzpicture}
\tikzset{every node/.style={chamfered rectangle, draw}}
\node[chamfered rectangle corners=north west] {ghi};
\node[chamfered rectangle corners={north east, south east}] at (1.5,0) {789};
\end{tikzpicture}
```

The anchors for this shape are shown below (anchor `60` is an example of a border angle).

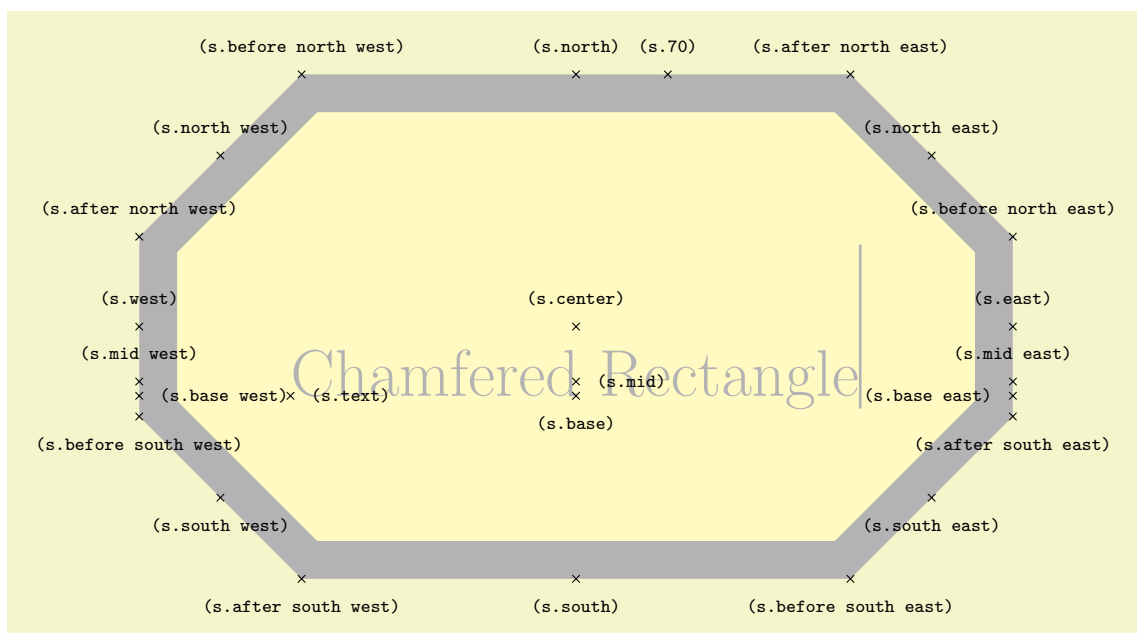

```

\Huge
\begin{tikzpicture}
  \node[name=s,shape=chamfered rectangle, chamfered rectangle sep=1cm,
        shape example, inner ysep=1cm, inner xsep=.75cm]
    {Chamfered Rectangle\vrule width1pt height2cm};
  \foreach \anchor/\placement in
    {text/right, center/above, 70/above,
     base/below, base east/left, base west/right,
     mid/right, mid east/above, mid west/above,
     north/above, south/below, east/above, west/above,
     before north east/above, north east/above, after north east/above,
     before north west/above, north west/above, after north west/above,
     before south west/below, south west/below, after south west/below,
     before south east/below, south east/below, after south east/below}
    \draw[shift=(s.\anchor)] plot[mark=x] coordinates{(0,0)}
      node[\placement] {\scriptsize\texttt{(s.\anchor)}};
\end{tikzpicture}

```



## 48 To Path Library

```
\usetikzlibrary{topaths} %  $\TeX$  and plain  $\TeX$   
\usetikzlibrary[topaths] % Con $\TeX$ t
```

This library provides predefined to paths for use with the `to` path operation. After loading this package, you can say for instance `to [loop]` to add a loop to a node.

This library is loaded automatically by *TikZ*, so you do not need to load it yourself.

### 48.1 Straight Lines

The following style installs a `to` path that is simply a straight line from the start coordinate to the target coordinate.

```
/tikz/line to (no value)
```

Causes a straight line to be added to the path upon a `to` or an `edge` operation.



```
\tikz {\draw (0,0) to[line to] (1,0);}
```

### 48.2 Move-Tos

The following style installs a `to` path that simply “jumps” to the target coordinate.

```
/tikz/move to (no value)
```

Causes a move to be added to the path upon a `to` or an `edge` operation.

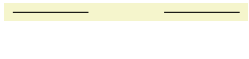

```
\tikz \draw (0,0) to[line to] (1,0)  
to[move to] (2,0) to[line to] (3,0);
```

### 48.3 Curves

The `curve to` style causes the `to` path to be set to a curve. The exact way this curve looks can be influenced via a number of options.

```
/tikz/curve to (no value)
```

Specifies that the `to path` should be a curve. This curve will leave the start coordinate at a certain angle, which can be specified using the `out` option. It reaches the target coordinate also at a certain angle, which is specified using the `in` option. The control points of the curve are at a certain distance that is computed in different ways, depending on which options are set.

All of the following options implicitly cause the `curve to` style to be installed.

```
/tikz/out= $\langle$ angle $\rangle$  (no default)
```

The angle at which the curve leaves the start coordinate. If the start coordinate is a node, the start coordinate is the point on the border of the node at the given  $\langle$ angle $\rangle$ . The control point will, thus, lie at a certain distance in the direction  $\langle$ angle $\rangle$  from the start coordinate.



```
\begin{tikzpicture}[out=45,in=135]  
  \draw (0,0) to (1,0)  
        (0,0) to (2,0)  
        (0,0) to (3,0);  
\end{tikzpicture}
```

```
/tikz/in= $\langle$ angle $\rangle$  (no default)
```

The angle at which the curve reaches the target coordinate.

```
/tikz/relative= $\langle$ true or false $\rangle$  (default true)
```

This option tells *TikZ* whether the `in` and `out` angles should be considered absolute or relative. Absolute means that an `out` angle of  $30^\circ$  means that the curve leaves the start coordinate at an angle of  $30^\circ$  relative to the paper (unless, of course, further transformations have been installed).

A *relative* angle is, by comparison, measured relative to a straight line from the start coordinate to the target coordinate. Thus, a relative angle of  $30^\circ$  means that the curve will bend to the left from the line going straight from the start to the target. For the target, the relative coordinate is measured in the same manner, namely relative to the line going from the start to the target. Thus, an angle of  $150^\circ$  means that the curve will reach target coming slightly from the left.

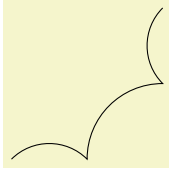

```
\begin{tikzpicture}[out=45,in=135,relative]
\draw (0,0) to (1,0)
to (2,1)
to (2,2);
\end{tikzpicture}
```

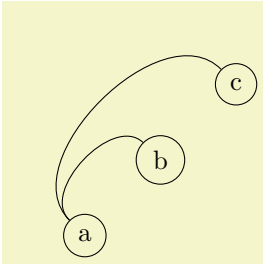

```
\begin{tikzpicture}[out=90,in=90,relative]
\node [circle,draw] (a) at (0,0) {a};
\node [circle,draw] (b) at (1,1) {b};
\node [circle,draw] (c) at (2,2) {c};

\path (a) edge (b)
edge (c);
\end{tikzpicture}
```

`/tikz/bend left= $\langle angle \rangle$`

(default last value)

This option sets `out= $\langle angle \rangle$ ,in=180 -  $\langle angle \rangle$ ,relative`. If no  $\langle angle \rangle$  is given, the last given `bend left` or `bend right` angle is used.

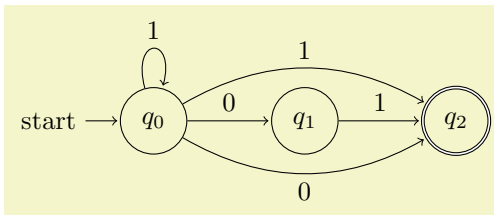

```
\begin{tikzpicture}[shorten >=1pt,node distance=2cm,on grid]
\node[state,initial] (q_0) {$q_0$};
\node[state] (q_1) [right=of q_0] {$q_1$};
\node[state,accepting] (q_2) [right=of q_1] {$q_2$};

\path[->] (q_0) edge node [above] {0} (q_1)
edge [loop above] node {1} ()
edge [bend left] node [above] {1} (q_2)
edge [bend right] node [below] {0} (q_2)
(q_1) edge node [above] {1} (q_2);
\end{tikzpicture}
```

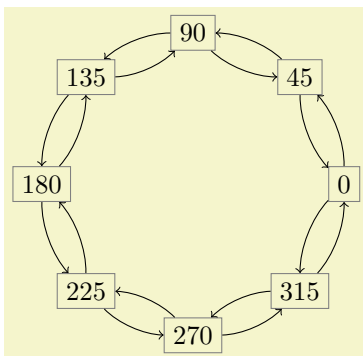

```

\begin{tikzpicture}
\foreach \angle in {0,45,...,315}
  \node[rectangle,draw=black!50] (\angle) at (\angle:2) {\angle};

\foreach \from/\to in {0/45,45/90,90/135,135/180,
  180/225,225/270,270/315,315/0}
  \path (\from) edge [->,bend right=22,looseness=0.8] (\to)
    edge [<-,bend left=22,looseness=0.8] (\to);
\end{tikzpicture}

```

`/tikz/bend right= $\langle angle \rangle$`  (default last value)

Works like the `bend left` option, only the bend is to the other side.

`/tikz/bend angle= $\langle angle \rangle$`  (no default)

Sets the angle to be used by the `bend left` or `bend right`, but without actually selecting the curve to or the `relative` option. This is useful for globally specifying a `bend angle` for a whole picture.

`/tikz/looseness= $\langle number \rangle$`  (no default, initially 1)

This number specifies how “loose” the curve will be. In detail, the following happens: *TikZ* computes the distance between the start and the target coordinate (if the start and/or target coordinate are nodes, the distance is computed between the points on their border). This distance is then multiplied by a fixed factor and also by the factor  $\langle number \rangle$ . The resulting distance, let us call it  $d$ , is then used as the distance of the control points from the start and target coordinates.

The fixed factor has been chosen in such a way that if  $\langle number \rangle$  is 1, if the `in` and `out` angles differ by  $90^\circ$ , then a quarter circle results:

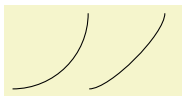

```

\tikz \draw (0,0) to [out=0,in=-90] (1,1);
\tikz \draw (0,0) to [out=0,in=-90,looseness=0.5] (1,1);

```

`/tikz/out looseness= $\langle number \rangle$`  (no default)

specifies the looseness factor for the out distance only.

`/tikz/in looseness= $\langle number \rangle$`  (no default)

specifies the looseness factor for the in distance only.

`/tikz/min distance= $\langle distance \rangle$`  (no default)

If the computed distance for the start and target coordinates are below  $\langle distance \rangle$ , then  $\langle distance \rangle$  is used instead.

`/tikz/max distance= $\langle distance \rangle$`  (no default)

If the computed distance for the start and target coordinates are above  $\langle distance \rangle$ , then  $\langle distance \rangle$  is used instead.

`/tikz/out min distance= $\langle distance \rangle$`  (no default)

The minimum distance set only for the start coordinate.

`/tikz/out max distance= $\langle distance \rangle$`  (no default)

The maximum distance set only for the start coordinate.

`/tikz/in min distance= $\langle distance \rangle$`  (no default)

The min distance set only for the target coordinate.

`/tikz/in max distance= $\langle distance \rangle$`  (no default)

The max distance set only for the target coordinate.

`/tikz/distance= $\langle distance \rangle$`  (no default)

Set the min and max distance to the same value (*distance*). Note that this causes any computed distance *d* to be ignored and (*distance*) to be used instead.

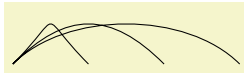

```
\begin{tikzpicture}[out=45,in=135,distance=1cm]
\draw (0,0) to (1,0)
(0,0) to (2,0)
(0,0) to (3,0);
\end{tikzpicture}
```

**/tikz/out distance**=*(distance)* (no default)

Sets the min and max out distance.

**/tikz/in distance**=*(distance)* (no default)

Sets the min and max in distance.

**/tikz/out control**=*(coordinate)* (no default)

This option causes the *(coordinate)* to be used as the start control point. All computations of *d* are ignored. You can use a coordinate like  $(1,0)$  to specify a point relative to the start coordinate.

**/tikz/in control**=*(coordinate)* (no default)

This option causes the *(coordinate)* to be used as the target control point.

**/tikz/controls**=*(coordinate)* and *(coordinate)* (no default)

This option causes the *(coordinate)*s to be used as control points.

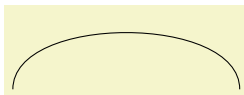

```
\tikz \draw (0,0) to [controls=+(90:1) and +(90:1)] (3,0);
```

## 48.4 Loops

**/tikz/loop** (no value)

This key is similar to the `curve to` key, but differs in the following ways: First, the actual target coordinate is ignored and the start coordinate is used as the target coordinate. Thus, it is allowed not to provide any target coordinate, which can be useful with unnamed nodes. Second, the `looseness` is set to 8 and the `min distance` to 5mm. These settings result in rather nice loops when the opening angle (difference between in and out) is 30°.



```
\begin{tikzpicture}
\node [circle,draw] {a} edge [in=30,out=60,loop] ();
\end{tikzpicture}
```

**/tikz/loop above** (style, no value)

Sets the `loop` style and sets in and out angles such that loop is above the node. Furthermore, the `above` option is set, which causes a node label to be placed at the correct position.

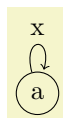

```
\begin{tikzpicture}
\node [circle,draw] {a} edge [loop above] node {x} ();
\end{tikzpicture}
```

**/tikz/loop below** (style, no value)

Works like the previous option.

**/tikz/loop left** (style, no value)

Works like the previous option.

**/tikz/loop right** (style, no value)

Works like the previous option.

`/tikz/every loop`

(style, initially ->, shorten >=1pt)

This style is installed at the beginning of every loop.



```
\begin{tikzpicture}[every loop/.style={}]
  \draw (0,0) to [loop above] () to [loop right] ()
            to [loop below] () to [loop left] ();
\end{tikzpicture}
```



## 49 Through Library

```
\usetikzlibrary{through} %  $\LaTeX$  and plain  $\TeX$   
\usetikzlibrary[through] % Con $\TeX$ t
```

This library defines keys for creating shapes that go through given points.

```
/tikz/circle through= $\langle$ coordinate $\rangle$  (no default)
```

When this key is given as an option to a node, the following happens:

1. The `inner sep` and the `outer sep` are set to zero.
2. The shape is set to `circle`.
3. The `minimum size` is set such that the circle around the center of the node (which is specified using `at`), goes through  $\langle$ coordinate $\rangle$ .

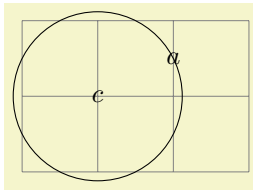

```
\begin{tikzpicture}  
  \draw[help lines] (0,0) grid (3,2);  
  \node (a) at (2,1.5) {$a$};  
  \node [draw] at (1,1) [circle through={(a)}] {$c$};  
\end{tikzpicture}
```

## 50 Tree Library

```
\usetikzlibrary{trees} %  $\LaTeX$  and plain  $\TeX$ 
\usetikzlibrary[trees] % Con $\TeX$ t
```

This packages defines styles to be used when drawing trees.

### 50.1 Growth Functions

The package `pgflibrarytikztrees` defines two new growth functions. They are installed using the following options:

```
/tikz/grow via three points=one child at ( $\langle x \rangle$ ) and two children at ( $\langle y \rangle$ ) and ( $\langle z \rangle$ ) (no default)
```

This option installs a growth function that works as follows: If a parent node has just one child, this child is placed at  $\langle x \rangle$ . If the parent node has two children, these are placed at  $\langle y \rangle$  and  $\langle z \rangle$ . If the parent node has more than two children, the children are placed at points that are linearly extrapolated from the three points  $\langle x \rangle$ ,  $\langle y \rangle$ , and  $\langle z \rangle$ . In detail, the position is  $x + \frac{n-1}{2}(y-x) + (c-1)(z-y)$ , where  $n$  is the number of children and  $c$  is the number of the current child (starting with 1).

The net effect of all this is that if you have a certain “linear arrangement” in mind and use this option to specify the placement of a single child and of two children, then any number of children will be placed correctly.

Here are some arrangements based on this growth function. We start with a simple “above” arrangement:

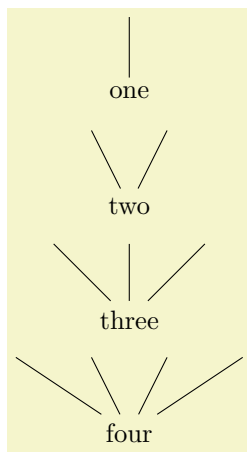

```
\begin{tikzpicture}[grow via three points={%
  one child at (0,1) and two children at (-.5,1) and (.5,1)}]
  \node at (0,0) {one} child;
  \node at (0,-1.5) {two} child child;
  \node at (0,-3) {three} child child child;
  \node at (0,-4.5) {four} child child child child;
\end{tikzpicture}
```

The next arrangement places children above, but “grows only to the right.”

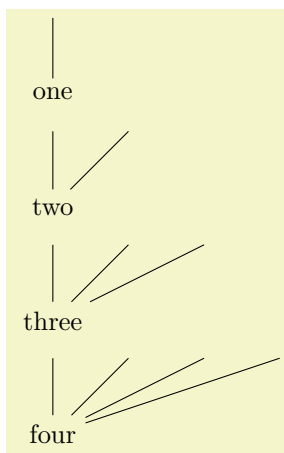

```
\begin{tikzpicture}[grow via three points={%
  one child at (0,1) and two children at (0,1) and (1,1)}]
  \node at (0,0) {one} child;
  \node at (0,-1.5) {two} child child;
  \node at (0,-3) {three} child child child;
  \node at (0,-4.5) {four} child child child child;
\end{tikzpicture}
```

In the final arrangement, the children are placed along a line going down and right.

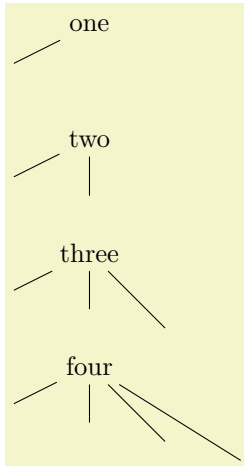

```
\begin{tikzpicture}[grow via three points={%
  one child at (-1,-.5) and two children at (-1,-.5) and (0,-.75)}]
  \node at (0,0) {one} child;
  \node at (0,-1.5) {two} child child;
  \node at (0,-3) {three} child child child;
  \node at (0,-4.5) {four} child child child child;
\end{tikzpicture}
```

These examples should make it clear how you can create new styles to arrange your children along a line.

**/tikz/grow cyclic** (no value)

This style causes the children to be arranged “on a circle.” For this, the children are placed at distance `\tikzleveldistance` from the parent node, but not on a straight line, but points on a circle. Instead of a sibling distance, there is a `sibling angle` that denotes the angle between two given children.

**/tikz/sibling angle=*angle*** (no default)

Sets the angle between siblings in the `grow cyclic` style.

Note that this function will rotate the coordinate system of the children to ensure that the grandchildren will grow in the right direction.

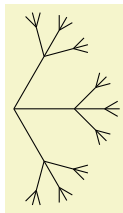

```
\begin{tikzpicture}
  [grow cyclic,
  level 1/.style={level distance=8mm,sibling angle=60},
  level 2/.style={level distance=4mm,sibling angle=45},
  level 3/.style={level distance=2mm,sibling angle=30}]
  \coordinate [rotate=-90] % going down
  child foreach \x in {1,2,3}
  {child foreach \x in {1,2,3}
  {child foreach \x in {1,2,3}}};
\end{tikzpicture}
```

**/tikz/clockwise from=*angle*** (no default)

This option also causes children to be arranged on a circle. However, the rule for placing children is simpler than with the `grow cyclic` style: The first child is placed at *angle* at a distance of `\tikzleveldistance`. The second child is placed at the same distance from the parent, but at angle  $\langle angle \rangle - \text{\tikzsiblingangle}$ . The third child is displaced by another `\tikzsiblingangle` in a clockwise fashion, and so on.

Note that this function will not rotate the coordinate system.

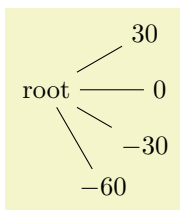

```
\begin{tikzpicture}
  \node {root}
  [clockwise from=30,sibling angle=30]
  child {node {$30$}}
  child {node {$0$}}
  child {node {$-30$}}
  child {node {$-60$}};
\end{tikzpicture}
```

**/tikz/counterclockwise from=*angle*** (no default)

Works the same way as `clockwise from`, but sibling angles are added instead of subtracted.

## 50.2 Edges From Parent

The following styles can be used to modify how the edges from parents are drawn:

`/tikz/edge from parent fork down`

(style, no value)

This style will draw a line from the parent downwards (for half the level distance) and then on to the child using only horizontal and vertical lines.

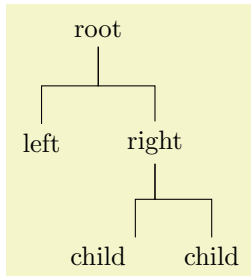

```
\begin{tikzpicture}
\node {root}
[edge from parent fork down]
child {node {left}}
child {node {right}}
child[child anchor=north east] {node {child}}
child {node {child}}
};
\end{tikzpicture}
```

`/tikz/edge from parent fork right`

(style, no value)

This style behaves similarly, only it will first draw its edge to the right.

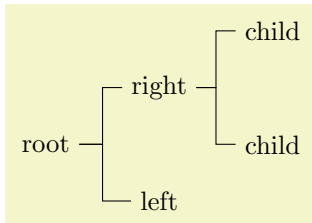

```
\begin{tikzpicture}
\node {root}
[edge from parent fork right,grow=right]
child {node {left}}
child {node {right}}
child {node {child}}
child {node {child}}
};
\end{tikzpicture}
```

`/tikz/edge from parent fork left`

(style, no value)

Behaves similarly to the previous styles.

`/tikz/edge from parent fork up`

(style, no value)

Behaves similarly to the previous styles.

## 51 Turtle Graphics Library

```
\usepgflibrary{turtle} %  $\TeX$  and plain  $\TeX$  and pure pgf
\usepgflibrary[turtle] % Con $\TeX$ t and pure pgf
\usetikzlibrary{turtle} %  $\TeX$  and plain  $\TeX$  when using TikZ
\usetikzlibrary[turtle] % Con $\TeX$ t when using TikZ
```

This little library defines some keys to create simple turtle graphics in the tradition of the Logo programming language. These commands are mostly for fun, but they can also be used for more “serious” business.

```
 \tikz[turtle/distance=2mm]
\draw [turtle={home,forward,right,forward,left,forward,left,forward}];
```

Even though the `turtle` keys looks like an option, it uses the `insert path` option internally to produce a path.

The basic drawing model behind the turtle graphics is very simple: There is a (virtual) *turtle* that crawls around the page, thereby extending the path. The turtle always heads in a certain direction. When you move the turtle forward you extend the path in that direction; turning the turtle just changes the direction, it does not cause anything to be drawn.

The turtle always moves relative to the last current point of the path and you can mix normal path commands with turtle commands. However, the direction of the turtle is managed independently of other path commands.

`/tikz/turtle=<keys>` (no default)

This key executes the `<keys>` with the current key path set to `/tikz/turtle`.

```
 \tikz[turtle/distance=2mm]
\draw [turtle={home,fd,rt,fd,lt,fd,lt,fd}];
```

`/tikz/turtle/home` (no value)

Places the turtle at the origin and lets it head upward.

`/tikz/turtle/forward=<distance>` (default see text)

Makes the turtle move forward by the given `<distance>`. If no `<distance>` is specified, the current value of the following key is used:

`/tikz/turtle/distance=<distance>` (no default, initially 1cm)

The default distance by which the turtle advances.

“Moving forward the turtle” actually means that, relative to the current last point on the path, a point at the given `<distance>` in the direction the turtle is currently heading is computed. Then, the operation `to[turtle/how]` is used to extend the path to this point.

`/tikz/turtle/how` (style, initially empty)

This style can setup the `to` path used by turtles. By setting this style you can change the to-path:

```
 \tikz \draw [turtle={how/.style={bend left},home,forward,right,forward}];
```

`/tikz/turtle/fd` (no value)

An abbreviation for the `forward` key.

`/tikz/turtle/back=<distance>` (default see text)

This has the same effect as a `turtle/forward` for the negated `<distance>` value.

`/tikz/turtle/bk` (no value)

An abbreviation for the `back` key.

`/tikz/turtle/left=<angle>` (default 90)

Turns the turtle left by the given angle.

`/tikz/turtle/lt` (no value)

An abbreviation for the `left` key.

`/tikz/turtle/right=<angle>` (default 90)

Turns the turtle right by the given angle.

`/tikz/turtle/rt` (no value)

An abbreviation for the `right` key.

Turtle graphics are especially nice in conjunction with the `\foreach` statement:



```
\tikz \filldraw [thick,blue,fill=blue!20]
[turtle=home]
\foreach \i in {1,...,5}
{
[turtle={forward,right=144}]
};
```

**Part V**

# **Data Visualization**

*by Till Tantau*

The documentation of the data visualization is still missing. This stuff is still “heavily under construction.”

## 52 Introduction to Data Visualization

*Data visualization* is the process of converting *data points*, which typically consist of multiple numerical values, into a graphical representation. Examples include the well-known function plots, but pie charts, bar diagrams, box plots, or vector fields are also examples of data visualizations.

The data visualization subsystem of PGF takes a general, open approach to data visualization. Like everything else in PGF, there is a powerful, but not-so-easy-to-use basic layer in the data visualization system and a less flexible, but much simpler-to-use frontend layer. The present section gives a quick overview of the basic ideas behind the data visualization system are introduced which are important for both layers.

### 52.1 Concept: Data Points

The most important input for a data visualization is always raw data. This data is typically present in different formats and the data visualization subsystem provides methods for reading such formats and also for defining new input formats. However, independently of the input format, we may ask what kind of data the data visualization subsystem should be able to process. For two-dimensional plots we need lists of pairs of real numbers. For a bar plot we usually need a list of numbers, possibly together with some colors and labels. For a surface plot we need a matrix of triples of real numbers. For a vector field we need even more complex data.

The data visualization subsystem makes no assumption whatsoever as to the kind of data that is being processed. Instead, the whole “rendering pipeline” is centered around a concept called the *data point*. Conceptually, a data point is an arbitrarily complex record that represents one piece of data that should be visualized. Data points are *not* just coordinates in the plane or the numerical values that need to be visualized. Rather, they represent the basic units of the data that needs to be visualized.

Consider the following example: In an experiment we drive a car along a road and have different measurement instruments installed. We measure the position of the car, the time, the speed, the direction the car is heading, the acceleration, and perhaps some further values. A data point would now consist of a record consisting of a timestamp together with the current position of the car (presumably two or three numbers), the speed vector (another two or three numbers), the acceleration (another two or three numbers), and perhaps the label text of the current experiment.

Data points should be “information rich.” They might even contain more information than what will actually be visualized. It is the job of the rendering pipeline to pick out the information relevant to one particular data visualization – another visualization of the same data might pick different aspects of the data points, thereby hopefully allowing new insights into the data.

Technically, there is no special data structure for data points. Rather, when a special macro called `\pgfdatapoint` is called, the “totality” of all currently set keys with the `/data point/` prefix in the current scope forms the data point. This is both a very general approach and quite fast since no extra data structures need to be created.

### 52.2 Concept: Visualization Pipeline

The *visualization pipeline* is a series of actions that are performed on the to-be-visualized data. As was just described, the data is presented to the visualization pipeline in the form of a long stream of quite complex data points. The visualization pipeline makes several passes over this stream of data points. During the first pass(es), called the *survey phase*, information is gathered about the data points such as minimal and maximal values, which can be useful for automatic fitting of the data into a given area. In the main pass over the data, called the *visualization phase*, the data points are actually visualized, for instance in the form of lines or points.

Like for data points, the visualized pipeline makes no assumptions as to what kind of visualization is desired. Indeed, one could even use it to produce a plain-text table. This flexibility is achieved by extensive use of objects and signals: When a data visualization starts, a number of signals (see Section 67.8 for an introduction to signals) are initialized. Then, numerous “visualization objects” are created that listen to these signals. These objects are all involved in processing the data points. For instance, the job of an `interval mapper` object is to map one attribute of a data point, such as a car’s velocity, to another, such as the *y*-axis of a plot. For each data point the different signals are raised in a certain order and the different visualization objects now have a chance of preparing the data point for the actual visualization. Continuing the above example, there might be a second `interval mapper` that takes the computed *y*-position and applies a logarithm to it, because a log-plot was requested. Then another mapper, this time a `polar mapper` might



be used to map everything to polar coordinates. Following this, a `plot mark visualizer` might actually draw something at the computed position.

The whole idea behind the rendering pipeline is that new kinds of data visualizations can be implemented, ideally, just by adding one or two new objects to the visualization pipeline. Furthermore, different kinds of plots can be combined in novel ways in this manner, which is usually very hard to do. For instance, the visualization pipeline makes it easy to create, say, polar-semilog-box-plots. At first sight, such new kinds of plots may seem superfluous, but data visualization is all about gaining insights into the data from as many different angles as possible.

Naturally, creating new classes and objects for the rendering pipeline is not trivial, so most users will just use the existing classes, which should, thus, be as flexible as possible. But even when one only intends to use existing classes, it is still tricky to setup the pipeline correctly since the ordering is obviously important and since tricky things like axes and ticks need to be configured and taken care of. For this reason, the frontend libraries provide preconfigured rendering pipelines so that one can simply say that a data visualization should look like a `school book plot` or a `scientific plot`, which selects a certain visualization pipeline appropriate for this kind of plot:

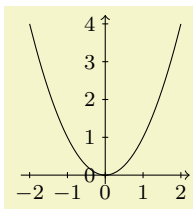

```
\begin{tikzpicture}[scale=.5]
\datavisualization [school book plot,smooth]
data [format=function] {
var x : interval [-2:2];
func y = \value x*\value x;
};
\end{tikzpicture}
```

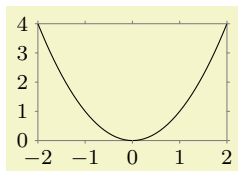

```
\begin{tikzpicture}[scale=.5]
\datavisualization [scientific plot,smooth]
data [format=function] {
var x : interval [-2:2];
func y = \value x*\value x;
};
\end{tikzpicture}
```

One must still configure such a plot (choose styles and themes and also specify which attributes of a data point should be used), but on the whole the plot is quite simple to specify.

## 53 Creating a Data Visualization

### 53.1 Overview

### 53.2 Concepts

### 53.3 Usage (TikZ)

For every data visualization some data is needed. This data is provided to the `\datavisualization` command via the use of the `data` command, see Section 53 for an introduction. The `data` command can be used repeatedly in a single visualization and each time the to-be-read data may have a different format.

```
\datavisualization ... data[<options>](inline data) ... ;
```

### 53.4 Reference:

### 53.5 Advanced: Data Visualization Objects

## 54 Providing Data for a Data Visualization

### 54.1 Overview

The data visualization system needs a stream of data points as input. These data points can be directly generated by repeatedly calling the `\pgfdatapoint` command, but usually data is available in some special (text) format and one one would like to visualize this data. The present section explains how data in some specific format can be fed to the data visualization system.

This section starts with an explanation of the main concepts. Then, the standard formats are listed in the reference section. It is also possible to define new formats, but this an advanced concept which requires an understanding of some of the internals of the parsing mechanism, explained in Section 54.4, and the usage of a rather low-level command, explained in Section 54.5.

### 54.2 Concepts

For the purposes of this section, let call a *data format* some standarderized way of writing down a list of data points. A simple example of a data format is the CSV format (the acronym stands for *comma separated values*), where each line contains a data point, specified by values separated by commas. A different format is the *key-value format*, where data points are specified by lists of key-value pairs. A far more complex format is the PDB-format used by the protein database to describe molecules.

The data visualization system does not use any specific format. Instead, whenever data is read by the data visualization system, you must specify a format parser (or it is chosen automatically for you). It is the job of the parser to read (parse) the data lines and to turn them into data points, that is, to setup appropriate subkeys of `/data point/`.

To give a concrete example, suppose a file contains the following lines:

```
x, y, z
0, 0, 0
1, 1, 0
1, 1, 0.5
0, 1, 0.5
```

This file is in the CSV-format. This format can be read by the `table` parser (which is called thus, rather than “`csv`,” since it can also read files in which the columns are separated by, say, a semicolon or a space). The `table` format will then read the data and for each line of the data, except for the headline of course, it will produce one data point. For instance, for the last data point the key `/data point/x` will be set to 0, the key `/data point/y` will be set to 1, and the key `/data point/z` will be set to 0.5.

All parsers are basically line-oriented. This means that, normally, each line in the input data should contain one data point. This rule may not always apply, for instance empty lines are typically ignored and sometimes a data point may span several lines, but deviating from this “one data point per line” rule makes parsers harder to program.

### 54.3 Reference: Standard Formats

The following format is the default format, when no `format=...` is specified.

Format `table`

This format is used to parse data that is formatted in the following manner: Basically, each line consists of *values* that are separated by a *separator* like a comma or a space. The values are stored in different *attributes*, that is, subkeys of `/data point` like `/data point/x`. In order to decide which attribute is chosen for a give value, the headline is important. This is the first non-empty line of a table. It is formatted in the same way as normal data lines (value separated by the separator), but the meaning of the values is different: The first value in the headline is the name of the attribute where the first values in the following lines should go each time. Similaly, the second value in the headline is the name of the attribute for the second values in the following lines, and so on.

A simple example is the following:

```
angle, radius
0, 1
45, 2
90, 3
135, 4
```

The headline states that the values in the first column should be stored in the `angle` attribute (`/data point/angle` to be precise) and that the values in the second column should be stored in the `radius` attribute. There are four data points in this data set.

The format will tolerate too few or too many values in a line. If there are less values in a line than in the headline, the last attributes will simply be empty. If there are more values in a line than in the headline, the values are stored in attributes called `/data point/attribute <column number>`, where the first value of a line gets `<column number>` equal to 1 and so on.

The `table` format can be configured using the following options:

`/pgf/data/separator=<character>` (no default, initially `,`)

Use this key to change which character is used to separate values in the headline and in the data lines. To set the separator to a space, either set this key to an empty value or say `separator=\space`. Note that you must surround a comma by curly braces if you which to (re)set the separator character to a space.

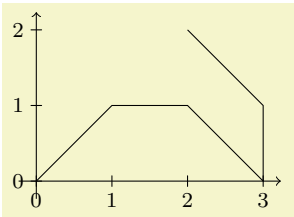

```
\begin{tikzpicture}
  \datavisualization [school book plot]
  data [separator=\space] {
    x y
    0 0
    1 1
    2 1
    3 0
  }
  data [separator=;] {
    x; y; z
    3; 1; 0
    2; 2; 0
  };
\end{tikzpicture}
```

`/pgf/data/headline=<headline>` (no default)

When this key is set to a non-empty value, the value of `<headline>` is used as the headline and the first line of the data is treated as a normal line rather than as a headline.

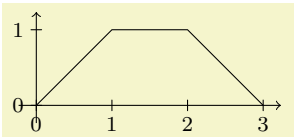

```
\begin{tikzpicture}
  \datavisualization [school book plot]
  data [headline={x, y}] {
    0, 0
    1, 1
    2, 1
    3, 0
  };
\end{tikzpicture}
```

### Format **key value pairs**

Each line of the data is simply passed to the `\pgfkeys` command with the path set to `/data point/`. This means that each data line will typically consist of comma-separated assignments of the form `<attribute>=<value>`.

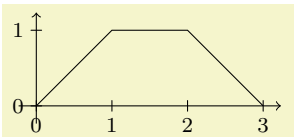

```
\begin{tikzpicture}
  \datavisualization [school book plot]
  data [format=key value pairs] {
    x=0, y=0
    x=1, y=1
    x=2, y=1
    x=3, y=0
  };
\end{tikzpicture}
```

Format **TeX code**

This format will simply execute each line of the data, each of which should contain some normal TeX code. Note that at the end of each line control returns to the format handler, so for instance the arguments of a command may not be spread over several lines. However, not each line needs to produce a data point.

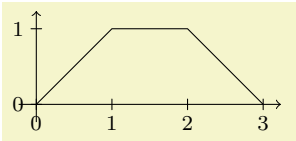

```
\begin{tikzpicture}
  \datavisualization [school book plot]
  data [format=TeX code] {
    \pgfkeys{/data point/.cd,x=0, y=0} \pgfdatapoint
    \pgfkeys{/data point/.cd,x=1, y=1} \pgfdatapoint
    \pgfkeys{/data point/x=2} \pgfdatapoint
    \pgfkeyssetvalue{/data point/x}{3}
    \pgfkeyssetvalue{/data point/y}{0} \pgfdatapoint
  };
\end{tikzpicture}
```

```
\usetikzlibrary{datavisualization.formats.functions} %  $\LaTeX$  and plain  $\TeX$ 
\usetikzlibrary[datavisualization.formats.functions] % Con $\TeX$ t
```

This library defines the formats described in the following, which allow you to specify the data points indirectly, namely via a to-be-evaluated function.

### Format **function**

This format allows you to specify a function that is then evaluated in order to create the desired data points. In other words, the data lines do not contain the data itself, but rather a functional description of the data.

The format used to specify the function works as follows: Each nonempty line of the data should contain at least one of either a *variable declaration* or a *function declaration*. A variable declaration signals that a certain attribute will range over a given interval. The function declarations will then, later, be evaluated for values inside this interval. The syntax for a variable declaration is as follows:

```
var  $\langle$ variable $\rangle$  : interval[ $\langle$ low $\rangle$ : $\langle$ high $\rangle$ ] samples  $\langle$ number $\rangle$  step  $\langle$ step $\rangle$ ;
```

The **samples** and **step** options cannot be given both at the same time. If both are missing, **samples** is used with the value stored in the following key:

```
/pgf/data/samples= $\langle$ number $\rangle$  (no default, initially 25)
```

Sets the number of samples to be used when no sample number is specified.

The meaning of a declaration like the above is the following: The attribute named  $\langle$ variable $\rangle$ , that is, the key `/data point/ $\langle$ variable $\rangle$` , will range over the interval [ $\langle$ low $\rangle$ ,  $\langle$ high $\rangle$ ]. If the number of **samples** is given (directly or indirectly), the interval is evenly divided into  $\langle$ number $\rangle$  many points and the attribute is set to each of these values. Similarly, when a  $\langle$ step $\rangle$  is specified, this stepping is used to increase  $\langle$ low $\rangle$  iteratively up to the largest value that is still less or equal to  $\langle$ high $\rangle$ .

You can specify more than one variable. In this case, each variable is varied independently of the other variables. For instance, if you declare an  $x$ -variable to range over the interval  $[0, 1]$  in 25 steps and you also declare a  $y$ -variable to range over the same interval, you get a total of 625 value pairs.

The variable declarations specify which (input) variables will take which values. It is the job of the *function declarations* to specify how some additional attributes are to be computed. The syntax of a function declaration is as follows:

```
func  $\langle$ attribute $\rangle$  =  $\langle$ expression $\rangle$ ;
```

The meaning of such a declaration is the following: For each setting of the input variables (the variables specified using the **var** declaration), evaluate the  $\langle$ expression $\rangle$  using the standard mathematical parser of TikZ. The resulting value is then stored in `/data point/ $\langle$ attribute $\rangle$` .

Inside  $\langle$ expression $\rangle$  you can reference data point attributes using the following command, which is only defined inside such an expression:

```
\value{ $\langle$ variable $\rangle$ }
```

This expands to the current value of the key `/data point/ $\langle$ variable $\rangle$` .

There can be multiple function declarations in a single data specification. In this case, all of these functions will be evaluated for each setting of input variables.

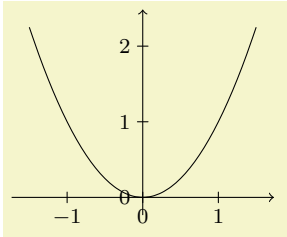

```
\begin{tikzpicture}
  \datavisualization [school book plot,smooth]
  data [format=function] {
    var x : interval [-1.5:1.5];

    func y = \value x * \value x;
  };
\end{tikzpicture}
```

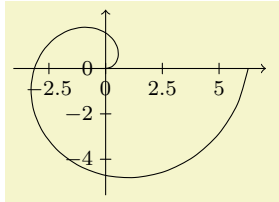

```
\begin{tikzpicture}
  \datavisualization [school book plot, smooth,
    all axes={ticks={few},unit length=3mm}]
  data [format=function] {
    var t : interval [0:2*pi];

    func x = \value t * cos(\value t r);
    func y = \value t * sin(\value t r);
  };
\end{tikzpicture}
```

## 54.4 Advanced: The Data Parsing Process

Whenever data is fed to the data visualization system, it will be handled by the `\pgfdata` command, declared in the `datavisualization` module. The command is both used to parse data stored in external sources (that is, in external files or which is produced on the fly by calling an external command) as well as data given inline. A data format does not need to know whether data comes from a file or is given inline, the `\pgfdata` command will take care of this.

Since  $\text{\TeX}$  will always read files in a line-wise fashion, data is always fed to data format parsers in such a fashion. Thus, even it would make more sense for a format to ignore line-breaks, the parser must still handle data given line-by-line.

Let us now have a look at how `\pgfdata` works.

`\pgfdata[options]{inline data}`

This command is used to feed data to the visualization pipeline. This command can only be used when a data visualization object has been properly setup, see Section 53.5.

**Basic options.** The `\pgfdata` command may be followed by *options*, which are executed with the path `/pgf/data/`. Depending on these options, the *options* may either be followed by *inline data* or, alternatively, no *inline data* is present and the data is read from an external source.

The first important option is *source*, which governs which of these two alternatives applies:

`/pgf/data/source=filename` (no default, initially empty)

If you set the `source` attribute to a non-empty *filename*, the data will be read from this file. In this case, no *inline data* may be present, not even empty curly braces should be provided. If `source` is empty, the data must directly follow as *inline data*.

```
% Data is read from two external files:
\pgfdata[format=table,source=file1.csv]
\pgfdata[format=table,source=file2.csv]
```

```
% Data is given inline:
\pgfdata[format=table]
{
  x, y
  1, 2
  2, 3
}
```

The second important key is `format`, which is used to specify the data format:

`/pgf/data/format=<format>` (no default, initially `table`)

Use this key to locally set the format used for parsing the data. The `<format>` must be a format that has been previously declared using the `\pgfdeclaredataformat` command. See the reference section for a list of the predefined formats.

In case all your data is in a certain format, you may wish to generally set the above key somewhere at the beginning of your file. Alternatively, you can use the following style to setup the `format` key and possibly further keys concerning the data format:

`/pgf/every data` (style, no value)

This style is executed by `\pgfdata` before the `<options>` are parsed.

Note that the path of this key is just `/pgf/`, not `/pgf/data/`. Also note that TikZ internally sets the value of this key up in such a way that the keys `/tikz/every data` and also `/tikz/data visualization/every data` are executed. The bottom line of this is that when using TikZ, you should not set this key directly, set `/tikz/every data` instead.

**Gathering of the data.** Once the data format and the source have been decided upon, the data is “gathered.” During this phase the data is not actually parsed in detail, but just gathered so that it can later be parsed during the visualization. There are two different ways in which the data is gathered:

- In case you have specified an external source, the data visualization object is told (by means of invoking the `add data` method) that it should (later) read data from the file specified by the `source` key using the format specified by the `format` key. The file is not read at this point, but only later during the actual visualization.
- Otherwise, namely when data is given inline, depending on which format is used, some catcodes get changed. This is necessary since T<sub>E</sub>X’s special characters are often not-so-special in a certain format.

Independently of the format, the end-of-line character (carriage return) is made an active character. Finally, the `<inline data>` is then read as a normal argument and the data visualization object is told that later on it should parse this data using the given format parser. Note that in this case the data visualization object must store the whole data internally.

In both cases the “data visualization object” is the object stored in the `/pgf/data visualization/obj` key.

**Parsing of the data.** During the actual data visualization, all code that has been added to the data visualization object by means of the `add data` method is executed several times. It is the job of this code to call the `\pgfdatapoint` method for all data points present in the data.

When the `\pgfdata` method calls `add data`, the code that is passed to the data visualization object is just a call to internal macros of `\pgfdata`, which are able to parse the data stored in an external file or in the inlined data. Independently of where the data is stored, these macros always do the following:

1. The catcodes are setup according to what the data format requires.
2. Format-specific startup code gets called, which can initialize internal variables of the parsing process. (The catcode changes are not part of the startup code since in order to read inline data `\pgfdata` must be able to setup to temporarily setup the catcodes needed later on by the parsers, but since no reading is to be done, no startup code should be called at this point.)
3. For each line of the data a format-specific code handler, which depends on the data format, is called. This handler gets the current line as input and should call `\pgfdatapoint` once for each data point that is encoded by this line (a line might define multiple data points or none at all). Empty lines are handled by special format-specific code.
4. At the end, format-specific end code is executed.

For an example of how this works, see the description of the `\pgfdeclaredataformat` command.

## 54.5 Advanced: Defining New Formats

In order to define a new data format you can use the following command, which is basic layer command defined in the module `datavisualization`:

`\pgfdeclaredataformat`{*format name*}{*catcode code*}{*startup code*}{*line arguments*}{*line code*}{*empty line code*}{*end code*}

This command defines a new data format called *format name*, which can subsequently be used in the `\pgfdata` command. (The TikZ's `data` maps directly to `\pgfdata`, so the following applies to TikZ as well.)

As explained in the description of the `\pgfdata` command, when data is being parsed that is formatted according to *format name*, the following happens:

1. The *catcode code* is executed. This code should just contain catcode changes. The *catcode code* will also be executed when inline data is read.
2. Next, the *startup code* is executed.
3. Next, for each non-empty line of the data, the line is passed to a macro whose argument list is given by *line arguments* and whose body is given by *line code*. The idea is that you can use T<sub>E</sub>X's powerful pattern matching capabilities to parse the non-empty lines. See also the below example.
4. Empty lines are not processed by the *line code*, but rather by the *empty line code*. Typically, empty lines can simply be ignored and in this case you can let this parameter be empty.
5. At the end of the data, the *end code* is executed.

As an example, let us now define a simple data format for reading files formatted in the following manner: Each line should contain a coordinate pair as in (1.2,3.2), so two numbers separated by a comma and surrounded by parentheses. To make things more interesting, suppose that the hash mark symbol can be used to indicate comments. Here is an example of some data given in this format:

```
# This is some data formatted according to the "coordinates" format
(0,0)
(0.5,0.25)
(1,1)
(1.5,2.25)
(2,4)
```

A format parser for this format could be defined as follows:

```
\pgfdeclaredataformat{coordinates}
% First comes the catcode argument. We turn the hash mark into a comment character.
{\catcode'\#=14\relax}
% Second comes the startup code. Since we do not need to setup things, we can leave
% it empty. Note that we could also set it to something like \begingroup, provided we
% put an \endgroup in the end code
{}
% Now comes the arguments for non-empty lines. Well, these should be of the form
% (#1,#2), so we specify that:
{(#1,#2)}
% Now we must do something with a line of this form. We store the #1 argument in
% /data point/x and #2 in /data point/y. Then we call \pgfdatapoint to create a data point.
{
  \pgfkeyssetvalue{/data point/x}{#1}
  \pgfkeyssetvalue{/data point/y}{#2}
  \pgfdatapoint
}
% We ignore empty lines:
{}
% And we also have no end-of-line code.
{}
```

This format could now be used as follows:



```
\begin{tikzpicture}
  \datavisualization[school book plot,smooth]
  data [format=coordinates] {
    # This is some data formatted according
    # to the "coordinates" format
    (0,0)
    (0.5,0.25)
    (1,1)
    (1.5,2.25)
    (2,4)
  };
\end{tikzpicture}
```

A first example:

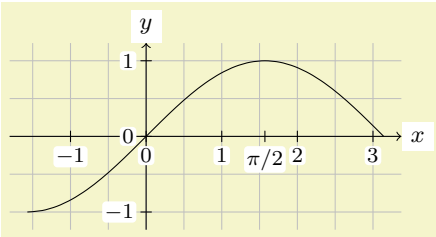

```
\begin{tikzpicture}[baseline]
  \datavisualization [
    school book plot,
    smooth,
    clean ticks,
    all axes={grid={step=1,minor steps between steps=1}},
    x axis={
      ticks={some,
        major={also at={0.5*pi as $\pi/2$}}
      },
      label=$x$
    },
    y axis={
      label=$y$,
    }
  ]
  data [format=function] {
    var x : interval [-0.5*pi:pi];
    func y = sin(\value x r);
  };
\end{tikzpicture}
```

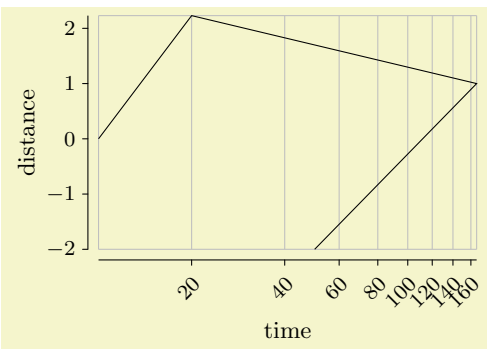

```
\begin{tikzpicture}[baseline]
  \datavisualization [
    scientific clear axes,
    line plot,
    all axes={padding=4pt},
    x axis={log axis,
      ticks={many,
        node style={rotate=45,anchor=north east}},
      label={time},
      grid=many},
    y axis={ticks={some},label={distance}},
  ]
  data {
    x, y, z
    10, 0, 0
    20, 2.23, 2
    167, 1, 3
    50, -2, 0
  };
\end{tikzpicture}
```

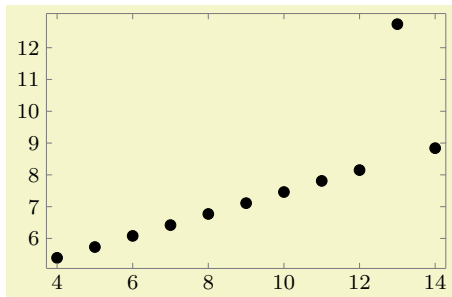

```

\begin{tikzpicture}[baseline,mark=*]
  \datavisualization [
    scientific inner axes,
    all axes={padding=4pt},
    euro about strategy,
    scatter plot,
    x axis={attribute=x2},
    y axis={attribute=y2}
  ]
  data [separator=\space] {
x      y      x1     y1     x2     y2     x3     y3
10.0   8.04   10.0   9.14   10.0   7.46   8.0    6.58
8.0    6.95    8.0    8.14   8.0    6.77   8.0    5.76
13.0   7.58    13.0   8.74   13.0   12.74  8.0    7.71
9.0    8.81    9.0    8.77   9.0    7.11   8.0    8.84
11.0   8.33    11.0   9.26   11.0   7.81   8.0    8.47
14.0   9.96    14.0   8.10   14.0   8.84   8.0    7.04
6.0    7.24    6.0    6.13   6.0    6.08   8.0    5.25
4.0    4.26    4.0    3.10   4.0    5.39   19.0   12.50
12.0   10.84   12.0   9.13   12.0   8.15   8.0    5.56
7.0    4.82    7.0    7.26   7.0    6.42   8.0    7.91
5.0    5.68    5.0    4.74   5.0    5.73   8.0    6.89
  };
\end{tikzpicture}

```

# Part VI

## Utilities

by Till Tantau

The utility packages are not directly involved in creating graphics, but you may find them useful nonetheless. All of them either directly depend on PGF or they are designed to work well together with PGF even though they can be used in a stand-alone way.

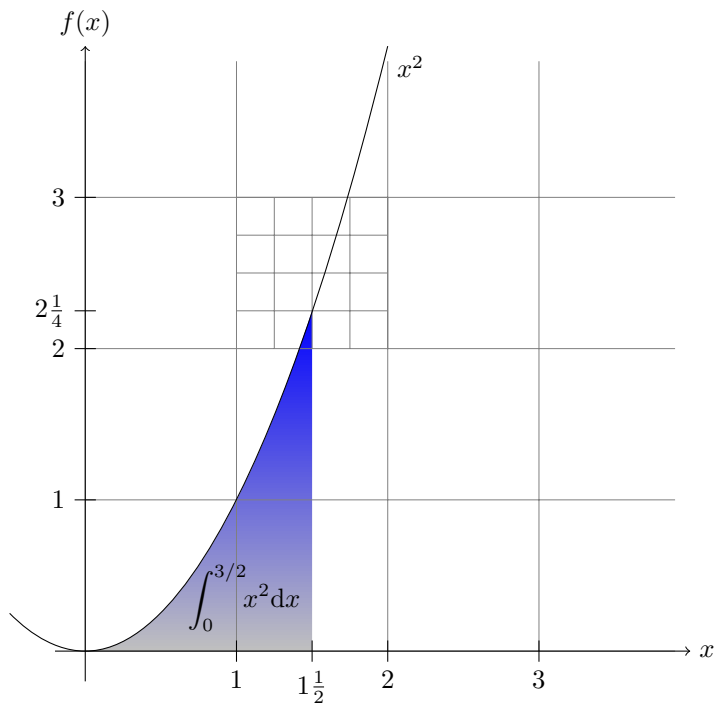

```
\begin{tikzpicture}[scale=2]
  \shade[top color=blue,bottom color=gray!50] (0,0) parabola (1.5,2.25) |- (0,0);
  \draw (1.05cm,2pt) node[above] {\displaystyle\int_0^{3/2} \! \! \! x^2 \mathrm{d}x};

  \draw[help lines] (0,0) grid (3.9,3.9)
    [step=0.25cm] (1,2) grid +(1,1);

  \draw[->] (-0.2,0) -- (4,0) node[right] {$x$};
  \draw[->] (0,-0.2) -- (0,4) node[above] {$f(x)$};

  \foreach \x/\xtext in {1/1, 1.5/1\frac{1}{2}, 2/2, 3/3}
    \draw[shift={(\x,0)}] (0pt,2pt) -- (0pt,-2pt) node[below] {\xtext};

  \foreach \y/\ytext in {1/1, 2/2, 2.25/2\frac{1}{4}, 3/3}
    \draw[shift={(0,\y)}] (2pt,0pt) -- (-2pt,0pt) node[left] {\ytext};

  \draw (-.5,.25) parabola bend (0,0) (2,4) node[below right] {$x^2$};
\end{tikzpicture}
```

## 55 Key Management

This section describes the package `pgfkeys`. It is loaded automatically by both PGF and TikZ.

```
\usepackage{pgfkeys} %  $\TeX$ 
\input pgfkeys.tex % plain  $\TeX$ 
\usemodule[pgfkeys] % Con $\TeX$ t
```

This package can be used independently of PGF. Note that no other package of PGF needs to be loaded (so neither the emulation layer nor the system layer is needed). The Con $\TeX$ t abbreviation is `pgfkey` if `pgfmod` is not loaded.

### 55.1 Introduction

#### 55.1.1 Comparison to Other Packages

The `pgfkeys` package defines a key–value management system that is in some sense similar to the more light-weight `keyval` system and the improved `xkeyval` system. However, `pgfkeys` uses a slightly different philosophy than these systems and it will coexist peacefully with both of them.

The main differences between `pgfkeys` and `xkeyval` are the following:

- `pgfkeys` organizes keys in a tree, while `keyval` and `xkeyval` use families. In `pgfkeys` the families correspond to the root entries of the key tree.
- `pgfkeys` has no save-stack impact (you will have to read the  $\TeX$ Book very carefully to appreciate this).
- `pgfkeys` is slightly slower than `keyval`, but not much.
- `pgfkeys` supports styles. This means that keys can just stand for other keys (which can stand for other keys in turn or which can also just execute some code). TikZ uses this mechanism heavily.
- `pgfkeys` supports multi-argument key code. This can, however, be emulated in `keyval`.
- `pgfkeys` supports handlers. These are call-backs that are called when a key is not known. They are very flexible, in fact even defining keys in different ways is handled by, well, handlers.

#### 55.1.2 Quick Guide to Using the Key Mechanism

The following quick guide to PGF’s key mechanism only treats the most commonly used features. For an in-depth discussion of what is going on, please consult the remainder of this section.

Keys are organized in a large tree that is reminiscent of the Unix file tree. A typical key might be, say, `/tikz/coordinate system/x` or just `/x`. Again as in Unix, when you specify keys you can provide the complete path of the key, but you usually just provide the name of the key (corresponding to the file name without any path) and the path is added automatically.

Typically (but not necessarily) some code is associated with a key. To execute this code, you use the `\pgfkeys` command. This command takes a list of so-called key–value pairs. Each pair is of the form `\pgfkeys{<key>=<value>}`. For each pair the `\pgfkeys` command will execute the code stored for the `<key>` with its parameter set to `<value>`.

Here is a typical example of how the `\pgfkeys` command is used:

```
\pgfkeys{/my key=hallo,/your keys/main key=something\strange,
key name without path=something else}
```

Now, to set the code that is stored in a key you do not need to learn a new command. Rather, the `\pgfkeys` command can also be used to set the code of a key. This is done using so-called *handlers*. They look like keys whose names look like “hidden files in Unix” since they start with a dot. The handler for setting the code of a key is appropriately called `.code` and it is used as follows:

```
The value is 'hi!'. \pgfkeys{/my key/.code=The value is '#1'.}
\pgfkeys{/my key=hi!}
```

As you can see, in the first line we defined the code for the key `/my key`. In the second line we executed this code with the parameter set to `hi!`.

There are numerous handlers for defining a key. For instance, we can also define a key whose value actually consists of more than one parameter.

The values are 'a1' and 'a2'.

```
\pgfkeys{/my key/.code 2 args=The values are '#1' and '#2'.}
\pgfkeys{/my key={a1}{a2}}
```

We often want to have keys where the code is called with some default value if the user does not provide a value. Not surprisingly, this is also done using a handler, this time called `.default`.

```
(hallo)(hello) \pgfkeys{/my key/.code=(#1)}
                \pgfkeys{/my key/.default=hello}
                \pgfkeys{/my key=hallo,/my key}
```

The other way round, it is also possible to specify that a value *must* be specified, using a handler called `.value required`. Finally, you can also require that no value *may* be specified using `.value forbidden`.

All keys for a package like, say, TikZ start with the path `/tikz`. We obviously do not like to write this path down every time we use a key (so we do not have to write things like `\draw[/tikz/line width=1cm]`). What we need is to somehow “change the default path to a specific location.” This is done using the handler `.cd` (for “change directory”). Once this handler has been used on a key, all subsequent keys *in the current call of `\pgfkeys` only* are automatically prefixed with this path, if necessary.

Here is an example:

```
\pgfkeys{/tikz/.cd,line width=1cm,line cap=round}
```

This makes it easy to define commands like `\tikzset`, which could be defined as follows (the actual definition is a bit faster, but the effect is the same):

```
\def\tikzset#1{\pgfkeys{/tikz/.cd,#1}}
```

When a key is handled, instead of executing some code, the key can also cause further keys to be executed. Such keys will be called *styles*. A style is, in essence, just a key list that should be executed whenever the style is executed. Here is an example:

```
(a:foo)(b:bar)(a:wow) \pgfkeys{/a/.code=(a:#1)}
                       \pgfkeys{/b/.code=(b:#1)}
                       \pgfkeys{/my style/.style={/a=foo,/b=bar,/a=#1}}
                       \pgfkeys{/my style=wow}
```

As the above example shows, style can also be parametrized, just like the normal code keys.

As a typical use of styles, suppose we wish to setup the key `/tikz` so that it will change the default path to `/tikz`. This can be achieved as follows:

```
\pgfkeys{/tikz/.style=/tikz/.cd}
\pgfkeys{tikz,line width=1cm,draw=red}
```

Note that when `\pgfkeys` is executed, the default path is set to `/`. This means that the first `tikz` will be completed to `/tikz`. Then `/tikz` is a style and, thus, replaced by `/tikz/.cd`, which changes the default path to `/tikz`. Thus, the `line width` is correctly prefixed with `/tikz`.

## 55.2 The Key Tree

The `pgfkeys` package organizes keys in a so-called *key tree*. This tree will be familiar to anyone who has used a Unix operating system: A key is addressed by a path, which consists of different parts separated by slashes. A typical key might be `/tikz/line width` or just `/tikz` or something more complicated like `/tikz/cs/x/.store in`.

Let us fix some further terminology: Given a key like `/a/b/c`, we call the part leading up the last slash (`/a/b`) the *path* of the key. We call everything after the last slash (`c`) the *name* of the key (in a file system this would be the file name).

We do not always wish to specify keys completely. Instead, we usually specify only part of a key (typically only the name) and the *default path* is then added to the key at the front. So, when the default path is `/tikz` and you refer to the (partial) key `line width`, the actual key that is used is `/tikz/line width`. There is a simple rule for deciding whether a key is a partial key or a full key: If it starts with a slash, then it is a full key and it is not modified; if it does not start with a slash, then the default path is automatically prefixed.

Note that the default path is not the same as a search path. In particular, the default path is just a single path. When a partial key is given, only this single default path is prefixed; `pgfkeys` does not try to

lookup the key in different parts of a search path. It is, however, possible to emulate search paths, but a much more complicated mechanism must be used.

When you set keys (to be explained in a moment), you can freely mix partial and full keys and you can change the default path. This makes it possible to temporarily use keys from another part of the key tree (this turns out to be a very useful feature).

Each key (may) store some *tokens* and there exist commands, described below, for setting, getting, and changing the tokens stored in a key. However, you will only very seldom use these commands directly. Rather, the standard way of using keys is the `\pgfkeys` command or some command that uses it internally like, say, `\tikzset`. So, you may wish to skip the following commands and continue with the next subsection.

**`\pgfkeyssetvalue`**`{⟨full key⟩}{⟨token text⟩}`

Stores the `⟨token text⟩` in the `⟨full key⟩`. The `⟨full key⟩` may not be a partial key, so no default-path-adding is done. The `⟨token text⟩` can be arbitrary tokens and may even contain things like `#` or unbalanced `TEX`-ifs.

|               |                                                                                                                    |
|---------------|--------------------------------------------------------------------------------------------------------------------|
| Hello, world! | <code>\pgfkeyssetvalue{/my family/my key}{Hello, world!}</code><br><code>\pgfkeysvalueof{/my family/my key}</code> |
|---------------|--------------------------------------------------------------------------------------------------------------------|

The setting of a key is always local to the current `TEX` group.

**`\pgfkeyslet`**`{⟨full key⟩}{⟨macro⟩}`

Performs a `\let` statement so the the `⟨full key⟩` points to the contents of `⟨macro⟩`.

|               |                                                                                                                                                            |
|---------------|------------------------------------------------------------------------------------------------------------------------------------------------------------|
| Hello, world! | <code>\def\helloworld{Hello, world!}</code><br><code>\pgfkeyslet{/my family/my key}{\helloworld}</code><br><code>\pgfkeysvalueof{/my family/my key}</code> |
|---------------|------------------------------------------------------------------------------------------------------------------------------------------------------------|

You should never let a key be equal to `\relax`. Such a key may or may not be indistinguishable from an undefined key.

**`\pgfkeysgetvalue`**`{⟨full key⟩}{⟨macro⟩}`

Retrieves the tokens stored in the `⟨full key⟩` and lets `⟨macro⟩` be equal to these tokens. If the key has not been set, the `⟨macro⟩` will be equal to `\relax`.

|               |                                                                                                                                                              |
|---------------|--------------------------------------------------------------------------------------------------------------------------------------------------------------|
| Hello, world! | <code>\pgfkeyssetvalue{/my family/my key}{Hello, world!}</code><br><code>\pgfkeysgetvalue{/my family/my key}{\helloworld}</code><br><code>\helloworld</code> |
|---------------|--------------------------------------------------------------------------------------------------------------------------------------------------------------|

**`\pgfkeysvalueof`**`{⟨full key⟩}`

Inserts the value stored in `⟨full key⟩` at the current position into the text.

|               |                                                                                                                    |
|---------------|--------------------------------------------------------------------------------------------------------------------|
| Hello, world! | <code>\pgfkeyssetvalue{/my family/my key}{Hello, world!}</code><br><code>\pgfkeysvalueof{/my family/my key}</code> |
|---------------|--------------------------------------------------------------------------------------------------------------------|

**`\pgfkeysifdefined`**`{⟨full key⟩}{⟨if⟩}{⟨else⟩}`

Checks whether this key was previously set using either `\pgfkeyssetvalue` or `\pgfkeyslet`. If so, the code in `⟨if⟩` is executed, otherwise the code in `⟨else⟩`.

This command will use `eTEX`'s `\ifcsname` command, if available, for efficiency. This means, however, that it may behave differently for `TEX` and for `eTEX` when you set keys to `\relax`. For this reason you should not do so.

|     |                                                                                                                               |
|-----|-------------------------------------------------------------------------------------------------------------------------------|
| yes | <code>\pgfkeyssetvalue{/my family/my key}{Hello, world!}</code><br><code>\pgfkeysifdefined{/my family/my key}{yes}{no}</code> |
|-----|-------------------------------------------------------------------------------------------------------------------------------|

### 55.3 Setting Keys

Settings keys is done using a powerful command called `\pgfkeys`. This command takes a list of so-called *key-value pairs*. These are pairs of the form `⟨key⟩=⟨value⟩`. The principle idea is the following: For each pair in the list, some *action* is taken. This action can be one of the following:

1. A command is executed whose argument(s) are  $\langle value \rangle$ . This command is stored in a special subkey of  $\langle key \rangle$ .
2. The  $\langle value \rangle$  is stored in the  $\langle key \rangle$  itself.
3. If the key's name (the part after the last slashes) is a known *handler*, then this handler will take care of the key.
4. If the key is totally unknown, one of several possible *unknown key handlers* is called.

Additionally, if the  $\langle value \rangle$  is missing, a default value may or may not be substituted. Before we plunge into all the details, let us have a quick look at the command itself.

**`\pgfkeys{ $\langle key list \rangle$ }`**

The  $\langle key list \rangle$  should be a list of key–value pairs, separated by commas. A key–value pair can have the following two forms:  $\langle key \rangle = \langle value \rangle$  or just  $\langle key \rangle$ . Any spaces around the  $\langle key \rangle$  or around the  $\langle value \rangle$  are removed. It is permissible to surround both the  $\langle key \rangle$  or the  $\langle value \rangle$  in curly braces, which are also removed. Especially putting the  $\langle value \rangle$  in curly braces needs to be done quite often, namely whenever the  $\langle value \rangle$  contains an equal-sign or a comma.

The key–value pairs in the list are handled in the order they appear. How this handling is done, exactly, is described in the rest of this section.

If a  $\langle key \rangle$  is a partial key, the current value of the default path is prefixed to the  $\langle key \rangle$  and this “upgraded” key is then used. The default path is just the root path / when the first key is handled, but it may change later on. At the end of the command, the default path is reset to the value it had before this command was executed.

Calls of this command may be nested. Thus, it is permissible to call `\pgfkeys` inside the code that is executed for a key. Since the default path is restored after a call of `\pgfkeys`, the default path will not change when you call `\pgfkeys` while executing code for a key (which is exactly what you want).

**`\pgfqkeys{ $\langle default path \rangle$ }{ $\langle key list \rangle$ }`**

This command has the same effect as `\pgfkeys{ $\langle default path \rangle$ /.cd, $\langle key list \rangle$ }`, it is only marginally quicker. This command should not be used in user code, but rather in commands like `\tikzset` or `\pgfset` that get called very often.

**`\pgfkeysalso{ $\langle key list \rangle$ }`**

This command has exactly the same effect as `\pgfkeys`, only the default path is not modified before or after the keys are being set. This command is mainly intended to be called by the code that is being processed for a key.

**`\pgfqkeysalso{ $\langle default path \rangle$ }{ $\langle key list \rangle$ }`**

This command has the same effect as `\pgfkeysalso{ $\langle default path \rangle$ /.cd, $\langle key list \rangle$ }`, it is only quicker. Changing the default path inside a `\pgfkeyalso` is dangerous, so use with care. A rather safe place to call this command is at the beginning of a  $\text{\TeX}$  group.

### 55.3.1 Default Arguments

The arguments of the `\pgfkeys` command can either be of the form  $\langle key \rangle = \langle value \rangle$  or of the form  $\langle key \rangle$  with the value-part missing. In the second case, the `\pgfkeys` will try to provide a *default value* for the  $\langle value \rangle$ . If such a default value is defined, it will be used as if you had written  $\langle key \rangle = \langle default value \rangle$ .

In the following, the details of how default values are determined is described; however, you should normally use the handlers `.default` and `.value required` as described in Section 55.4.2 and you can may wish to skip the following details.

When `\pgfkeys` encounters a  $\langle key \rangle$  without an equal-sign, the following happens:

1. The input is replaced by  $\langle key \rangle = \text{\pgfkeysnovalue}$ . In particular, the commands `\pgfkeys{my key}` and `\pgfkeys{my key=\text{\pgfkeysnovalue}}` have exactly the same effect and you can “simulate” a missing value by providing the value `\text{\pgfkeysnovalue}`, which is sometimes useful.
2. If the  $\langle value \rangle$  is `\text{\pgfkeysnovalue}`, then it is checked whether the subkey  $\langle key \rangle / .\text{\@def}$  exists. For instance, if you write `\pgfkeys{/my key}`, then it is checked whether the key `/my key/.\text{\@def}` exists.



3. If the key  $\langle key \rangle/.@def$  exists, then the tokens stored in this key are used as  $\langle value \rangle$ .
4. If the key does not exist, then `\pgfkeysnovalue` is used as the  $\langle value \rangle$ .
5. At the end, if the  $\langle value \rangle$  is now equal to `\pgfkeysvaluerequired`, then the code (or something fairly equivalent) `\pgfkeys{/errors/value required=\langle key \rangle{}}` is executed. Thus, by changing this key you can change the error message that is printed or you can handle the missing value in some other way.

### 55.3.2 Keys That Execute Commands

After the transformation process described in the previous subsection, we arrive at a key of the form  $\langle key \rangle = \langle value \rangle$ , where  $\langle key \rangle$  is a full key. Different things can now happen, but always the macro `\pgfkeyscurrentkey` will have been setup to expand to the text of the  $\langle key \rangle$  that is currently being processed.

The first things that is tested is whether the key  $\langle key \rangle/.@cmd$  exists. If this is the case, then it is assumed that this key stores the code of a macro and this macro is executed. The argument of this macro is  $\langle value \rangle$  directly followed by `\pgfeov`, which stands for “end of value.” The  $\langle value \rangle$  is not surrounded by braces. After this code has been executed, `\pgfkeys` continues with the next key in the  $\langle key list \rangle$ .

It may seem quite peculiar that the macro stored in the key  $\langle key \rangle/.@cmd$  is not simply executed with the argument  $\{\langle value \rangle\}$ . However, the approach taken in the `pgfkeys` packages allows for more flexibility. For instance, assume that you have a key that expects a  $\langle value \rangle$  of the form “ $\langle text \rangle + \langle more text \rangle$ ” and wishes to store  $\langle text \rangle$  and  $\langle more text \rangle$  in two different macros. This can be achieved as follows:

|                                        |                                                                                                                                                         |
|----------------------------------------|---------------------------------------------------------------------------------------------------------------------------------------------------------|
| <code>\a is hello, \b is world.</code> | <pre> \def\mystore#1+#2\pgfeov{\def\a{#1}\def\b{#2}} \pgfkeyslet{/my key/.@cmd}{\mystore} \pgfkeys{/my key=hello+world}   \a  is \a,  \b  is \b. </pre> |
|----------------------------------------|---------------------------------------------------------------------------------------------------------------------------------------------------------|

Naturally, defining the code to be stored in a key in the above manner is too awkward. The following commands simplify things a bit, but the usual manner of setting up code for a key is to use one of the handlers described in Section 55.4.3.

**`\pgfkeysdef`** $\{\langle key \rangle\}\{\langle code \rangle\}$

This command temporarily defines a TeX-macro with the argument list `#1\pgfeov` and then lets  $\langle key \rangle/.@cmd$  be equal to this macro. The net effect of all this is that you have then setup code for the key  $\langle key \rangle$  so that when you write `\pgfkeys{\langle key \rangle = \langle value \rangle}`, then the  $\langle code \rangle$  is executed with all occurrences of `#1` in  $\langle code \rangle$  being replaced by  $\langle value \rangle$ . (This behaviour is quite similar to the `\define@key` command of `keyval` and `xkeyval`).

|                            |                                                                    |
|----------------------------|--------------------------------------------------------------------|
| <code>hello, hello.</code> | <pre> \pgfkeysdef{/my key}{#1, #1.} \pgfkeys{/my key=hello} </pre> |
|----------------------------|--------------------------------------------------------------------|

**`\pgfkeysedef`** $\{\langle key \rangle\}\{\langle code \rangle\}$

This command works like `\pgfkeysdef`, but it uses `\edef` rather than `\def` when defining the key macro. If you do not know the difference between the two, then you will not need this command; and if you know the difference, then you will know when you need this command.

**`\pgfkeysdefargs`** $\{\langle key \rangle\}\{\langle argument pattern \rangle\}\{\langle code \rangle\}$

This command works like `\pgfkeysdef`, but it allows you to provide an arbitrary  $\langle argument pattern \rangle$  rather than just the simple single argument of `\pgfkeysdef`.

|                                        |                                                                                                                           |
|----------------------------------------|---------------------------------------------------------------------------------------------------------------------------|
| <code>\a is hello, \b is world.</code> | <pre> \pgfkeysdefargs{/my key}{#1+#2}{\def\a{#1}\def\b{#2}} \pgfkeys{/my key=hello+world}   \a  is \a,  \b  is \b. </pre> |
|----------------------------------------|---------------------------------------------------------------------------------------------------------------------------|

**`\pgfkeysedefargs`** $\{\langle key \rangle\}\{\langle argument pattern \rangle\}\{\langle code \rangle\}$

The `\edef` version of `\pgfkeysdefargs`.

### 55.3.3 Keys That Store Values

Let us continue with what happens when `\pgfkeys` processes the current key and the subkey  $\langle key \rangle/.@cmd$  is not defined. Then it is checked whether the  $\langle key \rangle$  itself exists (has been previously assigned a value using, for instance, `\pgfkeyssetvalue`). In this case, the tokens stored in  $\langle key \rangle$  are replaced by  $\langle value \rangle$  and `\pgfkeys` proceeds with the next key in the  $\langle key list \rangle$ .

### 55.3.4 Keys That Are Handled

If neither the  $\langle key \rangle$  itself nor the subkey  $\langle key \rangle/.@cmd$  are defined, then the  $\langle key \rangle$  cannot be processed “all by itself.” Rather, a  $\langle handler \rangle$  is needed for this key. Most of the power of `pgfkeys` comes from the proper use of such handlers.

Recall that the  $\langle key \rangle$  is always a full key (if it was not originally, it has already been upgraded at this point to a full key). It decomposed into two parts:

1. The  $\langle path \rangle$  of  $\langle key \rangle$  (everything before the last slash) is stored in the macro `\pgfkeyscurrentpath`.
2. The  $\langle name \rangle$  of  $\langle key \rangle$  (everything after the last slash) is stored in the macro `\pgfkeyscurrentname`.

It is recommended (but not necessary) that the name of a handler starts with a dot (but not with `.@`), so that they are easy to detect for the reader.

(For efficiency reasons, these two macros are only setup at this point; so when code is executed for a key in the “usual” manner then these macros are not setup.)

The `\pgfkeys` command now checks whether the key `/handlers/ $\langle name \rangle/.@cmd$`  exists. If so, it should store a command and this command is executed exactly in the same manner as described in Section 55.3.2. Thus, this code gets the  $\langle value \rangle$  that was originally intended for  $\langle key \rangle$  as its argument, followed by `\pgfeov`. It is the job of the handlers to do something useful with the  $\langle value \rangle$ .

For an example, let us write a handler that will output the value stored in a key to the log file. We call this handler `.print to log`. The idea is that when someone tries to use the key `/my key/.print to log`, then this key will not be defined and the handler gets executed. The handler will then have access to the path-part of the key, which is `/my key`, via the macro `\pgfkeyscurrentpath`. It can then lookup which value is stored in this key and print it.

```
\pgfkeysdef{/handlers/.print to log}
{%
  \pgfkeysgetvalue{\pgfkeyscurrentpath}{\temp}
  \writetolog{\temp}
}
\pgfkeyssetvalue{/my key}{Hi!}
...
\pgfkeys{/my key/.print to log}
```

The above code will print `Hi!` in the log, provided the macro `\writetolog` is setup appropriately.

For a more interesting handler, let us program a handler that will setup a key so that when the key is used some code is executed. This code is given as  $\langle value \rangle$ . All the handler must do is to call `\pgfkeysdef` for the path of the key (which misses the handler’s name) and assign the parameter value to it.

```
(hallo) \pgfkeysdef{/handlers/.my code}{\pgfkeysdef{\pgfkeyscurrentpath}{#1}}
\pgfkeys{/my key/.my code=#1}
\pgfkeys{/my key=hallo}
```

There are some parameters for handled keys which prove to be useful in some (possibly rare) special cases:

`/handler config=all|only existing|full or existing` (no default, initially all)

Changes the initial configuration how key handlers will be used.

**all** The preconfigured setting **all** works as described above and imposes no restriction on the key setting process.

**only existing** The value **only existing** modifies the algorithm for handled keys as follows: a handler  $\langle key name \rangle/. \langle handler \rangle$  will be executed only if  $\langle key name \rangle$  is either a key which stores its value directly or a command key for which `/.@cmd` exists. If  $\langle key name \rangle$  does *not* exist already, the complete string  $\langle key name \rangle/. \langle handler \rangle$  is considered to be an unknown key and the procedure described in the next section applies (for the path of  $\langle key name \rangle$ ).

Initial definition.Re-Definition.Unknown key ‘.

```
% Define a test key and error handlers:
\pgfkeys{/the/key/.code={Initial definition. }}
\pgfkeys{/handlers/.unknown/.code={Unknown key ‘\pgfkeyscurrentkey’. }}

% calling the test key yields ‘Initial definition. ’:
\pgfkeys{/the/key}

% Change configuration:
\pgfkeys{/handler config=only existing}

% allowed: key *re*-definition:
\pgfkeys{/the/key/.code={Re-Definition. }}
% calling the key yields ‘Re-Definition. ’:
\pgfkeys{/the/key}

% not allowed: definition of new keys:
% this checks for ‘/the/other key/.unknown’
% and ‘/handlers/.unknown’
% and yields finally
% ‘Unknown key ‘/the/other key/.code’
\pgfkeys{/the/other key/.code={New definition. }}
```

It is necessary to exclude some key handlers from this procedure. Altogether, the detailed procedure is as follows:

1. If a handled key like `/a path/a key/.a handler=value` is encountered, it is checked whether the handler should be invoked. This is the case if
  - An exception from `only existing` for this key exists (see below),
  - The key `/a path/a key` exists already – either directly as storage key or with the `.@cmd` suffix.
2. If the check passes, everything works as before.
3. If the check fails, the complete key will be considered to be unknown. In that case, the handling of unknown keys as described in the next section applies. There, the current key path will be set to `/a path` and the current key’s name to `key/.a handler`.

A consequence of this configuration is to provide more meaningful processing of handled keys if a search path for keys is in effect, see section 55.3.5 for an example.

`full or existing` Finally, the choice `full or existing` is a variant of `only existing`: it works in the same way for keys which do not have a full key path. For example, the style

```
\pgfkeys{/my path/.cd,key/.style={...}}
```

can only be redefined: it doesn’t have a full path, so the `only existing` mechanism applies. But the style

```
\pgfkeys{/my path/key/.style={...}}
```

will still work. This allows users to override the `only existing` feature if they know what they’re doing (and provide full key paths).

`/handler config/only existing/add exception={⟨key handler name⟩}` (no default)

Allows to add exceptions to the `/handler config=only existing` feature. Initially exceptions for the key handlers `.cd`, `.try`, `.retry`, `.lastretry` and `.unknown` are defined. The value `{⟨key handler name⟩}` should be the name of a key handler.

`\pgfkeyssetdefaultpathforhandled{⟨key path prefix⟩}`

Changes the initial configuration how key handlers will be used: it sets a separate default path which applies only to handled keys.

The effect is: if a handled key was not fully qualified, its key path will be set to `⟨key path prefix⟩/`.

```
(The code) \pgfkeyssetdefaultpathforhandled{/another/path}
\pgfkeys{/path/to/key}{a style/.code={⟨The code⟩}}
\pgfkeys{/another/path/a style}
```

Since `/path/to/key` is the default key path, the standard behavior of `pgfkeys` would be to modify `/path/to/key/a style`, but the explicitly changed default path leads to the modification of `/another/path/a style` instead.

However, the case

```
(The code) \pgfkeyssetdefaultpathforhandled{/another/path}
\pgfqkeys{/path/to/key}{/path/to/key/a style/.code={The code}}
\pgfkeys{/path/to/key/a style}
```

shows that fully qualified handled keys won't be affected by the changed default path.

The Motivation for such changes is to provide well-defined handled keys if multiple search paths are in effect, see section 55.3.5 for an example.

Please note that `handler config` and `\pgfkeyssetdefaultpathforhandled` can't be combined.

### 55.3.5 Keys That Are Unknown

For some keys, neither the key is defined nor its `.@cmd` subkey nor is a handler defined for this key. In this case, it is checked whether the key `<current path>/.unknown/.@cmd` exists. Thus, when you try to use the key `/tikz/strange`, then it is checked whether `/tikz/.unknown/.@cmd` exists. If this key exists (which it does), it is executed. This code can then try to make sense of the key. For instance, the handler for `TikZ` will try to interpret the key's name as a color or as an arrow specification or as a PGF option.

You can setup unknown key handlers for your own keys by simply setting the code of the key `<my path prefix>/.unknown`. This also allows you to setup "search paths." The idea is that you would like keys to be searched not only in a single default path, but in several. Suppose, for instance, that you would like keys to be searched for in `/a`, `/b`, and `/b/c`. We setup a key `/my search path` for this:

```
\pgfkeys{/my search path/.unknown/.code=
  {%
  \let\searchname=\pgfkeyscurrentname%
  \pgfkeysalso{%
    /a/\searchname/.try=#1,
    /b/\searchname/.retry=#1,
    /b/c/\searchname/.retry=#1%
  }%
  }%
}
```

In the above code, `foo` and `bar` will be searched for in the three directories `/a`, `/b`, and `/b/c`. Before you start implementing search paths using this pattern, consider the `.search also` handler discussed below.

If the key `<current path>/.unknown/.@cmd` does not exist, the handler `/handlers/.unknown` is invoked instead, which is always defined and which prints an error message by default.

### 55.3.6 Search Paths And Handled Keys

There is one special keys which occurs in the search path example above. What happens if we want to change a style? For example,

```
\pgfkeys{/my search path/.cd,custom/.style={variables}}
```

could mean a style in `/my search path/`, `/a/`, `/b/` or even `/b/c/!`

Due to the rules for handled keys, the answer is `/my search path/custom/.style={variables}`. It may be useful to modify this default behavior. One useful thing would be to search for *existing* styles named `custom` and redefine them. For example, if a style `/b/custom` exists, the assignment `custom/.style={variables}` should probably redefine `/b/custom` instead of `/my search path/custom`. This can be done using `handler config`:

```
This is '/b/custom'. This is '/b/custom'.Modified.
```

```

\pgfkeys{/my search path/.unknown/.code=
  {%
    \let\searchname=\pgfkeyscurrentname%
    \pgfkeysalso{%
      /a/\searchname/.try=#1,
      /b/\searchname/.retry=#1,
      /b/c/\searchname/.retry=#1%
    }%
  }%
}

% Let's define /b/custom here:
\pgfkeys{/b/custom/.code={This is '\pgfkeyscurrentkey'. }}

% Reconfigure treatment of key handlers:
\pgfkeys{/handler config=only existing}

% The search path procedure will find /b/custom
% -> leads to This is '/b/custom'
\pgfkeys{/my search path/.cd,custom}

% Due to the reconfiguration, this will find /b/custom instead of
% defining /my search path/custom:
\pgfkeys{/my search path/.cd,custom/.append code={Modified. }}

% So using the search path, we again find /b/custom which
% leads to This is '/b/custom' Modified
\pgfkeys{/my search path/.cd,custom}

```

Alternatively, the command `\pgfkeyssetdefaultpathforhandled` can be used to change the default key path for handled keys (only). For example,

```

\pgfkeyssetdefaultpathforhandled{/a}
\pgfkeys{/my search path/.cd,custom/.style={variables}}

```

leads to `/a/custom/.style`, although the remaining search ordering is unaffected. See the documentation of `\pgfkeyssetdefaultpathforhandled` for details.

A slightly different approach to search paths can be realized using the `.search also` key handler, see below.

## 55.4 Key Handlers

We now describe which key handlers are defined by default. You can also define new ones as described in Section 55.3.4.

### 55.4.1 Handlers for Path Management

Key handler `<key>/.cd`

This handler causes the default path to be set to `<key>`. Note that the default path is reset at the beginning of each call to `\pgfkeys` to be equal to `/`.

*Example:* `\pgfkeys{/tikz/.cd,...}`

Key handler `<key>/.is family`

This handler sets up things such that when `<key>` is executed, then the current path is set to `<key>`. A typical use is the following:

```

\pgfkeys{/tikz/.is family}
\pgfkeys{tikz,line width=1cm}

```

The effect of this handler is the same as if you had written `<key>/.style=<key>/.cd`, only the code produced by the `.is family` handler is quicker.

Key handler `<key>/.search also={\<path list>}`

A style which installs a `.unknown` handler into `<key>`. This `.unknown` handler will then search for unknown keys in every path provided in `{\<path list>}`.

### Invoking /secondary path/option with ‘value’

```
% define a key:
\pgfkeys{/secondary path/option/.code={Invoking /secondary path/option with ‘#1’}}

% set up a search path:
\pgfkeys{/main path/.search also={/secondary path}}

% try searching for ‘option=value’ in ‘/main path’:
% -> this finds ‘/secondary path/option’!
\pgfkeys{/main path/.cd,option=value}
```

The `.search` also handler follows the strategy

1. If a user provides a fully qualified key which could not be found, for example the full string `/main path/option`, it assume that the user new what he is doing – and does *not* continue searching for an option in  $\{\langle path list \rangle\}$ .
2. If a user provides only the key’s name, for example `option` and `option` can’t be found in the current default path (which is `/main path` in our example above), the current default path is set to the next element in  $\{\langle path list \rangle\}$  (which is `/secondary path` here) and `\pgfkeys` will be restarted. This will be iterated until either a match has been found or all elements in  $\{\langle path list \rangle\}$  have been tested.
3. If all elements in  $\{\langle path list \rangle\}$  have been checked and the key is still unknown, the fall-back handler `/handlers/.unknown` will be invoked.

### Invoking /secondary path/option with ‘value’ Found unknown option /main path/option=value!

```
% define a key:
\pgfkeys{/secondary path/option/.code={Invoking /secondary path/option with ‘#1’}}

% set up a search path:
\pgfkeys{/main path/.search also={/secondary path}}

% try searching for ‘option=value’ in ‘/main path’:
% -> this finds ‘/secondary path/option’!
\pgfkeys{/main path/.cd,option=value}

% negative example:
% try searching for fully qualified key /main path/option.
% This won’t be handled by .search also.
\pgfkeys{/handlers/.unknown/.code={Found unknown option \pgfkeyscurrentkeyRAW={#1}!}}%
\pgfkeys{/main path/.cd,/main path/option=value}
```

Please note that the strategy of `.search` also is different from the first example provided in section 55.3.5 “Unknown Keys” because `.search` also only applies only for keys which are not fully qualified.

For those who are familiar with `\pgfkeys`, the actual implementation of `.search` also might be interesting:

1. `\pgfkeys{/path/.search also={/tikz}}` is equivalent to

```
\pgfkeys{/path/.unknown/.code={%
  \ifpgfkeysaddeddefaultpath
    % only process keys for which no full path has been
    % provided:
    \pgfkeyssuccessfalse
    \let\pgfkeys@searchalso@name =\pgfkeyscurrentkeyRAW
    \ifpgfkeyssuccess
      \else
        % search with /tikz as default path:
        \pgfkeys{/tikz}{\pgfkeys@searchalso@name={#1}}%
      \fi
    \else
      \def\pgfutilnext{\pgfkeysvalueof {/handlers/.unknown/.cmd}#1\pgfeov}%
      \pgfutilnext
    \fi
  }
}
```

2. `\pgfkeys{/path/.search also={/tikz,/pgf}}` is equivalent to

```
\pgfkeys{/path/.unknown/.code={%
  \ifpgfkeysaddeddefaultpath
  \pgfkeyssuccessfalse
  \let\pgfkeys@searchalso@name=\pgfkeyscurrentkeyRAW
  \ifpgfkeyssuccess
  \else
    % step 1: search in /tikz with .try:
    \pgfqkeys{/tikz}{\pgfkeys@searchalso@name/.try={#1}}%
  \fi
  \ifpgfkeyssuccess
  \else
    % step 2: search in /pgf (without .try!):
    \pgfqkeys{/pgf}{\pgfkeys@searchalso@name={#1}}%
  \fi
\else
  \def\pgfutilnext{\pgfkeysvalueof {/handlers/.unknown/.@cmd}#1\pgfeov}%
  \pgfutilnext
\fi
}
}
```

To also enable searching for styles (or other handled keys), consider changing the configuration for handled keys to `/handler config=full` or `existing` when you use `.search also`, i.e. use

```
\pgfkeys{
  /main path/.search also={/secondary path},
  /handler config=full or existing}
```

### 55.4.2 Setting Defaults

Key handler `<key>/.default=<value>`

Sets the default value of `<key>` to `<value>`. This means that whenever no value is provided in a call to `\pgfkeys`, then this `<value>` will be used instead.

*Example:* `\pgfkeys{/width/.default=1cm}`

Key handler `<key>/.value required`

This handler causes the error message `key /erros/value required` to be issued whenever the `<key>` is used without a value.

*Example:* `\pgfkeys{/width/.value required}`

Key handler `<key>/.value forbidden`

This handler causes the error message `key /erros/value forbidden` to be issued whenever the `<key>` is used with a value.

This handler works by adding code to the code of the key. This means that you have to define the key first before you can use this handler.

```
\pgfkeys{/my key/.code=I do not want an argument!}
\pgfkeys{/my key/.value forbidden}

\pgfkeys{/my key}      % Ok
\pgfkeys{/my key=foo} % Error
```

### 55.4.3 Defining Key Codes

A number of handlers exist for defining the code of keys.

Key handler `<key>/.code=<code>`

This handler executes `\pgfkeysdef` with the parameters `<key>` and `<code>`. This means that, afterwards, whenever the `<key>` is used, the `<code>` gets executed. More precisely, when `<key>=<value>` is encountered in a key list, `<code>` is executed with any occurrence of `#1` replaced by `<value>`. As always, if no `<value>` is given, the default value is used, if defined, or the special value `\pgfkeysnovalue`.



It is permissible that  $\langle code \rangle$  calls the command `\pgfkeys`. It is also permissible the  $\langle code \rangle$  calls the command `\pgfkeysalso`, which is useful for styles, see below.

```
\pgfkeys{/par indent/.code={\parindent=#1},/par indent/.default=2em}
\pgfkeys{/par indent=1cm}
...
\pgfkeys{/par indent}
```

Key handler  $\langle key \rangle/.ecode=\langle code \rangle$

This handler works like `.code`, only the command `\pgfkeysedef` is used.

Key handler  $\langle key \rangle/.code 2 args=\langle code \rangle$

This handler works like `.code`, only two arguments rather than one are expected when the  $\langle code \rangle$  is executed. This means that when  $\langle key \rangle=\langle value \rangle$  is encountered in a key list, the  $\langle value \rangle$  should consist of two arguments. For instance,  $\langle value \rangle$  could be `{first}{second}`. Then  $\langle code \rangle$  is executed with any occurrence of `#1` replaced `first` and any occurrence of `#2` replaced by `second`.

Because of the special way the  $\langle value \rangle$  is parsed, if you set  $\langle value \rangle$  to, for instance, `first` (without any braces), then `#1` will be set to `f` and `#2` will be set to `irst`.

```
\pgfkeys{/page size/.code 2 args={\paperheight=#2\paperwidth=#1}}
\pgfkeys{/page size={30cm}{20cm}}
```

Key handler  $\langle key \rangle/.ecode 2 args=\langle code \rangle$

This handler works like `.code 2 args`, only an `\edef` is used rather than a `\def` to define the macro.

Key handler  $\langle key \rangle/.code args={\langle argument pattern \rangle}\{\langle code \rangle\}$

This handler also works like `.code`, but you can now specify an arbitrary  $\langle argument pattern \rangle$ . Such a pattern is a usual T<sub>E</sub>X macro pattern. For instance, suppose  $\langle argument pattern \rangle$  is `(#1/#2)` and  $\langle key \rangle=\langle value \rangle$  is encountered in a key list with  $\langle value \rangle$  being `(first/second)`. Then  $\langle code \rangle$  is executed with any occurrence of `#1` replaced `first` and any occurrence of `#2` replaced by `second`. So, the actual  $\langle value \rangle$  is matched against the  $\langle argument pattern \rangle$  in the standard T<sub>E</sub>X way.

```
\pgfkeys{/page size/.code args={#1 and #2}{\paperheight=#2\paperwidth=#1}}
\pgfkeys{/page size=30cm and 20cm}
```

Key handler  $\langle key \rangle/.ecode args={\langle argument pattern \rangle}\{\langle code \rangle\}$

This handler works like `.code args`, only an `\edef` is used rather than a `\def` to define the macro.

There are also handlers for modifying existing keys.

Key handler  $\langle key \rangle/.add code={\langle prefix code \rangle}\{\langle append code \rangle\}$

This handler adds code to an existing key. The  $\langle prefix code \rangle$  is added to the code stored in  $\langle key \rangle/.@cmd$  at the beginning, the  $\langle append code \rangle$  is added to this code at the end. Either can be empty. The argument list of  $\langle code \rangle$  cannot be changed using this handler. Note that both  $\langle prefix code \rangle$  and  $\langle append code \rangle$  may contain parameters like `#2`.

```
\pgfkeys{/par indent/.code={\parindent=#1}}
\newdimen\myparindent
\pgfkeys{/par indent/.add code={}\{\myparindent=#1}}
...
\pgfkeys{/par indent=1cm} % This will set both \parindent and
                          % \myparindent to 1cm
```

Key handler  $\langle key \rangle/.prefix code=\langle prefix code \rangle$

This handler is a shortcut for  $\langle key \rangle/.add code={\langle prefix code \rangle}\{\}$ . That is, this handler adds the  $\langle prefix code \rangle$  at the beginning of the code stored in  $\langle key \rangle/.@cmd$ .

Key handler  $\langle key \rangle/.append code=\langle append code \rangle$

This handler is a shortcut for  $\langle key \rangle/.add code={}\{\langle append code \rangle\}\{\}$ .



#### 55.4.4 Defining Styles

The following handlers allow you to define *styles*. A style is a key list that is processed whenever the style is given as a key in a key list. Thus, a style “stands for” a certain key value list. Styles can be parametrized just like normal code.

Key handler `<key>/.style=<key list>`

This handler set things up so that whenever `<key>=<value>` is encountered in a key list, then the `<key list>`, with every occurrence of `#1` replaced by `<value>`, is processed instead. As always, if no `<value>` is given, the default value is used, if defined, or the special value `\pgfkeysnovalue`.

You can achieve the same effect by writing `<key>/.code=\pgfkeysalso{<key list>}`. This means, in particular, that the code of a key could also first execute some normal code and only then process some further keys.

```
\pgfkeys{/par indent/.code={\parindent=#1}}
\pgfkeys{/no indent/.style={/par indent=0pt}}
\pgfkeys{/normal indent/.style={/par indent=2em}}
\pgfkeys{/no indent}
...
\pgfkeys{/normal indent}
```

The following example shows a parametrized style “in action”.

|          |                                                          |
|----------|----------------------------------------------------------|
| red box  | \begin{tikzpicture}[outline/.style={draw=#1,fill=#1!20}] |
|          | \node [outline=red] {red box};                           |
|          | \node [outline=blue] at (0,-1) {blue box};               |
| blue box | \end{tikzpicture}                                        |

Key handler `<key>/.estyle=<key list>`

This handler works like `.style`, only the `<code>` is set using `\edef` rather than `\def`. Thus, all macros in the `<code>` are expanded prior to saving the style.

For styles the corresponding handlers as for normal code exist:

Key handler `<key>/.style 2 args=<key list>`

This handler works like `.code 2 args`, only for styles. Thus, the `<key list>` may contain occurrences of both `#1` and `#2` and when the style is used, two parameters must be given as `<value>`.

```
\pgfkeys{/paper height/.code={\paperheight=#1},/paper width/.code={\paperwidth=#1}}
\pgfkeys{/page size/.style 2 args={/paper height=#1,/paper width=#2}}
\pgfkeys{/page size={30cm}{20cm}}
```

Key handler `<key>/.estyle 2 args=<key list>`

This handler works like `.style 2 args`, only an `\edef` is used rather than a `\def` to define the macro.

Key handler `<key>/.style args=<argument pattern>{<key list>}`

This handler works like `.code args`, only for styles.

Key handler `<key>/.estyle args=<argument pattern>{<code>}`

This handler works like `.ecode args`, only for styles.

Key handler `<key>/.add style=<prefix key list>{<append key list>}`

This handler works like `.add code`, only for styles. However, it is permissible to add styles to keys that have previously been set using `.code`. (It is also permissible to add normal `<code>` to a key that has previously been set using `.style`). When you add a style to a key that was previously set using `.code`, the following happens: When `<key>` is processed, the `<prefix key list>` will be processed first, then the `<code>` that was previously stored in `<key>/.@cmd`, and then the keys in `<append key list>` are processed.

```
\pgfkeys{/par indent/.code={\parindent=#1}}
\pgfkeys{/par indent/.add style={}/my key=#1}}
...
\pgfkeys{/par indent=1cm} % This will set \parindent and
                          % then execute /my key=#1
```

Key handler  $\langle key \rangle/.prefix style=\langle prefix key list \rangle$

Works like `.add style`, but only for the prefix key list.

Key handler  $\langle key \rangle/.append style=\langle append key list \rangle$

Works like `.add style`, but only for the append key list.

#### 55.4.5 Defining Value-, Macro-, If- and Choice-Keys

For some keys, the code that should be executed for them is rather “specialized.” For instance, it happens often that the code for a key just sets a certain T<sub>E</sub>X-if to true or false. For these case predefine handlers make it easier to install the necessary code.

However, we start with some handlers that are used to manage the value that is directly stored in a key.

Key handler  $\langle key \rangle/.initial=\langle value \rangle$

This handler sets the value of  $\langle key \rangle$  to  $\langle value \rangle$ . Note that no subkeys are involved. After this handler has been used, by the rules governing keys, you can subsequently change the value of the  $\langle key \rangle$  by just writing  $\langle key \rangle=\langle value \rangle$ . Thus, this handler is used to set the initial value of key.

```
\pgfkeys{/my key/.initial=red}
% "/my key" now stores the value "red"
\pgfkeys{/my key=blue}
% "/my key" now stores the value "blue"
```

Note that in the after the example, writing `\pgfkeys{/my key}` will not have the effect you might expect (namely that `blue` is inserted into the main text). Rather, `/my key` will be promoted to `/my key=\pgfkeysnovalue` and, thus, `\pgfkeysnovalue` will be stored in `/my key`.

To retrieve the value stored in a key, the handler `.get` is used.

Key handler  $\langle key \rangle/.get=\langle macro \rangle$

Executes a `\let` command so that  $\langle macro \rangle$  contains the contents stored in  $\langle key \rangle$ .

```
blue \pgfkeys{/my key/.initial=red}
      \pgfkeys{/my key=blue}
      \pgfkeys{/my key/.get=\mymacro}
      \mymacro
```

Key handler  $\langle key \rangle/.add=\{\langle prefix value \rangle\}\{\langle append value \rangle\}$

Adds the  $\langle prefix value \rangle$  and the beginning and the  $\langle append value \rangle$  at the end of the value stored in  $\langle key \rangle$ .

Key handler  $\langle key \rangle/.prefix=\{\langle prefix value \rangle\}$

Adds the  $\langle prefix value \rangle$  and the beginning of the value stored in  $\langle key \rangle$ .

Key handler  $\langle key \rangle/.append=\{\langle append value \rangle\}$

Adds the  $\langle append value \rangle$  at the end of the value stored in  $\langle key \rangle$ .

Key handler  $\langle key \rangle/.link=\langle another key \rangle$

Stores the value `\pgfkeysvalueof{\langle another key \rangle}` in the  $\langle key \rangle$ . The idea is that when you expand the  $\langle key \rangle$ , the value of  $\langle another key \rangle$  is expanded instead. This corresponds loosely to the notion of soft links in Unix, hence the name.

The next handler is useful for the common situation where  $\langle key \rangle=\langle value \rangle$  should cause the  $\langle value \rangle$  to be stored in some macro. Note that, typically, you could just as well store the value in the key itself.

Key handler  $\langle key \rangle/.store in=\langle macro \rangle$

This handler has the following effect: When you write  $\langle key \rangle=\langle value \rangle$ , the code `\def\langle macro \rangle{\langle value \rangle}` is executed. Thus, the given value is “stored” in the  $\langle macro \rangle$ .

```
Hello Gruffalo! \pgfkeys{/text/.store in=\mytext}
                  \def\a{world}
                  \pgfkeys{/text=Hello \a!}
                  \def\a{Gruffalo}
                  \mytext
```

Key handler `<key>/.estore in=<macro>`

This handler is similar to `.store in`, only the code `\edef<macro>{<value>}` is used. Thus, the macro-expanded version of `<value>` is stored in the `<macro>`.

```
Hello world! \pgfkeys{/text/.estore in=\mytext}
               \def\a{world}
               \pgfkeys{/text=Hello \a!}
               \def\a{Gruffalo}
               \mytext
```

In another common situation a key is used to set a `TeX-if` to true or false.

Key handler `<key>/.is if=<TeX-if name>`

This handler has the following effect: When you write `<key>=<value>`, it is first checked that `<value>` is true or false (the default is true if no `<value>` is given). If this is not the case, the error key `/errors/boolean expected` is executed. Otherwise, the code `\<TeX-if name><value>` is executed, which sets the `TeX-if` accordingly.

```
Round? \newif\iftheworldisflat
        \pgfkeys{/flat world/.is if=theworldisflat}
        \pgfkeys{/flat world=false}
        \iftheworldisflat
          Flat
        \else
          Round?
        \fi
```

The next handler deals with the problem when a `<key>=<value>` makes sense only for a small set of possible `<value>`s. For instance, the line cap can only be rounded or rect or butt, but nothing else. For this situation the following handler is useful.

Key handler `<key>/.is choice`

This handler set things up so that writing `<key>=<value>` will cause the subkey `<key>/<value>` to be executed. So, each of the different possible choices should be given by a subkey of `<key>`.

```
\pgfkeys{/line cap/.is choice}
\pgfkeys{/line cap/round/.style={\pgfsetbuttcap}}
\pgfkeys{/line cap/butt/.style={\pgfsetroundcap}}
\pgfkeys{/line cap/rect/.style={\pgfsetrectcap}}
\pgfkeys{/line cap/rectangle/.style={/line cap=rect}}
...
\draw [/line cap=butt] ...
```

If the subkey `<key>/<value>` does not exist, the error key `/errors/unknown choice value` is executed.

#### 55.4.6 Expanding Values

When you write `<key>=<value>`, you usually wish to use the `<value>` “as is.” Indeed, great care is taken to ensure that you can even use things like `#1` or unbalanced `TeX-ifs` inside `<value>`. However, sometimes you want the `<value>` to be expanded before it is used. For instance, `<value>` might be a macro name like `\mymacro` and you do not want `\mymacro` to be used as the macro, but rather the *contents* of `\mymacro`. Thus, instead of using `<value>` you wish to use whatever `<value>` expands to. Instead of using some fancy `\expandafter` hackery, you can use the following handlers:

Key handler `<key>/.expand once=<value>`

This handler expands `<value>` once (more precisely, it executes an `\expandafter` command on the first token of `<value>`) and then process the resulting `<result>` as if you had written `<key>=<result>`. Note that if `<key>` contains a handler itself, this handler will be called normally.

|               |                                                                                                                                                                                                                                                                                                                                                                                                                         |
|---------------|-------------------------------------------------------------------------------------------------------------------------------------------------------------------------------------------------------------------------------------------------------------------------------------------------------------------------------------------------------------------------------------------------------------------------|
| Key 1: \c     | \def\c{\b}                                                                                                                                                                                                                                                                                                                                                                                                              |
| Key 2: \b     | \def\b{\a}                                                                                                                                                                                                                                                                                                                                                                                                              |
| Key 3: \a     | \def\c{\b}                                                                                                                                                                                                                                                                                                                                                                                                              |
| Key 4: bottom | <pre> \pgfkeys{/key1/.initial=\c} \pgfkeys{/key2/.initial/.expand once=\c} \pgfkeys{/key3/.initial/.expand twice=\c} \pgfkeys{/key4/.initial/.expanded=\c}  \def\a{{\ttfamily\string\a}} \def\b{{\ttfamily\string\b}} \def\c{{\ttfamily\string\c}}  \begin{tabular}{l} Key 1:&amp; \pgfkeys{/key1} \\ Key 2:&amp; \pgfkeys{/key2} \\ Key 3:&amp; \pgfkeys{/key3} \\ Key 4:&amp; \pgfkeys{/key4} \end{tabular&gt; </pre> |

Key handler  $\langle key \rangle/.expand\ twice=\langle value \rangle$

This handler works like saying  $\langle key \rangle/.expand\ once/.expand\ once=\langle value \rangle$ .

Key handler  $\langle key \rangle/.expanded=\langle value \rangle$

This handler will completely expand  $\langle value \rangle$  (using  $\backslashedef$ ) before processing  $\langle key \rangle=\langle result \rangle$ .

#### 55.4.7 Handlers for Testing Keys

Key handler  $\langle key \rangle/.try=\langle value \rangle$

This handler causes the same things to be done as if  $\langle key \rangle=\langle value \rangle$  had been written instead. However, if neither  $\langle key \rangle/.cmd$  nor the key itself is defined, no handlers will be called. Instead, the execution of the key just stops. Thus, this handler will “try” to use the key, but no further action is taken when the key is not defined.

The  $\text{\TeX}$ -if  $\backslashifpgfkeyssuccess$  will be set according to whether the  $\langle key \rangle$  was successfully executed or not.

|                   |                                                                                                                   |
|-------------------|-------------------------------------------------------------------------------------------------------------------|
| (a:hallo)(b:welt) | <pre> \pgfkeys{/a/.code=(a:#1)} \pgfkeys{/b/.code=(b:#1)} \pgfkeys{/x/.try=hmm,/a/.try=hallo,/b/.try=welt} </pre> |
|-------------------|-------------------------------------------------------------------------------------------------------------------|

Key handler  $\langle key \rangle/.retry=\langle value \rangle$

This handler works just like  $.try$ , only it will not do anything if  $\backslashifpgfkeyssuccess$  is false. Thus, this handler will only retry to set a key if “the last attempt failed”.

|           |                                                                                                                       |
|-----------|-----------------------------------------------------------------------------------------------------------------------|
| (a:hallo) | <pre> \pgfkeys{/a/.code=(a:#1)} \pgfkeys{/b/.code=(b:#1)} \pgfkeys{/x/.try=hmm,/a/.retry=hallo,/b/.retry=welt} </pre> |
|-----------|-----------------------------------------------------------------------------------------------------------------------|

Key handler  $\langle key \rangle/.lastretry=\langle value \rangle$

This handler works like  $.retry$ , only it will invoke the usual handlers for unknown keys if  $\backslashifpgfkeyssuccess$  is false. Thus, this handlers will only try to set a key if “the last attempt failed”. Furthermore, this here is the last such attempt.

#### 55.4.8 Handlers for Key Inspection

Key handler  $\langle key \rangle/.show\ value$

This handler executes a  $\backslashshow$  command on the value stored in  $\langle key \rangle$ . This is useful mostly for debugging.

*Example:*  $\backslashpgfkeys{/my/obscure\ key/.show\ value}$

Key handler  $\langle key \rangle/.show\ code$

This handler executes a `\show` command on the code stored in  $\langle key \rangle/.@cmd$ . This is useful mostly for debugging.

*Example:* `\pgfkeys{/my/obscure key/.show code}`

The following key is not a handler, but it also commonly used for inspecting things:

`/utils/exec= $\langle code \rangle$`  (no default)

This key will simply execute the given  $\langle code \rangle$ .

*Example:* `\pgfkeys{some key=some value,/utils/exec=\show\hallo,obscure key=obscure}`

## 55.5 Error Keys

In certain situations errors can occur, like using an undefined key. In these situations error keys are executed. They should store a macro that gets two arguments: The first is the offending key (possibly only after macro expansion), the second is the value that was passed as a parameter (also possibly only after macro expansion).

Currently, error keys are simply executed. In the future it might be a good idea to have different subkeys that are executed depending on the language currently set so that users get a localized error message.

`/errors/value required= $\{\langle offending key \rangle\}\{\langle value \rangle\}$`  (no default)

This key is executed whenever an  $\langle offending key \rangle$  is used without a value when a value is actually required.

`/errors/value forbidden= $\{\langle offending key \rangle\}\{\langle value \rangle\}$`  (no default)

This key is executed whenever a key is used with a value when a value is actually forbidden.

`/errors/boolean expected= $\{\langle offending key \rangle\}\{\langle value \rangle\}$`  (no default)

This key is executed whenever a key setup using `.is if` gets called with a  $\langle value \rangle$  other than `true` or `false`.

`/errors/unknown choice value= $\{\langle offending key \rangle\}\{\langle value \rangle\}$`  (no default)

This key is executed whenever a choice is used as a  $\langle value \rangle$  for a key setup using the `.is choice` handler that is not defined.

`/errors/unknown key= $\{\langle offending key \rangle\}\{\langle value \rangle\}$`  (no default)

This key is executed whenever a key is unknown and no specific `.unknown` handler is found.

## 55.6 Key filtering

*An extension by Christian Feuersänger*

Normally, a call to `\pgfkeys` sets all keys provided in its argument list. This is usually what users expect it to do. However, implementations of different packages or PGF-libraries may need more control over the key setting procedure: library A may want to set its options directly and communicate all remaining ones to library B.

This section describes key filtering methods of PGF, including options for family groupings. If you merely want to use PGF (or its libraries), you can skip this section. It is addressed to package (or library) authors.

### 55.6.1 Starting with an example

Users of `xkeyval` are familiar with the concept of key families: keys belong to groups and those keys can be ‘filtered’ out of other options. PGF supports family groupings and more abstract key selection mechanism with `\pgfkeysfiltered`, a variant of `\pgfkeys`. Suppose we have the example key grouping

```
\pgfkeys{
/my group/A1/.code=(A1:#1),
/my group/A2/.code=(A2:#1),
/my group/A3/.code=(A3:#1),
/my group/B/.code=(B:#1),
/my group/C/.code=(B:#1),
}
```

and we want to set options A1, A2 and A3 only. A call to `\pgfkeys` yields

```
(A1:a1)(A2:a2)(B:b)(C:c) \pgfkeys{/my group/A1=a1, /my group/A2=a2, /my group/B=b, /my group/C=c}
```

because all those command option are processed consecutively.

Now, let's define a family named A which contains A1, A2 and A3 and set only family members of A. We prepare our key settings with

```
\pgfkeys{
/my group/A/.is family,
/my group/A1/.belongs to family=/my group/A,
/my group/A2/.belongs to family=/my group/A,
/my group/A3/.belongs to family=/my group/A,
}
```

and

```
\pgfkeys{/pgf/key filters/active families/.install key filter}
```

After this preparation, we can use `\pgfkeysfiltered` with

```
(A1:a1)(A2:a2) \pgfkeys{/my group/A/.activate family}
\pgfkeysfiltered{/my group/A1=a1, /my group/A2=a2,
/my group/B=b, /my group/C=c}
```

or

```
(A1:a1)(A2:a2)(A3:a3) \pgfkeys{/my group/A/.activate family}
\pgfkeysfiltered{/my group/A1=a1, /my group/A2=a2,
/my group/B=b, /my group/C=c, /tikz/color=blue, /my group/A3=a3}
```

to set only keys which belong to an 'active' family – in our case, only family A was active, so the remaining options have not been processed. The family processing is quite fast and allows an arbitrary number of active key families.

Unprocessed options can be collected into a macro (similar to `xkeyval`'s `\xkv@rm`), discarded or handled manually. The details of key selection and family declaration are described in the following sections.

### 55.6.2 Setting filters

The command `\pgfkeysfiltered` is the main tool to process only selected options. It works as follows.

**`\pgfkeysfiltered`**`{⟨key-value-list⟩}`

Processes all options in exactly the same way as `\pgfkeys``{⟨key-value-list⟩}`, but a key filter is considered as soon as key identification is complete.

The key filter tells `\pgfkeysfiltered` whether it should continue to apply the current option (return value is 'true') or whether something different shall be done (filter returns 'false').

There is exactly one key filter in effect, and it is installed by the `.install key filter` handler or by `\pgfkeysinstallkeyfilter`.

If the key filter returns 'false', a unique key filter handler gets control. This handler is installed by the `.install key filter handler` method and has access to the key's full name, value and (possibly) path.

Key filtering applies to any (possibly nested) call to `\pgfkeys`, `\pgfkeysalso`, `\pgfqkeys` and `\pgfqkeysalso` during the evaluation of `{⟨key-value-list⟩}`. It does *not* apply to routines like `\pgfkeyssetvalue` or `\pgfkeysgetvalue`. Furthermore, keys belonging to `/errors` are always processed. Key filtering routines can't be nested: you can't combine different key filters automatically.

**`\pgfqkeysfiltered`**`{⟨default-path⟩}{⟨key-value-list⟩}`

A variant of `\pgfkeysfiltered` which uses the 'quick' search path setting. It is the `\pgfqkeys` variant of `\pgfkeysfiltered`, see the documentation for `\pgfqkeys` for more details.

**`\pgfkeysalsofrom`**`{⟨macro⟩}`

A variant of `\pgfkeysalso` which loads its key list from `{⟨macro⟩}`.

It is useful in conjunction with the `/pgf/key filter handlers/append filtered to=⟨macro⟩` handler.

The following example uses the same settings as in the intro section 55.6.1.

```
(A1:a1)(A2:a2)(A3:a3)Remaining: '/my group/B=b,/my group/C=c,/tikz/color=blue'.(B:b)(B:c)
```

```
\pgfkeys{/pgf/key filter handlers/append filtered to/.install key filter handler=\remainingoptions}
\def\remainingoptions{}
\pgfkeysfiltered{/my group/A1=a1, /my group/A2=a2,
/my group/B=b, /my group/C=c, /tikz/color=blue, /my group/A3=a3}

Remaining: '\remainingoptions'.
\pgfkeysalsofrom{\remainingoptions}
```

**\pgfkeysalsofiltered**{*<key-value-list>*}

This command works as `\pgfkeysfiltered`, but it does not change the current default path. See the documentation of `\pgfkeysalso` for more details.

**\pgfkeysalsofilteredfrom**{*<macro>*}

A variant of `\pgfkeysalsofiltered` which loads its key list from *<macro>*.

Key handler *<key>*/.install key filter=*<optional arguments>*

This handler install a key filter. A key filter is a command key which sets the  $\TeX$ -boolean `\ifpgfkeysfiltercontinue`, that means a key with existing `'/.@cmd'` suffix. A simple example is a key filter which returns always true:

```
\pgfkeys{/foo/bar/true key filter/.code={\pgfkeysfiltercontinuetrue}}
\pgfkeys{/foo/bar/true key filter/.install key filter}
```

If key filters require arguments, they are installed by `.install key filter` as well. An example is the `/pgf/key filters>equals` handler:

```
(A1:a1) \pgfkeys{/pgf/key filters>equals/.install key filter={/my group/A1}}
\pgfkeysfiltered{/my group/A1=a1, /my group/A2=a2,
/my group/B=b, /my group/C=c, /tikz/color=blue, /my group/A3=a3}
```

If a key filter requires more than one argument, you need to provide the complete argument listing in braces like `{{first}{second}}`.

You can also use `\pgfkeysinstallkeyfilter`*<full key>**<optional arguments>*, it has the same effect.

See section 55.6.7 for how to write key filters.

Key handler *<key>*/.install key filter handler=*<optional arguments>*

This handler installs the routine which will be invoked for every *unprocessed* option, that means any option for which the key filter returned `'false'`.

The `.install key filter handler` is used in the same way as `.install key filter`. There exists a macro version, `\pgfkeysinstallkeyfilterhandler`*<full key>**<optional arguments>*, which has the same effect.

See section 55.6.7 for how to write key filter handlers.

### 55.6.3 Handlers for unprocessed keys

Each option for which key filters decided to skip them is handed over to a 'key filter handler'. There are several predefined key filter handlers.

**/pgf/key filter handlers/append filtered to**={*<macro>*} (no default)

Install this filter handler to append any unprocessed options to macro *<macro>*.

```
(A1:a1)(A2:a2)Remaining options: '/my group/B=b,/my group/C=c,/tikz/color=blue'.
```

```
\pgfkeys{/pgf/key filter handlers/append filtered to/.install key filter handler=\remainingoptions}
\def\remainingoptions{}
\pgfkeysfiltered{/my group/A1=a1, /my group/A2=a2,
/my group/B=b, /my group/C=c, /tikz/color=blue}

Remaining options: '\remainingoptions'.
```

This example uses the same keys as defined in the intro section 55.6.1.



`/pgf/key filter handlers/ignore` (no value)

Install this filter handler if you simply want to ignore any unprocessed option. This is the default.

`/pgf/key filter handlers/log` (no value)

This key filter handler writes messages for any unprocessed option to your logfile (and terminal).

#### 55.6.4 Family support

PGFSupports a family concept: every option can be associated with (at most) one family. Families form loose key groups which are independent of the key hierarchy. For example, `/my tree/key1` can belong to family `/tikz`.

It is possible to ‘activate’ or ‘deactivate’ single families. Furthermore, it is possible to set only keys which belong to active families using appropriate key filter handlers.

The family support is fast: if there are  $N$  options in a key-value-list and there are  $K$  active families, the runtime for `\pgfkeysfiltered` is  $O(N + K)$  (activate every family  $O(K)$ , check every option  $O(N)$ , deactivate every family  $O(K)$ ).

Key handler `\pgfkeys{/key/.is family}`

Defines a new family. This option has already been described in section 55.4.1 on page 485.

Key handler `\pgfkeys{/key/.activate family}`

Activates a family. The family needs to be defined, otherwise `/errors/family unknown` will be raised. Activation means a `TEX-boolean` will be set to `true`, indicating that a family should be processed.

You can also use `\pgfkeysactivatefamily{full path}` to get the same effect. Furthermore, you can use `\pgfkeysactivatefamilies{list of families}{macro name for de-activation}` to activate a list of families (see section 55.6.6).

Key handler `\pgfkeys{/key/.deactivate family}`

Deactivates a family. The family needs to be defined, otherwise `/errors/family unknown` will be raised.

You can also use `\pgfkeysdeactivatefamily{full path}` to get the same effect.

Key handler `\pgfkeys{/key/.belongs to family={family name}}`

Associates the current option with `{family name}`, which is expected to be a full path of a family.

```
\pgfkeys{/foo/bar/.is family}
\pgfkeys{
/fo/a/.belongs to family=/foo/bar,
/fo/b/.belongs to family=/foo/bar
}
```

Each option can have up to one family, `.belongs to family` overwrites any old setting.

`/pgf/key filters/active families` (no value)

Install this key filter if `\pgfkeysfiltered` should only process activated families. If a key does not belong to any family, it is not processed. If a key is completely unknown within the default path, the normal ‘unknown’ handlers of `\pgfkeys` are invoked.

`/pgf/key filters/active families or no family={key filter 1}{key filter 2}` (no default)

This key filter configures `\pgfkeysfiltered` to work as follows.

1. If the current key belongs to a family, set `\ifpgfkeysfiltercontinue` to true if and only if its family is active.
2. If the current key does *not* belong to a family, assign `\ifpgfkeysfiltercontinue` as result of `{key filter 1}`.
3. If the current key is unknown within the default path, assign `\ifpgfkeysfiltercontinue` as result of `{key filter 2}`.



The arguments  $\langle key\ filter\ 1 \rangle$  and  $\langle key\ filter\ 2 \rangle$  are other key filters (possibly with options) and allow fine-grained control over the filtering process.

```
\pgfkeysinstallkeyfilter
{/pgf/key filters/active families or no family}
{{/pgf/key filters/is descendant of=/tikz}% for keys without family
{/pgf/key filters/false}% for unknown keys
}%
```

This key filter will return true for any option with active family. If an option has no family, the return value is true if and only if it belongs to `/tikz`. If the option is unknown, the return value is `false` and unknown handlers won't be called.

`/pgf/key filters/active families or no family DEBUG= $\langle key\ filter\ 1 \rangle$  $\langle key\ filter\ 2 \rangle$`  (no default)

A variant of `active families or no family` which protocols each action on your terminal (log-file).

`\pgfkeysactivatefamiliesandfilteroptions $\langle family\ list \rangle$  $\langle key-value-list \rangle$`

A simple shortcut macro which activates any family in the comma separated  $\langle family\ list \rangle$ , invokes `\pgfkeysfiltered $\langle key-value-list \rangle$`  and deactivates the families afterwards.

Please note that you will need to install a family key filter, otherwise family activation has no effect.

`\pgfqkeysactivatefamiliesandfilteroptions $\langle default\ path \rangle$  $\langle family\ list \rangle$  $\langle key-value-list \rangle$`

The 'quick' default path variant of `\pgfkeysactivatefamiliesandfilteroptions`.

`\pgfkeysactivatesinglefamilyandfilteroptions $\langle family\ name \rangle$  $\langle key-value-list \rangle$`

A shortcut macro which activates a single family and invokes `\pgfkeysfiltered`.

Please note that you will need to install a family key filter, otherwise family activation has no effect.

`\pgfqkeysactivatesinglefamilyandfilteroptions $\langle default\ path \rangle$  $\langle family\ name \rangle$  $\langle key-value-list \rangle$`

The 'quick' default path variant of `\pgfkeysactivatesinglefamilyandfilteroptions`.

### 55.6.5 Other key filters

There are some more key filters which have nothing to do with family handling.

`/pgf/key filters/is descendant of= $\langle path \rangle$`  (no default)

Install this key filter to process only options belonging to the key tree  $\langle path \rangle$ . It returns true for every key which has key path  $\langle path \rangle$ . It also returns true for any unknown key, that means unknown keys are processed using the standard unknown handlers of PGF.

|                         |                                                                                                                                                                                                                                          |
|-------------------------|------------------------------------------------------------------------------------------------------------------------------------------------------------------------------------------------------------------------------------------|
| <code>(A:a)(B:b)</code> | <pre>\pgfkeys{ /group 1/A/.code={A:#1}, /group 1/foo/bar/B/.code={B:#1}, /group 2/C/.code={C:#1}, /pgf/key filters/is descendant of/.install key filter=/group 1} \pgfkeysfiltered{/group 1/A=a,/group 1/foo/bar/B=b,/group 2/C=c}</pre> |
|-------------------------|------------------------------------------------------------------------------------------------------------------------------------------------------------------------------------------------------------------------------------------|

`/pgf/key filters>equals= $\langle full\ key \rangle$`  (no default)

Install this key filter to process only the fully qualified option  $\langle full\ key \rangle$ . The filter returns true for any unknown key or if the key equals  $\langle full\ key \rangle$ .

|                    |                                                                                                                                                                        |
|--------------------|------------------------------------------------------------------------------------------------------------------------------------------------------------------------|
| <code>(A:a)</code> | <pre>\pgfkeys{ /group 1/A/.code={A:#1}, /group 1/B/.code={B:#1}, /pgf/key filters&gt;equals/.install key filter=/group 1/A} \pgfqkeysfiltered{/group 1}{A=a,B=b}</pre> |
|--------------------|------------------------------------------------------------------------------------------------------------------------------------------------------------------------|

`/pgf/key filters/not= $\langle key\ filter \rangle$`  (no default)

This key filter logically inverts the result of  $\langle key\ filter \rangle$ .

```
(C:c) \pgfkeys{
/group 1/A/.code={A:#1},
/group 1/foo/bar/B/.code={B:#1},
/group 2/C/.code={C:#1},
/pgf/key filters/not/.install key filter=
{/pgf/key filters/is descendant of=/group 1}}
\pgfkeysfiltered{/group 1/A=a,/group 1/foo/bar/B=b,/group 2/C=c}
```

`/pgf/key filters/and={⟨key filter 1⟩}{⟨key filter 2⟩}` (no default)

This key filter returns true if and only if both, `{⟨key filter 1⟩}` and `{⟨key filter 2⟩}` return true.

`/pgf/key filters/or={⟨key filter 1⟩}{⟨key filter 2⟩}` (no default)

This key filter returns true if one of `{⟨key filter 1⟩}` and `{⟨key filter 2⟩}` returns true.

`/pgf/key filters/true` (no value)

This key filter returns always true.

`/pgf/key filters/false` (no value)

This key filter returns always false.

`/pgf/key filters/defined` (no value)

This key filter returns false if the current key is unknown, which avoids calling the unknown handlers.

### 55.6.6 Programmer Interface

`\pgfkeysinterruptkeyfilter`

*⟨environment contents⟩*

`\endpgfkeysinterruptkeyfilter`

Temporarily disables key filtering inside of the environment. If key filtering is not active, this has no effect at all.

Please note that no  $\TeX$ -group is introduced.

`\pgfkeyssavekeyfilterstateto{⟨macro⟩}`

Creates `{⟨macro⟩}` which contains commands to re-activate the current key filter and key filter handler. It can be used to temporarily switch the key filter.

`\pgfkeysinstallkeyfilter{⟨full key⟩}{⟨optional arguments⟩}`

The command `\pgfkeysinstallkeyfilter{⟨full key⟩}{⟨optional arguments⟩}` has the same effect as `\pgfkeys{⟨full key⟩/.install key filter={⟨optional arguments⟩}}`.

`\pgfkeysinstallkeyfilterhandler{⟨full key⟩}{⟨optional arguments⟩}`

The command `\pgfkeysinstallkeyfilterhandler{⟨full key⟩}{⟨optional arguments⟩}` has the same effect as `\pgfkeys{⟨full key⟩/.install key filter handler={⟨optional arguments⟩}}`.

`\pgfkeysactivatefamily{⟨family name⟩}`

Equivalent to `\pgfkeys{⟨family name⟩/.activate family}`.

`\pgfkeysdeactivatefamily{⟨family name⟩}`

Equivalent to `\pgfkeys{⟨family name⟩/.dactivate family}`.

`\pgfkeysactivatefamilies{⟨family list⟩}{⟨deactivate macro name⟩}`

Activates each family in `⟨family list⟩` and creates a macro `⟨deactivate macro name⟩` which de-activates each family in `⟨family list⟩`.

```
\pgfkeysactivatefamilies{/family 1,/family 2,/family 3}{\deactivatename}
\pgfkeysfiltered{foo,bar}
\deactivatename
```

`\pgfkeysiffamilydefined{<family>}{<true case>}{<>false case>}`

Checks whether the full key `<family>` is a family and executes either `<true case>` or `<>false case>`.

`\pgfkeysisfamilyactive{<family>}`

Sets the TeX-boolean `\ifpgfkeysfiltercontinue` to whether `<family>` is active or not.

`\pgfkeysgetfamily{<key>}{<resultmacro>}`

Returns the family associated to a full key `<key>` into macro `<resultmacro>`.

### 55.6.7 Defining own filters or filter handlers

During `\pgfkeysfiltered`, the key filter code will be invoked. At this time, the full key path including key name is available as `\pgfkeyscurrentkey`, the key name before default paths have been considered as `\pgfkeyscurrentkeyRAW` and the values as `\pgfkeyscurrentvalue`.

Furthermore, the macro `\pgfkeyscasenum` contains the current key's type as an integer:

`<1>` The key is a command key (i.e. `.../.@cmd` exists).

`<2>` The key contains its value directly.

`<3>` The key is handled (for example it is `.code` or `.cd`).

In this case, the macros `\pgfkeyscurrentname` and `\pgfkeyscurrentpath` are set to the handlers name and path, respectively. Invoke `\pgfkeyssplitpath{}` to extract these values for non-handled keys.

`<0>` The key is unknown.

Any key filter or key filter handler can access these variables. Key filters are expected to set the TeX-boolean `\ifpgfkeysfiltercontinue` to whether the current key shall be processed or not.

`\pgfkeysevalkeyfilterwith{<full key>}={<filter arguments>}`

Evaluates a fully qualified key filter `<full key>` with argument(s) `<filter arguments>`.

```
\pgfkeysevalkeyfilterwith{/pgf/key filters>equals=tikz}
```

## 56 Repeating Things: The Foreach Statement

This section describes the package `pgffor`, which is loaded automatically by `TikZ`, but not by `PGF`:

```
\usepackage{pgffor} %  $\TeX$ 
\input pgffor.tex % plain  $\TeX$ 
\usemodule{pgffor} % Con $\TeX$ t
```

This package can be used independently of `PGF`, but works particularly well together with `PGF` and `TikZ`. It defines two new commands: `\foreach` and `\breakforeach`.

`\foreach`  $\langle$ variables $\rangle$  [ $\langle$ options $\rangle$ ] in  $\langle$ list $\rangle$   $\langle$ commands $\rangle$

The syntax of this command is a bit complicated, so let us go through it step-by-step.

In the easiest case,  $\langle$ variables $\rangle$  is a single  $\TeX$ -command like `\x` or `\point`. (If you want to have some fun, you can also use active characters. If you do not know what active characters are, you are blessed.)

Still in the easiest case,  $\langle$ options $\rangle$  will be omitted. The keys for customising this command will be discussed below.

Again, in the easiest case,  $\langle$ list $\rangle$  is either a comma-separated list of values surrounded by curly braces or it is the name of a macro that contain such a list of values. Anything can be used as a value, but numbers are most likely.

Finally, in the easiest case,  $\langle$ commands $\rangle$  is some  $\TeX$ -text in curly braces.

With all these assumptions, the `\foreach` statement will execute the  $\langle$ commands $\rangle$  repeatedly, once for every element of the  $\langle$ list $\rangle$ . Each time the  $\langle$ commands $\rangle$  are executed, the  $\langle$ variable $\rangle$  will be set to the current value of the list item.

```
[1][2][3][0] \foreach \x in {1,2,3,0} {\x}
```

```
[1][2][3][0] \def\mylist{1,2,3,0}
\foreach \x in \mylist {\x}
```

Note that in each execution of  $\langle$ commands $\rangle$  the  $\langle$ commands $\rangle$  are put in a  $\TeX$  group. This means that *local changes to counters inside  $\langle$ commands $\rangle$  do not persist till the next iteration*. For instance, if you add 1 to a counter inside  $\langle$ commands $\rangle$  locally, then in the next iteration the counter will have the same value it had at the beginning of the first iteration. You have to add `\global` if you wish changes to persist from iteration to iteration.

**Syntax for the commands.** Let us move on to a more complicated setting. The first complication occurs when the  $\langle$ commands $\rangle$  are not some text in curly braces. If the `\foreach` statement does not encounter an opening brace, it will instead scan everything up to the next semicolon and use this as  $\langle$ commands $\rangle$ . This is most useful in situations like the following:

```
○ ○ ○ ○ \tikz
\foreach \x in {0,1,2,3}
\draw (\x,0) circle (0.2cm);
```

However, the “reading till the next semicolon” is not the whole truth. There is another rule: If a `\foreach` statement is directly followed by another `\foreach` statement, this second `foreach` statement is collected as  $\langle$ commands $\rangle$ . This allows you to write the following:

```
● ● ● ● \begin{tikzpicture}
\foreach \x in {0,1,2,3}
\foreach \y in {0,1,2,3}
{
\draw (\x,\y) circle (0.2cm);
\fill (\x,\y) circle (0.1cm);
}
\end{tikzpicture}
```

**The dots notation.** The second complication concerns the  $\langle$ list $\rangle$ . If this  $\langle$ list $\rangle$  contains the list item “...”, this list item is replaced by the “missing values.” More precisely, the following happens:

Normally, when a list item  $\dots$  is encountered, there should already have been *two* list items before it, which were numbers. Examples of *numbers* are 1, -10, or -0.24. Let us call these numbers  $x$  and  $y$  and let  $d := y - x$  be their difference. Next, there should also be one number following the three dots, let us call this number  $z$ .

In this situation, the part of the list reading “ $x, y, \dots, z$ ” is replaced by “ $x, x + d, x + 2d, x + 3d, \dots, x + md$ ,” where the last dots are semantic dots, not syntactic dots. The value  $m$  is the largest number such that  $x + md \leq z$  if  $d$  is positive or such that  $x + md \geq z$  if  $d$  is negative.

Perhaps it is best to explain this by some examples: The following  $\langle list \rangle$  have the same effects:

```
\foreach \x in {1,2,...,6} {\x, } yields 1, 2, 3, 4, 5, 6,
\foreach \x in {1,2,3,...,6} {\x, } yields 1, 2, 3, 4, 5, 6,
\foreach \x in {1,3,...,11} {\x, } yields 1, 3, 5, 7, 9, 11,
\foreach \x in {1,3,...,10} {\x, } yields 1, 3, 5, 7, 9,
\foreach \x in {0,0.1,...,0.5} {\x, } yields 0, 0.1, 0.20001, 0.30002, 0.40002,
\foreach \x in {a,b,9,8,...,1,2,2.125,...,2.5} {\x, } yields a, b, 9, 8, 7, 6, 5, 4, 3, 2, 1, 2,
2.125, 2.25, 2.375, 2.5,
```

As can be seen, for fractional steps that are not multiples of  $2^{-n}$  for some small  $n$ , rounding errors can occur pretty easily. Thus, in the second last case, 0.5 should probably be replaced by 0.501 for robustness.

There is another special case for the  $\dots$  statement: If the  $\dots$  is used right after the first item in the list, that is, if there is an  $x$ , but no  $y$ , the difference  $d$  obviously cannot be computed and is set to 1 if the number  $z$  following the dots is larger than  $x$  and is set to -1 if  $z$  is smaller:

```
\foreach \x in {1,...,6} {\x, } yields 1, 2, 3, 4, 5, 6,
\foreach \x in {9,...,3.5} {\x, } yields 9, 8, 7, 6, 5, 4,
```

There is yet a further special case for the  $\dots$  statement, in that it can indicate an alphabetic character sequence:

```
\foreach \x in {a,...,m} {\x, } yields a, b, c, d, e, f, g, h, i, j, k, l, m,
\foreach \x in {Z,X,...,M} {\x, } yields Z, X, V, T, R, P, N,
```

A final special case for the  $\dots$  statement is contextual replacement. If the  $\dots$  is used in some context, for example,  $\sin(\dots)$ , this context will be interpreted correctly, provided that the list items prior to the  $\dots$  statement have *exactly* the same pattern, except that, instead of dots, they have a number or a character:

```
\foreach \x in {2^1,2^... ,2^7} {\x, } yields 2^1, 2^2, 2^3, 2^4, 2^5, 2^6, 2^7,
\foreach \x in {0\pi,0.5\pi,...\pi,3\pi} {\x, } yields 0\pi, 0.5\pi, 1\pi, 1.5\pi, 2\pi, 2.5\pi, 3\pi,
\foreach \x in {A_1,..._1,H_1} {\x, } yields A_1, B_1, C_1, D_1, E_1, F_1, G_1, H_1,
```

**Special handling of pairs.** Different list items are separated by commas. However, this causes a problem when the list items contain commas themselves as pairs like (0,1) do. In this case, you should put the items containing commas in braces as in {(0,1)}. However, since pairs are such a natural and useful case, they get a special treatment by the  $\text{\foreach}$  statement. When a list item starts with a ( everything up to the next ) is made part of the item. Thus, we can write things like the following:

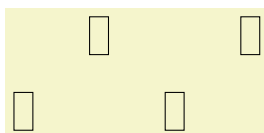

```
\tikz
\foreach \position in {(0,0), (1,1), (2,0), (3,1)}
\draw \position rectangle +(0.25,0.5);
```

**Using the foreach-statement inside paths.** TikZ allows you to use a  $\text{\foreach}$  statement inside a path construction. In such a case, the  $\langle commands \rangle$  must be path construction commands. Here are two examples:

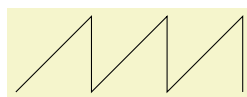

```
\tikz
\draw (0,0)
\foreach \x in {1,...,3}
{ -- (\x,1) -- (\x,0) }
;
```

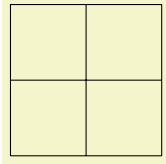

```
\tikz \draw \foreach \p in {1,...,3} {(\p,1)--(\p,3) (1,\p)--(3,\p)};
```

**Multiple variables.** You will often wish to iterate over two variables at the same time. Since you can nest `\foreach` loops, this is normally straight-forward. However, you sometimes wish variables to iterate “simultaneously.” For example, we might be given a list of edges that connect two coordinates and might wish to iterate over these edges. While doing so, we would like the source and target of the edges to be set to two different variables.

To achieve this, you can use the following syntax: The  $\langle variables \rangle$  may not only be a single  $\text{\TeX}$ -variable. Instead, it can also be a list of variables separated by slashes ( $/$ ). In this case the list items can also be lists of values separated by slashes.

Assuming that the  $\langle variables \rangle$  and the list items are lists of values, each time the  $\langle commands \rangle$  are executed, each of the variables in  $\langle variables \rangle$  is set to one part of the list making up the current list item. Here is an example to clarify this:

*Example:* `\foreach \x / \y in {1/2,a/b} {'\x' and '\y'}` yields “1 and 2” “a and b”.

If some entry in the  $\langle list \rangle$  does not have “enough” slashes, the last entry will be repeated. Here is an example:

```
0 1 2 e 3
```

```
\begin{tikzpicture}
  \foreach \x/\xtext in {0,...,3,2.72 / e}
    \draw (\x,0) node{${\xtext}$};
\end{tikzpicture}
```

Here are more useful examples:

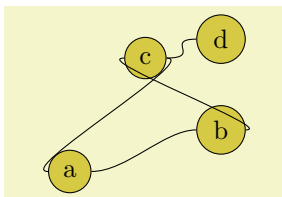

```
\begin{tikzpicture}
% Define some coordinates:
\path[nodes={circle,fill=examplefill,draw}]
(0,0) node(a) {a}
(2,0.55) node(b) {b}
(1,1.5) node(c) {c}
(2,1.75) node(d) {d};

% Draw some connections:
\foreach \source/\target in {a/b, b/c, c/a, c/d}
  \draw (\source) .. controls +(.75cm,0pt) and +(-.75cm,0pt)..(\target);
\end{tikzpicture}
```

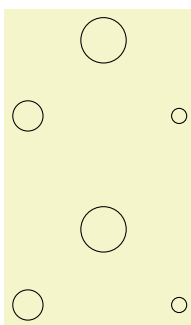

```
\begin{tikzpicture}
% Let's draw circles at interesting points:
\foreach \x / \y / \diameter in {0 / 0 / 2mm, 1 / 1 / 3mm, 2 / 0 / 1mm}
  \draw (\x,\y) circle (\diameter);

% Same effect
\foreach \center/\diameter in {(0,0)/2mm}, {(1,1)/3mm}, {(2,0)/1mm}
  \draw[yshift=2.5cm] \center circle (\diameter);
\end{tikzpicture}
```

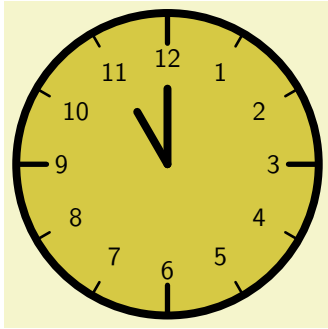

```
\begin{tikzpicture}[line cap=round,line width=3pt]
  \filldraw [fill=examplefill] (0,0) circle (2cm);

  \foreach \angle / \label in
    {0/3, 30/2, 60/1, 90/12, 120/11, 150/10, 180/9,
     210/8, 240/7, 270/6, 300/5, 330/4}
  {
    \draw[line width=1pt] (\angle:1.8cm) -- (\angle:2cm);
    \draw (\angle:1.4cm) node{\textsf{\label}};
  }

  \foreach \angle in {0,90,180,270}
    \draw[line width=2pt] (\angle:1.6cm) -- (\angle:2cm);

  \draw (0,0) -- (120:0.8cm); % hour
  \draw (0,0) -- (90:1cm);   % minute
\end{tikzpicture}%
```

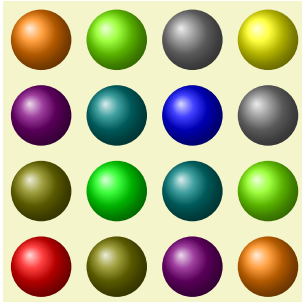

```
\tikz[shading=ball]
\foreach \x / \cola in {0/red,1/green,2/blue,3/yellow}
\foreach \y / \colb in {0/red,1/green,2/blue,3/yellow}
  \shade[ball color=\cola!50!\colb] (\x,\y) circle (0.4cm);
```

### Options to customise the foreach-statement.

The keys described below can be used in the  $\langle options \rangle$  argument to the `\foreach` command. They all have the path `/pgf/foreach/`, however, the path is set automatically when  $\langle options \rangle$  are parsed, so it does not have to be explicitly stated.

`/pgf/foreach/var= $\langle variable \rangle$`  (no default)

This key provides an alternative way to specify variables: `\foreach [var= $\x$ ,var= $\y$ ]` is the same as `\foreach  $\x/\y$` . If used, this key should be used before the other keys.

`/pgf/foreach/evaluate= $\langle variable \rangle$  as  $\langle macro \rangle$  using  $\langle formula \rangle$`  (no default)

By default list items are not evaluated: `1+2`, yields `1+2`, not `3`. This key allows a variable to be evaluated using the mathematical engine. The variable must have been specified either using the `var` key or in the  $\langle variables \rangle$  argument of the `foreach` command. By default, the result of the evaluation will be stored in  $\langle variable \rangle$ . However, the optional `as  $\langle macro \rangle$`  statement can be used to store the result in  $\langle macro \rangle$ .

1.0, 2.0, 4.0, 8.0, 16.0, 32.0, 64.0, 128.0, 256.0,

```
\foreach \x [evaluate= $\x$ ] in {2^0,2^1,...,2^8}{ $\x$ $, }
```

$2^0 = 1.0$ ,  $2^1 = 2.0$ ,  $2^2 = 4.0$ ,  $2^3 = 8.0$ ,  $2^4 = 16.0$ ,  $2^5 = 32.0$ ,  $2^6 = 64.0$ ,  $2^7 = 128.0$ ,  $2^8 = 256.0$ ,

```
\foreach \x [evaluate= $\x$  as  $\xeval$ ] in {2^0,2^1,...,2^8}{ $\x$ = $\xeval$ $, }
```

The optional `using <formula>` statement means an evaluation does not have to be explicitly stated for each item in `<list>`. The `<formula>` should contain at least one reference to `<variable>`.



```
\tikz\foreach \x [evaluate=\x as \shade using \x*10] in {0,1,...,10}
  \node [fill=red!\shade!yellow, minimum size=0.65cm] at (\x,0) {\x};
```

`/pgf/foreach/remember=<variable> as <macro> (initially <value>)` (no default)

This key allows the item value stored in `<variable>` to be remembered during the next iteration, stored in `<macro>`. If a variable is evaluated, the result of this evaluation is remembered. By default the value of `<variable>` is zero for the first iteration, however, the optional `(initially <value>)` statement, allows the `<macro>` to be initially defined as `<value>`.

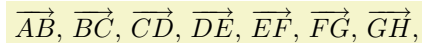

```
\foreach \x [remember=\x as \lastx (initially A)] in {B,...,H}{\overrightarrow{\lastx\x}$, }
```

`/pgf/foreach/count=<macro> from <value>` (no default)

This key allows `<macro>` to hold the position in the list of the current item. The optional `from <value>` statement allows the counting to begin from `<value>`.

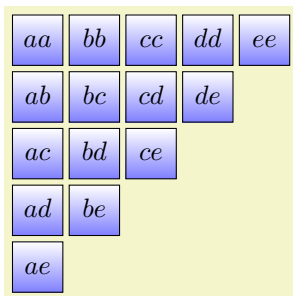

```
\tikz[x=0.75cm,y=0.75cm]
  \foreach \x [count=\xi] in {a,...,e}
    \foreach \y [count=\yi] in {\x,...,e}
      \node [draw, top color=white, bottom color=blue!50, minimum size=0.666cm]
        at (\xi,-\yi) {\mathstrut\x\y$};
```

### `\breakforeach`

If this command is given inside a `\foreach` command, no further executions of the `<commands>` will occur. However, the current execution of the `<commands>` is continued normally, so it is probably best to use this command only at the end of a `\foreach` command.

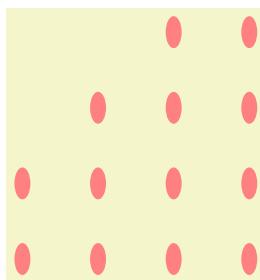

```
\begin{tikzpicture}
  \foreach \x in {1,...,4}
    \foreach \y in {1,...,4}
      {
        \fill[red!50] (\x,\y) ellipse (3pt and 6pt);

        \ifnum \x<\y
          \breakforeach
        \fi
      }
\end{tikzpicture}
```



## 57 Date and Calendar Utility Macros

This section describes the package `pgfcalendar`.

```
\usepackage{pgfcalendar} %  $\LaTeX$ 
\input pgfcalendar.tex % plain  $\TeX$ 
\usemodule[pgfcalendar] % Con $\TeX$ t
```

This package can be used independently of PGF. It has two purposes:

1. It provides functions for working with dates. Most noticeably, it can convert a date in ISO-standard format (like 1975-12-26) to a so-called Julian day number, which is defined in Wikipedia as follows: “The Julian day or Julian day number is the (integer) number of days that have elapsed since the initial epoch at noon Universal Time (UT) Monday, January 1, 4713 BC in the proleptic Julian calendar.” The package also provides a function for converting a Julian day number to an ISO-format date.

Julian day numbers make it very easy to work with days. For example, the date ten days in the future of 2008-02-20 can be computed by converting this date to a Julian day number, adding 10, and then converting it back. Also, the day of week of a given date can be computed by taking the Julian day number modulo 7.

2. It provides a macro for typesetting a calendar. This macro is highly configurable and flexible (for example, it can produce both plain text calendars and also complicated  $\TeX$ -based calendars), but most users will not use the macro directly. It is the job of a frontend to provide useful configurations for typesetting calendars based on this command.

### 57.1 Handling Dates

#### 57.1.1 Conversions Between Date Types

`\pgfcalendardatetojulian`{ $\langle date \rangle$ }{ $\langle counter \rangle$ }

This macro converts a date in a format to be described in a moment to the Julian day number in the Gregorian calendar. The  $\langle date \rangle$  should expand to a string of the following form:

1. It should start with a number representing the year. Use `\year` for the current year, that is, the year the file is being typeset.
2. The year must be followed by a hyphen.
3. Next should come a number representing the month. Use `\month` for the current month. You can, but need not, use leading zeros. For example, 02 represents February, just like 2.
4. The month must also be followed by a hyphen.
5. Next you must either provide a day of month (again, a number and, again, `\day` yields the current day of month) or the keyword `last`. This keyword refers to the last day of the month, which is automatically computed (and which is a bit tricky to compute, especially for February).
6. Optionally, you can next provide a plus sign followed by positive or negative number. This number of days will be added to the computed date.

Here are some examples:

- 2006-01-01 refers to the first day of 2006.
- 2006-02-last refers to February 28, 2006.
- `\year-\month-\day` refers to today.
- 2006-01-01+2 refers to January 3, 2006.
- `\year-\month-\day+1` refers to tomorrow.
- `\year-\month-\day+-1` refers to yesterday.

The conversion method is taken from the English Wikipedia entry on Julian days.

*Example:* `\pgfcalendardatetojulian{2007-01-14}{\mycount}` sets `\mycount` to 2454115.

`\pgfcalendarjuliantodate`{*Julian day*}{*year macro*}{*month macro*}{*day macro*}

This command converts a Julian day number to an ISO-date. The *Julian day* must be a number or  $\TeX$  counter, the *year macro*, *month macro* and *day macro* must be  $\TeX$  macro names. They will be set to numbers representing the year, month, and day of the given Julian day in the Gregorian calendar.

The *year macro* will be assigned the year without leading zeros. Note that this macro will produce year 0 (as opposed to other calendars, where year 0 does not exist). However, if you really need calendars for before the year 1, it is expected that you know what you are doing anyway.

The *month macro* gets assigned a two-digit number representing the month (with a leading zero, if necessary). Thus, the macro is set to 01 for January.

The *day macro* gets assigned a two-digit number representing the day of the month (again with a possible leading zero).

To convert a Julian day number to an ISO-date you use code like the following:

```
\pgfcalendarstatetojulian{2454115}{\myyear}{\mymonth}{\myday}
\edef\isodate{\myyear-\mymonth-\myday}
```

The above code sets `\isodate` to 2007-01-14.

`\pgfcalendarjuliantoweekday`{*Julian day*}{*week day counter*}

This command converts a Julian day to a week day by computing the day modulo 7. The *week day counter* must be a  $\TeX$  counter. It will be set to 0 for a Monday, to 1 for a Tuesday, and so on.

*Example:* `\pgfcalendarjuliantoweekday{2454115}{\mycount}` sets `\mycount` to 6.

### 57.1.2 Checking Dates

`\pgfcalendarifdate`{*date*}{*tests*}{*code*}{*else code*}

This command is used to execute code based on properties of *date*. The *date* must be a date in ISO-format. For this date, the *tests* are checked (to be detailed later) and if one of the tests applied, the *code* is executed. If none of the tests applies, the *else code* is executed.

*Example:* `\pgfcalendarifdate{2007-02-07}{Wednesday}{Is a Wednesday}{Is not a Wednesday}` yields `Is a Wednesday`.

The *tests* is a comma-separated list of key-value pairs. The following are defined by default:

- **all** This test is passed by all dates.
- **Monday** This test is passed by all dates that are Mondays.
- **Tuesday** as above.
- **Wednesday** as above.
- **Thursday** as above.
- **Friday** as above.
- **Saturday** as above.
- **Sunday** as above.
- **workday** Passed by Mondays, Tuesdays, Wednesdays, Thursdays, and Fridays.
- **weekend** Passed Saturdays and Sundays.
- **equals=*reference*** The *reference* can be in one of two forms: Either, it is a full ISO format date like 2007-01-01 or the year may be missing as in 12-31. In the first case, the test is passed if *date* is the same as *reference*. In the second case, the test is passed if the month and day part of *date* is the same as *reference*.  
For example, the test **equals=2007-01-10** will only be passed by this particular date. The test **equals=05-01** will be passed by every first of May on any year.
- **at least=*reference*** This test works similarly to the **equals** test, only it is checked whether *date* is equal to *reference* or to any later date. Again, the *reference* can be a full date like 2007-01-01 or a short version like 07-01. For example, **at least=07-01** is true for every day in the second half of any year.

- `at most=<reference>` as above.
- `between=<start reference> and <end reference>` This test checks whether the current date lies between the two given reference dates. Both full and short version may be given.  
For example `between=2007-01-01 and 2007-02-28` is true for the days in January and February of 2007.  
For another example, `between=05-01 and 05-07` is true for the days of the first week of May of any year.
- `day of month=<number>` Passed by the day of month of the  $\langle date \rangle$  is  $\langle number \rangle$ . For example, the test `day of month=1` is passed by every first of every month.
- `end of month=<number>` Passed by the day of month of the  $\langle date \rangle$  that is  $\langle number \rangle$  from the end of the month. For example, the test `end of month=1` is passed by the last day of every month, the test `end of month=2` is passed by the second last day of every month. If  $\langle number \rangle$  is omitted, it is assumed to be 1.

In addition to the above checks, you can also define new checks. To do so, you must add a new key to the key-value group `pgfcalendar` using `\define@key`. The job of the code of this new key is to possibly set the  $\TeX$ -if `\ifpgfcalendarmatches` to true (if it is already true, no action should be taken) to indicate that the  $\langle date \rangle$  passes the test setup by this new key.

In order to perform the test, the key code needs to know the date that should be checked. The date is available through a macro, but a whole bunch of additional information about this date is also available through the following macros:

- `\pgfcalendarifdatejulian` is the Julian day number of the  $\langle date \rangle$  to be checked.
- `\pgfcalendarifdateweekday` is the weekday of the  $\langle date \rangle$  to be checked.
- `\pgfcalendarifdateyear` is the year of the  $\langle date \rangle$  to be checked.
- `\pgfcalendarifdatemonth` is the month of the  $\langle date \rangle$  to be checked.
- `\pgfcalendarifdateday` is the day of month of the  $\langle date \rangle$  to be checked.

For example, let us define a new key that checks whether the  $\langle date \rangle$  is a Workers day (first of May). This can be done as follows:

```
\define@key{pgfcalendar}{workers day}[]
{
  \ifnum\pgfcalendarifdatemonth=5\relax
    \ifnum\pgfcalendarifdateday=1\relax
      \pgfcalendarmatchestrue
    \fi
  \fi
}
```

### 57.1.3 Typesetting Dates

`\pgfcalendarweekdayname{\langle week day number \rangle}`

This command expands to a textual representation of the day of week, given by the  $\langle week day number \rangle$ . Thus, `\pgfcalendarweekdayname{0}` expands to `Monday` if the current language is English and to `Montag` if the current language is German, and so on. See Section 57.1.4 for more details on translations.

*Example:* `\pgfcalendarweekdayname{2}` yields `Wednesday`.

`\pgfcalendarweekdayshortname{\langle week day number \rangle}`

This command works similarly to the previous command, only an abbreviated version of the week day is produced.

*Example:* `\pgfcalendarweekdayshortname{2}` yields `Wed`.

`\pgfcalendarmonthname{\langle month number \rangle}`

This command expands to a textual representation of the month, which is given by the  $\langle month number \rangle$ .

*Example:* `\pgfcalendarmonthname{12}` yields `December`.

`\pgfcalendarmonthshortname{<month number>}`

As above, only an abbreviated version is produced.

*Example:* `\pgfcalendarmonthshortname{12}` yields Dec.

#### 57.1.4 Localization

All textual representations of week days or months (like “Monday” or “February”) are wrapped with `\translate` commands from the `translator` package (if this package is not loaded, no translation takes place). Furthermore, the `pgfcalendar` package will try to load the `translator-months-dictionary`, if the `translator` package is loaded.

The net effect of all this is that all dates will be translated to the current language setup in the `translator` package. See the documentation of this package for more details.

## 57.2 Typesetting Calendars

`\pgfcalendar{<prefix>}{<start date>}{<end date>}{<rendering code>}`

This command can be used to typeset a calendar. It is a very general command, the actual work has to be done by giving clever implementations of *<rendering code>*. Note that this macro need *not* be called inside a `{\pgfpicture}` environment (even though it typically will be) and you can use it to typeset calendars in normal T<sub>E</sub>X or using packages other than PGF.

**Basic typesetting process.** A calendar is typeset as follows: The *<start date>* and *<end date>* specify a range of dates. For each date in this range the *<rendering code>* is executed with certain macros setup to yield information about the *current date* (the current date in the enumeration of dates of the range). Typically, the *<rendering code>* places nodes inside a picture, but it can do other things as well. Note that it is also the job of the *<rendering code>* to position the calendar correctly.

The different calls of the *<rendering code>* are not surrounded by T<sub>E</sub>X groups (though you can do so yourself, of course). This means that settings can accumulate between different calls, which is often desirable and useful.

**Information about the current date.** Inside the *<rendering code>*, different macros can be access:

- `\pgfcalendarprefix` The *<prefix>* parameter. This prefix is recommended for nodes inside the calendar, but you have to use it yourself explicitly.
- `\pgfcalendarbeginiso` The *<start date>* of range being typeset in ISO format (like 2006-01-10).
- `\pgfcalendarbeginjulian` Julian day number of *<start date>*.
- `\pgfcalendarendiso` The *<end date>* of range being typeset in ISO format.
- `\pgfcalendarendjulian` Julian day number of *<end date>*.
- `\pgfcalendarcurrentjulian` This T<sub>E</sub>X count holds the Julian day number of day currently begin rendered.
- `\pgfcalendarcurrentweekday` The weekday (a number with zero representing Monday) of the current date.
- `\pgfcalendarcurrentyear` The year of the current date.
- `\pgfcalendarcurrentmonth` The month of the current date (always two digits with a leading zero, if necessary).
- `\pgfcalendarcurrentday` The day of month of the current date (always two digits).

**The `\ifdate` command.** Inside the `\pgfcalendar` the macro `\ifdate` is available locally:

`\ifdate{<tests>}{<code>}{<else code>}`

This command has the same effect as calling `\pgfcalendarifdate` for the current date.

**Examples.** In a first example, let us create a very simple calendar: It just lists the dates in a certain range.

20 21 22 23 24 25 26 27 28 29 30 31 01 02 03 04 05 06 07 08 09 10

```
\pgfcalendar{cal}{2007-01-20}{2007-02-10}{\pgfcalendarcurrentday\ }
```

Let us now make this a little more interesting: Let us add a line break after each Sunday.

```
20 21
22 23 24 25 26 27 28
29 30 31 01 02 03 04
05 06 07 08 09 10
```

```
\pgfcalendar{cal}{2007-01-20}{2007-02-10}
{
  \pgfcalendarcurrentday\
  \ifdate{Sunday}{\par}{\par}
}
```

We now want to have all Mondays to be aligned on a column. For this, different approaches work. Here is one based positioning each day horizontally using a skip.

```
20 21
22 23 24 25 26 27 28
29 30 31 01 02 03 04
05 06 07 08 09 10
```

```
\pgfcalendar{cal}{2007-01-20}{2007-02-10}
{
  \leavevmode%
  \hbox toOpt{\hskip\pgfcalendarcurrentweekday cm\pgfcalendarcurrentday\hss}%
  \ifdate{Sunday}{\par}{\par}
}
```

Let us now typeset two complete months.

```

          January
  1   2   3   4   5   6   7
  8   9  10  11  12  13  14
 15  16  17  18  19  20  21
 22  23  24  25  26  27  28
 29  30  31

          February
                1   2   3   4
  5   6   7   8   9  10  11
 12  13  14  15  16  17  18
 19  20  21  22  23  24  25
 26  27  28
```

```
\pgfcalendar{cal}{2007-01-01}{2007-02-28}{%
  \ifdate{day of month=1}{
    \par\bigskip\hbox to7.5cm{\itshape\hss\pgfcalendarshorthand mt\hss}\par
  }{}%
  \leavevmode%
  {%
    \ifdate{weekend}{\color{black!50}}{\color{black}}%
    \hbox to0pt{%
      \hskip\pgfcalendarcurrentweekday cm%
      \hbox to1cm{\hss\pgfcalendarshorthand d-}\hss%
    }%
  }%
  \ifdate{Sunday}{\par}{\par}%
}
```

For our final example, we use a `{tikzpicture}`.

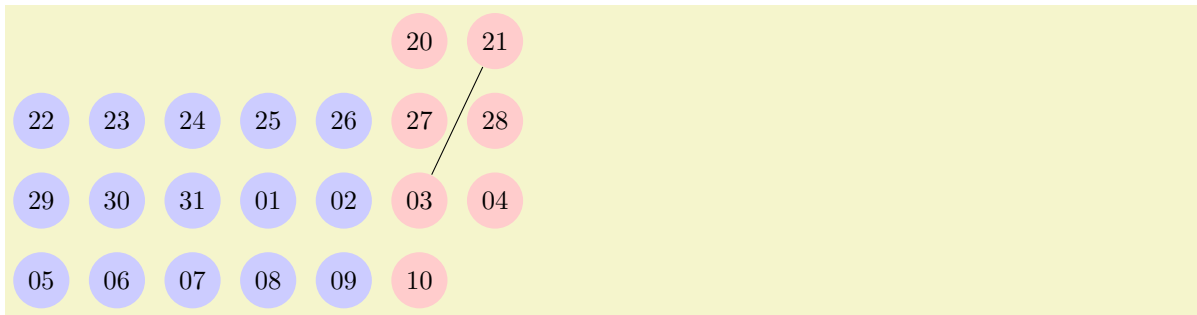

```

\begin{tikzpicture}
  \pgfcalendar{cal}{2007-01-20}{2007-02-10}{%
    \ifdate{workday}
      {\tikzset{filling/.style={fill=blue!20}}}
      {\tikzset{filling/.style={fill=red!20}}}
    \node (\pgfcalendarsuggestedname) at (\pgfcalendarcurrentweekday,0)
      [anchor=base,circle,filling] {\pgfcalendarcurrentday};
    \ifdate{Sunday}{\pgftransformmyshift{-3em}}{}%
  }
  \draw (cal-2007-01-21) -- (cal-2007-02-03);
\end{tikzpicture}

```

**\pgfcalendarshorthand**{<kind>}{<representation>}

This command can be used inside a `\pgfcalendar`, where it will expand to a representation of the current day, month, year or day of week, depending on whether *<kind>* is *d*, *m*, *y* or *w*. The *<representation>* can be one of the following: `-`, `=`, `0`, `.`, and `t`. They have the following meanings:

- The minus sign selects the shortest numerical representation possible (no leading zeros).
- The equal sign also selects the shortest numerical representation, but a space is added to single digit days and months (thereby ensuring that they have the same length as other days).
- The zero digit selects a two-digit numerical representation for days and months. For years it is allowed, but has no effect.
- The letter `t` selects a textual representation.
- The dot selects an abbreviated textual representation.

Normally, you should say `\let\%=\pgfcalendarshorthand` locally, so that you can write `\%wt` instead of the much more cumbersome `\pgfcalendarshorthand{w}{t}`.

ISO form: 2007-01-20, long form: Saturday, January 20, 2007

```

\let\%=\pgfcalendarshorthand
\pgfcalendar{cal}{2007-01-20}{2007-01-20}
{ ISO form: \%y0-\%m0-\%d0, long form: \%wt, \%mt \%d-, \%y0}

```

**\pgfcalendarsuggestedname**

This macro expands to a suggested name for nodes representing days in a calendar. If the *<prefix>* is empty, it expands to the empty string, otherwise it expands to the *<prefix>* of the calendar, followed by a hyphen, followed by the ISO format version of the date. Thus, when the date 2007-01-01 is typeset in a calendar for the prefix `mycal`, the macro expands to `mycal-2007-01-01`.

## 58 Page Management

This section describes the `pgfpages` packages. Although this package is not concerned with creating pictures, its implementation relies so heavily on PGF that it is documented here. Currently, `pgfpages` only works with L<sup>A</sup>T<sub>E</sub>X, but if you are adventurous, feel free to hack the code so that it also works with plain T<sub>E</sub>X.

The aim of `pgfpages` is to provide a flexible way of putting multiple pages on a single page *inside* T<sub>E</sub>X. Thus, `pgfpages` is quite different from useful tools like `psnup` or `pdfnup` insofar as it creates its output in a single pass. Furthermore, it works uniformly with both `latex` and `pdflatex`, making it easy to put multiple pages on a single page without any fuss.

A word of warning: *using `pgfpages` will destroy hyperlinks*. Actually, the hyperlinks are not destroyed, only they will appear at totally wrong positions on the final output. This is due to a fundamental flaw in the PDF specification: In PDF the bounding rectangle of a hyperlink is given in “absolute page coordinates” and translations or rotations do not affect them. Thus, the transformations applied by `pgfpages` to put the pages where you want them are (cannot, even) be applied to the coordinates of hyperlinks. It is unlikely that this will change in the foreseeable future.

### 58.1 Basic Usage

The internals of `pgfpages` are complex since the package can do all sorts of interesting tricks. For this reason, so-called *layouts* are predefined that setup all option in appropriate ways.

You use a layout as follows:

```
\documentclass{article}

\usepackage{pgfpages}
\pgfpagesuselayout{2 on 1}[a4paper,landscape,border shrink=5mm]

\begin{document}
This text is shown on the left.
\clearpage
This text is shown on the right.
\end{document}
```

The layout `2 on 1` puts two pages on a single page. The option `a4paper` tells `pgfpages` that the *resulting* page (called the *physical* page in the following) should be `a4paper` and it should be `landscape` (which is quite logical since putting two portrait pages next to each other gives a landscape page). Normally, the *logical* pages, that is, the pages that T<sub>E</sub>X “thinks” that it is typesetting, will have the same sizes, but this need not be the case. `pgfpages` will automatically scale down the logical pages such that two logical pages fit next to each other inside a DIN A4 page.

The `border shrink` tells `pgfpages` that it should add an additional 5mm to the shrinking such that a 5mm-wide border is shown around the resulting logical pages.

As a second example, let us put two pages produced by the BEAMER class on a single page:

```
\documentclass{beamer}

\usepackage{pgfpages}
\pgfpagesuselayout{2 on 1}[a4paper,border shrink=5mm]

\begin{document}
\begin{frame}
  This text is shown at the top.
\end{frame}
\begin{frame}
  This text is shown at the bottom.
\end{frame}
\end{document}
```

Note that we do not use the `landscape` option since BEAMER’s logical pages are already in landscape mode and putting two landscape pages on top of each other results in a portrait page. However, if you had used the `4 on 1` layout, you would have had to add `landscape` once more, using the `8 on 1` you must not, using `16 on 1` you need it yet again. And, no, there is no `32 on 1` layout.

Another word of caution: *using `pgfpages` will produce wrong page numbers in the `.aux` file*. The reason is that T<sub>E</sub>X instantiates the page numbers when writing an `.aux` file only when the physical page is shipped out. Fortunately, this problem is easy to fix: First, typeset our file normally without using the `\pgfpagesuselayout` command (just put the comment marker `%` before it) Then, rerun T<sub>E</sub>X with the



`\pgfpagesuselayout` command included and add the command `\nofiles`. This command ensures that the `.aux` file is not modified, which is exactly what you want. So, to typeset the above example, you should actually first  $\TeX$  the following file:

```
\documentclass{article}

\usepackage{pgfpages}
%%\pgfpagesuselayout{2 on 1}[a4paper,landscape,border shrink=5mm]
%%\nofiles

\begin{document}
This text is shown on the left.
\clearpage
This text is shown on the right.
\end{document}
```

and then typeset

```
\documentclass{article}

\usepackage{pgfpages}
\pgfpagesuselayout{2 on 1}[a4paper,landscape,border shrink=5mm]
\nofiles

\begin{document}
This text is shown on the left.
\clearpage
This text is shown on the right.
\end{document}
```

The final basic example is the `resize to` layout (it works a bit like a hypothetical `1 on 1` layout). This layout resizes the logical page such that it fits the specified physical size. Since this does not change the page numbering, you need not worry about the `.aux` files with this layout. For example, adding the following lines will ensure that the physical output will fit on DIN A4 paper:

```
\usepackage{pgfpages}
\pgfpagesuselayout{resize to}[a4paper]
```

This can be very useful when you have to handle lots of papers that are typeset for, say, letter paper and you have an A4 printer or the other way round. For example, the following article will be fit for printing on letter paper:

```
\documentclass[a4paper]{article}
%% a4 is currently the logical size and also the physical size

\usepackage{pgfpages}
\pgfpagesuselayout{resize to}[letterpaper]
%% a4 is still the logical size, but letter is the physical one

\begin{document}
  \title{My Great Article}
  ...
\end{document}
```

## 58.2 The Predefined Layouts

This section explains the predefined layouts in more detail. You select a layout using the following command:

`\pgfpagesuselayout{<layout>}[<options>]`

Installs the specified *<layout>* with the given *<options>* set. The predefined layouts and their permissible options are explained below.

If this function is called multiple times, only the last call “wins.” You can thereby overwrite any previous settings. In particular, layouts *do not* accumulate.

*Example:* `\pgfpagesuselayout{resize to}[a4paper]`

`\pgfpagesuselayout{resize to}[<options>]`

This layout is used to resize every logical page to a specified physical size. To determine the target size, the following options may be given:



- `physical paper height=<size>` sets the height of the physical page size to *<size>*.
- `physical paper width=<size>` sets the width of the physical page size to *<size>*.
- `a0paper` sets the physical page size to DIN A0 paper.
- `a1paper` sets the physical page size to DIN A1 paper.
- `a2paper` sets the physical page size to DIN A2 paper.
- `a3paper` sets the physical page size to DIN A3 paper.
- `a4paper` sets the physical page size to DIN A4 paper.
- `a5paper` sets the physical page size to DIN A5 paper.
- `a6paper` sets the physical page size to DIN A6 paper.
- `letterpaper` sets the physical page size to the American letter paper size.
- `legalpaper` sets the physical page size to the American legal paper size.
- `executivepaper` sets the physical page size to the American executive paper size.
- `landscape` swaps the height and the width of the physical paper.
- `border shrink=<size>` additionally reduces the size of the logical page on the physical page by *<size>*.

`\pgfpagesuselayout{2 on 1}[<options>]`

Puts two logical pages alongside each other on each physical page if the logical height is larger than the logical width (logical pages are in portrait mode). Otherwise, two logical pages are put on top of each other (logical pages are in landscape mode). When using this layout, it is advisable to use the `\nofiles` command, but this is not done automatically.

The same *<options>* as for the `resize to` layout can be used, plus the following option:

- `odd numbered pages right` places the first page on the right.

`\pgfpagesuselayout{4 on 1}[<options>]`

Puts four logical pages on a single physical page. The same *<options>* as for the `resize to` layout can be used.

`\pgfpagesuselayout{8 on 1}[<options>]`

Puts eight logical pages on a single physical page. As for `2 on 1`, the orientation depends on whether the logical pages are in landscape mode or in portrait mode.

`\pgfpagesuselayout{16 on 1}[<options>]`

This is for the CEO.

`\pgfpagesuselayout{rounded corners}[<options>]`

This layout adds “rounded corners” to every page, which, supposedly, looks nicer during presentations with projectors (personally, I doubt this). This is done by (possibly) resizing the page to the physical page size. Then four black rectangles are drawn in each corner. Next, a clipping region is set up that contains all of the logical page except for little rounded corners. Finally, the logical page is drawn, clipped against the clipping region.

Note that every logical page should fill its background for this to work.

In addition to the *<options>* that can be given to `resize to` the following options may be given.

- `corner width=<size>` specifies the size of the corner.

```
\documentclass{beamer}
\usepackage{pgfpages}
\pgfpagesuselayout{rounded corners}[corner width=5pt]
\begin{document}
...
\end{document}
```

`\pgfpagesuselayout{two screens with lagging second}[\langle options \rangle]`

This layout puts two logical pages alongside each other. The second page always shows what the main page showed on the previous physical page. Thus, the second page “lags behind” the main page. This can be useful when you have to projectors attached to your computer and can show different parts of a physical page on different projectors.

The following  $\langle options \rangle$  may be given:

- **second right** puts the second page right of the main page. This will make the physical pages twice as wide as the logical pages, but it will retain the height.
- **second left** puts the second page left, otherwise it behave the same as **second right**.
- **second bottom** puts the second page below the main page. This make the physical pages twice as high as the logical ones.
- **second top** works like **second bottom**.

`\pgfpagesuselayout{two screens with optional second}[\langle options \rangle]`

This layout works similarly to **two screens with lagging second**. The difference is that the contents of the second screen only changes when one of the commands `\pgfshipoutlogicalpage{2}{\langle box \rangle}` or `\pgfcurrentpagewillbelogicalpage{2}` is called. The first puts the given  $\langle box \rangle$  on the second page. The second specifies that the current page should be put there, once it is finished.

The same options as for **two screens with lagging second** may be given.

You can define your own predefined layouts using the following command:

`\pgfpagesdeclarelayout{\langle layout \rangle}{\langle before actions \rangle}{\langle after actions \rangle}`

This command predefines a  $\langle layout \rangle$  that can later be installed using the `\pgfpagesuselayout` command.

When `\pgfpagesuselayout{\langle layout \rangle}[\langle options \rangle]` is called, the following happens: First, the  $\langle before actions \rangle$  are executed. They can be used, for example, to setup default values for keys. Next, `\setkeys{pgfpagesuselayoutoption}{\langle options \rangle}` is executed. Finally, the  $\langle after actions \rangle$  are executed.

Here is an example:

```
\pgfpagesdeclarelayout{resize to}
{
  \def\pgfpageoptionborder{0pt}
}
{
  \pgfpagesphysicalpageoptions
  {%
    logical pages=1,%
    physical height=\pgfpageoptionheight,%
    physical width=\pgfpageoptionwidth%
  }
  \pgfpageslogicalpageoptions{1}
  {%
    resized width=\pgfphysicalwidth,%
    resized height=\pgfphysicalheight,%
    border shrink=\pgfpageoptionborder,%
    center=\pgfpoint{.5\pgfphysicalwidth}{.5\pgfphysicalheight}%
  }%
}
```

### 58.3 Defining a Layout

If none of the predefined layouts meets your problem or if you wish to modify them, you can create layouts from scratch. This section explains how this is done.

Basically, `pgfpages` hooks into  $\text{T}_{\text{E}}\text{X}$ 's `\shipout` function. This function is called whenever  $\text{T}_{\text{E}}\text{X}$  has completed typesetting a page and wishes to send this page to the `.dvi` or `.pdf` file. The `pgfpages` package redefines this command. Instead of sending the page to the output file, `pgfpages` stores it in an internal box and then acts as if the page had been output. When  $\text{T}_{\text{E}}\text{X}$  tries to output the next page using `\shipout`, this call is once more intercepted and the page is stored in another box. These boxes are called *logical pages*.

At some point, enough logical pages have been accumulated such that a *physical page* can be output. When this happens, `pgfpages` possibly scales, rotates, and translates the logical pages (and possibly even does further modifications) and then puts them at certain positions of the *physical* page. Once this page is fully assembled, the “real” or “original” `\shipout` is called to send the physical page to the output file.

In reality, things are slightly more complicated. First, once a physical page has been shipped out, the logical pages are usually voided, but this need not be the case. Instead, it is possible that certain logical page just retain their contents after the physical page has been shipped out and these pages need not be filled once more before a physical shipout can occur. However, the contents of these logical pages can still be changed using special commands. It is also possible that after a shipout certain logical pages are filled with the contents of *other* logical pages.

A *layout* defines for each logical page where it will go on the physical page and which further modifications should be done. The following two commands are used to define the layout:

`\pgfpagesphysicalpageoptions{⟨options⟩}`

This command sets the characteristic of the “physical” page. For example, it is used to specify how many logical pages there are and how many logical pages must be accumulated before a physical page is shipped out. How each individual logical page is typeset is specified using the command `\pgfpageslogicalpageoptions`, described later.

*Example:* A layout for putting two portrait pages on a single landscape page:

```
\pgfpagesphysicalpageoptions
{
  logical pages=2,%
  physical height=\paperwidth,%
  physical width=\paperheight,%
}

\pgfpageslogicalpageoptions{1}
{
  resized width=.5\pgfphysicalwidth,%
  resized height=\pgfphysicalheight,%
  center=\pgfpoint{.25\pgfphysicalwidth}{.5\pgfphysicalheight}%
}%

\pgfpageslogicalpageoptions{2}
{
  resized width=.5\pgfphysicalwidth,%
  resized height=\pgfphysicalheight,%
  center=\pgfpoint{.75\pgfphysicalwidth}{.5\pgfphysicalheight}%
}%
```

The following *⟨options⟩* may be set:

- **logical pages=⟨logical pages⟩** specified how many logical pages there are, in total. These are numbered 1 to *⟨logical pages⟩*.
- **first logical shipout=⟨first⟩**. See the the next option. By default, *⟨first⟩* is 1.
- **last logical shipout=⟨last⟩**. Together with the previous option, these two options define an interval of pages inside the range 1 to *⟨logical pages⟩*. Only this range is used to store the pages that are shipped out by  $\TeX$ . This means that after a physical shipout has just occurred (or at the beginning), the first time  $\TeX$  wishes to perform a shipout, the page to be shipped out is stored in logical page *⟨first⟩*. The next time  $\TeX$  performs a shipout, the page is stored in logical page *⟨first⟩* + 1 and so on, until the logical page *⟨last⟩* is also filled. Once this happens, a physical shipout occurs and the process starts once more.

Note that logical pages that lie outside the interval between *⟨first⟩* and *⟨last⟩* are filled only indirectly or when special commands are used.

By default, *⟨last⟩* equals *⟨logical pages⟩*.

- **current logical shipout=⟨current⟩** changes an internal counter such that  $\TeX$ 's next logical shipout will be stored in logical page *⟨current⟩*.

This option can be used to “warp” the logical page filling mechanism to a certain page. You can both skip logical pages and overwrite already filled logical pages. After the logical page *⟨current⟩* has been filled, the internal counter is incremented normally as if the logical page *⟨current⟩* had been “reached” normally. If you specify a *⟨current⟩* larger to *⟨last⟩*, a physical shipout will occur after the logical page *⟨current⟩* has been filled.

- **physical height**=*(height)* specifies the height of the physical pages. This height is typically different from the normal `\paperheight`, which is used by  $\TeX$  for its typesetting and page breaking purposes.
- **physical width**=*(width)* specifies the physical width.

`\pgfpageslogicalpageoptions{<logical page number>}{<options>}`

This command is used to specify where the logical page number *<logical page number>* will be placed on the physical page. In addition, this command can be used to install additional “code” to be executed when this page is put on the physical page.

The number *<logical page number>* should be between 1 and *<logical pages>*, which has previously been installed using the `\pgfpagesphysicalpageoptions` command.

The following *<options>* may be given:

- **center**=*(pgf point)* specifies the center of the logical page inside the physical page as a PGF-point. The origin of the coordinate system of the physical page is at the *lower* left corner.

```
\pgfpageslogicalpageoptions{1}
{% center logical page on middle of left side
  center=\pgfpoint{.25\pgfphysicalwidth}{.5\pgfphysicalheight}%
  resized width=.5\pgfphysicalwidth,%
  resized height=\pgfphysicalheight,%
}
```

- **resized width**=*(size)* specifies the width that the logical page should have *at most* on the physical page. To achieve this width, the pages is scaled down appropriately *or more*. The “or more” part can happen if the **resize height** option is also used. In this case, the scaling is chosen such that both the specified height and width are met. The aspect ratio of a logical page is not modified.
- **resized height**=*(height)* specifies the maximum height of the logical page.
- **original width**=*(width)* specifies the width the  $\TeX$  “thinks” that the logical page has. This width is `\paperwidth` at the point of invocation, by default. Note that setting this width to something different from `\paperwidth` does *not* change the `\pagewidth` during  $\TeX$ ’s typesetting. You have to do that yourself.

You need this option only for special logical pages that have a height or width different from the normal one and for which you will (later on) set these sizes yourself.

- **original height**=*(height)* works like **original width**.
- **scale**=*(factor)* scales the page by at least the given *<factor>*. A *<factor>* of 0.5 will half the size of the page, a factor of 2 will double the size. “At least” means that if options like **resize height** are given and if the scaling required to meet that option is less than *<factor>*, that other scaling is used instead.
- **xscale**=*(factor)* scales the logical page along the *x*-axis by the given *<factor>*. This scaling is done independently of any other scaling. Mostly, this option is useful for a factor of -1, which flips the page along the *y*-axis. The aspect ratio is not kept.
- **yscale**=*(factor)* works like **xscale**, only for the *y*-axis.
- **rotation**=*(degree)* rotates the page by *<degree>* around its center. Use a degree of 90 or -90 to go from portrait to landscape and back. The rotation need not be a multiple of 90.
- **copy from**=*(logical page number)*. Normally, after a physical shipout has occurred, all logical pages are voided in a loop. However, if this option is given, the current logical page is filled with the contents of the old logical page number *<logical page number>*.

*Example:* Have logical page 2 retain its contents:

```
\pgfpageslogicalpageoptions{2}{copy from=2}
```

*Example:* Let logical page 2 show what logical page 1 showed on the just-shipped-out physical page:

```
\pgfpageslogicalpageoptions{2}{copy from=1}
```

- `border shrink=<size>` specifies an additional reduction of the size to which the page is scaled down.
- `border code=<code>`. When this option is given, the `<code>` is executed before the page box is inserted with a path preinstalled that is a rectangle around the current logical page. Thus, setting `<code>` to `\pgfstroke` draws a rectangle around the logical page. Setting `<code>` to `\pgfsetlinewidth{3pt}\pgfstroke` results in a thick (ugly) frame. Adding dashes and filling can result in arbitrarily funky and distracting borders.

You can also call `\pgfdiscardpath` and add your own path construction code (for example to paint a rectangle with rounded corners). The coordinate system is setup in such a way that a rectangle starting at the origin and having the height and width of T<sub>E</sub>X-box 0 will result in a rectangle filling exactly the logical page currently being put on the physical page. The logical page is inserted *after* these commands have been executed.

*Example:* Add a rectangle around the page:

```
\pgfpageslogicalpageoptions{1}{border code=\pgfstroke}
```

- `corner width=<size>` adds black “rounded corners” to the page. See the description of the predefined layout `rounded corners` on page 513.

## 58.4 Creating Logical Pages

Logical pages are created whenever a T<sub>E</sub>X thinks that a page is full and performs a `\shipout` command. This will cause `pgfpages` to store the box that was supposed to be shipped out internally until enough logical pages have been collected such that a physical shipout can occur.

Normally, whenever a logical shipout occurs that current page is stored in logical page number `<current logical page>`. This counter is then incremented, until it is larger than `<last logical shipout>`. You can, however, directly change the value of `<current logical page>` by calling `\pgfpagesphysicalpageoptions`.

Another way to set the contents of a logical page is to use the following command:

```
\pgfpagesshipoutlogicalpage{<number>}{<box>
```

This command sets to logical page `<number>` to `<box>`. The `<box>` should be the code of a T<sub>E</sub>X box command. This command does not influence the counter `<current logical page>` and does not cause a physical shipout.

```
\pgfpagesshipoutlogicalpage{0}\vbox{Hi!}
```

This command can be used to set the contents of logical pages that are normally not filled.

The final way of setting a logical page is using the following command:

```
\pgfpagescurrentpagewillbelogicalpage{<number>}
```

When the current T<sub>E</sub>X page has been typeset, it will become the given logical page `<number>`. This command “interrupts” the normal order of logical pages, that is, it behaves like the previous command and does not update the `<current logical page>` counter.

```
\pgfpagesuselayout{two screens with optional second}
...
Text for main page.
\clearpage

\pgfpagescurrentpagewillbelogicalpage{2}
Text that goes to second page
\clearpage

Text for main page.
```

## 59 Extended Color Support

This section documents the package `xxcolor`, which is currently distributed as part of PGF. This package extends the `xcolor` package, written by Uwe Kern, which in turn extends the `color` package. I hope that the commands in `xxcolor` will some day migrate to `xcolor`, such that this package becomes superfluous.

The main aim of the `xxcolor` package is to provide an environment inside which all colors are “washed out” or “dimmed.” This is useful in numerous situations and must typically be achieved in a roundabout manner if such an environment is not available.

```
\begin{colormixin}{mix-in specification}
  environment contents
\end{colormixin}
```

The mix-in specification is applied to all colors inside the environment. At the beginning of the environment, the mix-in is applied to the current color, i. e., the color that was in effect before the environment started. A mix-in specification is a number between 0 and 100 followed by an exclamation mark and a color name. When a `\color` command is encountered inside a mix-in environment, the number states what percentage of the desired color should be used. The rest is “filled up” with the color given in the mix-in specification. Thus, a mix-in specification like `90!blue` will mix in 10% of blue into everything, whereas `25!white` will make everything nearly white.

Red text, washed-out  
red text, washed-out  
blue text, dark  
washed-out blue text,  
dark washed-out green  
text, back to  
washed-out blue  
text, and back to red.

```
\begin{minipage}{3.5cm}\raggedright
\color{red}Red text,%
\begin{colormixin}{25!white}
  washed-out red text,
  \color{blue} washed-out blue text,
  \begin{colormixin}{25!black}
    dark washed-out blue text,
    \color{green} dark washed-out green text,%
  \end{colormixin}
  back to washed-out blue text,%
\end{colormixin}
and back to red.
\end{minipage}%
```

Note that the environment only changes colors that have been installed using the standard L<sup>A</sup>T<sub>E</sub>X `\color` command. In particular, the colors in images are not changed. There is, however, some support offered by the commands `\pgfuseimage` and `\pgfuseshading`. If the first command is invoked inside a `colormixin` environment with the parameter, say, `50!black` on an image with the name `foo`, the command will first check whether there is also a defined image with the name `foo.!50!black`. If so, this image is used instead. This allows you to provide a different image for this case. If you nest `colormixin` environments, the different mix-ins are all appended. For example, inside the inner environment of the above example, `\pgfuseimage{foo}` would first check whether there exists an image named `foo.!50!white!25!black`.

`\colorcurrentmixin`

Expands to the current accumulated mix-in. Each nesting of a `colormixin` adds a mix-in to this list.

```
!75!white should be “!75!white”
!75!black!75!white should be “!75!black!75!white”
!50!white!75!black!75!white should be “!50!white!75!black!75!white”
\begin{minipage}{\linewidth-6pt}\raggedright
\begin{colormixin}{75!white}
  \colorcurrentmixin\ should be “!75!white”\par
  \begin{colormixin}{75!black}
    \colorcurrentmixin\ should be “!75!black!75!white”\par
    \begin{colormixin}{50!white}
      \colorcurrentmixin\ should be “!50!white!75!black!75!white”\par
    \end{colormixin}
  \end{colormixin}
\end{colormixin}
\end{minipage}
```



## 60 Parser Module

```
\usepgfmodule{parser} %  $\TeX$  and plain  $\TeX$  and pure pgf
\usepgfmodule[parser] % Con $\TeX$ t and pure pgf
```

This module defines some commands for creating a simple letter-by-letter parser.

This module provides commands for defining a parser that scans some given text letter-by-letter. For each letter, some code is executed and, possible, a state-switch occurs. The parsing process ends when a final state has been reached.

**`\pgfparserparse`**{*parser name*}{*text*}

This command is used to parse the *text* using the (previously defined) parser named *parser name*.

The *text* is not contained in curly braces, rather it is all the text that follows. The end of the text is determined implicitly, namely when the final state of the parser has been reached.

The parser works as follows: At any moment, it is in a certain *state*, initially this state is called **initial**. Then, the first letter of the *text* is examined (using the `\futurelet` command). For each possible state and each possible letter, some action code is stored in the parser in a table. This code is then executed. This code may, but need not, trigger a *state switch*, causing a new state to be set. The parser then moves on to the next character of the text and repeats the whole procedure, unless it is in the state **final**, which causes the parsing process to stop immediately.

In the following example, the parser counts the number of a's in the text, ignoring any b's. The *text* ends with the first c.

```
cccThere are 9 a's.
\newcount\mycount
\pgfparserdef{myparser}{initial}{the letter a}
{\advance\mycount by 1\relax}
\pgfparserdef{myparser}{initial}{the letter b}
{} % do nothing
\pgfparserdef{myparser}{initial}{the letter c}
{\pgfparserswitch{final}}% done!

\pgfparserparse{myparser}aabaabababbbbababcccc
There are \the\mycount a's.
```

**`\pgfparserdef`**{*parser name*}{*state*}{*symbol meaning*}{*action*}

This command should be used repeatedly to define a parser named *parser name*. With a call to this command you specify that the *parser name* should do the following: When it is in state *state* and reads the letter *symbol meaning*, perform the code stored in *action*.

The *symbol meaning* must be the text that results from applying the  $\TeX$  command `\meaning` to the given character. For instance, `\meaning a` yields **the letter a**, while `\meaning 1` yields **the character 1**. A space yields **blank space**.

Inside the *action* you can perform almost any kind of code. This code will not be surrounded by a scope, so its effect persists after the parsing is done. However, each time after the *action* is executed, control goes back to the parser. You should not launch a parser inside the *action* code, unless you put it in a scope.

When you set the *state* to **all**, the state *action* is performed in all states as a fallback, whenever *symbol meaning* is encountered. This means that when you do not specify anything explicitly for a state and a letter, but you do specify something for **all** and this letter, then the specified *action* will be used.

When the parser encounters a letter for which nothing is specified in the current state (neither directly nor indirectly via **all**), an error occurs.

**`\pgfparserswitch`**{*state*}

This command can be called inside the action code of a parser to cause a state switch to *state*.

## Part VII

# Mathematical and Object-Oriented Engines

by Mark Wibrow and Till Tantau

PGF comes with two useful engines: One for doing mathematics, one for doing object-oriented programming. Both engines can be used independently of the main PGF.

The job of the mathematical engine is to support mathematical operations like addition, subtraction, multiplication and division, using both integers and non-integers, but also functions such as square-roots, sine, cosine, and generate pseudo-random numbers. Mostly, you will use the mathematical facilities of PGF indirectly, namely when you write a coordinate like  $(5\text{cm}*3, 6\text{cm}/4)$ , but the mathematical engine can also be used independently of PGF and TikZ.

The job of the object-oriented engine is to support simple object-oriented programming in  $\text{T}_{\text{E}}\text{X}$ . It allows the definition of *classes* (without inheritance), *methods*, *attributes* and *objects*.

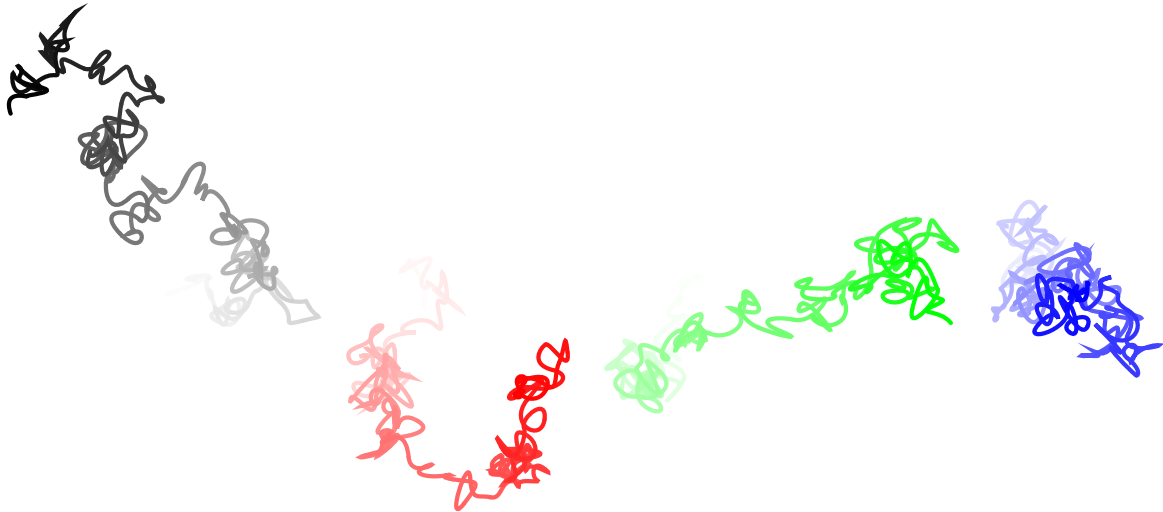

```
\pgfmathsetseed{1}
\foreach \col in {black,red,green,blue}
{
  \begin{tikzpicture}[x=10pt,y=10pt,ultra thick,baseline,line cap=round]
    \coordinate (current point) at (0,0);
    \coordinate (old velocity) at (0,0);
    \coordinate (new velocity) at (rand,rand);

    \foreach \i in {0,1,...,100}
    {
      \draw[\col!\i] (current point)
        .. controls ++([scale=-1]old velocity) and
          ++(new velocity) .. ++(rand,rand)
        coordinate (current point);
      \coordinate (old velocity) at (new velocity);
      \coordinate (new velocity) at (rand,rand);
    }
  \end{tikzpicture}
}
```



## 61 Design Principles

PGF needs to perform many computations while typesetting a picture. For this, PGF relies on a mathematical engine, which can also be used independently of PGF, but which is distributed as part of the PGF package nevertheless. Basically, the engine provides a parsing mechanism similar to the `CALC` package so that expressions like `2*3cm+5cm` can be parsed; but the PGF engine is more powerful and can be extended and enhanced.

PGF provides enhanced functionality, which permits the parsing of mathematical operations involving integers and non-integers with or without units. Furthermore, various functions, including trigonometric functions and random number generators can also be parsed (see Section 62.1). The `CALC` macros `\setlength` and friends have PGF versions which can parse these operations and functions (see Section 62.1). Additionally, each operation and function has an independent PGF command associated with it (see Section 64), and can be accessed outside the parser.

The mathematical engine of PGF is implicitly used whenever you specify a number or dimension in a higher-level macro. For instance, you can write `\pgfpoint{2cm+4cm/2}{3cm*sin(30)}` or suchlike. However, the mathematical engine can also be used independently of the PGF core, that is, you can also just load it to get access to a mathematical parser.

### 61.1 Loading the Mathematical Engine

The mathematical engine of PGF is loaded automatically by PGF, but if you wish to use the mathematical engine but you do not need PGF itself, you can load the following package:

```
\usepackage{pgfmath} %  $\TeX$ 
\input pgfmath.tex   % plain  $\TeX$ 
\usemodule{pgfmath} % Con $\TeX$ t
```

This command will load the mathematical engine of PGF, but not PGF itself. It defines commands like `\pgfmathparse`.

### 61.2 Layers of the Mathematical Engine

Like PGF itself, the mathematical engine is also structured into different layers:

1. The top layer, which you will typically use directly, provides the command `\pgfmathparse`. This command parses a mathematical expression and evaluates it.  
Additionally, the top layer also defines some additional functions similar to the macros of the `calc` package for setting dimensions and counters. These macros are just wrappers around the `\pgfmathparse` macro.
2. The calculation layer provides macros for performing one specific computation like computing a reciprocal or a multiplication. The parser uses these macros for the actual computation.
3. The implementation layer provides the actual implementations of the computations. These can be changed (and possibly be made more efficient) without affecting the higher layers.

### 61.3 Efficiency and Accuracy of the Mathematical Engine

Currently, the mathematical algorithms are all implemented in  $\TeX$ . This poses some intriguing programming challenges as  $\TeX$  is a language for typesetting, rather than for general mathematics, and as with any programming language, there is a trade-off between accuracy and efficiency. If you find the level of accuracy insufficient for your purposes, you will have to replace the algorithms in the implementation layer.

All the fancy mathematical “bells-and-whistles” that the parser provides, come with an additional processing cost, and in some instances, such as simply setting a length to `1cm`, with no other operations involved, the additional processing time is undesirable. To overcome this, the following feature is implemented: when no mathematical operations are required, an expression can be preceded by `+`. This will bypass the parsing process and the assignment will be orders of magnitude faster. This feature *only* works with the macros for setting registers described in Section 62.1.

```
\pgfmathsetlength\mydimen{1cm} % parsed      : slower.
\pgfmathsetlength\mydimen{+1cm} % not parsed : much faster.
```

## 62 Evaluating Mathematical Expressions

The easiest way of using PGF's mathematical engine is to provide a mathematical expression given in familiar infix notation, for example, `1cm+4*2cm/5.5` or `2*3+3*sin(30)`. This expression can be parsed by the mathematical engine and the result be placed in a dimension register, a counter, or a macro.

It should be noted that all calculations must not exceed  $\pm 16383.99999$  at *any* point, because the underlying computations rely on T<sub>E</sub>X dimensions. This means that many of the underlying computations are necessarily approximate and that in addition, are not very fast. T<sub>E</sub>X is, after all, a typesetting language and not ideally suited to relatively advanced mathematical operations. However, it is possible to change the computations as described in Section 65.

In the present section, the high-level macros for parsing an expression are explained first, then the syntax for expression is explained.

### 62.1 Commands for Parsing Expressions

The basic command for invoking the parser of PGF's mathematical engine is the following:

`\pgfmathparse{⟨expression⟩}`

This macro parses *⟨expression⟩* and returns the result without units in the macro `\pgfmathresult`.

*Example:* `\pgfmathparse{2pt+3.5pt}` will set `\pgfmathresult` to the text 5.5.

In the following, the special properties of this command are explained. The exact syntax of mathematical expressions is explained in Section 63.

- The result stored in the macro `\pgfmathresult` is a decimal *without units*. This is true regardless of whether the *⟨expression⟩* contains any unit specification. All numbers with units are converted to points first.
- You can check whether an expression contained a unit using the T<sub>E</sub>X-if `\ifpgfmathunitsdeclared`. After a call of `\pgfmathparse` this if will be true exactly if some unit was encountered in the expression.
- The parser can recognise T<sub>E</sub>X registers and box dimensions, so `\mydimen`, `0.5\mydimen`, `\wd\mybox`, `0.5\dp\mybox`, `\mycount\mydimen` and so on can be parsed.
- Parenthesis can be used to change the order of the evaluation.
- Various functions are recognized, so it is possible to parse `sin(.5*pi r)*60`, which means “the sine of 0.5 times  $\pi$  radians, multiplied by 60”. The argument of functions can be any expression.
- Scientific notation in the form `1.234e+4` is recognised (but the restriction on the range of values still applies). The exponent symbol can be upper or lower case (i.e., **E** or **e**).
- An integer with a zero-prefix (excluding, of course zero itself), is interpreted as an octal number and is automatically converted to base 10.
- An integer with prefix `0x` or `0X` is interpreted as a hexadecimal number and is automatically converted to base 10. Alphabetic digits can be in uppercase or lowercase.
- An integer with prefix `0b` or `0B` is interpreted as a binary number and is automatically converted to base 10.
- An expression (or part of an expression) surrounded with double quotes (i.e., the character `"`) will not be evaluated. Obviously this should be used with great care.

`\pgfmathqparse{⟨expression⟩}`

This macro is similar to `\pgfmathparse`: it parses *⟨expression⟩* and returns the result in the macro `\pgfmathresult`. It differs in two respects. Firstly, `\pgfmathqparse` does not parse functions, scientific notation, the prefixes for binary octal, or hexadecimal numbers, nor does it accept the special use of `"`, `?` or `:` characters. Secondly, numbers in *⟨expression⟩* *must* specify a T<sub>E</sub>X unit (except in such instances as `0.5\pgf@x`), which greatly simplifies the problem of parsing real numbers. As a result of these restrictions `\pgfmathqparse` is about twice as fast as `\pgfmathparse`. Note that the result will still be a number without units.

## `\pgfmathpostparse`

At the end of the parse this command is executed, allowing some custom action to be performed on the result of the parse. When this command is executed the macro `\pgfmathresult` will hold the result of the parse (as ever, without units). The result of the custom action should be to redefine `\pgfmathresult` appropriately. By default, this command is equivalent to `\relax`. This differs from previous versions, where, if the parsed expression contained no units, the result of the parse was scaled according to the value in `\pgfmathresultunitscale` (which by default was 1).

This scaling can be turned on again using: `\let\pgfmathpostparse=\pgfmathscaleresult`. Note, however that by scaling the result, the base conversion functions will not work, and the " character should not be used to quote parts of an expression.

Instead of the `\pgfmathparse` macro you can also wrapper commands, whose usage is very similar to their cousins in the `CALC` package. The only difference is that the expressions can be any expression that is handled by `\pgfmathparse`. For all of the following commands, if  $\langle expression \rangle$  starts with +, no parsing is done and a simple assignment or increment is done using normal `TEX` assignments or increments. This will be orders of magnitude faster than calling the parser.

`\pgfmathsetlength` $\{\langle dimension register \rangle\}\{\langle expression \rangle\}$

Sets the length of the `TEX`  $\langle dimension register \rangle$ , to the value (in points) specified by  $\langle expression \rangle$ . The  $\langle expression \rangle$  will be parsed using `\pgfmathparse`.

`\pgfmathaddtolength` $\{\langle dimension register \rangle\}\{\langle expression \rangle\}$

Adds the value (in points) of  $\langle expression \rangle$  to the `TEX`  $\langle dimension register \rangle$ .

`\pgfmathsetcount` $\{\langle count register \rangle\}\{\langle expression \rangle\}$

Sets the value of the `TEX`  $\langle count register \rangle$ , to the *truncated* value specified by  $\langle expression \rangle$ .

`\pgfmathaddtocount` $\{\langle count register \rangle\}\{\langle expression \rangle\}$

Adds the *truncated* value of  $\langle expression \rangle$  to the `TEX`  $\langle count register \rangle$ .

`\pgfmathsetcounter` $\{\langle counter \rangle\}\{\langle expression \rangle\}$

Sets the value of the `LATEX`  $\langle counter \rangle$ , to the *truncated* value specified by  $\langle expression \rangle$ .

`\pgfmathaddtocounter` $\{\langle counter \rangle\}\{\langle expression \rangle\}$

Adds the *truncated* value of  $\langle expression \rangle$  to  $\langle counter \rangle$ .

`\pgfmathsetmacro` $\{\langle macro \rangle\}\{\langle expression \rangle\}$

Defines  $\langle macro \rangle$  as the value of  $\langle expression \rangle$ . The result is a decimal without units.

`\pgfmathsetlengthmacro` $\{\langle macro \rangle\}\{\langle expression \rangle\}$

Defines  $\langle macro \rangle$  as the value of  $\langle expression \rangle$  `LATEX` in points.

`\pgfmathtruncatemacro` $\{\langle macro \rangle\}\{\langle expression \rangle\}$

Defines  $\langle macro \rangle$  as the *truncated* value of  $\langle expression \rangle$ .

## 63 Syntax for mathematical expressions

The syntax for the expressions recognized by `\pgfmathparse` and friends is straightforward, and the following sections describe the operators and functions that are recognized by default.

### 63.1 Operators

The following operators (presented in the context in which they are used) are recognised:

$x + y$  (infix operator; uses the `add` function)  
Adds  $x$  to  $y$ .

$x - y$  (infix operator; uses the `subtract` function)  
Subtracts  $y$  from  $x$ .

$-x$  (prefix operator; uses the `neg` function)  
Reverses the sign of  $x$ .

$x * y$  (infix operator; uses the `multiply` function)  
Multiplies  $x$  by  $y$ .

$x / y$  (infix operator; uses the `divide` function)  
Divides  $x$  by  $y$ . An error will result if  $y$  is 0, or if the result of the division is too big for the mathematical engine. Please remember when using this command that accurate (and reasonably quick) division of real numbers that are not integers is particularly tricky in `TEX`.

$x ^ y$  (infix operator; uses the `pow` function)  
Raises  $x$  to the power  $y$ .

$x!$  (postfix operator; uses the `factorial` function)  
Calculates the factorial of  $x$ .

$x\mathbf{r}$  (postfix operator; uses the `deg` function)  
Converts  $x$  to degrees ( $x$  is assumed to be in radians). This operator has the same precedence as multiplication.

$x \mathbf{?} y \mathbf{:} z$  (conditional operators; use the `ifthenelse` function)  
`?` and `:` are special operators which can be used as a shorthand for `if  $x$  then  $y$  else  $z$`  inside the parser. The expression  $x$  is taken to be true if it evaluates to any non-zero value.

$x == y$  (infix operator; uses the `equal` function)  
Returns 1 if  $x=y$ , 0 otherwise.

$x > y$  (infix operator; uses the `greater` function)  
Returns 1 if  $x>y$ , 0 otherwise.

$x < y$  (infix operator; uses the `less` function)  
Returns 1 if  $x<y$ , 0 otherwise.

$x != y$  (infix operator; uses the `notequal` function)  
Returns 1 if  $x\neq y$ , 0 otherwise.

$x >= y$  (infix operator; uses the `notless` function)  
Returns 1 if  $x\geq y$ , 0 otherwise.

$x <= y$  (infix operator; uses the `notgreater` function)  
Returns 1 if  $x\leq y$ , 0 otherwise.

$x \&\& y$  (infix operator; uses the `and` function)  
Returns 1 if both  $x$  and  $y$  evaluate to some non-zero value. Both arguments are evaluated.

$x || y$  (infix operator; uses the `or` function)  
Returns 1 if either  $x$  or  $y$  evaluate to some non-zero value.

$!x$  (prefix operator; uses the `not` function)  
Returns 1 if  $x$  evaluates to zero, 0 otherwise.

$(x)$  (group operators)  
These operators act in the usual way, that is, to control the order in which operators are executed, for example,  $(1+2)*3$ . This includes the grouping of arguments for functions, for example, `sin(30*10)` or `mod(72,3)` (the comma character is also treated as an operator).  
Parentheses for functions with one argument are not always necessary, `sin 30` (note the space) is the same as `sin(30)`. However, functions have the highest precedence so, `sin 30*10` is the same as `sin(30)*10`.

`{x}` (array operators)

These operators are used to process array-like structures (within an expression these characters do not act like  $\TeX$  grouping tokens). The *array specification* consists of comma separated elements, for example, `{1, 2, 3, 4, 5}`. Each element in the array will be evaluated as it is parsed, so expressions can be used. In addition, an element of an array can be an array itself, allowing multiple dimension arrays to be simulated: `{1, {2,3}, {4,5}, 6}`. When storing an array in a macro, do not forget the surrounding braces: `\def\myarray{{1,2,3}}` not `\def\myarray{1,2,3}`.

1, two, 3.0, IV, cinq, sechs, 7.0,

```
\def\myarray{{1,"two",2+1,"IV","cinq","sechs",sin(\i*5)*14}}
\foreach \i in {0,...,6}{\pgfmathparse{\myarray[\i]}\pgfmathresult, }
```

`[x]` (array access operators; use the `array` function)

`[` and `]` are two operators used in one particular circumstance: to access an array (specified using the `{` and `}` operators) using the index `x`. Indexing starts from zero, so, if the index is greater than, or equal to, the number of values in the array, an error will occur, and zero will be returned.

```
-9.0 \def\myarray{{7,-3,4,-9,11}}
\pgfmathparse{\myarray[3]} \pgfmathresult
```

If the array is defined to have multiple dimensions then the array access operators can be immediately repeated.

```
1 0 0 \def\print#1{\pgfmathparse{#1}\pgfmathresult}
0 1 0 \def\identitymatrix{{1,0,0},{0,1,0},{0,0,1}}
0 0 1 \tikz[x=0.5cm,y=0.5cm]\foreach \i in {0,1,2} \foreach \j in {0,1,2}
\draw [anchor=base] (\i,\j) node at (\j,-\i) [anchor=base] {\print{\identitymatrix[\i][\j]}};
```

`"x"` (group operators)

These operators are used to quote `x`. However, as every expression is expanded with `\edef` before it is parsed, macros (e.g., font commands like `\tt` or `\Huge`) may need to be “protected” from this expansion (e.g., `\noexpand\Huge`). Ideally, you should avoid such macros anyway. Obviously, these operators should be used with great care as further calculations are unlikely to be possible with the result.

5 is Bigger than 0. 5 is smaller than 10.

```
\def\x{5}
\foreach \y in {0,10}{
\pgfmathparse{\x > \y ? "\noexpand\Large Bigger" : "\noexpand\tiny smaller"}
\x is \pgfmathresult\ than \y.
}
```

## 63.2 Functions

The following functions are recognised:

|                    |                        |                         |                         |                     |                       |
|--------------------|------------------------|-------------------------|-------------------------|---------------------|-----------------------|
| <code>abs</code>   | <code>cosec</code>     | <code>floor</code>      | <code>log2</code>       | <code>oct</code>    | <code>sin</code>      |
| <code>acos</code>  | <code>cosh</code>      | <code>frac</code>       | <code>max</code>        | <code>or</code>     | <code>sinh</code>     |
| <code>add</code>   | <code>cot</code>       | <code>greater</code>    | <code>min</code>        | <code>pi</code>     | <code>sqrt</code>     |
| <code>and</code>   | <code>deg</code>       | <code>height</code>     | <code>mod</code>        | <code>pow</code>    | <code>subtract</code> |
| <code>array</code> | <code>depth</code>     | <code>hex</code>        | <code>Mod</code>        | <code>rad</code>    | <code>tan</code>      |
| <code>asin</code>  | <code>div</code>       | <code>Hex</code>        | <code>multiply</code>   | <code>rand</code>   | <code>tanh</code>     |
| <code>atan</code>  | <code>divide</code>    | <code>int</code>        | <code>neg</code>        | <code>random</code> | <code>true</code>     |
| <code>atan2</code> | <code>e</code>         | <code>ifthenelse</code> | <code>not</code>        | <code>real</code>   | <code>veclen</code>   |
| <code>bin</code>   | <code>equal</code>     | <code>less</code>       | <code>notequal</code>   | <code>rnd</code>    | <code>width</code>    |
| <code>ceil</code>  | <code>factorial</code> | <code>ln</code>         | <code>notgreater</code> | <code>round</code>  |                       |
| <code>cos</code>   | <code>false</code>     | <code>log10</code>      | <code>notless</code>    | <code>sec</code>    |                       |

Each function has a PGF command associated with it (which is also shown with the function below). In general the the command is simply the name of the function prefixed with `\pgfmath`, for example, `\pgfmathadd`, but there are some notable exceptions.

### 63.2.1 Basic arithmetic functions

`add(x, y)`

`\pgfmathadd{x}{y}`

Adds  $x$  and  $y$ .

81.0 `\pgfmathparse{add(75,6)} \pgfmathresult`

`subtract(x, y)`

`\pgfmathsubtract{x}{y}`

Subtract  $x$  from  $y$ .

69.0 `\pgfmathparse{subtract(75,6)} \pgfmathresult`

`neg(x)`

`\pgfmathneg{x}`

This returns  $-x$ .

-50.0 `\pgfmathparse{neg(50)} \pgfmathresult`

`multiply(x, y)`

`\pgfmathmultiply{x}{y}`

Multiply  $x$  by  $y$ .

450.0 `\pgfmathparse{multiply(75,6)} \pgfmathresult`

`divide(x, y)`

`\pgfmathdivide{x}{y}`

Divide  $x$  by  $y$ .

12.5 `\pgfmathparse{divide(75,6)} \pgfmathresult`

`div(x, y)`

`\pgfmathdiv{x}{y}`

Divide  $x$  by  $y$  and round to the nearest integer

8 `\pgfmathparse{div(75,9)} \pgfmathresult`

`factorial(x)`

`\pgfmathfactorial{x}`

Return  $x!$ .

120.0 `\pgfmathparse{factorial(5)} \pgfmathresult`

`sqrt(x)`

`\pgfmathsqrt{x}`

Calculates  $\sqrt{x}$ .

3.16227 `\pgfmathparse{sqrt(10)} \pgfmathresult`

93.62388 `\pgfmathparse{sqrt(8765.432)} \pgfmathresult`

`pow(x, y)`  
`\pgfmathpow{x}{y}`

Raises  $x$  to the power  $y$ . For greatest accuracy  $y$  should be an integer. If  $y$  is not an integer the actual calculation will be an approximation of  $e^{y\ln(x)}$ .

128.0 `\pgfmathparse{pow(2,7)} \pgfmathresult`

`e`  
`\pgfmathe`

Returns the value 2.718281828.

3.62685 `\pgfmathparse{(e^2-e^-2)/2} \pgfmathresult`

`exp(x)`  
`\pgfmathexp{x}`

Maclaurin series for  $e^x$ .

2.71825 `\pgfmathparse{exp(1)} \pgfmathresult`

10.38083 `\pgfmathparse{exp(2.34)} \pgfmathresult`

`ln(x)`  
`\pgfmathln{x}`

An approximation for  $\ln(x)$ . This uses an algorithm due to Rouben Rostamian, and coefficients suggested by Alain Matthes.

2.30257 `\pgfmathparse{ln(10)} \pgfmathresult`

4.99997 `\pgfmathparse{ln(exp(5))} \pgfmathresult`

`log10(x)`  
`\pgfmathlogten{x}`

An approximation for  $\log_{10}(x)$ .

1.99997 `\pgfmathparse{log10(100)} \pgfmathresult`

`log2(x)`  
`\pgfmathlogtwo{x}`

An approximation for  $\log_2(x)$ .

6.99994 `\pgfmathparse{log2(128)} \pgfmathresult`

`abs(x)`  
`\pgfmathabs{x}`

Evaluates the absolute value of  $x$ .

5.0 `\pgfmathparse{abs(-5)} \pgfmathresult`

-12.0 `\pgfmathparse{-abs(4*-3)} \pgfmathresult`

`mod(x, y)`

`\pgfmathmod{x}{y}`

This evaluates  $x$  modulo  $y$ , using truncated division. The sign of the result is the same as the sign of  $\frac{x}{y}$ .

2.0 `\pgfmathparse{mod(20,6)} \pgfmathresult`

-10.0 `\pgfmathparse{mod(-100,30)} \pgfmathresult`

`Mod(x,y)`

`\pgfmathMod{x}{y}`

This evaluates  $x$  modulo  $y$ , using floored division. The sign of the result is never negative.

20.0 `\pgfmathparse{Mod(-100,30)} \pgfmathresult`

### 63.2.2 Rounding functions

`round(x)`

`\pgfmathround{x}`

Rounds  $x$  to the nearest integer. It uses “asymmetric half-up” rounding. So 1.5 is rounded to 2, but -1.5 is rounded to -2 (*not* 1).

2.0 `\pgfmathparse{round(32.5/17)} \pgfmathresult`

33.0 `\pgfmathparse{round(398/12)} \pgfmathresult`

`floor(x)`

`\pgfmathfloor{x}`

Rounds  $x$  down to the nearest integer.

1.0 `\pgfmathparse{floor(32.5/17)} \pgfmathresult`

33.0 `\pgfmathparse{floor(398/12)} \pgfmathresult`

`ceil(x)`

`\pgfmathceil{x}`

Rounds  $x$  up to the nearest integer.

2.0 `\pgfmathparse{ceil(32.5/17)} \pgfmathresult`

34.0 `\pgfmathparse{ceil(398/12)} \pgfmathresult`

`int(x)`

`\pgfmathint{x}`

Returns the integer part of  $x$ .

1 `\pgfmathparse{int(32.5/17)} \pgfmathresult`

`frac(x)`

`\pgfmathfrac{x}`

Returns the fractional part of  $x$ .

0.91176 `\pgfmathparse{frac(32.5/17)} \pgfmathresult`

`real(x)`

`\pgfmathreal{x}`

Ensures  $x$  contains a decimal point.

4.0 `\pgfmathparse{real(4)} \pgfmathresult`



### 63.2.3 Trigonometric functions

`pi`

`\pgfmathpi`

Returns the value  $\pi = 3.141592654$ .

3.141592654 `\pgfmathparse{pi} \pgfmathresult`

179.99962 `\pgfmathparse{pi r} \pgfmathresult`

`rad(x)`

`\pgfmathrad{x}`

Convert  $x$  to radians.  $x$  is assumed to be in degrees.

1.57079 `\pgfmathparse{rad(90)} \pgfmathresult`

`deg(x)`

`\pgfmathdeg{x}`

Convert  $x$  to degrees.  $x$  is assumed to be in radians.

269.999 `\pgfmathparse{deg(3*pi/2)} \pgfmathresult`

`sin(x)`

`\pgfmathsin{x}`

Sine of  $x$ . By employing the `r` operator,  $x$  can be in radians.

0.86603 `\pgfmathparse{sin(60)} \pgfmathresult`

0.86601 `\pgfmathparse{sin(pi/3 r)} \pgfmathresult`

`cos(x)`

`\pgfmathcos{x}`

Cosine of  $x$ . By employing the `r` operator,  $x$  can be in radians.

0.5 `\pgfmathparse{cos(60)} \pgfmathresult`

0.49998 `\pgfmathparse{cos(pi/3 r)} \pgfmathresult`

`tan(x)`

`\pgfmathtan{x}`

Tangent of  $x$ . By employing the `r` operator,  $x$  can be in radians.

1.00005 `\pgfmathparse{tan(45)} \pgfmathresult`

1.0 `\pgfmathparse{tan(2*pi/8 r)} \pgfmathresult`

`sec(x)`

`\pgfmathsec{x}`

Secant of  $x$ . By employing the `r` operator,  $x$  can be in radians.

1.41429 `\pgfmathparse{sec(45)} \pgfmathresult`

`cosec(x)`

`\pgfmathcosec{x}`

Cosecant of  $x$ . By employing the `r` operator,  $x$  can be in radians.

2.0 `\pgfmathparse{cosec(30)} \pgfmathresult`

`cot(x)`

`\pgfmathcot{x}`

Cotangent of  $x$ . By employing the `r` operator,  $x$  can be in radians.

3.73215 `\pgfmathparse{cot(15)} \pgfmathresult`

`asin(x)`

`\pgfmathasin{x}`

Arcsine of  $x$ . The result is in degrees and in the range  $\pm 90^\circ$ .

44.99135 `\pgfmathparse{asin(0.7071)} \pgfmathresult`

`acos(x)`

`\pgfmathacos{x}`

Arccosine of  $x$  in degrees. The result is in the range  $[0^\circ, 180^\circ]$ .

60.0 `\pgfmathparse{acos(0.5)} \pgfmathresult`

`atan(x)`

`\pgfmathatan{x}`

Arctangent of  $x$  in degrees.

45.0 `\pgfmathparse{atan(1)} \pgfmathresult`

`atan2(x,y)`

`\pgfmathatantwo{x}{y}`

Arctangent of  $y \div x$  in degrees. This also takes into account the quadrants.

143.13011 `\pgfmathparse{atan2(-4,3)} \pgfmathresult`

#### 63.2.4 Comparison and logical functions

`equal(x,y)`

`\pgfmathequal{x}{y}`

This returns 1 if  $x = y$  and 0 otherwise.

1 `\pgfmathparse{equal(20,20)} \pgfmathresult`

`greater(x,y)`

`\pgfmathgreater{x}{y}`

This returns 1 if  $x > y$  and 0 otherwise.

0 `\pgfmathparse{greater(20,25)} \pgfmathresult`

`less(x,y)`

`\pgfmathless{x}{y}`

This returns 1 if  $x < y$  and 0 otherwise.

0 `\pgfmathparse{greater(20,25)} \pgfmathresult`

`notequal(x,y)`  
`\pgfmathnotequal{x}{y}`

This returns 0 if  $x = y$  and 1 otherwise.

```
1 \pgfmathparse{notequal(20,25)} \pgfmathresult
```

`notgreater(x,y)`  
`\pgfmathnotgreater{x}{y}`

This returns 1 if  $x \leq y$  and 0 otherwise.

```
1 \pgfmathparse{notgreater(20,25)} \pgfmathresult
```

`notless(x,y)`  
`\pgfmathnotless{x}{y}`

This returns 1 if  $x \geq y$  and 0 otherwise.

```
0 \pgfmathparse{notless(20,25)} \pgfmathresult
```

`and(x,y)`  
`\pgfmathand{x}{y}`

This returns 1 if  $x$  and  $y$  both evaluate to non-zero values. Otherwise 0 is returned.

```
0 \pgfmathparse{and(5>4,6>7)} \pgfmathresult
```

`or(x,y)`  
`\pgfmathor{x}{y}`

This returns 1 if either  $x$  or  $y$  evaluate to non-zero values. Otherwise 0 is returned.

```
0 \pgfmathparse{and(5>4,6>7)} \pgfmathresult
```

`not(x)`  
`\pgfmathnot{x}`

This returns 1 if  $x = 0$ , otherwise 0.

```
0 \pgfmathparse{not(true)} \pgfmathresult
```

`ifthenelse(x,y,z)`  
`\pgfmathifthenelse{x}{y}{z}`

This returns  $y$  if  $x$  evaluates to some non-zero value, otherwise  $z$  is returned.

```
no \pgfmathparse{ifthenelse(5==4,"yes","no")} \pgfmathresult
```

`true`  
`\pgfmathtrue`

This evaluates to 1.

```
yes \pgfmathparse{true ? "yes" : "no"} \pgfmathresult
```

`false`  
`\pgfmathfalse`

This evaluates to 0.

```
no \pgfmathparse{false ? "yes" : "no"} \pgfmathresult
```

### 63.2.5 Pseudo-random functions

rnd

`\pgfmathrnd`

Generates a pseudo-random number between 0 and 1.

```
0.35255, 0.52394, 0.9081, 0.07314, 0.01263, 0.86674, 0.42123, 0.63577, 0.0252, 0.1887,
```

```
\foreach \x in {1,...,10}{\pgfmathparse{rnd}\pgfmathresult, }
```

rand

`\pgfmathrand`

Generates a pseudo-random number between -1 and 1.

```
-0.171, -0.6502, 0.80553, 0.81995, 0.18893, 0.25227, 0.83768, -0.39989, -0.43884, 0.51918,
```

```
\foreach \x in {1,...,10}{\pgfmathparse{rand}\pgfmathresult, }
```

random( $x, y$ )

`\pgfmathrandom{x, y}`

This function takes zero, one or two arguments. If there are zero arguments, a random number between 0 and 1 is generated. If there is one argument  $x$ , a random integer between 1 and  $x$  is generated. Finally, if there are two arguments, a random integer between  $x$  and  $y$  is generated. If there are no arguments the PGF command should be called as follows: `\pgfmathrandom{}`.

```
0.67236, 0.3279, 0.01428, 0.76451, 0.26901, 0.00323, 0.03891, 0.40141, 0.8682, 0.51057,
```

```
\foreach \x in {1,...,10}{\pgfmathparse{random()}\pgfmathresult, }
```

```
52, 2, 17, 39, 1, 53, 85, 42, 100, 39,
```

```
\foreach \x in {1,...,10}{\pgfmathparse{random(100)}\pgfmathresult, }
```

```
619, 426, 467, 758, 569, 493, 674, 626, 614, 400,
```

```
\foreach \x in {1,...,10}{\pgfmathparse{random(232,762)}\pgfmathresult, }
```

### 63.2.6 Base conversion functions

hex( $x$ )

`\pgfmathhex{x}`

Convert  $x$  (assumed to be an integer in base 10) to a hexadecimal representation, using lower case alphabetic digits. No further calculation will be possible with the result.

```
fff \pgfmathparse{hex(65535)} \pgfmathresult
```

Hex( $x$ )

`\pgfmathHex{x}`

Convert  $x$  (assumed to be an integer in base 10) to a hexadecimal representation, using upper case alphabetic digits. No further calculation will be possible with the result.

```
FFFF \pgfmathparse{Hex(65535)} \pgfmathresult
```

oct( $x$ )

`\pgfmathoct{x}`

Convert  $x$  (assumed to be an integer in base 10) to a octal representation. No further calculation should be attempted with the result, as the parser can only process numbers converted to base 10.

```
77 \pgfmathparse{oct(63)} \pgfmathresult
```

`bin( $x$ )`  
`\pgfmathbin{ $x$ }`

Convert  $x$  (assumed to be an integer in base 10) to a binary representation. No further calculation should be attempted with the result, as the parser can only process numbers converted to base 10.

10111001 `\pgfmathparse{bin(185)} \pgfmathresult`

### 63.2.7 Miscellaneous functions

`min( $x_1, x_2, \dots, x_n$ )`  
`\pgfmathmin{ $x_1, x_2, \dots$ }{ $\dots, x_{n-1}, x_n$ }`

Return the minimum value from  $x_1 \dots x_n$ . For historical reasons, the command `\pgfmathmin` takes two arguments, but each of these can contain an arbitrary number of comma separated values.

-8.0 `\pgfmathparse{min(3,4,-2,250,-8,100)} \pgfmathresult`

`max( $x_1, x_2, \dots, x_n$ )`  
`\pgfmathmax{ $x_1, x_2, \dots$ }{ $\dots, x_{n-1}, x_n$ }`

Return the maximum value from  $x_1 \dots x_n$ . Again, for historical reasons, the command `\pgfmathmax` takes two arguments, but each of these can contain an arbitrary number of comma separated values.

250.0 `\pgfmathparse{max(3,4,-2,250,-8,100)} \pgfmathresult`

`veclen( $x, y$ )`  
`\pgfmathveclen{ $x$ }{ $y$ }`

Calculates  $\sqrt{(x^2 + y^2)}$ . This uses a polynomial approximation, based on ideas due to Rouben Rostamian

12.99976 `\pgfmathparse{veclen(12,5)} \pgfmathresult`

`array( $x, y$ )`  
`\pgfmatharray{ $x$ }{ $y$ }`

This accesses the array  $x$  at the index  $y$ . The array must begin and end with braces (e.g.,  $\{1,2,3,4\}$ ) and array indexing starts at 0.

17 `\pgfmathparse{array({9,13,17,21},2)} \pgfmathresult`

The following hyperbolic functions were adapted from code suggested by Martin Heller:

`sinh( $x$ )`  
`\pgfmathsinh{ $x$ }`

The hyperbolic sine of  $x$

0.52103 `\pgfmathparse{sinh(0.5)} \pgfmathresult`

`cosh( $x$ )`  
`\pgfmathcosh{ $x$ }`

The hyperbolic cosine of  $x$

1.12767 `\pgfmathparse{cosh(0.5)} \pgfmathresult`

`tanh( $x$ )`  
`\pgfmathtanh{ $x$ }`

The hyperbolic tangent of  $x$

0.46204 `\pgfmathparse{tanh(0.5)} \pgfmathresult`

`width("x")`  
`\pgfmathwidth{"x"}`

Return the width of a T<sub>E</sub>X (horizontal) box containing  $x$ . The quote characters are necessary to prevent  $x$  being parsed. It is important to remember that any expression is expanded with `\edef` before being parsed, so any macros (e.g., font commands like `\tt` or `\Huge`) will need to be “protected” (e.g., `\noexpand\Huge` is usually sufficient).

```
78.47237 \pgfmathparse{width("Some Lovely Text")} \pgfmathresult
```

`height("x")`  
`\pgfmathheight{"x"}`

Return the height of a box containing  $x$ .

```
6.94444 \pgfmathparse{height("Some Lovely Text")} \pgfmathresult
```

`depth("x")`  
`\pgfmathdepth{"x"}`

Returns the depth of a box containing  $x$ .

```
1.94444 \pgfmathparse{depth("Some Lovely Text")} \pgfmathresult
```

## 64 Additional Mathematical Commands

Instead of parsing and evaluating complex expressions, you can also use the mathematical engine to evaluate a single mathematical operation. The macros used for many of these computations are listed above in Section 63.2. PGF also provides some additional commands which are shown below:

### 64.1 Basic arithmetic functions

In addition to the commands described in Section 63.2.1, the following command is provided:

`\pgfmathreciprocal{⟨x⟩}`

Defines `\pgfmathresult` as  $1 \div \langle x \rangle$ . This provides greatest accuracy when  $x$  is small.

### 64.2 Comparison and logical functions

In addition to the commands described in Section 63.2.4, the following command was provided by Christian Feuersänger:

`\pgfmathapproxequalto{⟨x⟩}{⟨y⟩}`

Defines `\pgfmathresult` 1.0 if  $|\langle x \rangle - \langle y \rangle| < 0.0001$ , but 0.0 otherwise. As a side-effect, the global boolean `\ifpgfmathcomparison` will be set accordingly.

### 64.3 Pseudo-Random Numbers

In addition to the commands described in Section 63.2.5, the following commands are provided:

`\pgfmathgeneratepseudorandomnumber`

Defines `\pgfmathresult` as a pseudo-random integer between 1 and  $2^{31} - 1$ . This uses a linear congruency generator, based on ideas due to Erich Janka.

`\pgfmathrandominteger{⟨macro⟩}{⟨maximum⟩}{⟨minimum⟩}`

This defines `⟨macro⟩` as a pseudo-randomly generated integer from the range `⟨maximum⟩` to `⟨minimum⟩` (inclusive).

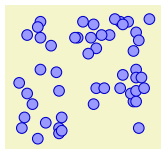

```
\begin{pgfpicture}
  \foreach \x in {1,...,50}{
    \pgfmathrandominteger{\a}{1}{50}
    \pgfmathrandominteger{\b}{1}{50}
    \pgfpathcircle{\pgfpoint{+\a pt}{+\b pt}}{+2pt}
    \color{blue!40!white}
    \pgfsetstrokecolor{blue!80!black}
    \pgfusepath{stroke, fill}
  }
\end{pgfpicture}
```

`\pgfmathdeclarerandomlist{⟨list name⟩}{⟨item-1⟩}{⟨item 2⟩}...`

This creates a list of items with the name `⟨list name⟩`.

`\pgfmathrandomitem{⟨macro⟩}{⟨list name⟩}`

Select an item from a random list `⟨list name⟩`. The selected item is placed in `⟨macro⟩`.

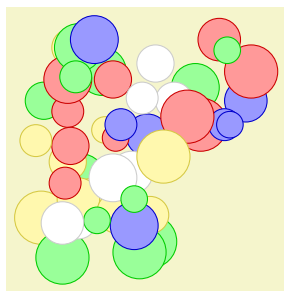

```
\begin{pgfpicture}
  \pgfmathdeclarerandomlist{color}{{red}{blue}{green}{yellow}{white}}
  \foreach \a in {1,...,50}{
    \pgfmathrandominteger{\x}{1}{85}
    \pgfmathrandominteger{\y}{1}{85}
    \pgfmathrandominteger{\r}{5}{10}
    \pgfmathrandomitem{\c}{color}
    \pgfpathcircle{\pgfpoint{+\x pt}{+\y pt}}{+\r pt}
    \color{\c!40!white}
    \pgfsetstrokecolor{\c!80!black}
    \pgfusepath{stroke, fill}
  }
\end{pgfpicture}
```

`\pgfmathsetseed{⟨integer⟩}`

Explicitly set seed for the pseudo-random number generator. By default it is set to the value of `\time×\year`.

## 64.4 Base Conversion

PGF provides limited support for conversion between *representations* of numbers. Currently the numbers must be positive integers in the range 0 to  $2^{31} - 1$ , and the bases in the range 2 to 36. All digits representing numbers greater than 9 (in base ten), are alphabetic, but may be upper or lower case.

In addition to the commands described in Section 63.2.6, the following commands are provided:

`\pgfmathbasetodec{⟨macro⟩}{⟨number⟩}{⟨base⟩}`

Defines `⟨macro⟩` as the result of converting `⟨number⟩` from base `⟨base⟩` to base 10. Alphabetic digits can be upper or lower case.

```
4223 \pgfmathbasetodec\mynumber{107f}{16} \mynumber
```

```
25512 \pgfmathbasetodec\mynumber{33FC}{20} \mynumber
```

`\pgfmathdectobase{⟨macro⟩}{⟨number⟩}{⟨base⟩}`

Defines `⟨macro⟩` as the result of converting `⟨number⟩` from base 10 to base `⟨base⟩`. Any resulting alphabetic digits are in *lower case*.

```
ffff \pgfmathdectobase\mynumber{65535}{16} \mynumber
```

`\pgfmathdectoBase{⟨macro⟩}{⟨number⟩}{⟨base⟩}`

Defines `⟨macro⟩` as the result of converting `⟨number⟩` from base 10 to base `⟨base⟩`. Any resulting alphabetic digits are in *upper case*.

```
FFFF \pgfmathdectoBase\mynumber{65535}{16} \mynumber
```

`\pgfmathbasetobase{⟨macro⟩}{⟨number⟩}{⟨base-1⟩}{⟨base-2⟩}`

Defines `⟨macro⟩` as the result of converting `⟨number⟩` from base `⟨base-1⟩` to base `⟨base-2⟩`. Alphabetic digits in `⟨number⟩` can be upper or lower case, but any resulting alphabetic digits are in *lower case*.

```
db \pgfmathbasetobase\mynumber{11011011}{2}{16} \mynumber
```

`\pgfmathbasetoBase{⟨macro⟩}{⟨number⟩}{⟨base-1⟩}{⟨base-2⟩}`

Defines `⟨macro⟩` as the result of converting `⟨number⟩` from base `⟨base-1⟩` to base `⟨base-2⟩`. Alphabetic digits in `⟨number⟩` can be upper or lower case, but any resulting alphabetic digits are in *upper case*.

```
31B \pgfmathbasetoBase\mynumber{121212}{3}{12} \mynumber
```

`\pgfmathsetbasenumberlength{⟨integer⟩}`

Set the number of digits in the result of a base conversion to `⟨integer⟩`. If the result of a conversion has less digits than this number it is prefixed with zeros.

```
00001111 \pgfmathsetbasenumberlength{8}
\pgfmathdectobase\mynumber{15}{2} \mynumber
```



## 65 Customising the Mathematical Engine

Perhaps you have a desire for some function that PGF does not provide. Perhaps you are not happy with the accuracy or efficiency of some of the algorithms that are implemented in PGF. In these cases you will want to add a function to the parser or replace the current implementations of the algorithms with your own code.

The mathematical engine was designed with such customisation in mind. It is possible to add new functions, or modify the code for existing functions. Note, however, that whilst adding new operators is possible, it can be a rather tricky business and is only recommended for adventurous users.

To add a new function to the math engine the following command can be used:

```
\pgfmathdeclarefunction{function name}{number of arguments}{code}
```

This will set up the parser to recognise a function called *name*. The name of the function can consist of, uppercase or lower case letters, numbers or the underscore `_`. In line with many programming languages, a function name cannot begin with a number or contain any spaces.

The *number of arguments* can be any positive integer, zero, or the value `...`, which indicates a variable number of arguments. PGF treats constants, such as `pi` and `e`, as functions with zero arguments. Functions with more than nine arguments or with variable arguments are a “bit special” and are discussed below.

The effect of *code* should be to set the macro `\pgfmathresult` to the correct value (namely to the result of the computation without units). Furthermore, the function should have no other side effects, that is, it should not change any global values. As an example, consider the creation of a new function `double`, which takes one argument, and returns the value of that argument times two.

```
88.6 \makeatletter
      \pgfmathdeclarefunction{double}{1}{
        \begingroup
          \pgf@x=#1pt\relax
          \multiply\pgf@x by2\relax
          \pgfmathreturn\pgf@x
        \endgroup
      }
      \makeatother
      \pgfmathparse{double(44.3)}\pgfmathresult
```

The macro `\pgfmathreturn`(*tokens*) must be directly followed by an `\endgroup` and will save the result of the computation, by defining `\pgfmathresult` as the expansion of *tokens* (without units) outside the group, so *tokens* must be something that can be assigned to a dimension register.

Alternatively, the `\pgfmathsmuggle`(*macro*) can be used. This must also be directly followed by an `\endgroup` and will simply “smuggle” the definition of *macro* outside the  $\TeX$ -group.

By performing computations within a  $\TeX$ -group, PGF registers such as `\pgf@x`, `\pgf@y` and `\c@pgf@counta`, `\c@pgf@countb`, and so forth, can be used at will.

Beyond setting up the parser, this command also defines two macros which provide access to the function independently of the parser:

- `\pgfmath`(*function name*)  
This macro will provide “public” interface for the function *function name* allowing the function to be called independently of the parser. All arguments passed to this macro are evaluated using `\pgfmathparse` and then passed on to the following macro:
- `\pgfmath`(*function name*)@  
This macro is the “private” implementation of the functions algorithm (but note that, for speed, the parser calls this macro rather than the “public” one). Arguments passed to this macro are expected to be numbers without units. It is defined using *code*, but need not be self contained.

For functions that are declared with less than ten arguments, the public macro is defined in the same way as normal  $\TeX$  macros using, for example, `\def\pgfmathNoArgs{code}` for a function with no arguments, or `\def\pgfmathThreeArgs#1#2#3{code}` for a function with three arguments. The private macro is defined in the same way, and each argument can therefore be accessed in *code* using `#1`, `#2` and so on.

For functions with more than nine arguments, or functions with a variable number of arguments, these macros are only defined as taking *one* argument. The public macro expects its arguments to be comma separated, for example, `\pgfmathVariableArgs{1.1,3.5,-1.5,2.6}`. Each argument is parsed and passed on to the private macro as follows: `\pgfmathVariableArgs@{1.1}{3.5}{-1.5}{2.6}`. This means that some “extra work” will be required to access each argument (although it is a fairly simple task).

Note, that there are, two exceptions to this arrangement: the public versions of the `min` and `max` functions still take two arguments for compatibility with older versions, but each of these arguments can take several comma separated values.

To redefine a function use the following command:

`\pgfmathredeclarefunction{function name}{algorithm code}`

This command redefines the `\pgfmath{function name}` macro with the new `algorithm code`. See the description of the `\pgfmathdeclarefunction` for details. You cannot change the number of arguments for an existing function.

PGF uses the last known definition of a function within the prevailing scope, so it is possible for a function to be redefined locally. You should also remember that any `.sty` or `.tex` file containing any re-implementations should be loaded after `pgf-Math`.

In addition to the above commands, the following key is provided to quickly create simple ad hoc functions which can greatly improve the readability of code, and is particularly useful in `TikZ`:

`/pgf/declare function=``function definitions` (no default)

This key allows simple functions to be created locally. Its use is perhaps best illustrated by an example:

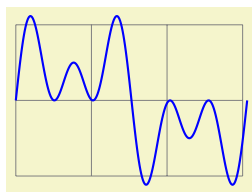

```
\begin{tikzpicture}
\draw [help lines] (0,0) grid (3,2);
\draw [blue, thick, x=0.0085cm, y=1cm,
declare function={
sines(\t,\a,\b)=1 + 0.5*(sin(\t)+sin(\t*\a)+sin(\t*\b));
}]
plot [domain=0:360, samples=144, smooth] (\x,{sines(\x,3,5)});
\end{tikzpicture}
```

Each definition in `function definitions` takes the form `name(arguments)=definition;` (note the semicolon at the end, this is very important). If multiple functions are being defined the semicolon is used to separate them (*not* a comma). The function `name` can be any name that is not already a function name in the current scope. The list of `arguments` are commands such as `\x`, or `\y` (it is not possible to declare functions that take variable numbers of arguments using this key). If the function takes no arguments then the parentheses need not be used. The `definition` should be an expression that can be parsed by the mathematical engine and should use the commands specified in `arguments`.

When specifying multiple functions, functions that appear later on in `function definitions` can refer to earlier functions:

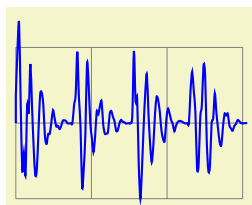

```
\begin{tikzpicture}[
declare function={
excitation(\t,\w) = sin(\t*\w);
noise = rnd - 0.5;
source(\t) = excitation(\t,20) + noise;
filter(\t) = 1 - abs(sin(mod(\t, 90)));
speech(\t) = 1 + source(\t)*filter(\t);
}
]
\draw [help lines] (0,0) grid (3,2);
\draw [blue, thick, x=0.0085cm, y=1cm] (0,1) --
plot [domain=0:360, samples=144, smooth] (\x,{speech(\x)});
\end{tikzpicture}
```

## 66 Number Printing

An extension by Christian Feuersänger

PGF supports number printing in different styles and rounds to arbitrary precision.

`\pgfmathprintnumber{⟨x⟩}`

Generates pretty-printed output for the (real) number  $\{⟨x⟩\}$ . The input number  $\{⟨x⟩\}$  is parsed using `\pgfmathfloatparsenumber` which allows arbitrary precision.

Numbers are typeset in math mode using the current set of number printing options, see below. Optional arguments can also be provided using `\pgfmathprintnumber[⟨options⟩]{⟨x⟩}`.

`\pgfmathprintnumberto{⟨x⟩}{⟨\macro⟩}`

Returns the resulting number into  $\{⟨\macro⟩\}$  instead of typesetting it directly.

`/pgf/number format/fixed` (no value)

Configures `\pgfmathprintnumber` to round the number to a fixed number of digits after the period, discarding any trailing zeros.

```
4.57 0 0.1 24,415.98 123,456.12
```

```
\pgfkeys{/pgf/number format/.cd,fixed,precision=2}
\pgfmathprintnumber{4.568}\hspace{1em}
\pgfmathprintnumber{5e-04}\hspace{1em}
\pgfmathprintnumber{0.1}\hspace{1em}
\pgfmathprintnumber{24415.98123}\hspace{1em}
\pgfmathprintnumber{123456.12345}
```

See section 66.1 for how to change the appearance.

`/pgf/number format/fixed zerofill=⟨boolean⟩` (default true)

Enables or disables zero filling for any number drawn in fixed point format.

```
4.57 0.00 0.10 24,415.98 123,456.12
```

```
\pgfkeys{/pgf/number format/.cd,fixed,fixed zerofill,precision=2}
\pgfmathprintnumber{4.568}\hspace{1em}
\pgfmathprintnumber{5e-04}\hspace{1em}
\pgfmathprintnumber{0.1}\hspace{1em}
\pgfmathprintnumber{24415.98123}\hspace{1em}
\pgfmathprintnumber{123456.12345}
```

This key affects numbers drawn with `fixed` or `std` styles (the latter only if no scientific format is chosen).

```
4.57 5 · 10-5 1.00 1.23 · 105
```

```
\pgfkeys{/pgf/number format/.cd,std,fixed zerofill,precision=2}
\pgfmathprintnumber{4.568}\hspace{1em}
\pgfmathprintnumber{5e-05}\hspace{1em}
\pgfmathprintnumber{1}\hspace{1em}
\pgfmathprintnumber{123456.12345}
```

See section 66.1 for how to change the appearance.

`/pgf/number format/sci` (no value)

Configures `\pgfmathprintnumber` to display numbers in scientific format, that means sign, mantisse and exponent (basis 10). The mantisse is rounded to the desired precision.

```
4.57 · 100 5 · 10-4 1 · 10-1 2.44 · 104 1.23 · 105
```

```
\pgfkeys{/pgf/number format/.cd,sci,precision=2}
\pgfmathprintnumber{4.568}\hspace{1em}
\pgfmathprintnumber{5e-04}\hspace{1em}
\pgfmathprintnumber{0.1}\hspace{1em}
\pgfmathprintnumber{24415.98123}\hspace{1em}
\pgfmathprintnumber{123456.12345}
```

See section 66.1 for how to change the exponential display style.

`/pgf/number format/sci zerofill={\langle boolean \rangle}` (default true)

Enables or disables zero filling for any number drawn in scientific format.

4.57 · 10<sup>0</sup> 5.00 · 10<sup>-4</sup> 1.00 · 10<sup>-1</sup> 2.44 · 10<sup>4</sup> 1.23 · 10<sup>5</sup>

```
\pgfkeys{/pgf/number format/.cd,sci,sci zerofill,precision=2}
\pgfmathprintnumber{4.568}\hspace{1em}
\pgfmathprintnumber{5e-04}\hspace{1em}
\pgfmathprintnumber{0.1}\hspace{1em}
\pgfmathprintnumber{24415.98123}\hspace{1em}
\pgfmathprintnumber{123456.12345}
```

As with `fixed zerofill`, this option does only affect numbers drawn in `sci` format (or `std` if the scientific format is chosen).

See section 66.1 for how to change the exponential display style.

`/pgf/number format/zerofill={\langle boolean \rangle}` (style, default true)

Sets both, `fixed zerofill` and `sci zerofill` at once.

`/pgf/number format/std` (no value)

Configures `\pgfmathprintnumber` to a standard algorithm. It chooses either `fixed` or `sci`, depending on the order of magnitude. Let  $n = s \cdot m \cdot 10^e$  be the input number and  $p$  the current precision. If  $-p/2 \leq e \leq 4$ , the number is displayed using the fixed format. Otherwise, it is displayed using the scientific format.

4.57 5 · 10<sup>-4</sup> 0.1 24,415.98 1.23 · 10<sup>5</sup>

```
\pgfkeys{/pgf/number format/.cd,std,precision=2}
\pgfmathprintnumber{4.568}\hspace{1em}
\pgfmathprintnumber{5e-04}\hspace{1em}
\pgfmathprintnumber{0.1}\hspace{1em}
\pgfmathprintnumber{24415.98123}\hspace{1em}
\pgfmathprintnumber{123456.12345}
```

`/pgf/number format/int detect` (no value)

Configures `\pgfmathprintnumber` to detect integers automatically. If the input number is an integer, no period is displayed at all. If not, the scientific format is chosen.

15 20 2.04 · 10<sup>1</sup> 1 · 10<sup>-2</sup> 0

```
\pgfkeys{/pgf/number format/.cd,int detect,precision=2}
\pgfmathprintnumber{15}\hspace{1em}
\pgfmathprintnumber{20}\hspace{1em}
\pgfmathprintnumber{20.4}\hspace{1em}
\pgfmathprintnumber{0.01}\hspace{1em}
\pgfmathprintnumber{0}
```

`/pgf/number format/int trunc` (no value)

Truncates every number to integers (discards any digit after the period).

4 0 0 24,415 123,456

```
\pgfkeys{/pgf/number format/.cd,int trunc}
\pgfmathprintnumber{4.568}\hspace{1em}
\pgfmathprintnumber{5e-04}\hspace{1em}
\pgfmathprintnumber{0.1}\hspace{1em}
\pgfmathprintnumber{24415.98123}\hspace{1em}
\pgfmathprintnumber{123456.12345}
```

`/pgf/number format/precision={\langle number \rangle}` (no default)

Sets the desired rounding precision for any display operation. For scientific format, this affects the mantisse.

## 66.1 Changing display styles

You can change the way how numbers are displayed. For example, if you use the ‘fixed’ style, the input number is rounded to the desired precision and the current fixed point display style is used to typeset the number. The same is applied to any other format: first, rounding routines are used to get the correct digits, afterwards a display style generates proper  $\TeX$ -code.

`/pgf/number format/set decimal separator={\langle text \rangle}` (no default)

Assigns  $\langle text \rangle$  as decimal separator for any fixed point numbers (including the mantisse in sci format).

Use `\pgfkeysgetvalue{/pgf/number format/set decimal separator}\value` to get the current separator into  $\value$ .

`/pgf/number format/dec sep={\langle text \rangle}` (style, no default)

Just another name for `set decimal separator`.

`/pgf/number format/set thousands separator={\langle text \rangle}` (no default)

Assigns  $\langle text \rangle$  as thousands separator for any fixed point numbers (including the mantisse in sci format).

```
1234.56 \pgfkeys{/pgf/number format/.cd,  
fixed,  
fixed zerofill,  
precision=2,  
set thousands separator={}}  
\pgfmathprintnumber{1234.56}
```

```
1234567890.00 \pgfkeys{/pgf/number format/.cd,  
fixed,  
fixed zerofill,  
precision=2,  
set thousands separator={}}  
\pgfmathprintnumber{1234567890}
```

```
1.234.567.890.00 \pgfkeys{/pgf/number format/.cd,  
fixed,  
fixed zerofill,  
precision=2,  
set thousands separator={.}}  
\pgfmathprintnumber{1234567890}
```

```
1, 234, 567, 890.00 \pgfkeys{/pgf/number format/.cd,  
fixed,  
fixed zerofill,  
precision=2,  
set thousands separator={,}}  
\pgfmathprintnumber{1234567890}
```

```
1,234,567,890.00 \pgfkeys{/pgf/number format/.cd,  
fixed,  
fixed zerofill,  
precision=2,  
set thousands separator={{,}}}  
\pgfmathprintnumber{1234567890}
```

The last example employs commas and disables the default comma-spacing.

Use `\pgfkeysgetvalue{/pgf/number format/set thousands separator}\value` to get the current separator into  $\value$ .

`/pgf/number format/1000 sep={\langle text \rangle}` (style, no default)

Just another name for `set thousands separator`.

`/pgf/number format/min exponent for 1000 sep={⟨number⟩}` (no default, initially 0)

Defines the smallest exponent in scientific notation which is required to draw thousand separators. The exponent is the number of digits minus one, so  $\langle number \rangle = 4$  will use thousand separators starting with  $1e4 = 10000$ .

```
5 000; 1 000 000 \pgfkeys{/pgf/number format/.cd,
int detect,
1000 sep={\,},
min exponent for 1000 sep=0}
\pgfmathprintnumber{5000}; \pgfmathprintnumber{1000000}
```

```
1000; 5000 \pgfkeys{/pgf/number format/.cd,
int detect,
1000 sep={\,},
min exponent for 1000 sep=4}
\pgfmathprintnumber{1000}; \pgfmathprintnumber{5000}
```

```
10 000; 1 000 000 \pgfkeys{/pgf/number format/.cd,
int detect,
1000 sep={\,},
min exponent for 1000 sep=4}
\pgfmathprintnumber{10000}; \pgfmathprintnumber{1000000}
```

A value of 0 disables this feature (negative values are ignored).

`/pgf/number format/use period` (no value)

A predefined style which installs periods ‘.’ as decimal separators and commas ‘,’ as thousands separators. This style is the default.

```
12.35 \pgfkeys{/pgf/number format/.cd, fixed, precision=2, use period}
\pgfmathprintnumber{12.3456}
```

```
1,234.56 \pgfkeys{/pgf/number format/.cd, fixed, precision=2, use period}
\pgfmathprintnumber{1234.56}
```

`/pgf/number format/use comma` (no value)

A predefined style which installs commas ‘,’ as decimal separators and periods ‘.’ as thousands separators.

```
12,35 \pgfkeys{/pgf/number format/.cd, fixed, precision=2, use comma}
\pgfmathprintnumber{12.3456}
```

```
1.234,56 \pgfkeys{/pgf/number format/.cd, fixed, precision=2, use comma}
\pgfmathprintnumber{1234.56}
```

`/pgf/number format/skip 0.= {⟨boolean⟩}` (no default, initially false)

Configures whether numbers like 0.1 shall be typeset as .1 or not.

```
.56 \pgfkeys{/pgf/number format/.cd,
fixed,
fixed zerofill, precision=2,
skip 0.}
\pgfmathprintnumber{0.56}
```

```
0.56 \pgfkeys{/pgf/number format/.cd,
fixed,
fixed zerofill, precision=2,
skip 0.=false}
\pgfmathprintnumber{0.56}
```

`/pgf/number format/showpos={\langle boolean \rangle}` (no default, initially false)  
 Enables or disables display of plus signs for non-negative numbers.

+12.35 `\pgfkeys{/pgf/number format/showpos}`  
`\pgfmathprintnumber{12.345}`

12.35 `\pgfkeys{/pgf/number format/showpos=false}`  
`\pgfmathprintnumber{12.345}`

+1.23 · 10<sup>1</sup> `\pgfkeys{/pgf/number format/.cd,showpos,sci}`  
`\pgfmathprintnumber{12.345}`

`/pgf/number format/print sign={\langle boolean \rangle}` (style, no default)  
 A style which is simply an alias for `showpos={\langle boolean \rangle}`.

`/pgf/number format/sci 10e` (no value)  
 Uses  $m \cdot 10^e$  for any number displayed in scientific format.

1.23 · 10<sup>1</sup> `\pgfkeys{/pgf/number format/.cd,sci,sci 10e}`  
`\pgfmathprintnumber{12.345}`

`/pgf/number format/sci 10e` (no value)  
 The same as ‘sci 10e’.

`/pgf/number format/sci e` (no value)  
 Uses the ‘1e+0’ format which is generated by common scientific tools for any number displayed in scientific format.

1.23e+1 `\pgfkeys{/pgf/number format/.cd,sci,sci e}`  
`\pgfmathprintnumber{12.345}`

`/pgf/number format/sci E` (no value)  
 The same with an uppercase ‘E’.

1.23E+1 `\pgfkeys{/pgf/number format/.cd,sci,sci E}`  
`\pgfmathprintnumber{12.345}`

`/pgf/number format/sci subscript` (no value)  
 Typesets the exponent as subscript for any number displayed in scientific format. This style requires very few space.

1.23<sub>1</sub> `\pgfkeys{/pgf/number format/.cd,sci,sci subscript}`  
`\pgfmathprintnumber{12.345}`

`/pgf/number format/sci superscript` (no value)  
 Typesets the exponent as superscript for any number displayed in scientific format. This style requires very few space.

1.23<sup>1</sup> `\pgfkeys{/pgf/number format/.cd,sci,sci superscript}`  
`\pgfmathprintnumber{12.345}`

`/pgf/number format/assume math mode={\langle boolean \rangle}` (default true)  
 Set this to true if you don’t want any checks for math mode. The initial setting checks whether math mode is active using `\pgfutilensuremath` for each final number.  
 Use `assume math mode=true` if you know that math mode is active. In that case, the final number is typeset as-is, no further checking is performed.

`/pgf/number format/@dec sep mark={\text}` (no default)

Will be placed right before the place where a decimal separator belongs to. However, `{\text}` will be inserted even if there is no decimal separator. It is intended as place-holder for auxiliary routines to find alignment positions.

This key should never be used to change the decimal separator! Use `dec sep` instead.

`/pgf/number format/@sci exponent mark={\text}` (no default)

Will be placed right before exponents in scientific notation. It is intended as place-holder for auxiliary routines to find alignment positions.

This key should never be used to change the exponent!



## 67 Object-Oriented Programming

This section describes the `oo` module.

```
\usepgfmodule{oo} %  $\TeX$  and plain  $\TeX$  and pure pgf
\usepgfmodule[oo] %  $\text{Con}\TeX$ t and pure pgf
```

This module defines a relatively small set of  $\TeX$  commands for defining classes, methods, attributes and objects in the sense of object-oriented programming.

In this chapter it is assumed that you are familiar with the basics of a typical object-oriented programming language like Java, C++ or Eiffel.

### 67.1 Overview

$\TeX$  does not support object-oriented programming, presumably because it was written at a time when this style of programming was not yet “en vogue.” When one is used to the object-oriented style of thinking, some programming constructs in  $\TeX$  often seem overly complicated. The object-oriented programming module of PGF may help here. It is written completely using simple  $\TeX$  macros and is, thus, perfectly portable. This also means, however, that it is not particularly fast (but not too slow either), so you should use it only for non-time-critical things.

Basically, the `oo`-system supports *classes* (in the object-oriented sense, this has nothing to do with  $\LaTeX$ -classes), *methods*, *constructores*, *attributes*, *objects*, and *object identities*. It (currently) does not support either inheritance, overloading, destructors, or class nesting.

The first step is to define a class, using the macro `\pgfooclass` (all normal macros in PGF’s object-oriented system start with `\pgfoo`). This macro gets the name of a class and in its body a number of *methods* are defined. These are defined using the `\method` macro (which is defined only inside such a class definition) and they look a bit like method definitions in, say, Java. Object attributes are declared using the `\attribute` command, which is also defined only inside a class definition.

Once a class has been defined, you can create objects of this class. Objects are created using `\pgfoonew`. Such an object has many characteristics of objects in a normal object-oriented programming language: Each object has a *unique identity*, so when you create another object this object is completely distinct from all other objects. Each object also has a set of private attributes, which may change over time. Suppose, for instance, that we have a `point` class. Then creating a new object (called an instance) of this class would typically have an `x`-attribute and a `y`-attribute. These can be changed over time. Creating another instance of the `point` class creates another object with its own `x`- and `y`-attributes.

Given an object, you can call a method for this object. Inside the method the attributes of the object for which the method is being called can be accessed.

The life of an object always ends with the end of the  $\TeX$  scope in which it was created. However, changes to attribute values are not local to scopes, so when you change an attribute anywhere, this change persists till the end of the life of the object or until the attribute is changed again.

### 67.2 A Running Example: The Stamp Class

As a running example we will develop a `stamp` class and `stamp` objects. The idea is that a stamp object is able to “stamp something” on a picture. This means that a stamp object has an attribute storing the “stamp text” and there is a method that asks the object to place this text somewhere on a canvas. The method can be called repeatedly and there can be several different stamp objects, each producing a different text. Stamp objects can either be created dynamically when needed or a library might define many such objects in an outer scope.

Such stamps are similar to many things present in PGF such as arrow tips, patterns, or shadings and, indeed, these could all have been implemented in this object-oriented fashion (which might have been better, but the object-oriented subsystem is a fairly new addition to PGF).

### 67.3 Classes

We start with the definition of the `stamp` class. This is done using the `\pgfooclass` macro:

```
\pgfooclass{\class name}{\body}
```

This command defines a class named  $\langle class\ name \rangle$ . The name of the class can contain spaces and most other characters, but no periods. So, valid class names are `MyClass` or `my class` or `Class_C++_emulation??1`.

The  $\langle body \rangle$  is actually just executed, so any normal T<sub>E</sub>X-code is permissible here. However, while the  $\langle body \rangle$  is being executed, the macros `\method` and `\attribute` are setup so that they can be used to define methods and attributes for this class (the original meanings are restored afterward).

The definition of a class is local to the scope where the class has been defined.

```
\pgfooclass{stamp}{
  % This is the class stamp

  \attribute text;
  \attribute rotation angle=20;

  \method stamp(#1) { % The constructor
    ...
  }

  \method apply(#1,#2) { % Causes the stamp to be shown at coordinate (#1,#2)
    ...
  }
}

% We can now create objects of type "stamp"
```

The  $\langle body \rangle$  of a class usually just consists of calls to the macros `\attribute` and `\method`, which will be discussed in more detail in later sections.

## 67.4 Objects

Once a class has been declared, we can start creating objects for this class. For this the `\pgfoonew` command can be used, which has a peculiar syntax:

`\pgfoonew` $\langle object\ handle\ or\ attribute \rangle$ =new  $\langle class\ name \rangle$ ( $\langle constructor\ arguments \rangle$ )

Causes a new object to be created. The class of the object will be  $\langle class\ name \rangle$ , which must previously have been declared using `\pgfooclass`. Once the object has been created, the constructor method of the object will be called with the parameter list set to  $\langle constructor\ arguments \rangle$ .

The resulting object is stored internally and its lifetime will end exactly at the end of the current scope. Here is an example in which three stamp objects are created.

```
\pgfoonew \firststamp = new stamp()
\pgfoonew \secondstamp = new stamp()
{
  \pgfoonew \thirdstamp = new stamp()
  ...
}
% \thirdstamp no longer exists, but \firststamp and \secondstamp do
% even if you try to store \thirdstamp in a global variable, trying
% to access it will result in an error.
```

The optional  $\langle object\ handle\ or\ attribute \rangle$  can either be an  $\langle object\ handle \rangle$  or an  $\langle attribute \rangle$ . When an  $\langle object\ handle \rangle$  is given, it must be a normal T<sub>E</sub>X macro name that will “point” to the object (handles are discussed in more detail in Section 67.7). You can use this macro to call methods of the object as discussed in the following section. When an  $\langle attribute \rangle$  is given, it must be given in curly braces (the curly braces are used to detect the presence of an attribute). In this case, a handle to the newly created object is stored in this attribute.

```

\pgfooclass{foo}
{
  \attribute stamp obj;
  \attribute another object;

  \method \foo() {
    \pgfoonew{stamp obj}=new stamp()
    \pgfoonew{another object}=new bar()
  }
  ...
}

```

### `\pgfoogc`

This command causes the “garbage collector” to be invoked. The job of this garbage collector is to free the global  $\TeX$ -macros that are used by “dead” objects (objects whose life-time has ended). This macro is called automatically after every scope in which an object has been created, so you normally do not need to call this macro yourself.

## 67.5 Methods

Methods are defined inside the body of classes using the following command:

`\method` $\langle$ *method name* $\rangle$  $\langle$ *parameter list* $\rangle$  $\{$ *method body* $\}$

This macro, which is only defined inside a class definition, defines a new method named  $\langle$ *method name* $\rangle$ . Just like class names, method names can contain spaces and other characters, so  $\langle$ *method names* $\rangle$  like `put_stamp_here` or `put stamp here` are both legal.

Three method names are special: First, a method having the same name as the class is called the *constructor* of the class. There must be such a method, even if its body is empty. There are (currently) no destructors; objects simply become “undefined” at the end of the scope in which they have been created. The other two methods are called `id` and `object`, which are always automatically defined and which you cannot redefine. They are discussed in Section 67.7.

Overloading of methods is not possible, that is, it is illegal to have two methods inside a single class with the same name (despite possibly different parameter lists). However, two different classes may contain a method with the same name, that is, classes form namespaces for methods.

The  $\langle$ *method name* $\rangle$  must be followed by a  $\langle$ *parameter list* $\rangle$  in parentheses, which must be present even when the  $\langle$ *parameter list* $\rangle$  is empty. The  $\langle$ *parameter list* $\rangle$  is actually a normal  $\TeX$  parameter list that will be matched against the parameters inside the parentheses upon method invocation and, thus, could be something like `#1#2 foo #3 bar .`, but a list like `#1,#2,#3` is more customary. By setting the parameter list to just `#1` and then calling, say, `\pgfkeys{#1}` at the beginning of a method, you can implement Objective-C-like named parameters.

When a method is called, the  $\langle$ *body* $\rangle$  of the method will be executed. The main difference to a normal macro is that while the  $\langle$ *body* $\rangle$  is executed a special macro called `\pgfoothis` is setup in such a way that it references that object for which the method is executed.

In order to call a method for an object, you first need to create the object and you need a handle for this object. In order to invoke a method for this object, a special syntax is used that is similar to Java or C++ syntax:

$\langle$ *object handle* $\rangle$ . $\langle$ *method name* $\rangle$  $\langle$ *parameters* $\rangle$

This causes the method  $\langle$ *method name* $\rangle$  to be called for the object referenced by the  $\langle$ *object handle* $\rangle$ . Naturally, the method is the one defined in the class of the object. The  $\langle$ *parameters* $\rangle$  are matched against the parameters of the method and, then, the method body is executed. The execution of the method body is *not* done inside a scope, so the effects of a method body persist.

```

\pgfooclass{stamp}{
  % This is the class stamp

  \method stamp() { % The constructor
  }

  \method apply(#1,#2) { % Causes the stamp to be shown at coordinate (#1,#2)
    % Draw the stamp:
    \node [rotate=20,font=\huge] at (#1,#2) {Passed};
  }
}

\pgfoonew \mystamp=new stamp()

\begin{tikzpicture}
  \mystamp.apply(1,2)
  \mystamp.apply(3,4)
\end{tikzpicture}

```

Inside a method, you can call other methods. If you have a handle for another object, you can simply call it in the manner described above. In order to call a method of the current object, you can use the special object handle `\pgfoothis`.

### `\pgfoothis`

This object handle is defined only when a method is being executed. There, it is then set to point to the object for which the method is being called, which allows you to call another method for the same object.

```

\pgfooclass{stamp}{
  % This is the class stamp

  \method stamp() {}

  \method apply(#1,#2) {
    \pgfoothis.shift origin(#1,#2)

    % Draw the stamp:
    \node [rotate=20,font=\huge] {Passed};
  }

  % Private method:
  \method shift origin(#1,#2) {
    \tikzset{xshift=#1,yshift=#2}
  }
}

```

## 67.6 Attributes

Every object has a set of attributes, which may change over time. Attributes are declared using the `\attribute` command, which, like the `\method` command, is defined only inside the scope of `\pgfooclass`. Attributes can be modified (only) by methods. To take the `stamp` example, an attribute of a `stamp` object might be the text that should be stamped when the `apply` method is called.

When an attribute is changed, this change is *not* local to the current `TEX` group. Changes will persist till the end of the object's life or until the attribute is changed once more.

To declare an attribute you should use the `\attribute` command:

```
\attribute<attribute name>=<initial value>;
```

This command can only be given inside the body of an `\pgfooclass` command. It declares the attribute named `<attribute name>`. This name, like method or class names, can be quite arbitrary, but should not contain periods. Valid names are `an_attribute?` or `my attribute`.

You can optionally specify an `<initial value>` for the attribute; if none is given, the empty string is used automatically. The initial value is the value that the attribute will have just after the object has been created and before the constructor is called.

```

\pgfooclass{stamp}{
  % This is the class stamp

  \attribute text;
  \attribute rotation angle = 20;

  \method stamp(#1) {
    \pgfooset{text}{#1} % Set the text
  }

  \method apply(#1,#2) {
    \pgfoothis.shift origin(#1,#2)

    % Draw the stamp:
    \node [rotate=\pgfoovalueof{rotation angle},font=\huge]
      {\pgfoovalueof{text}};
  }

  \method shift origin(#1,#2) { ... }

  \method set rotation (#1) {
    \pgfooset{rotation angle}{#1}
  }
}

```

Attributes can be set and read only inside methods, it is not possible to do so using an object handle. Spoken in terms of traditional object-oriented programming, attributes are always private. You need to define getter and setter methods if you wish to read or modify attributes.

Reading and writing attributes is not done using the “dot-notation” that is used for method calls. This is mostly due to efficiency reasons. Instead, a set of special macros is used, all of which can *only be used inside methods*.

**\pgfooset**{*<attribute>*}{*<value>*}

Sets the *<attribute>* of the current object to *<value>*.

```

\method set rotation (#1) {
  \pgfooset{rotation angle}{#1}
}

```

**\pgfoolet**{*<attribute>*}{*<macro>*}

Sets the *<attribute>* of the current value to the current value of *<macro>* using TeX’s \let command.

```

\method foo () {
  \pgfoolet{my func}\myfunc
  % Changing \myfunc now has no effect on the value of attribute my func
}

```

**\pgfoovalueof**{*<attribute>*}

Expands (eventually) to the current value of *<attribute>* of the current object.

```

\method apply(#1,#2) {
  \pgfoothis.shift origin(#1,#2)

  \node [rotate=\pgfoovalueof{rotation angle},font=\huge]
    {\pgfoovalueof{text}};
}

```

**\pgfooget**{*<attribute>*}{*<macro>*}

Reads the current value of *<attribute>* and stores the result in *<macro>*.

```

...
\method get rotation (#1) {
  \pgfooget{rotation angle}{#1}
}
...

\mystamp.get rotation(\therotation)
‘\therotation’ is now ‘20’ (or whatever).

```

## 67.7 Identities

Every object has a unique identity, which is simply an integer. It is possible to retrieve the object id using the `id` method (discussed below), but normally you will not need to do so because the id itself cannot be used to access an object. Rather, you access objects via their methods and these, in turn, can only be called via object handles.

Object handles can be created in four ways:

1. Calling `\pgfoonew⟨object handle⟩=...` will cause `⟨object handle⟩` to be a handle to the newly created object.
2. Using `\let` to create an alias of an existing object handle: If `\mystamp` is a handle, saying `\let\myotherstamp=\mystamp` creates a second handle to the same object.
3. `\pgfooobj{⟨id⟩}` can be used as an object handle to the object with the given `⟨id⟩`.
4. Using the `object` method to create a handle to a given object.

Let us have a look at the last two methods.

### `\pgfooobj{⟨id⟩}`

Provided that `⟨id⟩` is the id of an existing object (an object whose life-time has not expired), calling this command yields a handle to this object. The handle can then be used to call methods:

```
% Create a new object:
\pgfoonew \mystamp=new stamp()

% Get the object's id and store it in \myid:
\mystamp.get id(\myid)

% The following two calls have the same effect:
\mystamp.apply(1,1)
\pgfooobj{\myid}.apply(1,1)
```

The `id` method can be used to retrieve the id of an object. This method is predefined for every class and you should not try to define a method of this name yourself.

Method `get id(⟨macro⟩)` (predefined for all classes)

Calling `⟨obj⟩.get id(⟨macro⟩)` stores the id `⟨obj⟩` in `⟨macro⟩`. This is mainly useful when you wish to store an object for a longer time and you cannot guarantee that any handle that you happen to have for this object will be available later on.

The only way to use the retrieved id later on is to call `\pgfooobj`.

Different object that are alive (that are still within the scope in which they were created) will always have different ids, so you can use the id to test for equality of objects. However, after an object has been destroyed because its scope has ended the same id may be used again for newly created objects.

Here is a typical application where you need to call this method: You wish to collect a list of objects for which you wish to call a specific method from time to time. For the collection process you wish to offer a macro called `\addtoobjectlist`, which takes an object handle as parameter. It is quite easy to store this handle somewhere, but a handle is, well, just a handle. Typically, shortly after the call to `\addtoobjectlist` the handle will no longer be valid or even exist, even though the object still exists. In this case, you wish to store the object id somewhere instead of the handle. Thus, for the object passed to `\addtoobjectlist` you call the `id` method and store the resulting id, rather than the handle.

There is a second predefined methods, called `object`, which is also used to create object handles.

Method `get handle({⟨macro name⟩})` (predefined for all classes)

Calling this method for an object will cause `⟨macro name⟩` to become a handle to the given object. For any object handle `\obj` – other than `\pgfoothis` – the following two have the same effect:

1. `\let⟨macro name⟩=\obj`
2. `\obj.get handle(⟨macro name⟩)`

The first method is simpler and faster. However, for `\pgffoothis` there is a difference: The call `\pgffoothis.get handle(<macro name>)` will cause `<macro name>` to be an object handle to the current object and will persist to be so even after the method is done. By comparison, `\let<macro name>=\pgffoothis` causes `\obj` to be the same as the very special macro `\pgffoothis`, so `\obj` will always refer to the current object, which may change over time.

## 67.8 The Signal Class

The object-oriented module predefines, in addition to the basic mechanism for defining and using classes and object, one class: `signal`. This class implements a so-called signal-slot mechanism.

### Class `signal`

This class is used to implement a simple signal-slot mechanism. The idea is the following: From time to time special things happen about which a number of objects need to be informed. Different things can happen and different object will be interested in these things. A `signal` object can be used to signal that such special things of a certain kind have happend. For example, on signal object might be used to signal the event that “a page has been shipped out.” Another signal might be used to signal that “a figure is about to be typeset,” and so on.

Objects can “tune in” to signals. They do so by *connecting* one of their methods (then called a *slot*) to the signal. Then, whenever the signal is *emitted*, the method of the connected object(s) get called. Different objects can connect different slots to the same signal as long as the argument lists will fit. For example, the object that is used to signal the “end of page has been reached” might emit signals that have, say, the box number in which the finished page can be found as a parameter (actually, the finished page is always in box 255). Then one object could connect a method `handle page(#1)` to this signal, another might connad the method `emergency action(#1)` to this signal, and so on.

Currently, it is not possible to “unregister” or “detach” a slot from a signal, that is, once an object has been connect to a signal, it will continue to recieve emmissions of this signal till the end of the life-time of the signal. This is even true when the object no longer exists (but the signal does), so care must be taken that signal objects are always created before the objects that are listening to them.

### Constructor `signal()`

The constructor does nothing.

### Method `connect(<object handle>,<method name>)`

This method gets an `<object handle>` as parameter and a `<method name>` of this object. It will queue the object-method pair in an internal list and each time the signal emits something, this object’s method is called.

Be careful not to pass `\pgffoothis` as `<object handle>`. This would cause the signal object to connect to itself. Rather, if you wish to connect a signal to a method of the current object you first need to create an alias using the `object` method:

```
\pgfooclass{some class}{
  \method some class() {
    \pgffoothis.get handle(\me)
    \somesignal.connect(\me,foo)
    \anothersignal.connect(\me,bar)
  }
  \method foo () {}
  \method bar (#1,#2) {}
}
\pgfoonew \objA=new some class()
\pgfoonew \objB=new some class()
```

### Method `emit(<arguments>)`

This method emits a signal to all connected slots. This means that for all objects that have previously been connected via a call of `connect`, the method (slot) that was specified during the call of `connect` is invoked with given `<arguments>`.

```
\anothersignal.emit(1,2)
% will call \objA.bar(1,2) and \objB.bar(1,2)
```

## 67.9 Implementation Notes

For the curious, here are some notes on how the oo-system is implemented:

- There is an object id counter that gets incremented each time an object is created. However, this counter is local to the current scope, which means that it is reset at the end of each scope, corresponding to the fact that at the end of a scope all objects created in this scope become invalid. Newly created objects will then have the same id as “deleted” objects.
- Attributes are stored globally. For each attribute of each object there is a macro whose name is composed of the object’s id and the attribute name. Changes to object attributes are always global.
- Because of the object id reuse, attribute macros will be recycled in new scopes. However, this process is not perfect since the global macros storing old attributes of deleted objects will only be overwritten (and thereby freed) when a new object having the same attribute name is created for this id.
- When a method is called, before the method call some code is executed that sets a global counter storing the current object id to the object id of the object being called. After the method call some code is inserted that restores the global counter to its original value. This is done without scopes, so some tricky `\expandafter` magic is needed. Note that, because of this process, you cannot use commands like `\pgfutil@ifnextchar` at the end of a method.
- An object handle contains just the code to setup and restore the current object number to the number of the object being called.



# Part VIII

## The Basic Layer

by Till Tantau

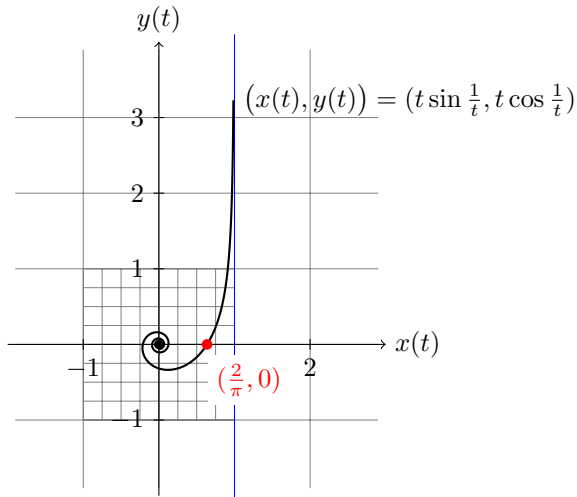

```
\begin{tikzpicture}
  \draw[gray,very thin] (-1.9,-1.9) grid (2.9,3.9)
    [step=0.25cm] (-1,-1) grid (1,1);
  \draw[blue] (1,-2.1) -- (1,4.1); % asymptote

  \draw[->] (-2,0) -- (3,0) node[right] {$x(t)$};
  \draw[->] (0,-2) -- (0,4) node[above] {$y(t)$};

  \foreach \pos in {-1,2}
    \draw[shift={(\pos,0)}] (0pt,2pt) -- (0pt,-2pt) node[below] {$\pos$};

  \foreach \pos in {-1,1,2,3}
    \draw[shift={(0,\pos)}] (2pt,0pt) -- (-2pt,0pt) node[left] {$\pos$};

  \fill (0,0) circle (0.064cm);
  \draw[thick,parametric,domain=0.4:1.5,samples=200]
    % The plot is reparameterised such that there are more samples
    % near the center.
    plot[id=asymptotic-example] function{(t*t*t)*sin(1/(t*t*t)),(t*t*t)*cos(1/(t*t*t))}
    node[right] {$\bigl(x(t),y(t)\bigr) = (t\sin \frac{1}{t}, t\cos \frac{1}{t})$};

  \fill[red] (0.63662,0) circle (2pt)
    node [below right,fill=white,yshift=-4pt] {$\frac{2}{\pi},0$};
\end{tikzpicture}
```

## 68 Design Principles

This section describes the basic layer of PGF. This layer is build on top of the system layer. Whereas the system layer just provides the absolute minimum for drawing graphics, the basic layer provides numerous commands that make it possible to create sophisticated graphics easily and also quickly.

The basic layer does not provide a convenient syntax for describing graphics, which is left to frontends like TikZ. For this reason, the basic layer is typically used only by “other programs.” For example, the BEAMER package uses the basic layer extensively, but does not need a convenient input syntax. Rather, speed and flexibility are needed when BEAMER creates graphics.

The following basic design principles underlie the basic layer:

1. Structuring into a core and modules.
2. Consistently named T<sub>E</sub>X macros for all graphics commands.
3. Path-centered description of graphics.
4. Coordinate transformation system.

### 68.1 Core and Modules

The basic layer consists of a *core package*, called `pgfcore`, which provides the most basic commands, and several *modules* like commands for plotting (in the `plot` module). Modules are loaded using the `\usepgfmodule` command.

If you say `\usepackage{pgf}` or `\input pgf.tex` or `\usemodule[pgf]`, the `plot` and `shapes` modules are preloaded (as well as the core and the system layer).

### 68.2 Communicating with the Basic Layer via Macros

In order to “communicate” with the basic layer you use long sequences of commands that start with `\pgf`. You are only allowed to give these commands inside a `{pgfpicture}` environment. (Note that `{tikzpicture}` opens a `{pgfpicture}` internally, so you can freely mix PGF commands and TikZ commands inside a `{tikzpicture}`.) It is possible to “do other things” between the commands. For example, you might use one command to move to a certain point, then have a complicated computation of the next point, and then move there.



```
\newdimen\myypos
\begin{pgfpicture}
  \pgfpathmoveto{\pgfpoint{0cm}{\myypos}}
  \pgfpathlineto{\pgfpoint{1cm}{\myypos}}
  \advance \myypos by 1cm
  \pgfpathlineto{\pgfpoint{1cm}{\myypos}}
  \pgfpathclose
  \pgfusepath{stroke}
\end{pgfpicture}
```

The following naming conventions are used in the basic layer:

1. All commands and environments start with `pgf`.
2. All commands that specify a point (a coordinate) start with `\pgfpoint`.
3. All commands that extend the current path start with `\pgfpath`.
4. All commands that set/change a graphics parameter start with `\pgfset`.
5. All commands that use a previously declared object (like a path, image or shading) start with `\pgfuse`.
6. All commands having to do with coordinate transformations start with `\pgftransform`.
7. All commands having to do with arrow tips start with `\pgfarrows`.
8. All commands for “quickly” extending or drawing a path start with `\pgfpathq` or `\pgfusepathq`.
9. All commands having to do with matrices start with `\pgfmatrix`.

### 68.3 Path-Centered Approach

In PGF the most important entity is the *path*. All graphics are composed of numerous paths that can be stroked, filled, shaded, or clipped against. Paths can be closed or open, they can self-intersect and consist of unconnected parts.

Paths are first *constructed* and then *used*. In order to construct a path, you can use commands starting with `\pgfpath`. Each time such a command is called, the current path is extended in some way.

Once a path has been completely constructed, you can use it using the command `\pgfusepath`. Depending on the parameters given to this command, the path will be stroked (drawn) or filled or subsequent drawings will be clipped against this path.

### 68.4 Coordinate Versus Canvas Transformations

PGF provides two transformation systems: PGF's own *coordinate* transformation matrix and PDF's or PostScript's *canvas* transformation matrix. These two systems are quite different. Whereas a scaling by a factor of, say, 2 of the canvas causes *everything* to be scaled by this factor (including the thickness of lines and text), a scaling of two in the coordinate system causes only the *coordinates* to be scaled, but not the line width nor text.

By default, all transformations only apply to the coordinate transformation system. However, using the command `\pgfsetlowlevel` it is possible to apply a transformation to the canvas.

Coordinate transformations are often preferable over canvas transformations. Text and lines that are transformed using canvas transformations suffer from differing sizes and lines whose thickness differs depending on whether the line is horizontal or vertical. To appreciate the difference, consider the following two “circles” both of which have been scaled in the *x*-direction by a factor of 3 and by a factor of 0.5 in the *y*-direction. The left circle uses a canvas transformation, the right uses PGF's coordinate transformation (some viewers will render the left graphic incorrectly since they do not apply the low-level transformation the way they should):



## 69 Hierarchical Structures: Package, Environments, Scopes, and Text

### 69.1 Overview

PGF uses two kinds of hierarchical structuring: First, the package itself is structured hierarchically, consisting of different packages that are built on top of each other. Second, PGF allows you to structure your graphics hierarchically using environments and scopes.

#### 69.1.1 The Hierarchical Structure of the Package

The PGF system consists of several layers:

**System layer.** The lowest layer is called the *system layer*, though it might also be called “driver layer” or perhaps “backend layer.” Its job is to provide an abstraction of the details of which driver is used to transform the `.dvi` file. The system layer is implemented by the package `pgfsys`, which will load appropriate driver files as needed.

The system layer is documented in Part IX.

**Basic layer.** The basic layer is loaded by the package `pgfcore` and subsequent use of the command `\usepgfmodule` to load additional modules of the basic layer.

The basic layer is documented in the present part.

**Frontend layer.** The frontend layer is not loaded by a single package. Rather, different packages, like `TikZ` or `PGFPIC2E`, are different frontends to the basic layer.

The `TikZ` frontend is documented in Part III.

Each layer will automatically load the necessary files of the layers below it.

In addition to the packages of these layers, there are also some library packages. These packages provide additional definitions of things like new arrow tips or new plot handlers.

The library packages are documented in Part IV.

#### 69.1.2 The Hierarchical Structure of Graphics

Graphics in PGF are typically structured hierarchically. Hierarchical structuring can be used to identify groups of graphical elements that are to be treated “in the same way.” For example, you might group together a number of paths, all of which are to be drawn in red. Then, when you decide later on that you like them to be drawn in, say, blue, all you have to do is to change the color once.

The general mechanism underlying hierarchical structuring is known as *scoping* in computer science. The idea is that all changes to the general “state” of the graphic that are done inside a scope are local to that scope. So, if you change the color inside a scope, this does not affect the color used outside the scope. Likewise, when you change the line width in a scope, the line width outside is not changed, and so on.

There are different ways of starting and ending scopes of graphic parameters. Unfortunately, these scopes are sometimes “in conflict” with each other and it is sometimes not immediately clear which scopes apply. In essence, the following scoping mechanisms are available:

1. The “outermost” scope supported by PGF is the `{pgfpicture}` environment. All changes to the graphic state done inside a `{pgfpicture}` are local to that picture.

In general, it is *not* possible to set graphic parameters globally outside any `{pgfpicture}` environments. Thus, you can *not* say `\pgfsetlinewidth{1pt}` at the beginning of your document to have a default line width of one point. Rather, you have to (re)set all graphic parameters inside each `{pgfpicture}`. (If this is too bothersome, try defining some macro that does the job for you.)

2. Inside a `{pgfpicture}` you can use a `{pgfscope}` environment to keep changes of the graphic state local to that environment.

The effect of commands that change the graphic state are local to the current `{pgfscope}` but not always to the current `TEX` group. Thus, if you open a `TEX` group (some text in curly braces) inside a `{pgfscope}`, and if you change, for example, the dash pattern, the effect of this changed dash pattern will persist till the end of the `{pgfscope}`.

Unfortunately, this is not always the case. *Some* graphic parameters only persist till the end of the current  $\TeX$  group. For example, when you use `\pgfsetarrows` to set the arrow tip inside a  $\TeX$  group, the effect lasts only till the end of the current  $\TeX$  group.

3. Some graphic parameters are not scoped by `{pgfscope}` but “already” by  $\TeX$  groups. For example, the effect of coordinate transformation commands is always local to the current  $\TeX$  group.

Since every `{pgfscope}` automatically creates a  $\TeX$  group, all graphic parameters that are local to the current  $\TeX$  group are also local to the current `{pgfscope}`.

4. Some graphic parameters can only be scoped using  $\TeX$  groups, since in some situations it is not possible to introduce a `{pgfscope}`. For example, a path always has to be completely constructed and used in the same `{pgfscope}`. However, we might wish to have different coordinate transformations apply to different points on the path. In this case, we can use  $\TeX$  groups to keep the effect local, but we could not use `{pgfscope}`.
5. The `\pgftext` command can be used to create a scope in which  $\TeX$  “escapes back” to normal  $\TeX$  mode. The text passed to the `\pgftext` is “heavily guarded” against having any effect on the scope in which it is used. For example, it is possible to use another `{pgfpicture}` environment inside the argument of `\pgftext`.

Most of the complications can be avoided if you stick to the following rules:

- Give graphic commands only inside `{pgfpicture}` environments.
- Use `{pgfscope}` to structure graphics.
- Do not use  $\TeX$  groups inside graphics, *except* for keeping the effect of coordinate transformations local.

## 69.2 The Hierarchical Structure of the Package

Before we come to the structuring commands provided by PGF to structure your graphics, let us first have a look at the structure of the package itself.

### 69.2.1 The Core Package

To use PGF, include the following package:

```
\usepackage{pgfcore} %  $\LaTeX$ 
\input pgfcore.tex % plain  $\TeX$ 
\usemodule[pgfcore] % Con $\TeX$ t
```

This package loads the complete core of the “basic layer” of PGF, but not any modules. That is, it will load all of the commands described in the current part of this manual, but it will not load frontends like TikZ. It will also load the system layer. To load additional modules, use the `\usepgfmodule` command explained below.

The following package is just a convenience.

```
\usepackage{pgf} %  $\LaTeX$ 
\input pgf.tex % plain  $\TeX$ 
\usemodule[pgf] % Con $\TeX$ t
```

This package loads the `pgfcore` and the two modules `shapes` and `plot`.

In  $\LaTeX$ , the package takes two options:

```
\usepackage[draft]{pgf}
```

When this option is set, all images will be replaced by empty rectangles. This can speedup compilation.

```
\usepackage[version=<version>]{pgf}
```

Indicates that the commands of version `<version>` need to be defined. If you set `<version>` to `0.65`, then a large bunch of “compatibility commands” are loaded. If you set `<version>` to `0.96`, then these compatibility commands will not be loaded.

If this option is not given at all, then the commands of all versions are defined.

## 69.2.2 The Modules

`\usepgflibrary{⟨module names⟩}`

Once the core has been loaded, you can use this command to load further modules. The modules in the `⟨module names⟩` list should be separated by commas. Instead of curly braces, you can also use square brackets, which is something ConT<sub>E</sub>Xt users will like. If you try to load a module a second time, nothing will happen.

*Example:* `\usepgfmodule{matrix,shapes}`

What this command does is to load the file `pgfmodule⟨module⟩.code.tex` for each `⟨module⟩` in the `⟨module names⟩`. Thus, to write your own module, all you need to do is to place a file of the appropriate name somewhere where T<sub>E</sub>X can find it. L<sup>A</sup>T<sub>E</sub>X, plain T<sub>E</sub>X, and ConT<sub>E</sub>Xt users can then use your library.

The following modules are available for use with `pgfcore`:

- The `plot` module provides commands for plotting functions. The commands are explained in Section 81.
- The `shapes` module provides commands for drawing shapes and nodes. These commands are explained in Section 75.
- The `decorations` module provides commands for adding decorations to paths. These commands are explained in Section 72.
- The `matrix` module provides the `\pgfmatrix` command. The commands are documented in Section 76.

## 69.2.3 The Library Packages

There is a special command for loading library packages. The difference between a library and module is the following: A library just defines additional objects using the basic layer, whereas a module adds completely new functionality. For instance, a decoration library defines additional decorations, while a decoration module defines the whole code for handling decorations.

`\usepgflibrary{⟨list of libraries⟩}`

Use this command to load further libraries. The list of libraries should contain the names of libraries separated by commas. Instead of curly braces, you can also use square brackets. If you try to load a library a second time, nothing will happen.

*Example:* `\usepgflibrary{arrows}`

This command causes the the file `pgflibrary⟨library⟩.code.tex` to be loaded for each `⟨library⟩` in the `⟨list of libraries⟩`. This means that in order to write your own library file, place a file of the appropriate name somewhere where T<sub>E</sub>X can find it. L<sup>A</sup>T<sub>E</sub>X, plain T<sub>E</sub>X, and ConT<sub>E</sub>Xt users can then use your library.

You should also consider adding a TikZ library that simply includes your PGF library.

## 69.3 The Hierarchical Structure of the Graphics

### 69.3.1 The Main Environment

Most, but not all, commands of the PGF package must be given within a `{pgfpicture}` environment. The only commands that (must) be given outside are commands having to do with including images (like `\pgfuseimage`) and with inserting complete shadings (like `\pgfuseshading`). However, just to keep life entertaining, the `\pgfshadepath` command must be given *inside* a `{pgfpicture}` environment.

```
\begin{pgfpicture}
  ⟨environment contents⟩
\end{pgfpicture}
```

This environment will insert a T<sub>E</sub>X box containing the graphic drawn by the `⟨environment contents⟩` at the current position.



**The size of the bounding box.** The size of the box is determined in the following manner: While PGF parses the *environment contents*, it keeps track of a bounding box for the graphic. Essentially, this bounding box is the smallest box that contains all coordinates mentioned in the graphics. Some coordinates may be “mentioned” by PGF itself; for example, when you add circle to the current path, the support points of the curve making up the circle are also “mentioned” despite the fact that you will not “see” them in your code.

Once the *environment contents* has been parsed completely, a T<sub>E</sub>X box is created whose size is the size of the computed bounding box and this box is inserted at the current position.



|                                                                                                |                                                                                                                                             |
|------------------------------------------------------------------------------------------------|---------------------------------------------------------------------------------------------------------------------------------------------|
| Hello  World! | <pre>Hello \begin{pgfpicture}   \pgfpathrectangle{\pgfpointorigin}{\pgfpoint{2ex}{1ex}}   \pgfusepath{stroke} \end{pgfpicture} World!</pre> |
|------------------------------------------------------------------------------------------------|---------------------------------------------------------------------------------------------------------------------------------------------|

Sometimes, you may need more fine-grained control over the size of the bounding box. For example, the computed bounding box may be too large or you intensionally wish the box to be “too small.” In these cases, you can use the command `\pgfusepath{use as bounding box}`, as described in Section 73.5.

**The baseline of the bounding box.** When the box containing the graphic is inserted into the normal text, the baseline of the graphic is normally at the bottom of the graphic. For this reason, the following two sets of code lines have the same effect, despite the fact that the second graphic uses “higher” coordinates than the first:

|                                                                                                                                                                                      |                                                                                                                                                                                                                                                                        |
|--------------------------------------------------------------------------------------------------------------------------------------------------------------------------------------|------------------------------------------------------------------------------------------------------------------------------------------------------------------------------------------------------------------------------------------------------------------------|
| Rectangles  and  . | <pre>Rectangles \begin{pgfpicture}   \pgfpathrectangle{\pgfpointorigin}{\pgfpoint{2ex}{1ex}}   \pgfusepath{stroke} \end{pgfpicture} and \begin{pgfpicture}   \pgfpathrectangle{\pgfpoint{0ex}{1ex}}{\pgfpoint{2ex}{1ex}}   \pgfusepath{stroke} \end{pgfpicture}.</pre> |
|--------------------------------------------------------------------------------------------------------------------------------------------------------------------------------------|------------------------------------------------------------------------------------------------------------------------------------------------------------------------------------------------------------------------------------------------------------------------|

You can change the baseline using the `\pgfsetbaseline` command, see below.

|                                                                                                                                                                                          |                                                                                                                                                                                                                                                                                                                      |
|------------------------------------------------------------------------------------------------------------------------------------------------------------------------------------------|----------------------------------------------------------------------------------------------------------------------------------------------------------------------------------------------------------------------------------------------------------------------------------------------------------------------|
| Rectangles  and  . | <pre>Rectangles \begin{pgfpicture}   \pgfpathrectangle{\pgfpointorigin}{\pgfpoint{2ex}{1ex}}   \pgfusepath{stroke}   \pgfsetbaseline{0pt} \end{pgfpicture} and \begin{pgfpicture}   \pgfpathrectangle{\pgfpoint{0ex}{1ex}}{\pgfpoint{2ex}{1ex}}   \pgfusepath{stroke}   \pgfsetbaseline{0pt} \end{pgfpicture}.</pre> |
|------------------------------------------------------------------------------------------------------------------------------------------------------------------------------------------|----------------------------------------------------------------------------------------------------------------------------------------------------------------------------------------------------------------------------------------------------------------------------------------------------------------------|

**Including text and images in a picture.** You cannot directly include text and images in a picture. Thus, you should *not* simply write some text in a `{pgfpicture}` or use a command like `\includegraphics` or even `\pgfimage`. In all these cases, you need to place the text inside a `\pgftext` command. This will “escape back” to normal T<sub>E</sub>X mode, see Section 69.3.3 for details.

**Remembering a picture position for later reference.** After a picture has been typeset, its position on the page is normally forgotten by PGF and also by T<sub>E</sub>X. This means that it is not possible to reference a node in this picture later on. In particular, it is normally impossible to draw lines between nodes in different pictures automatically.

In order to make PGF “remember” a picture, the T<sub>E</sub>X-if `\ifpgfrememberpicturepositiononpage` should be set to `true`. It is only important that this T<sub>E</sub>X-if is `true` at the end of the `{pgfpicture}`-environment, so you can switch it on inside the environment. However, you can also just switch it on globally, then the positions of all pictures are remembered.

There are several reasons why the remembering is not switched on by default. First, it does not work for all backend drivers (currently, it works only for pdfT<sub>E</sub>X). Second, it requires two passes of T<sub>E</sub>X over the file; on the first pass all positions will be wrong. Third, for every remembered picture a line is added to the `.aux`-file, which may result in a large number of extra lines.

Despite all these “problems,” for documents that are processed with pdfT<sub>E</sub>X and in which there is only a small number of pictures (less than a hundred or so), you can switch on this option globally, it will not cause any significant slowing of T<sub>E</sub>X.

**\pgfpicture**  
*<environment contents>*  
**\endpgfpicture**

The plain T<sub>E</sub>X version of the environment. Note that in this version, also, a T<sub>E</sub>X group is created around the environment.

**\startpgfpicture**  
*<environment contents>*  
**\stoppgfpicture**

This is the ConT<sub>E</sub>Xt version of the environment.

**\ifpgfrememberpicturepositiononpage**

Determines whether the position of pictures on the page should be recorded. The value of this T<sub>E</sub>X-if at the end of a {pgfpicture} environment is important, not the value at the beginning.

If this option is set to true of a picture, PGF will attempt to record the position of the picture on the page. (This attempt will fail with most drivers and when it works it typically requires two runs of T<sub>E</sub>X.) The position is not directly accessible. Rather, the nodes mechanism will use this position if you access a node from another picture. See Sections 75.3.2 and 16.13 for more details.

**\pgfsetbaseline{<dimension>}**

This command specifies a *y*-coordinate of the picture that should be used as the baseline of the whole picture. When a PGF picture has been typeset completely, PGF must decide at which height the baseline of the picture should lie. Normally, the baseline is set to the *y*-coordinate of the bottom of the picture, but it is often desirable to use another height.

Text ○, ○, ○, ○.

```
Text \tikz{\pgfpathcircle{\pgfpointorigin}{1ex}\pgfusepath{stroke}},
\tikz{\pgfsetbaseline{0pt}
\pgfpathcircle{\pgfpointorigin}{1ex}\pgfusepath{stroke}},
\tikz{\pgfsetbaseline{.5ex}
\pgfpathcircle{\pgfpointorigin}{1ex}\pgfusepath{stroke}},
\tikz{\pgfsetbaseline{-1ex}
\pgfpathcircle{\pgfpointorigin}{1ex}\pgfusepath{stroke}}.
```

**\pgfsetbaselinepointnow{<point>}**

This command specifies the baseline indirectly, namely as the *y*-coordinate that the given *<point>* has when the command is called.

**\pgfsetbaselinepointlater{<point>}**

This command also specifies the baseline indirectly, but the *y*-coordinate of the given *<point>* is only computed at the end of the picture.

Hello ~~world.~~

```
Hello
\tikz{
\pgfsetbaselinepointlater{\pgfpointanchor{X}{base}}
% Note: no shape X, yet
\node [cross out,draw] (X) {world.};
}
```

### 69.3.2 Graphic Scope Environments

Inside a {pgfpicture} environment you can substructure your picture using the following environment:

**\begin{pgfscope}**  
*<environment contents>*  
**\end{pgfscope}**

All changes to the graphic state done inside this environment are local to the environment. The graphic state includes the following:

- The line width.
- The stroke and fill colors.



- The dash pattern.
- The line join and cap.
- The miter limit.
- The canvas transformation matrix.
- The clipping path.

Other parameters may also influence how graphics are rendered, but they are *not* part of the graphic state. For example, the arrow tip kind is not part of the graphic state and the effect of commands setting the arrow tip kind are local to the current T<sub>E</sub>X group, not to the current `{pgfscope}`. However, since `{pgfscope}` starts and ends a T<sub>E</sub>X group automatically, a `{pgfscope}` can be used to limit the effect of, say, commands that set the arrow tip kind.



```
\begin{pgfpicture}
\begin{pgfscope}
{
\pgfsetlinewidth{2pt}
\pgfpathrectangle{\pgfpointorigin}{\pgfpoint{2ex}{2ex}}
\pgfusepath{stroke}
}
\pgfpathrectangle{\pgfpoint{3ex}{0ex}}{\pgfpoint{2ex}{2ex}}
\pgfusepath{stroke}
\end{pgfscope}
\pgfpathrectangle{\pgfpoint{6ex}{0ex}}{\pgfpoint{2ex}{2ex}}
\pgfusepath{stroke}
\end{pgfpicture}
```

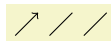

```
\begin{pgfpicture}
\begin{pgfscope}
{
\pgfsetarrows{-to}
\pgfpathmoveto{\pgfpointorigin}\pgfpathlineto{\pgfpoint{2ex}{2ex}}
\pgfusepath{stroke}
}
\pgfpathmoveto{\pgfpoint{3ex}{0ex}}\pgfpathlineto{\pgfpoint{5ex}{2ex}}
\pgfusepath{stroke}
\end{pgfscope}
\pgfpathmoveto{\pgfpoint{6ex}{0ex}}\pgfpathlineto{\pgfpoint{8ex}{2ex}}
\pgfusepath{stroke}
\end{pgfpicture}
```

At the start of the scope, the current path must be empty, that is, you cannot open a scope while constructing a path.

It is usually a good idea *not* to introduce T<sub>E</sub>X groups inside a `{pgfscope}` environment.

**`\pgfscope`**  
*<environment contents>*

**`\endpgfscope`**

Plain T<sub>E</sub>X version of the `{pgfscope}` environment.

**`\startpgfscope`**  
*<environment contents>*

**`\stoppgfscope`**

This is the ConT<sub>E</sub>Xt version of the environment.

The following scopes also encapsulate certain properties of the graphic state. However, they are typically not used directly by the user.

**`\begin{pgfinterruptpath}`**  
*<environment contents>*

**`\end{pgfinterruptpath}`**

This environment can be used to temporarily interrupt the construction of the current path. The effect will be that the path currently under construction will be “stored away” and restored at the end of the environment. Inside the environment you can construct a new path and do something with it.

An example application of this environment is the arrow tip caching. Suppose you ask PGF to use a specific arrow tip kind. When the arrow tip needs to be rendered for the first time, PGF will “cache” the path that makes up the arrow tip. To do so, it interrupts the current path construction and then protocols the path of the arrow tip. The `{pgfinterruptpath}` environment is used to ensure that this does not interfere with the path to which the arrow tips should be attached.

This command does *not* install a `{pgfscope}`. In particular, it does not call any `\pgfsys@` commands at all, which would, indeed, be dangerous in the middle of a path construction.

`\pgfinterruptpath`  
*<environment contents>*  
`\endpgfinterruptpath`

Plain T<sub>E</sub>X version of the environment.

`\startpgfinterruptpath`  
*<environment contents>*  
`\stoppgfinterruptpath`

ConT<sub>E</sub>Xt version of the environment.

`\begin{pgfinterruptpicture}`  
*<environment contents>*  
`\end{pgfinterruptpicture}`

This environment can be used to temporarily interrupt a `{pgfpicture}`. However, the environment is intended only to be used at the beginning and end of a box that is (later) inserted into a `{pgfpicture}` using `\pgfqbox`. You cannot use this environment directly inside a `{pgfpicture}`.

Sub-picture.

```
\begin{pgfpicture}
  \pgfpathmoveto{\pgfpoint{0cm}{0cm}} % In the middle of path, now
  \newbox\mybox
  \setbox\mybox=\hbox{
    \begin{pgfinterruptpicture}
      Sub-\begin{pgfpicture} % a subpicture
        \pgfpathmoveto{\pgfpoint{1cm}{0cm}}
        \pgfpathlineto{\pgfpoint{1cm}{1cm}}
        \pgfusepath{stroke}
      \end{pgfinterruptpicture}
    \end{pgfpicture}-picture.
  }
  \pgfqbox{\mybox}%
  \pgfpathlineto{\pgfpoint{0cm}{1cm}}
  \pgfusepath{stroke}
\end{pgfpicture}\hskip3.9cm
```

`\pgfinterruptpicture`  
*<environment contents>*  
`\endpgfinterruptpicture`

Plain T<sub>E</sub>X version of the environment.

`\startpgfinterruptpicture`  
*<environment contents>*  
`\stoppgfinterruptpicture`

ConT<sub>E</sub>Xt version of the environment.

`\begin{pgfinterruptboundingbox}`  
*<environment contents>*  
`\end{pgfinterruptboundingbox}`

This environment temporarily interrupts the computation of the bounding box and sets up a new bounding box. At the beginning of the environment the old bounding box is saved and an empty bounding box is installed. After the environment the original bounding box is reinstalled as if nothing has happened.

`\pgfinterruptboundingbox`

*<environment contents>*

`\endpgfinterruptboundingbox`

Plain T<sub>E</sub>X version of the environment.

`\startpgfinterruptboundingbox`

*<environment contents>*

`\stoppgfinterruptboundingbox`

ConT<sub>E</sub>Xt version of the environment.

### 69.3.3 Inserting Text and Images

Often, you may wish to add normal T<sub>E</sub>X text at a certain point inside a `{pgfpicture}`. You cannot do so “directly,” that is, you cannot simply write this text inside the `{pgfpicture}` environment. Rather, you must pass the text as an argument to the `\pgftext` command.

You must *also* use the `\pgftext` command to insert an image or a shading into a `{pgfpicture}`.

`\pgftext[<options>]{<text>}`

This command will typeset *<text>* in normal T<sub>E</sub>X mode and insert the resulting box into the `{pgfpicture}`. The bounding box of the graphic will be updated so that all of the text box is inside. By default, the text box is centered at the origin, but this can be changed either by giving appropriate *<options>* or by applying an appropriate coordinate transformation beforehand.

The *<text>* may contain verbatim text. (In other words, the *<text>* “argument” is not a normal argument, but is put in a box and some `\aftergroup` hackery is used to find the end of the box.)

PGF’s current (high-level) coordinate transformation is synchronized with the canvas transformation matrix temporarily when the text box is inserted. The effect is that if there is currently a high-level rotation of, say, 30 degrees, the *<text>* will also be rotated by thirty degrees. If you do not want this effect, you have to (possibly temporarily) reset the high-level transformation matrix.

The *<options>* keys are used with the path `/pgf/text/`. The following keys are defined for this path:

`/pgf/text/left` (no value)

The key causes the text box to be placed such that its left border is on the origin.

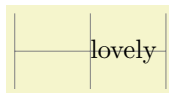

```
\tikz{\draw[help lines] (-1,-.5) grid (1,.5);
\pgftext[left] {lovely}}
```

`/pgf/text/right` (no value)

This key causes the text box to be placed such that its right border is on the origin.

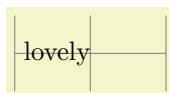

```
\tikz{\draw[help lines] (-1,-.5) grid (1,.5);
\pgftext[right] {lovely}}
```

`/pgf/text/top` (no value)

This key causes the text box to be placed such that its top is on the origin. This option can be used together with the `left` or `right` option.



```
\tikz{\draw[help lines] (-1,-.5) grid (1,.5);
\pgftext[top] {lovely}}
```

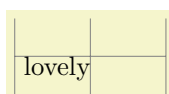

```
\tikz{\draw[help lines] (-1,-.5) grid (1,.5);
\pgftext[top,right] {lovely}}
```

**/pgf/text/bottom**

(no value)

This key causes the text box to be placed such that its bottom is on the origin.

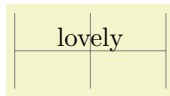

```
\tikz{\draw[help lines] (-1,-.5) grid (1,.5);
\pgftext[bottom] {lovely}}
```

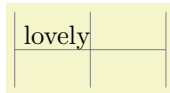

```
\tikz{\draw[help lines] (-1,-.5) grid (1,.5);
\pgftext[bottom,right] {lovely}}
```

**/pgf/text/base**

(no value)

This key causes the text box to be placed such that its baseline is on the origin.



```
\tikz{\draw[help lines] (-1,-.5) grid (1,.5);
\pgftext[base] {lovely}}
```



```
\tikz{\draw[help lines] (-1,-.5) grid (1,.5);
\pgftext[base,right] {lovely}}
```

**/pgf/text/at=<point>**

(no default)

Translates the origin (that is, the point where the text is shown) to *<point>*.

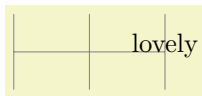

```
\tikz{\draw[help lines] (-1,-.5) grid (1,.5);
\pgftext[base,at={\pgfpoint{1cm}{0cm}}] {lovely}}
```

**/pgf/text/x=<dimension>**

(no default)

Translates the origin by *<dimension>* along the *x*-axis.

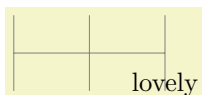

```
\tikz{\draw[help lines] (-1,-.5) grid (1,.5);
\pgftext[base,x=1cm,y=-0.5cm] {lovely}}
```

**/pgf/text/y=<dimension>**

(no default)

This key works like the *x* option.

**/pgf/text/rotate=<degree>**

(no default)

Rotates the coordinate system by *<degree>*. This will also rotate the text box.

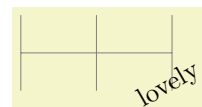

```
\tikz{\draw[help lines] (-1,-.5) grid (1,.5);
\pgftext[base,x=1cm,y=-0.5cm,rotate=30] {lovely}}
```

## 70 Specifying Coordinates

### 70.1 Overview

Most PGF commands expect you to provide the coordinates of a *point* (also called *coordinate*) inside your picture. Points are always “local” to your picture, that is, they never refer to an absolute position on the page, but to a position inside the current `{pgfpicture}` environment. To specify a coordinate you can use commands that start with `\pgfpoint`.

### 70.2 Basic Coordinate Commands

The following commands are the most basic for specifying a coordinate.

`\pgfpoint{⟨x coordinate⟩}{⟨y coordinate⟩}`

Yields a point location. The coordinates are given as T<sub>E</sub>X dimensions.

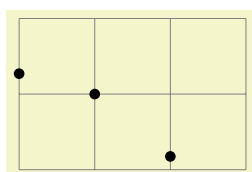

```
\begin{tikzpicture}
\draw[help lines] (0,0) grid (3,2);
\pgfpathcircle{\pgfpoint{1cm}{1cm}} {2pt}
\pgfpathcircle{\pgfpoint{2cm}{5pt}} {2pt}
\pgfpathcircle{\pgfpoint{0pt}{.5in}}{2pt}
\pgfusepath{fill}
\end{tikzpicture}
```

`\pgfpointorigin`

Yields the origin. Same as `\pgfpoint{0pt}{0pt}`.

`\pgfpointpolar{⟨degree⟩}{⟨radius⟩/⟨y-radius⟩}`

Yields a point location given in polar coordinates. You can specify the angle only in degrees, radians are not supported, currently.

If the optional `⟨y-radius⟩` is given, the polar coordinate is actually a coordinate on an ellipse whose *x*-radius is given by `⟨radius⟩` and whose *y*-radius is given by `⟨y-radius⟩`.

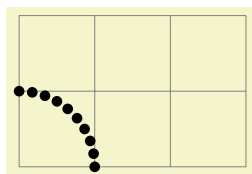

```
\begin{tikzpicture}
\draw[help lines] (0,0) grid (3,2);

\foreach \angle in {0,10,...,90}
{\pgfpathcircle{\pgfpointpolar{\angle}{1cm}}{2pt}}
\pgfusepath{fill}
\end{tikzpicture}
```

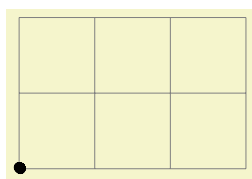

```
\begin{tikzpicture}
\draw[help lines] (0,0) grid (3,2);

\foreach \angle in {0,10,...,90}
{\pgfpathcircle{\pgfpointpolar{\angle}{1cm/2cm}}{2pt}}
\pgfusepath{fill}
\end{tikzpicture}
```

### 70.3 Coordinates in the XY-Coordinate System

Coordinates can also be specified as multiples of an *x*-vector and a *y*-vector. Normally, the *x*-vector points one centimeter in the *x*-direction and the *y*-vector points one centimeter in the *y*-direction, but using the commands `\pgfsetxvec` and `\pgfsetyvec` they can be changed. Note that the *x*- and *y*-vector do not necessarily point “horizontally” and “vertically.”

`\pgfpointxy{⟨sx⟩}{⟨sy⟩}`

Yields a point that is situated at  $s_x$  times the *x*-vector plus  $s_y$  times the *y*-vector.

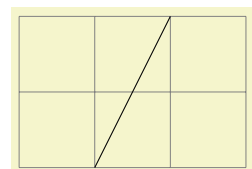

```
\begin{tikzpicture}
\draw[help lines] (0,0) grid (3,2);
\pgfpathmoveto{\pgfpointxy{1}{0}}
\pgfpathlineto{\pgfpointxy{2}{2}}
\pgfusepath{stroke}
\end{tikzpicture}
```

`\pgfsetxvec{⟨point⟩}`

Sets that current  $x$ -vector for usage in the  $xyz$ -coordinate system.

Example:

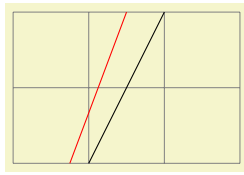

```
\begin{tikzpicture}
  \draw[help lines] (0,0) grid (3,2);

  \pgfpathmoveto{\pgfpointxy{1}{0}}
  \pgfpathlineto{\pgfpointxy{2}{2}}
  \pgfusepath{stroke}

  \color{red}
  \pgfsetxvec{\pgfpoint{0.75cm}{0cm}}
  \pgfpathmoveto{\pgfpointxy{1}{0}}
  \pgfpathlineto{\pgfpointxy{2}{2}}
  \pgfusepath{stroke}
\end{tikzpicture}
```

`\pgfsetyvec{⟨point⟩}`

Works like `\pgfsetxvec`.

`\pgfpointpolarxy{⟨degree⟩}{⟨radius⟩/⟨y-radius⟩}`

This command is similar to the `\pgfpointpolar` command, but the  $\langle radius \rangle$  is now a factor to be interpreted in the  $xy$ -coordinate system. This means that a degree of 0 is the same as the  $x$ -vector of the  $xy$ -coordinate system times  $\langle radius \rangle$  and a degree of 90 is the  $y$ -vector times  $\langle radius \rangle$ . As for `\pgfpointpolar`, a  $\langle radius \rangle$  can also be a pair separated by a slash. In this case, the  $x$ - and  $y$ -vectors are multiplied by different factors.

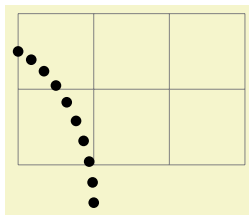

```
\begin{tikzpicture}
  \draw[help lines] (0,0) grid (3,2);

  \begin{scope}[x={(1cm,-5mm)},y=1.5cm]
    \foreach \angle in {0,10,...,90}
      {\pgfpathcircle{\pgfpointpolarxy{\angle}{1}}{2pt}}
    \pgfusepath{fill}
  \end{scope}
\end{tikzpicture}
```

## 70.4 Three Dimensional Coordinates

It is also possible to specify a point as a multiple of three vectors, the  $x$ -,  $y$ -, and  $z$ -vector. This is useful for creating simple three dimensional graphics.

`\pgfpointxyz{⟨sx⟩}{⟨sy⟩}{⟨sz⟩}`

Yields a point that is situated at  $s_x$  times the  $x$ -vector plus  $s_y$  times the  $y$ -vector plus  $s_z$  times the  $z$ -vector.

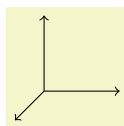

```
\begin{pgfpicture}
  \pgfsetarrowsend{to}

  \pgfpathmoveto{\pgfpointorigin}
  \pgfpathlineto{\pgfpointxyz{0}{0}{1}}
  \pgfusepath{stroke}
  \pgfpathmoveto{\pgfpointorigin}
  \pgfpathlineto{\pgfpointxyz{0}{1}{0}}
  \pgfusepath{stroke}
  \pgfpathmoveto{\pgfpointorigin}
  \pgfpathlineto{\pgfpointxyz{1}{0}{0}}
  \pgfusepath{stroke}
\end{pgfpicture}
```

`\pgfsetzvec{⟨point⟩}`

Works like `\pgfsetxvec`.

Inside the  $xyz$ -coordinate system, you can also specify points using spherical and cylindrical coordinates.

`\pgfpointcylindrical{<degree>}{<radius>}{<height>}`

This command yields the same as

`\pgfpointadd{\pgfpointpolarxy{<degree>}{<radius>}}{\pgfpointxyz{0}{0}{<height>}}`

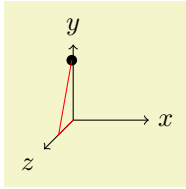

```
\begin{tikzpicture}
\draw [->] (0,0) -- (1,0,0) node [right] {$x$};
\draw [->] (0,0) -- (0,1,0) node [above] {$y$};
\draw [->] (0,0) -- (0,0,1) node [below left] {$z$};

\pgfpathcircle{\pgfpointcylindrical{80}{1}{.5}}{2pt}
\pgfusepath{fill}

\draw[red] (0,0) -- (0,0,.5) -- +(80:1);
\end{tikzpicture}
```

`\pgfpointsspherical{<longitude>}{<latitude>}{<radius>}`

This command yields a point “on the surface of the earth” specified by the  $\langle longitude \rangle$  and the  $\langle latitude \rangle$ . The radius of the earth is given by  $\langle radius \rangle$ . The equator lies in the  $xy$ -plane.

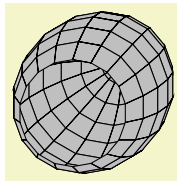

```
\begin{tikzpicture}
\pgfsetfillcolor{lightgray}

\foreach \latitude in {-90,-75,...,30}
{
\foreach \longitude in {0,20,...,360}
{
\pgfpathmoveto{\pgfpointsspherical{\longitude}{\latitude}{1}}
\pgfpathlineto{\pgfpointsspherical{\longitude+20}{\latitude}{1}}
\pgfpathlineto{\pgfpointsspherical{\longitude+20}{\latitude+15}{1}}
\pgfpathlineto{\pgfpointsspherical{\longitude}{\latitude+15}{1}}
\pgfpathclose
}
\pgfusepath{fill,stroke}
}
\end{tikzpicture}
```

## 70.5 Building Coordinates From Other Coordinates

Many commands allow you to construct a coordinate in terms of other coordinates.

### 70.5.1 Basic Manipulations of Coordinates

`\pgfpointadd{<v1>}{<v2>}`

Returns the sum vector  $\langle v_1 \rangle + \langle v_2 \rangle$ .

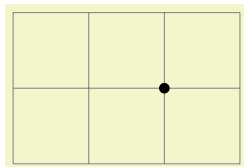

```
\begin{tikzpicture}
\draw[help lines] (0,0) grid (3,2);
\pgfpathcircle{\pgfpointadd{\pgfpoint{1cm}{0cm}}{\pgfpoint{1cm}{1cm}}}{2pt}
\pgfusepath{fill}
\end{tikzpicture}
```

`\pgfpointscale{<factor>}{<coordinate>}`

Returns the vector  $\langle factor \rangle \langle coordinate \rangle$ .

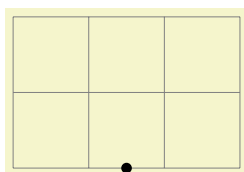

```
\begin{tikzpicture}
\draw[help lines] (0,0) grid (3,2);
\pgfpathcircle{\pgfpointscale{1.5}{\pgfpoint{1cm}{0cm}}}{2pt}
\pgfusepath{fill}
\end{tikzpicture}
```

`\pgfpointdiff`{ $\langle start \rangle$ }{ $\langle end \rangle$ }

Returns the difference vector  $\langle end \rangle - \langle start \rangle$ .

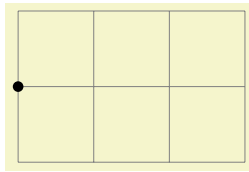

```
\begin{tikzpicture}
\draw[help lines] (0,0) grid (3,2);
\pgfpathcircle{\pgfpointdiff{\pgfpoint{1cm}{0cm}}{\pgfpoint{1cm}{1cm}}}{2pt}
\pgfusepath{fill}
\end{tikzpicture}
```

`\pgfpointnormalised`{ $\langle point \rangle$ }

This command returns a normalized version of  $\langle point \rangle$ , that is, a vector of length 1pt pointing in the direction of  $\langle point \rangle$ . If  $\langle point \rangle$  is the 0-vector or extremely short, a vector of length 1pt pointing upwards is returned.

This command is *not* implemented by calculating the length of the vector, but rather by calculating the angle of the vector and then using (something equivalent to) the `\pgfpointpolar` command. This ensures that the point will really have length 1pt, but it is not guaranteed that the vector will *precisely* point in the direction of  $\langle point \rangle$  due to the fact that the polar tables are accurate only up to one degree. Normally, this is not a problem.

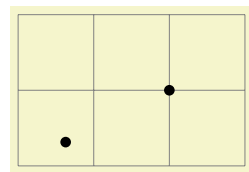

```
\begin{tikzpicture}
\draw[help lines] (0,0) grid (3,2);
\pgfpathcircle{\pgfpoint{2cm}{1cm}}{2pt}
\pgfpathcircle{\pgfpoint{scale{20}}
{\pgfpointnormalised{\pgfpoint{2cm}{1cm}}}}{2pt}
\pgfusepath{fill}
\end{tikzpicture}
```

## 70.5.2 Points Traveling along Lines and Curves

The commands in this section allow you to specify points on a line or a curve. Imagining a point “traveling” along a curve from some point  $p$  to another point  $q$ . At time  $t = 0$  the point is at  $p$  and at time  $t = 1$  it is at  $q$  and at time, say,  $t = 1/2$  it is “somewhere in the middle.” The exact location at time  $t = 1/2$  will not necessarily be the “halfway point,” that is, the point whose distance on the curve from  $p$  and  $q$  is equal. Rather, the exact location will depend on the “speed” at which the point is traveling, which in turn depends on the lengths of the support vectors in a complicated manner. If you are interested in the details, please see a good book on Bézier curves.

`\pgfpointlineatime`{ $\langle time t \rangle$ }{ $\langle point p \rangle$ }{ $\langle point q \rangle$ }

Yields a point that is the  $t$ th fraction between  $p$  and  $q$ , that is,  $p + t(q - p)$ . For  $t = 1/2$  this is the middle of  $p$  and  $q$ .

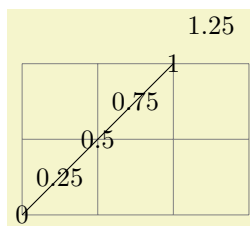

```
\begin{tikzpicture}
\draw[help lines] (0,0) grid (3,2);
\pgfpathmoveto{\pgfpointorigin}
\pgfpathlineto{\pgfpoint{2cm}{2cm}}
\pgfusepath{stroke}
\foreach \t in {0,0.25,...,1.25}
{\pgftext[at=
\pgfpointlineatime{\t}{\pgfpointorigin}{\pgfpoint{2cm}{2cm}}]{\t}}
\end{tikzpicture}
```

`\pgfpointlineatdistance`{ $\langle distance \rangle$ }{ $\langle start point \rangle$ }{ $\langle end point \rangle$ }

Yields a point that is located  $\langle distance \rangle$  many units removed from the start point in the direction of the end point. In other words, this is the point that results if we travel  $\langle distance \rangle$  steps from  $\langle start point \rangle$  towards  $\langle end point \rangle$ .

*Example:*



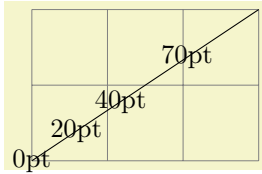

```
\begin{tikzpicture}
\draw[help lines] (0,0) grid (3,2);
\pgfpathmoveto{\pgfpointorigin}
\pgfpathlineto{\pgfpoint{3cm}{2cm}}
\pgfusepath{stroke}
\foreach \d in {0pt,20pt,40pt,70pt}
{\pgftext[at=
\pgfpointlineatdistance{\d}{\pgfpointorigin}{\pgfpoint{3cm}{2cm}}]{\d}}
\end{tikzpicture}
```

**`\pgfpointcurveatime`** $\langle\textit{time } t\rangle\langle\textit{point } p\rangle\langle\textit{point } s_1\rangle\langle\textit{point } s_2\rangle\langle\textit{point } q\rangle$

Yields a point that is on the Bézier curve from  $p$  to  $q$  with the support points  $s_1$  and  $s_2$ . The time  $t$  is used to determine the location, where  $t = 0$  yields  $p$  and  $t = 1$  yields  $q$ .

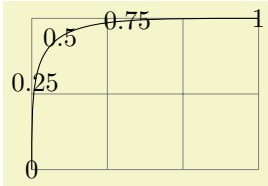

```
\begin{tikzpicture}
\draw[help lines] (0,0) grid (3,2);
\pgfpathmoveto{\pgfpointorigin}
\pgfpathcurveto
{\pgfpoint{0cm}{2cm}}{\pgfpoint{0cm}{2cm}}{\pgfpoint{3cm}{2cm}}
\pgfusepath{stroke}
\foreach \t in {0,0.25,0.5,0.75,1}
{\pgftext[at=\pgfpointcurveatime{\t}{\pgfpointorigin}
{\pgfpoint{0cm}{2cm}}
{\pgfpoint{0cm}{2cm}}
{\pgfpoint{3cm}{2cm}}]{\t}}
\end{tikzpicture}
```

### 70.5.3 Points on Borders of Objects

The following commands are useful for specifying a point that lies on the border of special shapes. They are used, for example, by the shape mechanism to determine border points of shapes.

**`\pgfpointborderrectangle`** $\langle\textit{direction point}\rangle\langle\textit{corner}\rangle$

This command returns a point that lies on the intersection of a line starting at the origin and going towards the point  $\langle\textit{direction point}\rangle$  and a rectangle whose center is in the origin and whose upper right corner is at  $\langle\textit{corner}\rangle$ .

The  $\langle\textit{direction point}\rangle$  should have length “about 1pt,” but it will be normalized automatically. Nevertheless, the “nearer” the length is to 1pt, the less rounding errors.

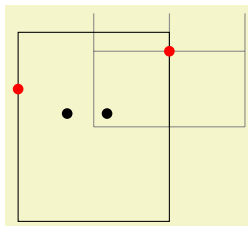

```
\begin{tikzpicture}
\draw[help lines] (0,0) grid (2,1.5);
\pgfpathrectanglecorners{\pgfpoint{-1cm}{-1.25cm}}{\pgfpoint{1cm}{1.25cm}}
\pgfusepath{stroke}

\pgfpathcircle{\pgfpoint{5pt}{5pt}}{2pt}
\pgfpathcircle{\pgfpoint{-10pt}{5pt}}{2pt}
\pgfusepath{fill}
\color{red}
\pgfpathcircle{\pgfpointborderrectangle
{\pgfpoint{5pt}{5pt}}{\pgfpoint{1cm}{1.25cm}}}{2pt}
\pgfpathcircle{\pgfpointborderrectangle
{\pgfpoint{-10pt}{5pt}}{\pgfpoint{1cm}{1.25cm}}}{2pt}
\pgfusepath{fill}
\end{tikzpicture}
```

**`\pgfpointborderellipse`** $\langle\textit{direction point}\rangle\langle\textit{corner}\rangle$

This command works like the corresponding command for rectangles, only this time the  $\langle\textit{corner}\rangle$  is the corner of the bounding rectangle of an ellipse.

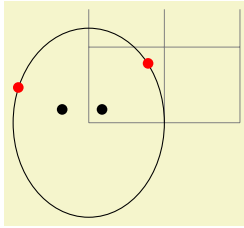

```

\begin{tikzpicture}
  \draw[help lines] (0,0) grid (2,1.5);
  \pgfpathellipse{\pgfpointorigin}{\pgfpoint{1cm}{0cm}}{\pgfpoint{0cm}{1.25cm}}
  \pgfusepath{stroke}

  \pgfpathcircle{\pgfpoint{5pt}{5pt}}{2pt}
  \pgfpathcircle{\pgfpoint{-10pt}{5pt}}{2pt}
  \pgfusepath{fill}
  \color{red}
  \pgfpathcircle{\pgfpointborderellipse
    {\pgfpoint{5pt}{5pt}}{\pgfpoint{1cm}{1.25cm}}}{2pt}
  \pgfpathcircle{\pgfpointborderellipse
    {\pgfpoint{-10pt}{5pt}}{\pgfpoint{1cm}{1.25cm}}}{2pt}
  \pgfusepath{fill}
\end{tikzpicture}

```

#### 70.5.4 Points on the Intersection of Lines

`\pgfpointintersectionoflines`{ $\langle p \rangle$ }{ $\langle q \rangle$ }{ $\langle s \rangle$ }{ $\langle t \rangle$ }

This command returns the intersection of a line going through  $p$  and  $q$  and a line going through  $s$  and  $t$ . If the lines do not intersect, an arithmetic overflow will occur.

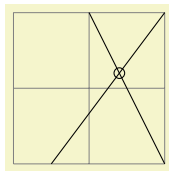

```

\begin{tikzpicture}
  \draw[help lines] (0,0) grid (2,2);
  \draw (.5,0) -- (2,2);
  \draw (1,2) -- (2,0);
  \pgfpathcircle{%
    \pgfpointintersectionoflines
      {\pgfpointxy{.5}{0}}{\pgfpointxy{2}{2}}
      {\pgfpointxy{1}{2}}{\pgfpointxy{2}{0}}
    }{2pt}
  \pgfusepath{stroke}
\end{tikzpicture}

```

#### 70.5.5 Points on the Intersection of Two Circles

`\pgfpointintersectionofcircles`{ $\langle p_1 \rangle$ }{ $\langle p_2 \rangle$ }{ $\langle r_1 \rangle$ }{ $\langle r_2 \rangle$ }{ $\langle solution \rangle$ }

This command returns the intersection of the two circles centered at  $p_1$  and  $p_2$  with radii  $r_1$  and  $r_2$ . If  $\langle solution \rangle$  is 1, the first intersection is returned, otherwise the second one is returned.

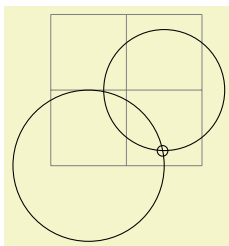

```

\begin{tikzpicture}
  \draw[help lines] (0,0) grid (2,2);
  \draw (0.5,0) circle (1);
  \draw (1.5,1) circle (.8);
  \pgfpathcircle{%
    \pgfpointintersectionofcircles
      {\pgfpointxy{.5}{0}}{\pgfpointxy{1.5}{1}}
      {1cm}{0.8cm}{1}
    }{2pt}
  \pgfusepath{stroke}
\end{tikzpicture}

```

#### 70.5.6 Points on the Intersection of Two Paths

```

\usepgflibrary{intersections} %  $\mathbb{E}\mathbb{T}\mathbb{X}$  and plain  $\mathbb{T}\mathbb{E}\mathbb{X}$  and pure pgf
\usepgflibrary[intersections] %  $\text{Con}\mathbb{T}\mathbb{E}\mathbb{X}$ t and pure pgf
\usetikzlibrary{intersections} %  $\mathbb{E}\mathbb{T}\mathbb{X}$  and plain  $\mathbb{T}\mathbb{E}\mathbb{X}$  when using TikZ
\usetikzlibrary[intersections] %  $\text{Con}\mathbb{T}\mathbb{E}\mathbb{X}$ t when using TikZ

```

This library defines the below command and allows you to calculate the intersections of two arbitrary paths. However, due to the low accuracy of  $\mathbb{T}\mathbb{E}\mathbb{X}$ , the paths should not be “too complicated”. In particular, you should not try to intersect paths consisting lots of very small segments such as plots or decorated paths.

`\pgfintersectionofpaths`{ $\langle path 1 \rangle$ }{ $\langle path 2 \rangle$ }

This command finds the intersection points on the paths  $\langle path 1 \rangle$  and  $\langle path 2 \rangle$ . The number of intersection points (“solutions”) that are found will be stored, and each point can be accessed afterward. The code for  $\langle path 1 \rangle$  and  $\langle path 2 \rangle$  is executed within a T<sub>E</sub>X group and so can contain transformations (which will be in addition to any existing transformations). The code should not use the path in any way, unless the path is saved first and restored afterward. PGF will regard solutions as “a bit special”, in that the points returned will be “absolute” and unaffected by any further transformations.

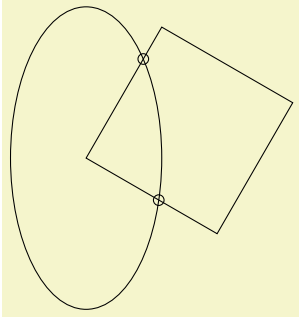

```
\begin{pgfpicture}
\pgfintersectionofpaths
{
\pgfpathellipse{\pgfpointxy{0}{0}}{\pgfpointxy{1}{0}}{\pgfpointxy{0}{2}}
\pgfgetpath\temppath
\pgfusepath{stroke}
\pgfsetpath\temppath
}
{
\pgftransformrotate{-30}
\pgfpathrectangle{\pgfpointorigin}{\pgfpointxy{2}{2}}
\pgfgetpath\temppath
\pgfusepath{stroke}
\pgfsetpath\temppath
}
}
\foreach \s in {1,...,\pgfintersectionsolutions}
{\pgfpathcircle{\pgfpointintersectionsolution{\s}}{2pt}}
\pgfusepath{stroke}
\end{pgfpicture}
```

### **\pgfintersectionsolutions**

After using the `\pgfintersectionofpaths` command, this T<sub>E</sub>X-macro will indicate the number of solutions found.

### **\pgfpointintersectionsolution{<number>}**

After using the `\pgfintersectionofpaths` command, this command will return the point for solution  $\langle number \rangle$  or the origin if this solution was not found. By default, the intersections are simply returned in the order that the intersection algorithm finds them. Unfortunately, this is not necessarily a “helpful” ordering. However the following two commands can be used to order the solutions more helpfully.

### **\pgfintersectionsorthbyfirstpath**

Using this command will mean the solutions will be sorted along  $\langle path 1 \rangle$ .

### **\pgfintersectionsorthbysecondpath**

Using this command will mean the solutions will be sorted along  $\langle path 2 \rangle$ .

## 70.6 Extracting Coordinates

There are two commands that can be used to “extract” the  $x$ - or  $y$ -coordinate of a coordinate.

### **\pgfextractx{<dimension>}{<point>}**

Sets the T<sub>E</sub>X- $\langle dimension \rangle$  to the  $x$ -coordinate of the point.

```
\newdimen\mydim
\pgfextractx{\mydim}{\pgfpoint{2cm}{4pt}}
%% \mydim is now 2cm
```

### **\pgfextracty{<dimension>}{<point>}**

Like `\pgfextractx`, except for the  $y$ -coordinate.

## 70.7 Internals of How Point Commands Work

As a normal user of PGF you do not need to read this section. It is relevant only if you need to understand how the point commands work internally.

When a command like `\pgfpoint{1cm}{2pt}` is called, all that happens is that the two TeX-dimension variables `\pgf@x` and `\pgf@y` are set to `1cm` and `2pt`, respectively. These variables belong to the set of internal PGF registers, see section 85 for details. A command like `\pgfpathmoveto` that takes a coordinate as parameter will just execute this parameter and then use the values of `\pgf@x` and `\pgf@y` as the coordinates to which it will move the pen on the current path.

since commands like `\pgfpointnormalised` modify other variables besides `\pgf@x` and `\pgf@y` during the computation of the final values of `\pgf@x` and `\pgf@y`, it is a good idea to enclose a call of a command like `\pgfpoint` in a TeX-scope and then make the changes of `\pgf@x` and `\pgf@y` global as in the following example:

```
...
{ % open scope
  \pgfpointnormalised{\pgfpoint{1cm}{1cm}}
  \global\pgf@x=\pgf@x % make the change of \pgf@x persist past the scope
  \global\pgf@y=\pgf@y % make the change of \pgf@y persist past the scope
}
% \pgf@x and \pgf@y are now set correctly, all other variables are
% unchanged
```

Since this situation arises very often, the macro `\pgf@process` can be used to perform the above code:

`\pgf@process{<code>}`

Executes the `<code>` in a scope and then makes `\pgf@x` and `\pgf@y` global.

Note that this macro is used often internally. For this reason, it is not a good idea to keep anything important in the variables `\pgf@x` and `\pgf@y` since they will be overwritten and changed frequently. Instead, intermediate values can be stored in the TeX-dimensions `\pgf@xa`, `\pgf@xb`, `\pgf@xc` and their y-counterparts `\pgf@ya`, `\pgf@yb`, `\pgf@yc`. For example, here is the code of the command `\pgfpointadd`:

```
\def\pgfpointadd#1#2{%
  \pgf@process{#1}%
  \pgf@xa=\pgf@x%
  \pgf@ya=\pgf@y%
  \pgf@process{#2}%
  \advance\pgf@x by\pgf@xa%
  \advance\pgf@y by\pgf@ya}
```

## 71 Constructing Paths

### 71.1 Overview

The “basic entity of drawing” in PGF is the *path*. A path consists of several parts, each of which is either a closed or open curve. An open curve has a starting point and an end point and, in between, consists of several *segments*, each of which is either a straight line or a Bézier curve. Here is an example of a path (in red) consisting of two parts, one open, one closed:

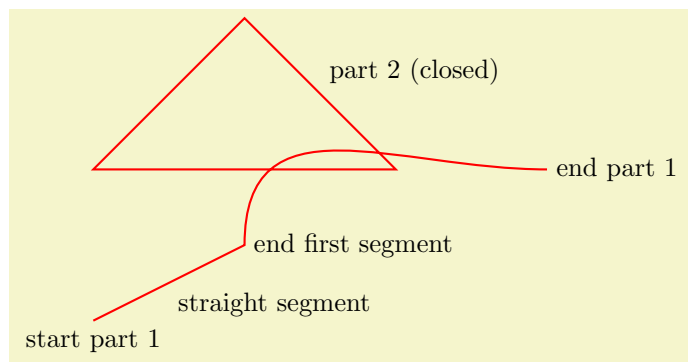

```
\begin{tikzpicture}[scale=2]
  \draw[thick,red]
    (0,0) coordinate (a)
    -- coordinate (ab) (1,.5) coordinate (b)
    .. coordinate (bc) controls +(up:1cm) and +(left:1cm) .. (3,1) coordinate (c)
    (0,1) -- (2,1) -- coordinate (x) (1,2) -- cycle;

  \draw (a) node[below] {start part 1}
        (ab) node[below right] {straight segment}
        (b) node[right] {end first segment}
        (c) node[right] {end part 1}
        (x) node[above right] {part 2 (closed)};
\end{tikzpicture}
```

A path, by itself, has no “effect,” that is, it does not leave any marks on the page. It is just a set of points on the plane. However, you can *use* a path in different ways. The most natural actions are *stroking* (also known as *drawing*) and *filling*. Stroking can be imagined as picking up a pen of a certain diameter and “moving it along the path.” Filling means that everything “inside” the path is filled with a uniform color. Naturally, the open parts of a path must first be closed before a path can be filled.

In PGF, there are numerous commands for constructing paths, all of which start with `\pgfpath`. There are also commands for *using* paths, though most operations can be performed by calling `\pgfusepath` with an appropriate parameter.

As a side-effect, the path construction commands keep track of two bounding boxes. One is the bounding box for the current path, the other is a bounding box for all paths in the current picture. See Section 71.13 for more details.

Each path construction command extends the current path in some way. The “current path” is a global entity that persists across  $\text{T}_{\text{E}}\text{X}$  groups. Thus, between calls to the path construction commands you can perform arbitrary computations and even open and closed  $\text{T}_{\text{E}}\text{X}$  groups. The current path only gets “flushed” when the `\pgfusepath` command is called (or when the soft-path subsystem is used directly, see Section 89).

### 71.2 The Move-To Path Operation

The most basic operation is the move-to operation. It must be given at the beginning of paths, though some path construction command (like `\pgfpathrectangle`) generate move-tos implicitly. A move-to operation can also be used to start a new part of a path.

`\pgfpathmoveto{<coordinate>}`

This command expects a PGF-coordinate like `\pgfpointorigin` as its parameter. When the current path is empty, this operation will start the path at the given *<coordinate>*. If a path has already been partially constructed, this command will end the current part of the path and start a new one.



```
\begin{pgfpicture}
  \pgfpathmoveto{\pgfpointorigin}
  \pgfpathlineto{\pgfpoint{1cm}{1cm}}
  \pgfpathlineto{\pgfpoint{2cm}{1cm}}
  \pgfpathlineto{\pgfpoint{3cm}{0.5cm}}
  \pgfpathlineto{\pgfpoint{3cm}{0cm}}
  \pgfsetfillcolor{examplefill}
  \pgfusepath{fill,stroke}
\end{pgfpicture}
```



```
\begin{pgfpicture}
  \pgfpathmoveto{\pgfpointorigin}
  \pgfpathlineto{\pgfpoint{1cm}{1cm}}
  \pgfpathlineto{\pgfpoint{2cm}{1cm}}
  \pgfpathmoveto{\pgfpoint{2cm}{1cm}} % New part
  \pgfpathlineto{\pgfpoint{3cm}{0.5cm}}
  \pgfpathlineto{\pgfpoint{3cm}{0cm}}
  \pgfsetfillcolor{examplefill}
  \pgfusepath{fill,stroke}
\end{pgfpicture}
```

The command will apply the current coordinate transformation matrix to  $\langle coordinate \rangle$  before using it. The command will update the bounding box of the current path and picture, if necessary.

### 71.3 The Line-To Path Operation

`\pgfpathlineto` $\langle coordinate \rangle$

This command extends the current path in a straight line to the given  $\langle coordinate \rangle$ . If this command is given at the beginning of path without any other path construction command given before (in particular without a move-to operation), the  $\TeX$  file may compile without an error message, but a viewer application may display an error message when trying to render the picture.

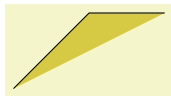

```
\begin{pgfpicture}
  \pgfpathmoveto{\pgfpointorigin}
  \pgfpathlineto{\pgfpoint{1cm}{1cm}}
  \pgfpathlineto{\pgfpoint{2cm}{1cm}}
  \pgfsetfillcolor{examplefill}
  \pgfusepath{fill,stroke}
\end{pgfpicture}
```

The command will apply the current coordinate transformation matrix to  $\langle coordinate \rangle$  before using it. The command will update the bounding box of the current path and picture, if necessary.

### 71.4 The Curve-To Path Operations

`\pgfpathcurveto` $\langle support 1 \rangle \langle support 2 \rangle \langle coordinate \rangle$

This command extends the current path with a Bézier curve from the last point of the path to  $\langle coordinate \rangle$ . The  $\langle support 1 \rangle$  and  $\langle support 2 \rangle$  are the first and second support point of the Bézier curve. For more information on Bézier curve, please consult a standard textbook on computer graphics. Like the line-to command, this command may not be the first path construction command in a path.



```
\begin{pgfpicture}
  \pgfpathmoveto{\pgfpointorigin}
  \pgfpathcurveto
    {\pgfpoint{1cm}{1cm}}{\pgfpoint{2cm}{1cm}}{\pgfpoint{3cm}{0cm}}
  \pgfsetfillcolor{examplefill}
  \pgfusepath{fill,stroke}
\end{pgfpicture}
```

The command will apply the current coordinate transformation matrix to  $\langle coordinate \rangle$  before using it. The command will update the bounding box of the current path and picture, if necessary. However, the bounding box is simply made large enough such that it encompasses all of the support points and the  $\langle coordinate \rangle$ . This will guarantee that the curve is completely inside the bounding box, but the bounding box will typically be quite a bit too large. It is not clear (to me) how this can be avoided without resorting to “some serious math” in order to calculate a precise bounding box.

### `\pgfpathquadraticcurveto`{*support*}{*coordinate*}

This command works like `\pgfpathcurveto`, only it uses a quadratic Bézier curve rather than a cubic one. This means that only one support point is needed.



```
\begin{pgfpicture}
  \pgfpathmoveto{\pgfpointorigin}
  \pgfpathquadraticcurveto
    {\pgfpoint{1cm}{1cm}}{\pgfpoint{2cm}{0cm}}
  \pgfsetfillcolor{examplefill}
  \pgfusepath{fill,stroke}
\end{pgfpicture}
```

Internally, the quadratic curve is converted into a cubic curve. The only noticeable effect of this is that the points used for computing the bounding box are the control points of the converted curve rather than *support*. The main effect of this is that the bounding box will be a bit tighter than might be expected. In particular, *support* will not always be part of the bounding box.

There exist two commands to draw only part of a cubic Bézier curve:

### `\pgfpathcurvebetweentime`{*time t<sub>1</sub>*}{*time t<sub>2</sub>*}{*point p*}{*point s<sub>1</sub>*}{*point s<sub>2</sub>*}{*point q*}

This command draws the part of the curve described by *p*, *s<sub>1</sub>*, *s<sub>2</sub>* and *q* between the times *t<sub>1</sub>* and *t<sub>2</sub>*. A time value of 0 indicates the point *p* and a time value of 1 indicates point *q*. This command includes a `moveto` operation to the first point.



```
\begin{tikzpicture}
  \draw [thin] (0,0) .. controls (0,2) and (3,0) .. (3,2);
  \pgfpathcurvebetweentime{0.25}{0.9}{\pgfpointxy{0}{0}}{\pgfpointxy{0}{2}}
    {\pgfpointxy{3}{0}}{\pgfpointxy{3}{2}}
  \pgfsetstrokecolor{red}
  \pgfsetstrokeopacity{0.5}
  \pgfsetlinewidth{2pt}
  \pgfusepath{stroke}
\end{tikzpicture}
```

### `\pgfpathcurvebetweentimecontinue`{*time t<sub>1</sub>*}{*time t<sub>2</sub>*}{*point p*}{*point s<sub>1</sub>*}{*point s<sub>2</sub>*}{*point q*}

This command works like `\pgfpathcurvebetweentime`, except that a `moveto` operation is *not* made to the first point.

## 71.5 The Close Path Operation

### `\pgfpathclose`

This command closes the current part of the path by appending a straight line to the start point of the current part. Note that there *is* a difference between closing a path and using the `line-to` operation to add a straight line to the start of the current path. The difference is demonstrated by the upper corners of the triangles in the following example:

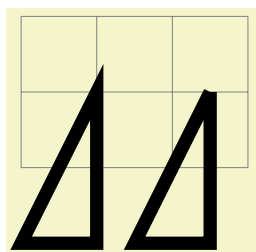

```
\begin{tikzpicture}
  \draw[help lines] (0,0) grid (3,2);
  \pgfsetlinewidth{5pt}
  \pgfpathmoveto{\pgfpoint{1cm}{1cm}}
  \pgfpathlineto{\pgfpoint{0cm}{-1cm}}
  \pgfpathlineto{\pgfpoint{1cm}{-1cm}}
  \pgfpathclose
  \pgfpathmoveto{\pgfpoint{2.5cm}{1cm}}
  \pgfpathlineto{\pgfpoint{1.5cm}{-1cm}}
  \pgfpathlineto{\pgfpoint{2.5cm}{-1cm}}
  \pgfpathlineto{\pgfpoint{2.5cm}{1cm}}
  \pgfusepath{stroke}
\end{tikzpicture}
```

## 71.6 Arc, Ellipse and Circle Path Operations

The path construction commands that we have discussed up to now are sufficient to create all paths that can be created “at all.” However, it is useful to have special commands to create certain shapes, like circles, that arise often in practice.

In the following, the commands for adding (parts of) (transformed) circles to a path are described.

**`\pgfpatharc`** $\langle start\ angle\rangle\langle end\ angle\rangle\langle radius\rangle$  and  $\langle y\text{-}radius\rangle$

This command appends a part of a circle (or an ellipse) to the current path. Imaging the curve between  $\langle start\ angle\rangle$  and  $\langle end\ angle\rangle$  on a circle of radius  $\langle radius\rangle$  (if  $\langle start\ angle\rangle < \langle end\ angle\rangle$ , the curve goes around the circle counterclockwise, otherwise clockwise). This curve is now moved such that the point where the curve starts is the previous last point of the path. Note that this command will *not* start a new part of the path, which is important for example for filling purposes.

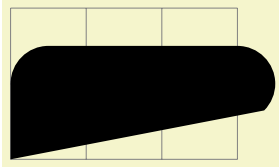

```
\begin{tikzpicture}
\draw[help lines] (0,0) grid (3,2);
\pgfpathmoveto{\pgfpointorigin}
\pgfpathlineto{\pgfpoint{0cm}{1cm}}
\pgfpatharc{180}{90}{.5cm}
\pgfpathlineto{\pgfpoint{3cm}{1.5cm}}
\pgfpatharc{90}{-45}{.5cm}
\pgfusepath{fill}
\end{tikzpicture}
```

Saying `\pgfpatharc{0}{360}{1cm}` “nearly” gives you a full circle. The “nearly” refers to the fact that the circle will not be closed. You can close it using `\pgfpathclose`.

If the optional  $\langle y\text{-}radius\rangle$  is given, the  $\langle radius\rangle$  is the  $x$ -radius and the  $\langle y\text{-}radius\rangle$  the  $y$ -radius of the ellipse from which the curve is taken:

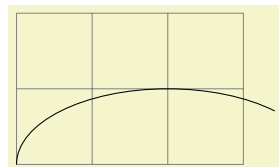

```
\begin{tikzpicture}
\draw[help lines] (0,0) grid (3,2);
\pgfpathmoveto{\pgfpointorigin}
\pgfpatharc{180}{45}{2cm and 1cm}
\pgfusepath{draw}
\end{tikzpicture}
```

The axes of the circle or ellipse from which the arc is “taken” always point up and right. However, the current coordinate transformation matrix will have an effect on the arc. This can be used to, say, rotate an arc:

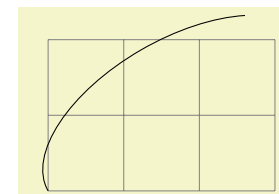

```
\begin{tikzpicture}
\draw[help lines] (0,0) grid (3,2);
\pgftransformrotate{30}
\pgfpathmoveto{\pgfpointorigin}
\pgfpatharc{180}{45}{2cm and 1cm}
\pgfusepath{draw}
\end{tikzpicture}
```

The command will update the bounding box of the current path and picture, if necessary. Unless rotation or shearing transformations are applied, the bounding box will be tight.

**`\pgfpatharcaxes`** $\langle start\ angle\rangle\langle end\ angle\rangle\langle first\ axis\rangle\langle second\ axis\rangle$

This command is similar to `\pgfpatharc`. The main difference is how the ellipse or circle is specified from which the arc is taken. The two parameters  $\langle first\ axis\rangle$  and  $\langle second\ axis\rangle$  are the  $0^\circ$ -axis and the  $90^\circ$ -axis of the ellipse from which the path is taken. Thus, `\pgfpatharc{0}{90}{1cm and 2cm}` has the same effect as

`\pgfpatharcaxes{0}{90}{\pgfpoint{1cm}{0cm}}{\pgfpoint{0cm}{2cm}}`

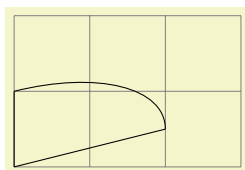

```
\begin{tikzpicture}
\draw[help lines] (0,0) grid (3,2);
\draw (0,0) -- (2cm,5mm) (0,0) -- (0cm,1cm);

\pgfpathmoveto{\pgfpoint{2cm}{5mm}}
\pgfpatharcaxes{0}{90}{\pgfpoint{2cm}{5mm}}{\pgfpoint{0cm}{1cm}}
\pgfusepath{draw}
\end{tikzpicture}
```

**`\pgfpatharcto`** $\langle x\text{-}radius\rangle\langle y\text{-}radius\rangle\langle rotation\rangle$   $\langle large\ arc\ flag\rangle\langle counterclockwise\ flag\rangle$   
 $\langle target\ point\rangle$



This command (which directly corresponds to the arc-path command of SVG) is used to add an arc to the path that starts at the current point and ends at (*target point*). This arc is part of an ellipse that is determined in the following way: Imagine an ellipse with radii  $\langle x\text{-radius} \rangle$  and  $\langle y\text{-radius} \rangle$  that is rotated around its center by  $\langle rotation \rangle$  degrees. When you move this ellipse around in the plane, there will be exactly two positions such that the two current point and the target point lie on the border of the ellipse (excluding pathological cases). The flags  $\langle large\ arc\ flag \rangle$  and  $\langle clockwise\ flag \rangle$  are then used to decide which of these ellipses should be picked and which arc on the picked ellipsis should be used.

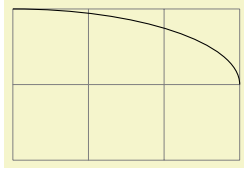

```
\begin{tikzpicture}
  \draw[help lines] (0,0) grid (3,2);

  \pgfpathmoveto{\pgfpoint{0mm}{20mm}}
  \pgfpatharcto{3cm}{1cm}{0}{0}{0}{\pgfpoint{3cm}{1cm}}
  \pgfusepath{draw}
\end{tikzpicture}
```

Both flags are considered to be false exactly if they evaluate to 0, otherwise they are true. If the  $\langle large\ arc\ flag \rangle$  is true, then the angle spanned by the arc will be greater than  $180^\circ$ , otherwise it will be less than  $180^\circ$ . The  $\langle clockwise\ flag \rangle$  is used to determine which of the two ellipses should be used: if the flag is true, then the arc goes from the current point to the target point in a counterclockwise direction, otherwise in a clockwise fashion.

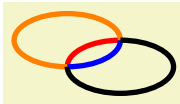

```
\begin{tikzpicture}
  \pgfsetlinewidth{2pt}
  % Flags 0 0: red
  \pgfsetstrokecolor{red}
  \pgfpathmoveto{\pgfpointorigin}
  \pgfpatharcto{20pt}{10pt}{0}{0}{0}{\pgfpoint{20pt}{10pt}}
  \pgfusepath{stroke}
  % Flags 0 1: blue
  \pgfsetstrokecolor{blue}
  \pgfpathmoveto{\pgfpointorigin}
  \pgfpatharcto{20pt}{10pt}{0}{0}{1}{\pgfpoint{20pt}{10pt}}
  \pgfusepath{stroke}
  % Flags 1 0: orange
  \pgfsetstrokecolor{orange}
  \pgfpathmoveto{\pgfpointorigin}
  \pgfpatharcto{20pt}{10pt}{0}{1}{0}{\pgfpoint{20pt}{10pt}}
  \pgfusepath{stroke}
  % Flags 1 1: black
  \pgfsetstrokecolor{black}
  \pgfpathmoveto{\pgfpointorigin}
  \pgfpatharcto{20pt}{10pt}{0}{1}{1}{\pgfpoint{20pt}{10pt}}
  \pgfusepath{stroke}
\end{tikzpicture}
```

*Warning:* The internal computations necessary for this command are numerically very unstable. In particular, the arc will not always really end at the (*target coordinate*), but may be off by up to several points. A more precise positioning is currently infeasible due to T<sub>E</sub>X's numerical weaknesses. The only case that works quite nicely is when the resulting angle is a multiple of  $90^\circ$ .

**`\pgfpathelllipse`** $\langle center \rangle$  $\langle first\ axis \rangle$  $\langle second\ axis \rangle$

The effect of this command is to append an ellipse to the current path (if the path is not empty, a new part is started). The ellipse's center will be  $\langle center \rangle$  and  $\langle first\ axis \rangle$  and  $\langle second\ axis \rangle$  are the axis *vectors*. The same effect as this command can also be achieved using an appropriate sequence of move-to, arc, and close operations, but this command is easier and faster.

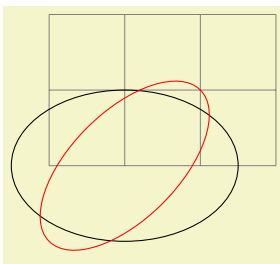

```
\begin{tikzpicture}
  \draw[help lines] (0,0) grid (3,2);
  \pgfpathelllipse{\pgfpoint{1cm}{0cm}}
    {\pgfpoint{1.5cm}{0cm}}
    {\pgfpoint{0cm}{1cm}}
  \pgfusepath{draw}
  \color{red}
  \pgfpathelllipse{\pgfpoint{1cm}{0cm}}
    {\pgfpoint{1cm}{1cm}}
    {\pgfpoint{-0.5cm}{0.5cm}}
  \pgfusepath{draw}
\end{tikzpicture}
```

The command will apply coordinate transformations to all coordinates of the ellipse. However, the coordinate transformations are applied only after the ellipse is “finished conceptually.” Thus, a transformation of 1cm to the right will simply shift the ellipse one centimeter to the right; it will not add 1cm to the  $x$ -coordinates of the two axis vectors.

The command will update the bounding box of the current path and picture, if necessary.

`\pgfpathcircle{⟨center⟩}{⟨radius⟩}`

A shorthand for `\pgfpathellipse` applied to `⟨center⟩` and the two axis vectors `(⟨radius⟩,0)` and `(0,⟨radius⟩)`.

## 71.7 Rectangle Path Operations

Another shape that arises frequently is the rectangle. Two commands can be used to add a rectangle to the current path. Both commands will start a new part of the path.

`\pgfpathrectangle{⟨corner⟩}{⟨diagonal vector⟩}`

Adds a rectangle to the path whose one corner is `⟨corner⟩` and whose opposite corner is given by `⟨corner⟩ + ⟨diagonal vector⟩`.

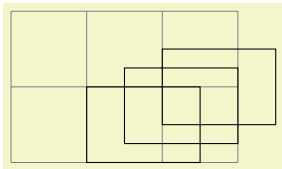

```
\begin{tikzpicture}
\draw[help lines] (0,0) grid (3,2);
\pgfpathrectangle{\pgfpoint{1cm}{0cm}}{\pgfpoint{1.5cm}{1cm}}
\pgfpathrectangle{\pgfpoint{1.5cm}{0.25cm}}{\pgfpoint{1.5cm}{1cm}}
\pgfpathrectangle{\pgfpoint{2cm}{0.5cm}}{\pgfpoint{1.5cm}{1cm}}
\pgfusepath{draw}
\end{tikzpicture}
```

The command will apply coordinate transformations and update the bounding boxes tightly.

`\pgfpathrectanglecorners{⟨corner⟩}{⟨opposite corner⟩}`

Adds a rectangle to the path whose two opposing corners are `⟨corner⟩` and `⟨opposite corner⟩`.

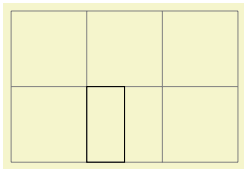

```
\begin{tikzpicture}
\draw[help lines] (0,0) grid (3,2);
\pgfpathrectanglecorners{\pgfpoint{1cm}{0cm}}{\pgfpoint{1.5cm}{1cm}}
\pgfusepath{draw}
\end{tikzpicture}
```

The command will apply coordinate transformations and update the bounding boxes tightly.

## 71.8 The Grid Path Operation

`\pgfpathgrid[⟨options⟩]{⟨lower left⟩}{⟨upper right⟩}`

Appends a grid to the current path. That is, a (possibly large) number of parts are added to the path, each part consisting of a single horizontal or vertical straight line segment.

Conceptually, the origin is part of the grid and the grid is clipped to the rectangle specified by the `⟨lower left⟩` and the `⟨upper right⟩` corner. However, no clipping occurs (this command just adds parts to the current path). Rather, the points where the lines enter and leave the “clipping area” are computed and used to add simple lines to the current path.

The following keys influence the grid:

`/pgf/stepx=⟨dimension⟩` (no default, initially 1cm)

The horizontal stepping.

`/pgf/stepy=⟨dimension⟩` (no default, initially 1cm)

The vertical stepping.

`/pgf/step=⟨vector⟩` (no default)

Sets the horizontal stepping to the  $x$ -coordinate of `⟨vector⟩` and the vertical stepping to its  $y$ -coordinate.

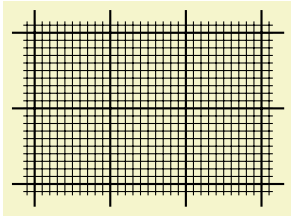

```
\begin{pgfpicture}
  \pgfsetlinewidth{0.8pt}
  \pgfpathgrid[step={\pgfpoint{1cm}{1cm}}]
    {\pgfpoint{-3mm}{-3mm}}{\pgfpoint{33mm}{23mm}}
  \pgfusepath{stroke}
  \pgfsetlinewidth{0.4pt}
  \pgfpathgrid[stepx=1mm,stepy=1mm]
    {\pgfpoint{-1.5mm}{-1.5mm}}{\pgfpoint{31.5mm}{21.5mm}}
  \pgfusepath{stroke}
\end{pgfpicture}
```

The command will apply coordinate transformations and update the bounding boxes tightly. As for ellipses, the transformations are applied to the “conceptually finished” grid.

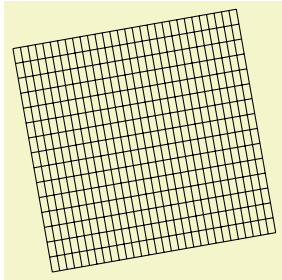

```
\begin{pgfpicture}
  \pgftransformrotate{10}
  \pgfpathgrid[stepx=1mm,stepy=2mm]{\pgfpoint{0mm}{0mm}}{\pgfpoint{30mm}{30mm}}
  \pgfusepath{stroke}
\end{pgfpicture}
```

## 71.9 The Parabola Path Operation

`\pgfpathparabola`{*⟨bend vector⟩*}{*⟨end vector⟩*}

This command appends two half-parabolas to the current path. The first starts at the current point and ends at the current point plus *⟨bend vector⟩*. At this point, it has its bend. The second half parabola starts at that bend point and ends at point that is given by the bend plus *⟨end vector⟩*.

If you set *⟨end vector⟩* to the null vector, you append only a half parabola that goes from the current point to the bend; by setting *⟨bend vector⟩* to the null vector, you append only a half parabola that goes to current point plus *⟨end vector⟩* and has its bend at the current point.

It is not possible to use this command to draw a part of a parabola that does not contain the bend.

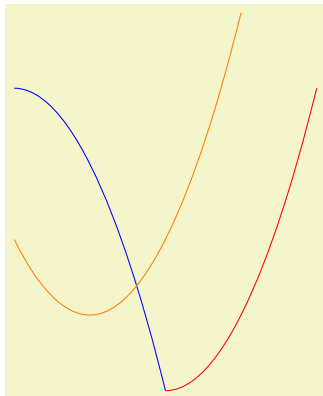

```
\begin{pgfpicture}
  % Half-parabola going “up and right”
  \pgfpathmoveto{\pgfpointorigin}
  \pgfpathparabola{\pgfpointorigin}{\pgfpoint{2cm}{4cm}}
  \color{red}
  \pgfusepath{stroke}

  % Half-parabola going “down and right”
  \pgfpathmoveto{\pgfpointorigin}
  \pgfpathparabola{\pgfpoint{-2cm}{4cm}}{\pgfpointorigin}
  \color{blue}
  \pgfusepath{stroke}

  % Full parabola
  \pgfpathmoveto{\pgfpoint{-2cm}{2cm}}
  \pgfpathparabola{\pgfpoint{1cm}{-1cm}}{\pgfpoint{2cm}{4cm}}
  \color{orange}
  \pgfusepath{stroke}
\end{pgfpicture}
```

The command will apply coordinate transformations and update the bounding boxes.

## 71.10 Sine and Cosine Path Operations

Sine and cosine curves often need to be drawn and the following commands may help with this. However, they only allow you to append sine and cosine curves in intervals that are multiples of  $\pi/2$ .

`\pgfpathsine`{*⟨vector⟩*}

This command appends a sine curve in the interval  $[0, \pi/2]$  to the current path. The sine curve is squeezed or stretched such that the curve starts at the current point and ends at the current point plus  $\langle vector \rangle$ .

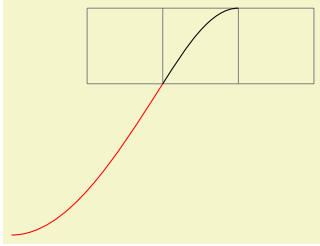

```
\begin{tikzpicture}
\draw[help lines] (0,0) grid (3,1);
\pgfpathmoveto{\pgfpoint{1cm}{0cm}}
\pgfpathsine{\pgfpoint{1cm}{1cm}}
\pgfusepath{stroke}

\color{red}
\pgfpathmoveto{\pgfpoint{1cm}{0cm}}
\pgfpathsine{\pgfpoint{-2cm}{-2cm}}
\pgfusepath{stroke}
\end{tikzpicture}
```

The command will apply coordinate transformations and update the bounding boxes.

`\pgfpathcosine` $\{\langle vector \rangle\}$

This command appends a cosine curve in the interval  $[0, \pi/2]$  to the current path. The curve is squeezed or stretched such that the curve starts at the current point and ends at the current point plus  $\langle vector \rangle$ . Using several sine and cosine operations in sequence allows you to produce a complete sine or cosine curve

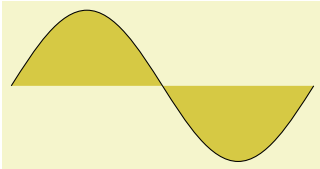

```
\begin{pgfpicture}
\pgfpathmoveto{\pgfpoint{0cm}{0cm}}
\pgfpathsine{\pgfpoint{1cm}{1cm}}
\pgfpathcosine{\pgfpoint{1cm}{-1cm}}
\pgfpathsine{\pgfpoint{1cm}{-1cm}}
\pgfpathcosine{\pgfpoint{1cm}{1cm}}
\pgfsetfillcolor{examplefill}
\pgfusepath{fill,stroke}
\end{pgfpicture}
```

The command will apply coordinate transformations and update the bounding boxes.

## 71.11 Plot Path Operations

There exist several commands for appending plots to a path. These commands are available through the module `plot`. They are documented in Section 81.

## 71.12 Rounded Corners

Normally, when you connect two straight line segments or when you connect two curves that end and start “at different angles” you get “sharp corners” between the lines or curves. In some cases it is desirable to produce “rounded corners” instead. Thus, the lines or curves should be shortened a bit and then connected by arcs.

PGF offers an easy way to achieve this effect, by calling the following two commands.

`\pgfsetcornersarced` $\{\langle point \rangle\}$

This command causes all subsequent corners to be replaced by little arcs. The effect of this command lasts till the end of the current  $\text{\TeX}$  scope.

The  $\langle point \rangle$  dictates how large the corner arc will be. Consider a corner made by two lines  $l$  and  $r$  and assume that the line  $l$  comes first on the path. The  $x$ -dimension of the  $\langle point \rangle$  decides by how much the line  $l$  will be shortened, the  $y$ -dimension of  $\langle point \rangle$  decides by how much the line  $r$  will be shortened. Then, the shortened lines are connected by an arc.

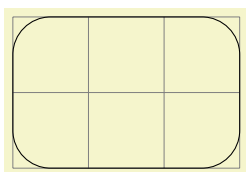

```
\begin{tikzpicture}
\draw[help lines] (0,0) grid (3,2);

\pgfsetcornersarced{\pgfpoint{5mm}{5mm}}
\pgfpathrectanglecorners{\pgfpointorigin}{\pgfpoint{3cm}{2cm}}
\pgfusepath{stroke}
\end{tikzpicture}
```

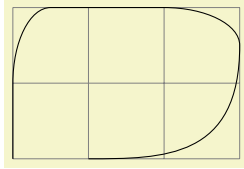

```

\begin{tikzpicture}
  \draw[help lines] (0,0) grid (3,2);

  \pgfsetcornersarced{\pgfpoint{10mm}{5mm}}
  % 10mm entering,
  % 5mm leaving.
  \pgfpathmoveto{\pgfpointorigin}
  \pgfpathlineto{\pgfpoint{0cm}{2cm}}
  \pgfpathlineto{\pgfpoint{3cm}{2cm}}
  \pgfpathcurveto
    {\pgfpoint{3cm}{0cm}}
    {\pgfpoint{2cm}{0cm}}
    {\pgfpoint{1cm}{0cm}}
  \pgfusepath{stroke}
\end{tikzpicture}

```

If the  $x$ - and  $y$ -coordinates of  $\langle point \rangle$  are the same and the corner is a right angle, you will get a perfect quarter circle (well, not quite perfect, but perfect up to six decimals). When the angle is not  $90^\circ$ , you only get a fair approximation.

More or less “all” corners will be rounded, even the corner generated by a `\pgfpathclose` command. (The author is a bit proud of this feature.)

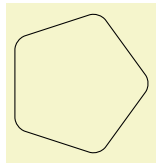

```

\begin{pgfpicture}
  \pgfsetcornersarced{\pgfpoint{4pt}{4pt}}
  \pgfpathmoveto{\pgfpointpolar{0}{1cm}}
  \pgfpathlineto{\pgfpointpolar{72}{1cm}}
  \pgfpathlineto{\pgfpointpolar{144}{1cm}}
  \pgfpathlineto{\pgfpointpolar{216}{1cm}}
  \pgfpathlineto{\pgfpointpolar{288}{1cm}}
  \pgfpathclose
  \pgfusepath{stroke}
\end{pgfpicture}

```

To return to normal (unrounded) corners, use `\pgfsetcornersarced{\pgfpointorigin}`.

Note that the rounding will produce strange and undesirable effects if the lines at the corners are too short. In this case the shortening may cause the lines to “suddenly extend over the other end” which is rarely desirable.

### 71.13 Internal Tracking of Bounding Boxes for Paths and Pictures

The path construction commands keep track of two bounding boxes: One for the current path, which is reset whenever the path is used and thereby flushed, and a bounding box for the current `{pgfpicture}`.

The bounding boxes are not accessible by “normal” macros. Rather, two sets of four dimension variables are used for this, all of which contain the letter `@`.

#### `\pgf@pathminx`

The minimum  $x$ -coordinate “mentioned” in the current path. Initially, this is set to 16000pt.

#### `\pgf@pathmaxx`

The maximum  $x$ -coordinate “mentioned” in the current path. Initially, this is set to  $-16000$ pt.

#### `\pgf@pathminy`

The minimum  $y$ -coordinate “mentioned” in the current path. Initially, this is set to 16000pt.

#### `\pgf@pathmaxy`

The maximum  $y$ -coordinate “mentioned” in the current path. Initially, this is set to  $-16000$ pt.

#### `\pgf@picminx`

The minimum  $x$ -coordinate “mentioned” in the current picture. Initially, this is set to 16000pt.

#### `\pgf@picmaxx`

The maximum  $x$ -coordinate “mentioned” in the current picture. Initially, this is set to  $-16000$ pt.

**`\pgf@picminy`**

The minimum  $y$ -coordinate “mentioned” in the current picture. Initially, this is set to 16000pt.

**`\pgf@picmaxy`**

The maximum  $y$ -coordinate “mentioned” in the current picture. Initially, this is set to  $-16000$ pt.

Each time a path construction command is called, the above variables are (globally) updated. To facilitate this, you can use the following command:

**`\pgf@protocolsizes`** $\langle x\text{-dimension} \rangle$  $\langle y\text{-dimension} \rangle$

Updates all of the above dimension in such a way that the point specified by the two arguments is inside both bounding boxes. For the picture’s bounding box this updating occurs only if `\ifpgf@relevantforpicturesize` is true, see below.

For the bounding box of the picture it is not always desirable that every path construction command affects this bounding box. For example, if you have just used a clip command, you do not want anything outside the clipping area to affect the bounding box. For this reason, there exists a special “ $\TeX$  if” that (locally) decides whether updating should be applied to the picture’s bounding box. Clipping will set this if to false, as will certain other commands.

**`\pgf@relevantforpicturesizefalse`**

Suppresses updating of the picture’s bounding box.

**`\pgf@relevantforpicturesizetrue`**

Causes updating of the picture’s bounding box.

## 72 Decorations

```
\usepgfmodule{decorations} %  $\TeX$  and plain  $\TeX$  and pure pgf
\usepgfmodule[decorations] % Con $\TeX$ t and pure pgf
```

The commands for creating decorations are defined in this module, so you need to load this module to use decorations. This module is automatically loaded by the different decoration libraries.

### 72.1 Overview

Decorations are a general way of creating graphics by “moving along” a path and, while doing so, either drawing something or constructing a new path. This could be as simple as extending a path with a “zigzagged” line...

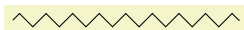

```
\tikz \draw decorate[decoration=zigzag] {(0,0) -- (3,0)};
```

... but could also be as complex as typesetting text along a path:

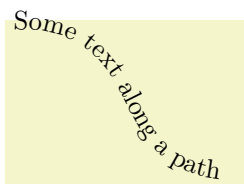

```
\tikz \path decorate [decoration={text along path,
text={Some text along a path}}]
{ (0,2) .. controls (2,2) and (1,0) .. (3,0) };
```

The workflow for using decorations is the following:

1. You define a decoration using the `\pgfdeclaredecoration` command. Different useful decorations are already declared in libraries like `decorations.shapes`.
2. You use normal path construction commands like `\pgfpathlineto` to construct a path. Let us call this path the *to-be-decorated* path.
3. You place the path construction commands inside the environment `{pgfdecoration}`. This environment takes the name of a previously declared decoration as a parameter. It will then starting “walking along” the to-be-decorated path. As it does this, a special finite automaton called a *decoration automaton* produces as its output new path construction commands (or even other outputs). These outputs replace the to-be-decorated path; indeed, after the to-be-decorated path has been fully walked along it is thrown away, only the output of the automaton persists.

In the present section the process of how decoration automata work is explained first. Then the command(s) for declaring decoration automata and for using them are covered.

### 72.2 Decoration Automata

Decoration automata (and the closely related meta-decoration automata) are a general concept for creating graphics “along paths.” For straight lines, this idea was first proposed by Till Tantau in an earlier version of PGF, the idea to extend this to arbitrary path was proposed and implemented by Mark Wibrow. Further versatility is provided by “meta-decorations”. These are automata that decorate a path with decorations.

In the present subsection the different ideas underlying decoration automata are presented.

#### 72.2.1 The Different Paths

In order to prevent confusion with different types of path, such as those that are extended, those that are decorated and those that are created, the following conventions will be used:

- The *preexisting* path refers to the current path in existence before a decoration environment. (Possibly this path has been created by another decoration used earlier, but we will still call this path the preexisting path also in this case.)
- The *input* path refers to the to-be-decorated path that the decoration automaton moves along. The input path may consist of many line and curve input segments (for example, a circle or an ellipse consists of four curves). It is specified inside the decoration environment.



- The *output* path refers to the path that the decoration creates. Depending on the decoration, this path may or may not be empty (a decoration can also choose to use side-effects instead of producing an output path). The input path is always consumed by the decoration automaton, that is, it is no longer available in any way after the decoration automaton has finished.

The effect of a decoration environment is the following: The input path, which is specified inside the environment, is constructed and stored. This process does not alter the preexisting path in any way. Then the decoration automaton is started (as described later) and it produces an output path (possibly empty). Whenever part of the output path is produced, it is concatenated with the preexisting path. After the environment, the current path will equal the original preexisting path followed by the output path.

It is permissible that a decoration issues a `\pgfusepath` command. As usual, this causes the current path to be filled or stroked or some other action to be taken and the current path is set to the empty path. As described above, when the decoration automaton starts the current path is the preexisting path and as the automaton progresses, the current path is constantly being extend by the output path. This means that first time e `\pgfusepath` command is used on a decoration, the preexisting path is part of the path this command operates on; in subsequent calls only the part of the output path constructed since the last `\pgfusepath` command will be used.

You can use this mechanism to stroke or fill different part of the output path in different colors, line widths, fills and shades; all within the same decoration. Alternatively, a decoration can choose to produce no output path at all: the `text` decoration simply typesets text along a path.

### 72.2.2 Segments and States

The most common use a decoration is to “repeat something along a path” (for example, the `zigzag` decoration repeats  $\sim$  along a path). However, it not necessarily the case that only one thing be repeated: a decoration can consist of different parts, or *segments*, repeated in a particular order.

When you declare a decoration, you provide a description of how their different segments will be rendered. The description of each segment should be given in a way as if the “x-axis” of the segment is the tangent to the path at a particular point, and that point is the origin of the segment. Thus, for example, the segment of the `zigzag` decoration might be defined using the following code:

```
\pgfpathlineto{\pgfpoint{5pt}{5pt}}
\pgfpathlineto{\pgfpoint{15pt}{-5pt}}
\pgfpathlineto{\pgfpoint{20pt}{0pt}}
```

PGF will ensure that an appropriate coordinate transformation is in place when the segment is rendered such that the segment actually points in the right direction. Also subsequent segments will be transformed such that they are “further along the path” toward the end of the path. All transformations are setup automatically.

Note that we did not use a `\pgfpathmoveto{\pgfpointorigin}` at the beginning of the segment code. Doing so would subdivide the path into numerous subpaths. Rather, we assume that the previous segment caused the current point to be at the origin.

The width of a segment can (and must) be specified explicitly. PGF will use this width to find out the start point of the next segment and the correct rotation. The width the you provide need not be the “real” width of the segment, which allows decoration segments to overlap or to be spaced far apart.

The `zigzag` decoration only has one segment that is repeated again and again. However, we might also like to have *different* segments and use rules to describe which segment should be used where. For example, we might have special segments at the start and at the end.

Decorations use a mechanism known in theoretical in computer science as *finite state automata* to describe which segment is used at a particular point. The idea is the following: For the first segment we start in a special *state* called the *initial state*. In this state, and also in all other state later, PGF first computes how much space is left on the input path. That is, PGF keeps track of the distance to the end of the input path. Attached to each state there is a set of rules of the following form: “If the remaining distance on the input path is less than  $x$ , switch to state  $q$ .” PGF checks for each of these rules whether it applies and, if so, immediately switches to state  $q$ .

Only if none of the rules tell us to switch to another state, PGF will execute the state’s code. This code will (typically) add a segment to the output path. In addition to the rules there is also width parameter attached to each state. PGF then translates the coordinate system by this width and reduces the remaining distance on the input path. Then, PGF either stays in the current state or switches to another state, depending on yet another property attached of the state.



The whole process stops when a special state called `final` is reached. The segment of this state is immediately added to the output path (it is often empty, though) and the process ends.

### 72.3 Declaring Decorations

The following command is used to declare a decoration. Essentially, this command describes the decoration automaton.

`\pgfdeclaredecoration`{*<name>*}{*<initial state>*}{*<states>*}

This command declares a new decoration called *<name>*. The *<states>* argument contains a description of the decoration automaton's states and the transitions between them. The *<initial state>* is the state in which the automaton starts.

When the automaton is later applied to an input path, it keeps track of a certain position on the input path. This current point will “travel along the path,” each time being moved along by a certain distance. This will also work if the path is not a straight line. That is, it is permissible that the path curves are veers at a sharp angle. It is also permissible that while travelling along the input path the current input segment ends and a new input segment starts. In this case, the remaining distance on the first input segment is subtracted from the *<dimension>* and then we travelled along the second input segment for the remaining distance. This input segment may also end early, in which case we travel along the next input segment, and so on. Note that it cannot happen that we travel past the end of the input path since this would have caused an immediate switch to the `final` state.

Note note that the computation of the path lengths has only a low accuracy because of  $\text{\TeX}$ 's small math capabilities. Do not expect high accuracy alignments when using decorations (unless the input path consists only of horizontal and vertical lines).

The *<states>* argument should consist of `\state` commands, one for each state of the decoration automaton. The `\state` command is defined only when the *<states>* argument is executed.

`\state`{*<name>*}[*<options>*]{*<code>*}

This command declares a new state inside the current decoration automaton. The state is named *<name>*.

When the decoration automaton is in state *<name>*, the following things happen:

1. The *<options>* are parsed. This may lead, see below, to a state switch. When this happens, the following steps are not executed. The *<options>* are executed one after the other in the given order. If an option causes a state switch, the switch is immediate, even if later options might cause a different state switch.
2. The *<code>* is executed in a  $\text{\TeX}$ -group with the current transformation matrix setup in such a way that the origin is on the input path at the current point (the point at the distance travelled up to now) and the coordinate system is rotated in such a way that the positive *x*-axis points in the direction of the tangent to the input path at the current point, while the positive *y*-axis points to the left of this tangent.

As described earlier, the *<code>* can have two different effects: If it just contains path construction commands, the decoration will produce an output path, which is extends the preexisting path. Here is an example:

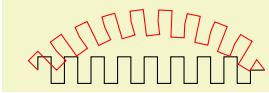

```

\pgfdeclaredecoration{example}{initial}
{
  \state{initial}[width=10pt]
  {
    \pgfpathlineto{\pgfpoint{0pt}{5pt}}
    \pgfpathlineto{\pgfpoint{5pt}{5pt}}
    \pgfpathlineto{\pgfpoint{5pt}{-5pt}}
    \pgfpathlineto{\pgfpoint{10pt}{-5pt}}
    \pgfpathlineto{\pgfpoint{10pt}{0pt}}
  }
  \state{final}
  {
    \pgfpathlineto{\pgfpointdecoratedpathlast}
  }
}
\tikz[decoration=example]
{
  \draw [decorate] (0,0) -- (3,0);
  \draw [red,decorate] (0,0) to [out=45,in=135] (3,0);
}

```

Alternatively, the `<code>` can also contain the `\pgfusepath` command. This will use the path in usual manner, where “the path” is the preexisting path plus a part of the output path for the first invocation and the different parts of the rest of the output path for the following invocation. Here is an example:

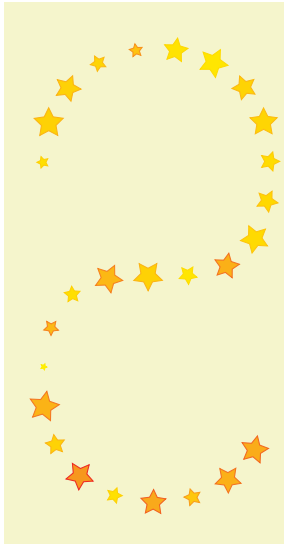

```

\pgfdeclaredecoration{stars}{initial}{
  \state{initial}[width=15pt]
  {
    \pgfmathparse{round(rnd*100)}
    \pgfsetfillcolor{yellow!\pgfmathresult!orange}
    \pgfsetstrokecolor{yellow!\pgfmathresult!red}
    \pgfnode{star}{center}{\pgfusepath{stroke,fill}}
  }
  \state{final}
  {
    \pgfpathmoveto{\pgfpointdecoratedpathlast}
  }
}
\tikz\path[decorate, decoration=stars, star point ratio=2, star points=5,
  inner sep=0, minimum size=rnd*10pt+2pt]
(0,0) .. controls (0,2) and (3,2) .. (3,0)
.. controls (3,-3) and (0,0) .. (0,-3)
.. controls (0,-5) and (3,-5) .. (3,-3);

```

3. After the `<code>` has been executed (possibly more than once, if the `repeat state` option is used), the state switches to whatever state has been specified inside the `<options>` using the `next state` option. If no `next state` has been specified, the state stays the same.

The `<options>` are executed with the key path set to `/pgf/decoration automaton`. The following keys are defined:

`/pgf/decoration automaton/switch if less than=<dimension> to <new state>` (no default)

When this key is encountered, PGF checks whether the remaining distance to the end of the input path is less than *<dimension>*. If so, an immediate state switch to *<new state>* occurs.

`/pgf/decoration automaton/switch if input segment less than=<dimension> to <new state>` (no default)

When this key is encountered, PGF checks whether the remaining distance to the end of the current input segment of the input path is less than *<dimension>*. If so, an immediate state switch to *<new state>* occurs.

`/pgf/decoration automaton/width=<dimension>` (no default)

First, this option causes an immediate switch to the state `final` if the remaining distance on the input path is less than *<dimension>*. The effect is the same as if you had said `switch if less than=<dimension> to final` just before the `width` option.

If no switch occurs, this option tells PGF the width of the segment. The current point will travel along the input path (as described earlier) by this distance.

`/pgf/decoration automaton/repeat state=<repetitions>` (no default, initially 0)

Tells PGF how long the automaton stays “normally” in the current state. This count is reset to *<repetitions>* each time one of the `switch if` keys causes a state switch. If no state switches occur, the *<code>* is executed and the repetition counter is decreased. Then, there is once more a chance of a state change caused by any of the *<options>*. If no repetition occurs, the *<code>* is executed once more and the counter is decreased once more. When the counter reaches zero, the *<code>* is executed once more, but, then, a different state is entered, as specified by the `next state` option.

Note, that the maximum number of times the state will be executed is *<repetitions>* + 1.

`/pgf/decoration automaton/next state=<new state>` (no default)

After the *<code>* for state has been executed for the last time, a state switch to *<new state>* is performed. If this option is not given, the next state is the same as the current state.

`/pgf/decoration automaton/if input segment is closepath=<options>` (no default)

This key checks whether the current input segment is a closepath operation. If so, the *<options>* get executed; otherwise nothing happens. You can use this option to handle a closepath in some special way, for instance, switching to a new state in which `\pgfpathclose` is executed.

`/pgf/decoration automaton/auto end on length=<dimension>` (no default)

This key is just included for convenience, it does nothing that cannot be achieved using the previous options. The effect is the following: If the remaining input path’s length is at most *<dimension>*, the decorated path is ended with a straight line to the end of the input path and, possibly, it is closed, namely if the input path ended with a closepath operation. Otherwise, it is checked whether the current input segment is a closepath segment and whether the remaining distance on the current input segment is at most *<distance>*. If so, the a closepath operation is used to close the decorated path and the automaton continues with the next subpath, remaining in the current state.

In all other cases, nothing happens.

`/pgf/decoration automaton/auto corner on length=<dimension>` (no default)

This key has the following effect: Firstly, the  $\TeX$ -if `\ifpgfdecorationpathhascorners` is false, nothing happens. Otherwise, it is tested whether the remaining distance on the current input segment is at most *<dimension>*. If so, a `lineto` operation is used to reach the end of this input segment and the automaton continues with the next input segment, but remains in the current state.

The main idea behind this option is to avoid having decoration segments “overshoot” past a corner.

You may sometimes wish to do computations outside the transformational  $\TeX$ -group of the current segment, so that these results of these computations are available in the next state. For this, the following two options are useful:

`/pgf/decoration automaton/persistent precomputation=<precode>` (no default)

If the *<code>* of state is executed, the *<precode>* is executed first and it executed outside the  $\TeX$ -group of the *<code>*. Note that when the *<precode>* is executed, the transformation matrix is not setup.

`/pgf/decoration automaton/persistent postcomputation=<postcode>` (no default)

Works like the `persistent precomputation` option, only the *<postcode>* is executed after (and also outside) the  $\TeX$ -group of the main *<code>*.

There are a number of macros and dimensions which may be useful inside a decoration automaton. The following macros are available:

`\pgfdecoratedpathlength`

The length of the input path. If the input path consists of several input segments, this number is the sum of the lengths of the input segments.

**`\pgfdecoratedinputsegmentlength`**

The length of the current input segment of the input path. “Current input segment” refers to the input segment on which the current point lies.

**`\pgfpointdecoratedpathlast`**

The final point of the input path.

**`\pgfpointdecoratedinputsegmentlast`**

The final point of the current input segment of the input path.

**`\pgfdecoratedangle`**

The angle of the tangent to the decorated path at the *origin* of the current segment. The transformation matrix applied at the beginning of a state includes a rotation equivalent to this angle.

The following T<sub>E</sub>X dimension registers are also available inside the automaton:

**`\pgfdecoratedremainingdistance`**

The remaining distance on the input path.

**`\pgfdecoratedcompleteddistance`**

The completed distance on the input path.

**`\pgfdecoratedinputsegmentremainingdistance`**

The remaining distance on the current input segment of the input path.

**`\pgfdecoratedinputsegmentcompleteddistance`**

The completed distance on the current input segment of the input path.

Further keys and macros are defined and used by the decoration libraries, see Section 29.

The following example shows how these options can be used:

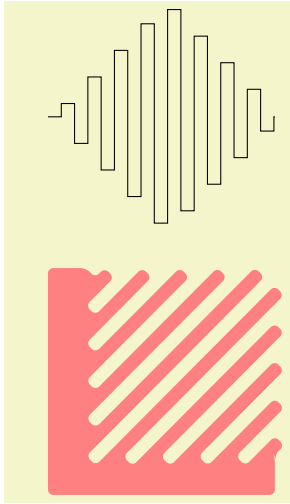

```

\pgfdeclaredecoration{complicated example decoration}{initial}
{
  \state{initial}[width=5pt,next state=up]
  { \pgfpathlineto{\pgfpoint{5pt}{0pt}} }

  \state{up}[width=5pt,next state=down]
  {
    \ifdim\pgfdecoratedremainingdistance>\pgfdecoratedcompleteddistance
      % Growing
      \pgfpathlineto{\pgfpoint{0pt}{\pgfdecoratedcompleteddistance}}
      \pgfpathlineto{\pgfpoint{5pt}{\pgfdecoratedcompleteddistance}}
      \pgfpathlineto{\pgfpoint{5pt}{0pt}}
    \else
      % Shrinking
      \pgfpathlineto{\pgfpoint{0pt}{\pgfdecoratedremainingdistance}}
      \pgfpathlineto{\pgfpoint{5pt}{\pgfdecoratedremainingdistance}}
      \pgfpathlineto{\pgfpoint{5pt}{0pt}}
    \fi%
  }
  \state{down}[width=5pt,next state=up]
  {
    \ifdim\pgfdecoratedremainingdistance>\pgfdecoratedcompleteddistance
      % Growing
      \pgfpathlineto{\pgfpoint{0pt}{-\pgfdecoratedcompleteddistance}}
      \pgfpathlineto{\pgfpoint{5pt}{-\pgfdecoratedcompleteddistance}}
      \pgfpathlineto{\pgfpoint{5pt}{0pt}}
    \else
      % Shrinking
      \pgfpathlineto{\pgfpoint{0pt}{-\pgfdecoratedremainingdistance}}
      \pgfpathlineto{\pgfpoint{5pt}{-\pgfdecoratedremainingdistance}}
      \pgfpathlineto{\pgfpoint{5pt}{0pt}}
    \fi%
  }
  \state{final}
  {
    \pgfpathlineto{\pgfpointdecoratedpathlast}
  }
}
\begin{tikzpicture}[decoration=complicated example decoration]
  \draw decorate{ (0,0) -- (3,0)};
  \fill [red!50,rounded corners=2pt]
    decorate {(.5,-2) -- ++(2.5,-2.5)} -- (3,-5) -| (0,-2) -- cycle;
\end{tikzpicture}

```

### 72.3.1 Predefined Decorations

The three decorations `moveto`, `lineto`, and `curveto` are predefined and “always available.” They are mostly useful in conjunction with meta-decorations. They are documented in Section 29 alongside the other decorations.

## 72.4 Using Decorations

Once a decoration has been declared, it can be used.

```

\begin{pgfdecoration}{\langle decoration list \rangle}
  \langle environment contents \rangle
\end{pgfdecoration}

```

The  $\langle environment\ contents \rangle$  should contain commands for creating an path. This path is the basis for the *input paths* for the decorations in the  $\langle decoration\ list \rangle$ . In detail, the following happens:

1. The preexisting unused path is saved.
2. The path commands specified in  $\langle environment\ contents \rangle$  are executed and this resulting path is saved. The path is then divided into different *input paths* as follows: The format for each item in  $\langle decoration\ list \rangle$  is

$$\langle decoration \rangle \langle length \rangle \langle before\ code \rangle \langle after\ code \rangle$$

The  $\langle before\ code \rangle$  and the  $\langle after\ code \rangle$  are optional. The input path is divided into input paths as follows: The first input path consists of the first lines of the path specified in the  $\langle environment$

*contents*) until the *length* of the first element of the *decoration list* is reached. If this length is reached in the middle of a line, the line is broken up at this exact position. Then the second input path has the *length* of the second element in the *decoration list* and consists of the lines making up the following *length* part of the path in the *environment contents*, and so on.

If the lengths in the *decoration list* do not add up to the total length of the path in the *environment contents*, either some decorations are dropped (if their lengths add up to more than the length of the *environment contents*) or the input path is not fully used (if their lengths add up to less).

3. The preexisting path is reinstalled.
4. The decoration automata move along the input paths, thus creating (and possibly using) the output paths. These output paths extend (unless they are used) the current path.

Some important points should be noted regarding the use of this environment:

- If *environment contents* does not begin with `\pgfpathmoveto`, the last known point on the pre-existing path is assumed as the starting point.
- All except the last of any sequence of consecutive move-to commands in *environment contents* are discarded.
- Any move-to commands at end of *environment contents* are ignored.
- Any close-path commands on the input path are interpreted as straight lines. Internally something a little more complicated is going on, however, a closed path on the input path has no effect on the output path, other than causing the automaton to travel in a straight line towards the location of the last move-to command on the input path.
- Although tangent computations for the input path work with the last point on the preexisting path, no automatic move-to operations are issued for the output path. If an output path commences with a line-to or curve-to when the existing path is empty, an appropriate move-to command should be inserted before the decoration commences.
- If a decoration uses its own path, the first time this happens the preexisting path is part of the path that is used at this point.

When the decoration automata “work on” their respective input paths, before the automaton starts, *before code* is executed. After the decoration automaton has finished, *after code* is executed.

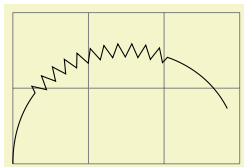

```
\begin{tikzpicture}[decoration={segment length=5pt}]
  \draw [help lines] grid (3,2);
  \begin{pgfdecoration}{\curveto}{1cm},{zigzag}{2cm},{curveto}{1cm}}
    \pgfpathmoveto{\pgfpointorigin}
    \pgfpathcurveto
      {\pgfpoint{0cm}{2cm}}{\pgfpoint{3cm}{2cm}}{\pgfpoint{3cm}{0cm}}
    \end{pgfdecoration}
  \pgfusepath{stroke}
\end{tikzpicture}
```

When the lengths are evaluated, the dimension `\pgfdecoratedremainingdistance` holds the remaining distance on the entire decorated path, and `\pgfdecoratedpathlength` holds the total length of the path. Thus, it is possible to specify lengths like `\pgfdecoratedpathlength/3`.

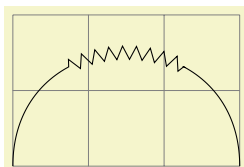

```
\begin{tikzpicture}[decoration={segment length=5pt}]
  \draw [help lines] grid (3,2);
  \begin{pgfdecoration}{
    {curveto}{\pgfdecoratedpathlength/3},
    {zigzag}{\pgfdecoratedpathlength/3},
    {curveto}{\pgfdecoratedremainingdistance}
  }
    \pgfpathmoveto{\pgfpointorigin}
    \pgfpathcurveto
      {\pgfpoint{0cm}{2cm}}{\pgfpoint{3cm}{2cm}}{\pgfpoint{3cm}{0cm}}
    \end{pgfdecoration}
  \pgfusepath{stroke}
\end{tikzpicture}
```

When *before code* is executed, the following macro is useful:

### `\pgfpointdecoratedpathfirst`

Returns the point corresponding to the start of the current input path.

When *<after code>* is executed, the following macro can be used:

### `\pgfpointdecoratedpathlast`

Returns the point corresponding to the end of the current input path.

This means that if decorations do not use their own path, it is possible to do something with them and and continue from the correct place.

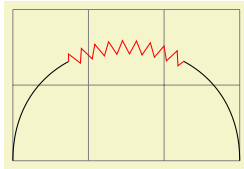

```
\begin{tikzpicture}
\draw [help lines] grid (3,2);
\begin{pgfdecoration}{
  {curveto}{\pgfdecoratedpathlength/3}
  {}
  {
    \pgfusepath{stroke}
  },
  {zigzag}{\pgfdecoratedpathlength/3}
  {
    \pgfpathmoveto{\pgfpointdecoratedpathfirst}
    \pgfdecorationsegmentlength=5pt
  }
  {
    \pgfsetstrokecolor{red}
    \pgfusepath{stroke}
    \pgfpathmoveto{\pgfpointdecoratedpathlast}
    \pgfsetstrokecolor{black}
  },
  {curveto}{\pgfdecoratedremainingdistance}
}
\pgfpathmoveto{\pgfpointorigin}
\pgfpathcurveto
  {\pgfpoint{0cm}{2cm}}{\pgfpoint{3cm}{2cm}}{\pgfpoint{3cm}{0cm}}
\end{pgfdecoration}
\pgfusepath{stroke}
\end{tikzpicture}
```

After the `{decoration}` environment has finished, the following macros are available:

### `\pgfdecorateexistingpath`

The preexisting path before the environment was entered.

### `\pgfdecoratedpath`

The (total) input path (that is, the path created by the environment contents).

### `\pgfdecorationpath`

The output path. If the path is used, this macro contains only the last unused part of the output path.

### `\pgfpointdecoratedpathlast`

The final point of the input path.

### `\pgfpointdecorationpathlast`

The final point of the output path.

The following style is executed each time a decoration is used. You may use it to setup default options for decorations.

### `/pgf/every decoration`

(style, initially empty)

This style is executed for every decoration.

```
\pgfdecoration{<name>}
  <environment contents>
```

### `\endpgfdecoration`

The plain- $\text{\TeX}$  version of the `{pgfdecorate}` environment.

### `\startpgfdecoration{<name>}`

*<environment contents>*

### `\stoppgfdecoration`

The Con $\text{\TeX}$ t version of the `{pgfdecoration}` environment.

For convenience, the following macros provide a “shorthand” for decorations (internally, they all use the `{pgfdecoration}` environment).

### `\pgfdecoratepath{<name>}{<path commands>}`

Decorate the path described by *<path commands>* with the decoration *<name>*. This is equivalent to

```
\pgfdecorate{<name>{\pgfdecoratedpathlength}
               {\pgfdecoratebeforecode}{\pgfdecorateaftercode}}
// the path commands.
\endpgfdecorate
```

### `\pgfdecoratecurrentpath{<name>}`

Decorate the preexisting path with the decoration *<name>*.

Both the above commands use the current definitions of the following macros:

### `\pgfdecoratebeforecode`

Code executed as *<before code>*, see the description of `\pgfdecorate`.

### `\pgfdecorateaftercode`

Code executed as *<after code>*, see the description of `\pgfdecorate`.

It may sometimes be useful to add an additional transformation for each segment of a decoration. The following command allows you to define such a “last minute transformation.”

### `\pgfsetdecorationsegmenttransformation{<code>}`

The *<code>* will be executed at the very beginning of each segment. Note when applying multiple decorations, this will be reset between decorations, so it needs to be specified for each segment.

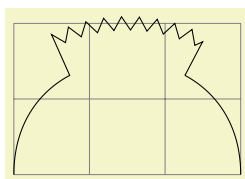

```
\begin{tikzpicture}
\draw [help lines] grid (3,2);
\begin{pgfdecoration}{
  {curveto}{\pgfdecoratedpathlength/3},
  {zigzag}{\pgfdecoratedpathlength/3}
  {
    \pgfdecorationsegmentlength=5pt
    \pgfsetdecorationsegmenttransformation{\pgftransformyshift{.5cm}}
  },
  {curveto}{\pgfdecoratedremainingdistance}
}
\pgfpathmoveto{\pgfpointorigin}
\pgfpathcurveto
  {\pgfpoint{0cm}{2cm}}{\pgfpoint{3cm}{2cm}}{\pgfpoint{3cm}{0cm}}
\end{pgfdecoration}
\pgfusepath{stroke}
\end{tikzpicture}
```

## 72.5 Meta-Decorations

A meta-decoration provides an alternative way to decorate a path with multiple decorations. It is, in essence, an automaton that decorates an input path with decoration automatons. In general, however, the end effect is still that a path is decorated with other paths, and the input path should be thought of as being divided into sub-input-paths, each with their own decoration. Like ordinary decorations, before a meta-decoration can be used it must be declared.



### 72.5.1 Declaring Meta-Decorations

`\pgfdeclaremetadecorate`{*<name>*}{*<initial state>*}{*<states>*}

This command declares a new meta-decoration called *<name>*. The *<states>* argument contains a description of the meta-decoration automaton's states and the transitions between them. The *<initial state>* is the state in which the automaton starts.

The `\state` command is similar to the one found in decoration declarations, and takes the same form:

`\state`{*<name>*}[*<options>*]{*<code>*}

Declares the state *<name>* inside the current meta-decoration automaton. Unlike decorations, states in meta-decorations are not executed within a group, which makes the persistent computation options superfluous. Consider using an initial state with `width=0pt` to do precalculations that could speed the execution of the meta-decoration.

The *<options>* are executed with the key path set to `/pgf/meta-decorations automaton/`, and the following keys are defined for this path:

`/pgf/meta-decoration automaton/switch if less than`=*<dimension>* to *<new state>* (no default)

This causes PGF to check whether the remaining distance to the end of the input path is less than *<dimension>*, and, if so, to immediately switch to the state *<new state>*. When this key is evaluated, the macro `\pgfmetadecoratedpathlength` will be defined as the total length of the decoration path, allowing for values such as `\pgfmetadecoratedpathlength/8`.

`/pgf/meta-decoration automaton/width`=*<dimension>* (no default)

As always, this option will cause an immediate switch to the state `final` if the remaining distance on the input path is less than *<dimension>*.

Otherwise, this option tells PGF the width of the “meta-segment”, that is, the length of the sub-input-path which the decoration automaton specified in *<code>* will decorate.

`/pgf/meta-decoration automaton/next state`=*<new state>* (no default)

After the code for a state has been executed, a state switch to *<new state>* is performed. If this option is not given, the next state is the same as the current state.

The code in *<code>* is quite different from the code in a decoration state. In almost all cases only the following three macros will be required:

`\decoration`{*<name>*}

This sets the decoration for the current state to *<name>*. If this command is omitted, the `moveto` decoration will be used.

`\beforedecoration`{*<before code>*}

Defines *<before code>* as (typically) PGF commands to be executed before the decoration is applied to the current segment. This command can be omitted. If you wish to set up some decoration specific parameters such as segment length, or segment amplitude, then they can be set in *<before code>*.

`\afterdecoration`{*<after code>*}

Defines *<after code>* as commands to be executed after the decoration has been applied to the current segment. This command can be omitted.

There are some macros that may be useful when creating meta-decorations (note that they are all macros):

`\pgfpointmetadecoratedpathfirst`

When the *<before code>* is executed, this macro stores the first point on the current sub-input-path.

`\pgfpointmetadecoratedpathlast`

When the *<after code>* is executed, this macro stores the last point on the current sub-input-path.

`\pgfmetadecoratedpathlength`

The entire length of the entire input path.



*environment contents*  
`\end{pgfmetadecoration}`

This environment decorates the input path described in *environment contents*, with the meta-decoration *name*.

`\pgfmetadecoration{name}`  
*environment contents*  
`\endpgfmetadecoration`

The plain T<sub>E</sub>X version of the `{pgfmetadecoration}` environment.

`\startpgfmetadecoration{name}`  
*environment contents*  
`\stoppgfmetadecoration`

The ConT<sub>E</sub>Xt version of the `{pgfmetadecoration}` environment.

## 73 Using Paths

### 73.1 Overview

Once a path has been constructed, it can be *used* in different ways. For example, you can draw the path or fill it or use it for clipping.

Numerous graph parameters influence how a path will be rendered. For example, when you draw a path, the line width is important as well as the dashing pattern. The options that govern how paths are rendered can all be set with commands starting with `\pgfset`. *All options that influence how a path is rendered always influence the complete path.* Thus, it is not possible to draw part of a path using, say, a red color and drawing another part using a green color. To achieve such an effect, you must use two paths.

In detail, paths can be used in the following ways:

1. You can *stroke* (also known as *draw*) a path.
2. You can *fill* a path with a uniform color.
3. You can *clip* subsequent renderings against the path.
4. You can *shade* a path.
5. You can *use the path as bounding box* for the whole picture.

You can also perform any combination of the above, though it makes no sense to fill and shade a path at the same time.

To perform (a combination of) the first three actions, you can use the following command:

`\pgfusepath{⟨actions⟩}`

Applies the given `⟨actions⟩` to the current path. Afterwards, the current path is (globally) empty. The following actions are possible:

- **fill** fills the path. See Section 73.3 for further details.



```
\begin{pgfpicture}
  \pgfpathmoveto{\pgfpointorigin}
  \pgfpathlineto{\pgfpoint{1cm}{1cm}}
  \pgfpathlineto{\pgfpoint{1cm}{0cm}}
  \pgfusepath{fill}
\end{pgfpicture}
```

- **stroke** strokes the path. See Section 73.2 for further details.



```
\begin{pgfpicture}
  \pgfpathmoveto{\pgfpointorigin}
  \pgfpathlineto{\pgfpoint{1cm}{1cm}}
  \pgfpathlineto{\pgfpoint{1cm}{0cm}}
  \pgfusepath{stroke}
\end{pgfpicture}
```

- **clip** clips all subsequent drawings against the path. See Section 73.4 for further details.



```
\begin{pgfpicture}
  \pgfpathmoveto{\pgfpointorigin}
  \pgfpathlineto{\pgfpoint{1cm}{1cm}}
  \pgfpathlineto{\pgfpoint{1cm}{0cm}}
  \pgfusepath{stroke,clip}
  \pgfpathcircle{\pgfpoint{1cm}{1cm}}{0.5cm}
  \pgfusepath{fill}
\end{pgfpicture}
```

- **discard** discards the path, that is, it is not used at all. Giving this option (alone) has the same effect as giving an empty options list.

When more than one of the first three actions are given, they are applied in the above ordering, regardless of their ordering in `⟨actions⟩`. Thus, `{stroke,fill}` and `{fill,stroke}` have the same effect.

To shade a path, use the `\pgfshadepath` command, which is explained in Section 83.

## 73.2 Stroking a Path

When you use `\pgfusepath{stroke}` to stroke a path, several graphic parameters influence how the path is drawn. The commands for setting these parameters are explained in the following.

Note that all graphic parameters apply to the path as a whole, never only to a part of it.

All graphic parameters are local to the current `{pgfscope}`, but they persists past `TEX` groups, *except* for the interior rule (even-odd or nonzero) and the arrow tip kinds. The latter graphic parameters only persist till the end of the current `TEX` group, but this may change in the future, so do not count on this.

### 73.2.1 Graphic Parameter: Line Width

`\pgfsetlinewidth{⟨line width⟩}`

This command sets the line width for subsequent strokes (in the current `pgfscope`). The line width is given as a normal `TEX` dimension like `0.4pt` or `1mm`.



```
\begin{pgfpicture}
  \pgfsetlinewidth{1mm}
  \pgfpathmoveto{\pgfpoint{0mm}{0mm}}
  \pgfpathlineto{\pgfpoint{2cm}{0mm}}
  \pgfusepath{stroke}
  \pgfsetlinewidth{2\pgflinewidth} % double in size
  \pgfpathmoveto{\pgfpoint{0mm}{5mm}}
  \pgfpathlineto{\pgfpoint{2cm}{5mm}}
  \pgfusepath{stroke}
\end{pgfpicture}
```

`\pgflinewidth`

You can access the current line width via the `TEX` dimension `\pgflinewidth`. It will be set to the correct line width, that is, even when a `TEX` group closed, the value will be correct since it is set globally, but when a `{pgfscope}` closes, the value is set to the correct value it had before the scope.

### 73.2.2 Graphic Parameter: Caps and Joins

`\pgfsetbuttcap`

Sets the line cap to a butt cap. See Section 15.3.1 for an explanation of what this is.

`\pgfsetroundcap`

Sets the line cap to a round cap. See again Section 15.3.1.

`\pgfsetrectcap`

Sets the line cap to a square cap. See again Section 15.3.1.

`\pgfsetroundjoin`

Sets the line join to a round join. See again Section 15.3.1.

`\pgfsetbeveljoin`

Sets the line join to a bevel join. See again Section 15.3.1.

`\pgfsetmiterjoin`

Sets the line join to a miter join. See again Section 15.3.1.

`\pgfsetmiterlimit{⟨miter limit factor⟩}`

Sets the miter limit to `⟨miter limit factor⟩`. See again Section 15.3.1.

### 73.2.3 Graphic Parameter: Dashing

`\pgfsetdash{⟨list of even length of dimensions⟩}{⟨phase⟩}`

Sets the dashing of a line. The first entry in the list specifies the length of the first solid part of the list. The second entry specifies the length of the following gap. Then comes the length of the second solid part, following by the length of the second gap, and so on. The `⟨phase⟩` specifies where the first solid part starts relative to the beginning of the line.

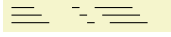

```

\begin{pgfpicture}
  \pgfsetdash{{0.5cm}{0.5cm}{0.1cm}{0.2cm}}{0cm}
  \pgfpathmoveto{\pgfpoint{0mm}{0mm}}
  \pgfpathlineto{\pgfpoint{2cm}{0mm}}
  \pgfusepath{stroke}
  \pgfsetdash{{0.5cm}{0.5cm}{0.1cm}{0.2cm}}{0.1cm}
  \pgfpathmoveto{\pgfpoint{0mm}{1mm}}
  \pgfpathlineto{\pgfpoint{2cm}{1mm}}
  \pgfusepath{stroke}
  \pgfsetdash{{0.5cm}{0.5cm}{0.1cm}{0.2cm}}{0.2cm}
  \pgfpathmoveto{\pgfpoint{0mm}{2mm}}
  \pgfpathlineto{\pgfpoint{2cm}{2mm}}
  \pgfusepath{stroke}
\end{pgfpicture}

```

Use `\pgfsetdash{}{0pt}` to get a solid dashing.

### 73.2.4 Graphic Parameter: Stroke Color

`\pgfsetstrokecolor{<color>}`

Sets the color used for stroking lines to *<color>*, where *<color>* is a L<sup>A</sup>T<sub>E</sub>X color like `red` or `black!20!red`. Unlike the `\color` command, the effect of this command lasts till the end of the current `{pgfscope}` and not till the end of the current T<sub>E</sub>X group.

The color used for stroking may be different from the color used for filling. However, a `\color` command will always “immediately override” any special settings for the stroke and fill colors.

In plain T<sub>E</sub>X, this command will also work, but the problem of *defining* a color arises. After all, plain T<sub>E</sub>X does not provide L<sup>A</sup>T<sub>E</sub>X colors. For this reason, PGF implements a minimalistic “emulation” of the `\definecolor`, `\colorlet`, and `\color` commands. Only gray-scale and rgb colors are supported. For most cases this turns out to be enough.



```

\begin{pgfpicture}
  \pgfsetlinewidth{1pt}
  \color{red}
  \pgfpathcircle{\pgfpoint{0cm}{0cm}}{3mm} \pgfusepath{fill,stroke}
  \pgfsetstrokecolor{black}
  \pgfpathcircle{\pgfpoint{1cm}{0cm}}{3mm} \pgfusepath{fill,stroke}
  \color{red}
  \pgfpathcircle{\pgfpoint{2cm}{0cm}}{3mm} \pgfusepath{fill,stroke}
\end{pgfpicture}

```

`\pgfsetcolor{<color>}`

Sets both the stroke and fill color. The difference to the normal `\color` command is that the effect lasts till the end of the current `{pgfscope}`, not only till the end of the current T<sub>E</sub>X group.

### 73.2.5 Graphic Parameter: Stroke Opacity

You can set the stroke opacity using `\pgfsetstrokeopacity`. This command is described in Section 84.

### 73.2.6 Graphic Parameter: Arrows

After a path has been drawn, PGF can add arrow tips at the ends. It will only add arrows at the beginning of the first subpath and at the end of the last subpath. For closed paths the result is not defined, that is, it may change without notice in the future.

`\pgfsetarrowsstart{<arrow kind>}`

Sets the arrow tip kind used at the start of a (possibly curved) path. When this option is used, the line will often be slightly shortened to ensure that the tip of the arrow will exactly “touch” the “real” start of the line.

To “clear” the start arrow, say `\pgfsetarrowsstart{}`.



```
\begin{pgfpicture}
  \pgfsetarrowsstart{latex}
  \pgfpathmoveto{\pgfpointorigin}
  \pgfpathlineto{\pgfpoint{1cm}{0cm}}
  \pgfusepath{stroke}
  \pgfsetarrowsstart{to}
  \pgfpathmoveto{\pgfpoint{0cm}{2mm}}
  \pgfpathlineto{\pgfpoint{1cm}{2mm}}
  \pgfusepath{stroke}
\end{pgfpicture}
```

The effect of this command persists only till the end of the current  $\TeX$  scope.

The different possible arrow kinds are explained in Section 74.

**`\pgfsetarrowsend`** $\langle arrow\ kind\rangle$

Sets the arrow tip kind used at the end of a path.



```
\begin{pgfpicture}
  \pgfsetarrowsstart{latex}
  \pgfsetarrowsend{to}
  \pgfpathmoveto{\pgfpointorigin}
  \pgfpathlineto{\pgfpoint{1cm}{0cm}}
  \pgfusepath{stroke}
\end{pgfpicture}
```

**`\pgfsetarrows`** $\langle start\ kind\rangle$ - $\langle end\ kind\rangle$

Sets the start arrow kind to  $\langle start\ kind\rangle$  and the end kind to  $\langle end\ kind\rangle$ .



```
\begin{pgfpicture}
  \pgfsetarrows{latex-to}
  \pgfpathmoveto{\pgfpointorigin}
  \pgfpathlineto{\pgfpoint{1cm}{0cm}}
  \pgfusepath{stroke}
\end{pgfpicture}
```

**`\pgfsetshortenstart`** $\langle dimension\rangle$

This command will shorten the start of every stroked path by the given dimension. This shortening is done in addition to automatic shortening done by a start arrow, but it can be used even if no start arrow is given.

This command is useful if you wish arrows or lines to “stop shortly before” a given point.

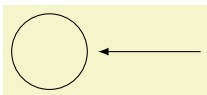

```
\begin{pgfpicture}
  \pgfpathcircle{\pgfpointorigin}{5mm}
  \pgfusepath{stroke}
  \pgfsetarrows{latex-}
  \pgfsetshortenstart{4pt}
  \pgfpathmoveto{\pgfpoint{5mm}{0cm}} % would be on the circle
  \pgfpathlineto{\pgfpoint{2cm}{0cm}}
  \pgfusepath{stroke}
\end{pgfpicture}
```

**`\pgfsetshortenend`** $\langle dimension\rangle$

Works like `\pgfsetshortenstart`.

### 73.2.7 Inner Lines

When a path is stroked, it is possible to request that it is stroked twice, the second time with a different line width and a different color. This is a useful effect for creating “double” lines, for instance by setting the line width to 2pt and stroking a black line and then setting the inner line width to 1pt and stroking a white line on the same path as the original path. This results in what looks like two lines, each of thickness 0.5pt, spaces 1pt apart.

You may wonder why there is direct support for this “double stroking” in the basic layer. After all, this effect is easy to achieve “by hand”. The main reason is that arrow tips must be treated in a special manner

when such “double lines” are present. First, the order of actions is important: First, the (thick) main line should be stroked, then the (thin) inner line, and only then should the arrow tip be drawn. Second, the way an arrow tip looks typically depends strongly on the width of the inner line, so the arrow tip code, which is part of the basic layer, needs access to the inner line thickness.

Two commands are used to set the inner line width and color.

`\pgfsetinnerlinewidth{ $\langle dimension \rangle$ }`

This command sets the width of the inner line. Whenever a path is stroked (and only then), it will be stroked normally and, afterward, it is stroked once more with the color set to the inner line color and the line width set to  $\langle dimension \rangle$ .

In case arrow tips are added to a path, the path is first stroked normally, then the inner line is stroked, and then the arrow tip is added. In case the main path is shortened because of the added arrow tip, this shortened path is double stroked, not the original path (which is exactly what you want).

When the inner line width is set to 0pt, which is the default, no inner line is stroked at all (not even a line of width 0pt). So, in order to “switch off” double stroking, set  $\langle dimension \rangle$  to 0pt.

The setting of the inner line width is local to the current  $\text{\TeX}$  group and *not* to the current PGF scope. Note that inner lines will *not* be drawn for paths that are also used for clipping. However, this may change in the future, so you should not depend on this.

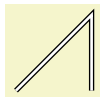

```
\begin{pgfpicture}
  \pgfpathmoveto{\pgfpointorigin}
  \pgfpathlineto{\pgfpoint{1cm}{1cm}}
  \pgfpathlineto{\pgfpoint{1cm}{0cm}}
  \pgfsetlinewidth{2pt}
  \pgfsetinnerlinewidth{1pt}
  \pgfusepath{stroke}
\end{pgfpicture}
```

`\pgfsetinnerstrokecolor{ $\langle color \rangle$ }`

This command sets the  $\langle color \rangle$  that is to be used when the inner line is stroked. The effect of this command is also local to the current  $\text{\TeX}$  group.



```
\begin{pgfpicture}
  \pgfpathmoveto{\pgfpointorigin}
  \pgfpathlineto{\pgfpoint{1cm}{1cm}}
  \pgfpathlineto{\pgfpoint{1cm}{0cm}}
  \pgfsetlinewidth{2pt}
  \pgfsetinnerlinewidth{1pt}
  \pgfsetinnerstrokecolor{red!50}
  \pgfusepath{stroke}
\end{pgfpicture}
```

## 73.3 Filling a Path

Filling a path means coloring every interior point of the path with the current fill color. It is not always obvious whether a point is “inside” a path when the path is self-intersecting and/or consists of multiple parts. In this case either the nonzero winding number rule or the even-odd crossing number rule is used to decide, which points lie “inside.” These rules are explained in Section 15.4.

### 73.3.1 Graphic Parameter: Interior Rule

You can set which rule is used using the following commands:

`\pgfseteorule`

Dictates that the even-odd rule is used in subsequent fillings in the current  $\text{\TeX}$  scope. Thus, for once, the effect of this command does not persist past the current  $\text{\TeX}$  scope.

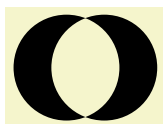

```
\begin{pgfpicture}
  \pgfseteorule
  \pgfpathcircle{\pgfpoint{0mm}{0cm}}{7mm}
  \pgfpathcircle{\pgfpoint{5mm}{0cm}}{7mm}
  \pgfusepath{fill}
\end{pgfpicture}
```



### `\pgfsetnonzerorule`

Dictates that the nonzero winding number rule is used in subsequent fillings in the current  $\text{T}_{\text{E}}\text{X}$  scope. This is the default.

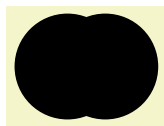

```
\begin{pgfpicture}
  \pgfsetnonzerorule
  \pgfpathcircle{\pgfpoint{0mm}{0cm}}{7mm}
  \pgfpathcircle{\pgfpoint{5mm}{0cm}}{7mm}
  \pgfusepath{fill}
\end{pgfpicture}
```

### 73.3.2 Graphic Parameter: Filling Color

#### `\pgfsetfillcolor{<color>}`

Sets the color used for filling paths to  $\langle color \rangle$ . Like the stroke color, the effect lasts only till the next use of `\color`.

### 73.3.3 Graphic Parameter: Fill Opacity

You can set the fill opacity using `\pgfsetfillopacity`. This command is described in Section 84.

## 73.4 Clipping a Path

When you add the `clip` option, the current path is used for clipping subsequent drawings. The same rule as for filling is used to decide whether a point is inside or outside the path, that is, either the even-odd rule or the nonzero rule.

Clipping never enlarges the clipping area. Thus, when you clip against a certain path and then clip again against another path, you clip against the intersection of both.

The only way to enlarge the clipping path is to end the `{pgfscope}` in which the clipping was done. At the end of a `{pgfscope}` the clipping path that was in force at the beginning of the scope is reinstalled.

## 73.5 Using a Path as a Bounding Box

When you add the `use as bounding box` option, the bounding box of the picture will be enlarged such that the path is encompassed, but any *subsequent* paths of the current  $\text{T}_{\text{E}}\text{X}$  scope will not have any effect on the size of the bounding box. Typically, you use this command at the very beginning of a `{pgfpicture}` environment.

Left  right.

```
Left
\begin{pgfpicture}
  \pgfpathrectangle{\pgfpointorigin}{\pgfpoint{2ex}{1ex}}
  \pgfusepath{use as bounding box} % draws nothing

  \pgfpathcircle{\pgfpointorigin}{2ex}
  \pgfusepath{stroke}
\end{pgfpicture}
right.
```

## 74 Arrow Tips

### 74.1 Overview

#### 74.1.1 When Does PGF Draw Arrow Tips?

PGF offers an interface for placing *arrow tips* at the end of lines. The interface works as follows:

1. You (or someone else) assigns a name to a certain kind of arrow tips. For example, the arrow tip `latex` is the arrow tip used by the standard  $\LaTeX$  picture environment; the arrow tip `to` looks like the tip of the arrow in  $\TeX$ 's `\to` command; and so on.

This is done once at the beginning of the document.

2. Inside some picture, at some point you specify that in the current scope from now on you would like tips of, say, kind `to` to be added at the end and/or beginning of all paths.

When an arrow kind has been installed and when PGF is about to stroke a path, the following things happen:

- (a) The beginning and/or end of the path is shortened appropriately.
- (b) The path is stroked.
- (c) The arrow tip is drawn at the beginning and/or end of the path, appropriately rotated and appropriately resized.

In the above description, there are a number of “appropriately.” The exact details are not quite trivial and described later on.

#### 74.1.2 Meta-Arrow Tips

In PGF, arrows are “meta-arrows” in the same way that fonts in  $\TeX$  are “meta-fonts.” When a meta-arrow is resized, it is not simply scaled, but a possibly complicated transformation is applied to the size.

A meta-font is not one particular font at a specific size with a specific stroke width (and with a large number of other parameters being fixed). Rather, it is a “blueprint” (actually, more like a program) for generating such a font at a particular size and width. This allows the designer of a meta-font to make sure that, say, the font is somewhat thicker and wider at very small sizes. To appreciate the difference: Compare the following texts: “Berlin” and “**Berlin**”. The first is a “normal” text, the second is the tiny version scaled by a factor of two. Obviously, the first look better. Now, compare “Berlin” and “**Berlin**”. This time, the normal text was scaled down, while the second text is a “normal” tiny text. The second text is easier to read.

PGF’s meta-arrows work in a similar fashion: The shape of an arrow tip can vary according to the line width of the arrow tip is used. Thus, an arrow tip drawn at a line width of 5pt will typically *not* be five times as large as an arrow tip of line width 1pt. Instead, the size of the arrow will get bigger only slowly as the line width increases.

To appreciate the difference, here are the `latex` and `to` arrows, as drawn by PGF at four different sizes:

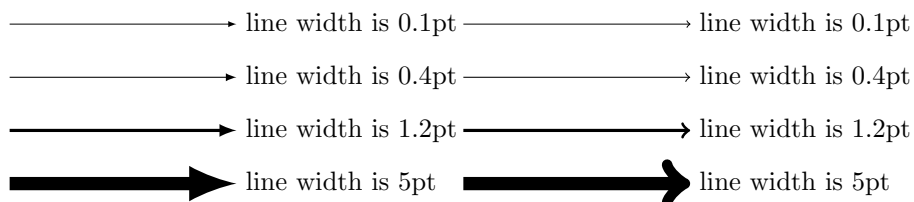

Here, by comparison, is the same arrow when it is simply “resized” (as done by some programs):

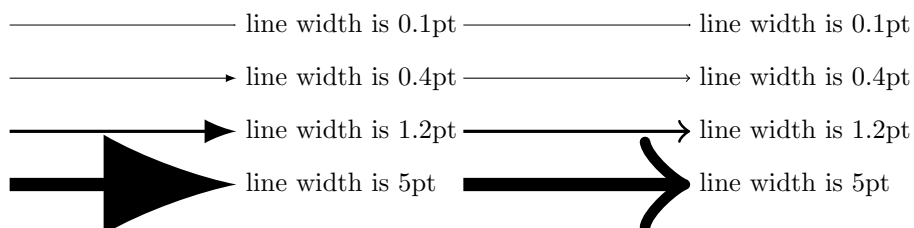

As can be seen, simple scaling produces arrow tips that are way too large at larger sizes and way too small at smaller sizes.

In addition to the line width, other options may also influence the appearance of an arrow tip. In particular, the width of the inner line (the line used to create the effect of a double line) influences arrow tips as well as other options that are specific to the arrow tip.

## 74.2 Declaring an Arrow Tip Kind

To declare an arrow kind “from scratch,” the following command is used:

```
\pgfarrowsdeclare{<start name>}{<end name>}{<extend code>}{<arrow tip code>}
```

This command declares a new arrow kind. An arrow kind has two names, which will typically be the same. When the arrow tip needs to be drawn, the *<arrow tip code>* will be invoked, but the canvas transformation is setup beforehand to a rotation such that when an arrow tip pointing right is specified, the arrow tip that is actually drawn points in the direction of the line.

**Naming the arrow kind.** The *<start name>* is the name used for the arrow tip when it is at the start of a path, the *<end name>* is the name used at the end of a path. For example, the arrow kind that looks like a parenthesis has the *<start name>* ( and the *<end name>* ) so that you can say `\pgfsetarrows{(-)}` to specify that you want parenthesis arrows and both ends.

The *<end name>* and *<start name>* can be quite arbitrary and may contain spaces.

**Basics of the arrow tip code.** Let us next have a look at the *<arrow tip code>*. This code will be used to draw the arrow tip when PGF thinks this is necessary. The code should draw an arrow that “points right,” which means that it should draw an arrow at the end of a line coming from the left and ending at the origin.

As an example, suppose we wanted to declare an arrow tip consisting of two arcs, that is, we want the arrow tip to look more or less like the red part of the following picture:

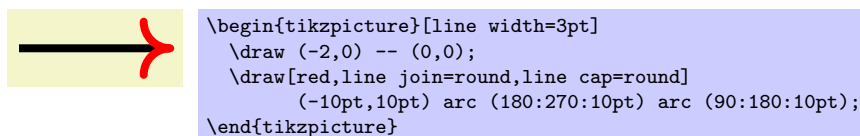

We could use the following as *<arrow tip code>* for this:

```
\pgfarrowsdeclare{arcs}{arcs}{...}
{
\pgfsetdash{}{0pt} % do not dash
\pgfsetroundjoin % fix join
\pgfsetroundcap % fix cap
\pgfpathmoveto{\pgfpoint{-10pt}{10pt}}
\pgfpatharc{180}{270}{10pt}
\pgfpatharc{90}{180}{10pt}
\pgfusepathqstroke
}
```

Indeed, when the ... is set appropriately (in a moment), we can write the following:

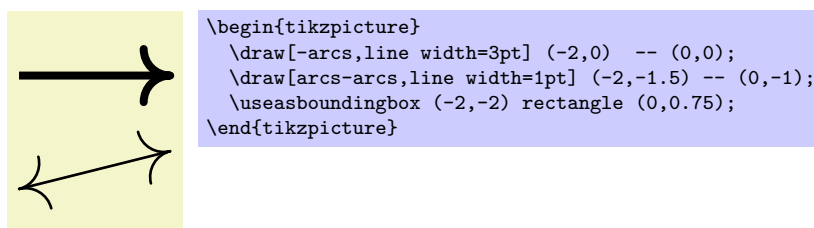

As can be seen in the second example, the arrow tip is automatically rotated as needed when the arrow is drawn. This is achieved by a canvas rotation.

**Special considerations about the arrow tip code.** There are several things you need to be aware of when designing arrow tip code:

- Inside the code, you may not use the `\pgfusepath` command. The reason is that this command internally calls arrow construction commands, which is something you obviously do not want to happen.

Instead of `\pgfusepath`, use the quick versions. Typically, you will use `\pgfusepathqstroke`, `\pgfusepathqfill`, or `\pgfusepathqfillstroke`.

- The code will be executed only once, namely the first time the arrow tip needs to be drawn. The resulting low-level driver commands are protooled and stored away. In all subsequent uses of the arrow tip, the protooled code is directly inserted.
- However, the code will be executed anew for each line width. Thus, an arrow of line width 2pt may result in a different protocol than the same arrow for a line width of 0.4pt.
- If you stroke the path that you construct, you should first set the dashing to solid and setup fixed joins and caps, as needed. This will ensure that the arrow tip will always look the same.
- When the arrow tip code is executed, it is automatically put inside a low-level scope, so nothing will “leak out” from the scope.
- The high-level coordinate transformation matrix will be set to the identity matrix when the code is executed for the first time.

**Designing meta-arrows.** The *⟨arrow tip code⟩* should adjust the size of the arrow in accordance with the line width. For a small line width, the arrow tip should be small, for a large line width, it should be larger. However, the size of the arrow typically *should not* grow in direct proportion to the line width. On the other hand, the size of the arrow head typically *should* grow “a bit” with the line width.

For these reasons, PGF will not simply executed your arrow code within a scaled scope, where the scaling depends on the line width. Instead, your *⟨arrow tip code⟩* is reexecuted again for each different line width.

In our example, we could use the following code for the new arrow tip kind `arc'` (note the prime):

```
\newdimen\arrowsize
\pgfarrowsdeclare{arcs'}{arcs'}{...}
{
  \arrowsize=0.2pt
  \advance\arrowsize by .5\pgflinewidth
  \pgfsetdash{}{0pt} % do not dash
  \pgfsetroundjoin   % fix join
  \pgfsetroundcap    % fix cap
  \pgfpathmoveto{\pgfpoint{-4\arrowsize}{4\arrowsize}}
  \pgfpatharc{180}{270}{4\arrowsize}
  \pgfpatharc{90}{180}{4\arrowsize}
  \pgfusepathqstroke
}
```

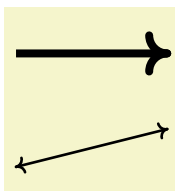

```
\begin{tikzpicture}
  \draw[-arcs',line width=3pt] (-2,0) -- (0,0);
  \draw[arcs'-arcs',line width=1pt] (-2,-1.5) -- (0,-1);
  \useasboundingbox (-2,-1.75) rectangle (0,0.5);
\end{tikzpicture}
```

However, sometimes, it can also be useful to have arrows that do not resize at all when the line width changes. This can be achieved by giving absolute size coordinates in the code, as done for `arc`. On the other hand, you can also have the arrow resize linearly with the line width by specifying all coordinates as multiples of `\pgflinewidth`.

**The left and right extend.** Let us have another look at the exact left and right “ends” of our arrow tip. Let us draw the arrow tip `arc'` at a very large size:

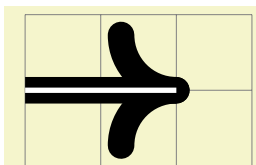

```
\begin{tikzpicture}
  \draw[help lines] (-2,-1) grid (1,1);
  \draw[line width=10pt,-arcs'] (-2,0) -- (0,0);
  \draw[line width=2pt,white] (-2,0) -- (0,0);
\end{tikzpicture}
```

As one can see, the arrow tip does not “touch” the origin as it should, but protrudes a little over the origin. One remedy to this undesirable effect is to change the code of the arrow tip such that everything is shifted half an `\arrowsize` to the left. While this will cause the arrow tip to touch the origin, the line itself will then interfere with the arrow: The arrow tip will be partly “hidden” by the line itself.

PGF uses a different approach to solving the problem: The `<extend code>` argument can be used to “tell” PGF how much the arrow protrudes over the origin. The argument is also used to tell PGF where the “left” end of the arrow is. However, this number is important only when the arrow is being reversed or composed with other arrow tips.

Once PGF knows the right extend of an arrow kind, it can *shorten* lines by this amount when drawing arrows.

Here is a picture that shows what the visualizes the extends. The arrow tip itself is shown in red once more:

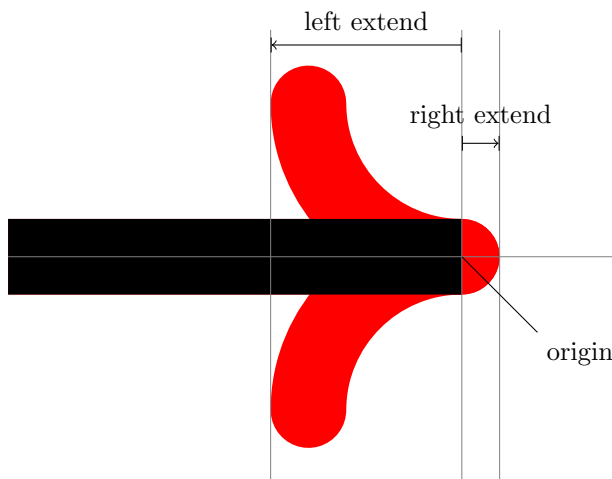

The `<extend code>` is normal  $\TeX$  code that is executed whenever PGF wants to know how far the arrow tip will protrude to the right and left. The code should call the following two commands: `\pgfarrowsrightextend` and `\pgfarrowsleftextend`. Both arguments take one argument that specifies the size. Here is the final code for the `arcs''` arrow tip:

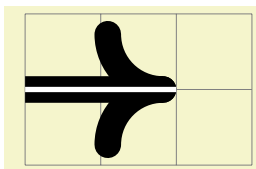

```
\pgfarrowsdeclare{arcs''}{arcs''}
{
  \arrowsize=0.2pt
  \advance\arrowsize by .5\pgflinewidth
  \pgfarrowsleftextend{-4\arrowsize-.5\pgflinewidth}
  \pgfarrowsrightextend{.5\pgflinewidth}
}
{
  \arrowsize=0.2pt
  \advance\arrowsize by .5\pgflinewidth
  \pgfsetdash{}{0pt} % do not dash
  \pgfsetroundjoin % fix join
  \pgfsetroundcap % fix cap
  \pgfpathmoveto{\pgfpoint{-4\arrowsize}{4\arrowsize}}
  \pgfpatharc{180}{270}{4\arrowsize}
  \pgfusepathqstroke
  \pgfpathmoveto{\pgfpointorigin}
  \pgfpatharc{90}{180}{4\arrowsize}
  \pgfusepathqstroke
}
\begin{tikzpicture}
  \draw[help lines] (-2,-1) grid (1,1);
  \draw[line width=10pt,-arcs''] (-2,0) -- (0,0);
  \draw[line width=2pt,white] (-2,0) -- (0,0);
\end{tikzpicture}
```

**Taking inner lines into account.** In addition to the line width, there is another parameter that (may) influence the way an arrow looks: The inner line width, which is the line width of the second line that is stroked on top of a normal line in order to create the effect of a “double” line. When this

line width changes, the arrow tip code is also reexecuted (and cached), so your code may depend on the current value of the inner line width.

The following example shows how this works. The `implies` arrow defined below has to setup the line width not for the “main” line width, but for the main line width minus the inner line width, divided by 2.

```
\pgfarrowsdeclare{implies}{implies}{...}
{
  \pgfmathsetlength{\pgfutil@tempdimb}{.5\pgflinewidth-.5*\pgfinnerlinewidth}%
  \pgfsetlinewidth{\pgfutil@tempdimb}
  \pgfsetdash{}{0pt}
  \pgfsetroundcap
  \pgfsetroundjoin
  \pgfmathsetlength{\pgfutil@tempdima}{.25\pgflinewidth+.25*\pgfinnerlinewidth}%
  \pgfpathmoveto {\pgfpoint{-1.4\pgfutil@tempdima}{2.65\pgfutil@tempdima}}
  \pgfpathcurveto{\pgfpoint{-0.75\pgfutil@tempdima}{1.25\pgfutil@tempdima}}
    {\pgfpoint{1\pgfutil@tempdima}{0.05\pgfutil@tempdima}}
    {\pgfpoint{2\pgfutil@tempdima}{0pt}}
  \pgfpathcurveto{\pgfpoint{1\pgfutil@tempdima}{-0.05\pgfutil@tempdima}}
    {\pgfpoint{-0.75\pgfutil@tempdima}{-1.25\pgfutil@tempdima}}
    {\pgfpoint{-1.4\pgfutil@tempdima}{-2.65\pgfutil@tempdima}}
  \pgfusepathqstroke
}
```

Here is the effect for different combinations of line width and inner line width:

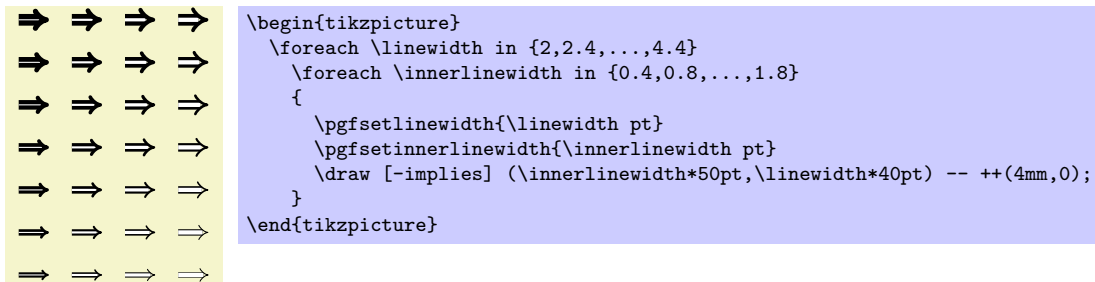

**Arrow options.** You may wish to have further option influence the appearance of an arrow tip. For instance, for a “pointed” arrow you may wish to set the opening angle of the tip. Then, whenever this option changes that arrow tip code also needs to be reexecuted, even though the line width has stayed the same.

You can use the commands `\pgfsetarrowoptions` and `\pgfgetarrowoptions` to set such options for an arrow tip. Whenever an arrow tip needs to be rendered, it is checked whether the arrow tip code has already been executed for the current (expanded) value of the options. If so, the cached code is used; otherwise the code is executed once more. Naturally, inside the code the current value of the arrow options should be taken into account.

Arrow options can and must be specified individually for each arrow type.

In the following example, we make the arc angle an option.

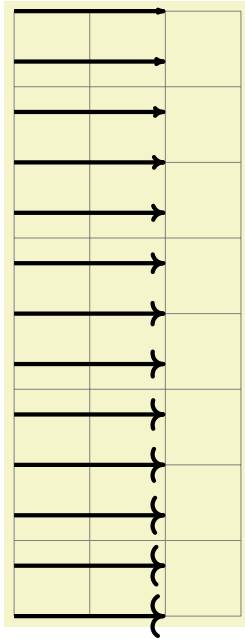

```

\pgfarrowsdeclare{var arc}{var arc} % options is an angle
{
  \arrowsize=0.2pt
  \advance\arrowsize by .5\pgflinewidth
  \pgfarrowslefttextend{-4\arrowsize-.5\pgflinewidth}
  \pgfarrowsrighttextend{.5\pgflinewidth}
}
{
  \arrowsize=0.2pt
  \advance\arrowsize by .5\pgflinewidth
  \pgfsetdash{}{0pt} % do not dash
  \pgfsetroundjoin % fix join
  \pgfsetroundcap % fix cap
  \pgfpathmoveto{\pgfpointorigin}
  \pgfpatharc{-90}{-180+\pgfgetarrowoptions{var arc}}{4\arrowsize}
  \pgfusepathqstroke
  \pgfpathmoveto{\pgfpointorigin}
  \pgfpatharc{90}{180-\pgfgetarrowoptions{var arc}}{4\arrowsize}
  \pgfusepathqstroke
}
\begin{tikzpicture}
  \draw[help lines] (-2,-4) grid (1,4);
  \foreach \option in {-60,-50,...,60}
  {
    \pgfsetarrowoptions{var arc}{\option}
    \draw[ultra thick,-var arc] (-2,\option/15) -- (0,\option/15);
  }
\end{tikzpicture}

```

`\pgfsetarrowoptions{<arrow tip>}{<text>}`

Sets the options for the `<arrow tip>` to `<text>`. The default, before any call to this macro is made, is 0.

`\pgfgetarrowoptions{<arrow tip>}`

This will expand to the current value of the options for the `<arrow tip>`.

### 74.3 Declaring a Derived Arrow Tip Kind

It is possible to declare arrow kinds in terms of existing ones. For these command to work correctly, the left and right extends must be set correctly.

`\pgfarrowsdeclarealias{<start name>}{<end name>}{<old start name>}{<old end name>}`

This command can be used to create an alias (another name) for an existing arrow kind.

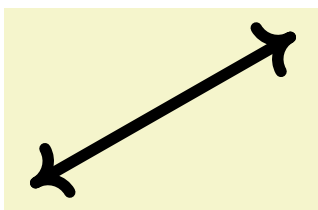

```

\pgfarrowsdeclarealias{<>}{arcs''}{arcs''}%
\begin{tikzpicture}
  \pgfsetarrows{<->}
  \pgfsetlinewidth{1ex}
  \pgfpathmoveto{\pgfpointorigin}
  \pgfpathlineto{\pgfpoint{3.5cm}{2cm}}
  \pgfusepath{stroke}
  \useasboundingbox (-0.25,-0.25) rectangle (3.75,2.25);
\end{tikzpicture}

```

`\pgfarrowsdeclarereversed{<start name>}{<end name>}{<old start name>}{<old end name>}`

This command creates a new arrow kind that is the “reverse” of an existing arrow kind. The (automatically created) code of the new arrow kind will contain a flip of the canvas and the meanings of the left and right extend will be reversed.

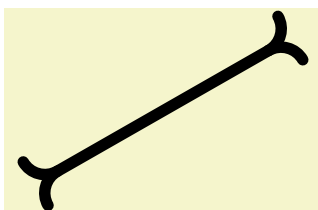

```

\pgfarrowsdeclarereversed{arcs reversed}{arcs reversed}{arcs''}{arcs''}%
\begin{tikzpicture}
  \pgfsetarrows{arcs reversed-arcs reversed}
  \pgfsetlinewidth{1ex}
  \pgfpathmoveto{\pgfpointorigin}
  \pgfpathlineto{\pgfpoint{3.5cm}{2cm}}
  \pgfusepath{stroke}
  \useasboundingbox (-0.25,-0.25) rectangle (3.75,2.25);
\end{tikzpicture}

```

`\pgfarrowsdeclarecombine*[\langle offset \rangle]{\langle start name \rangle}{\langle end name \rangle}{\langle first start name \rangle}{\langle first end name \rangle}{\langle second start name \rangle}{\langle second end name \rangle}`

This command creates a new arrow kind that combines two existing arrow kinds. The first arrow kind is the “innermost” arrow kind, the second arrow kind is the “outermost.”

The code for the combined arrow kind will install a canvas translation before the innermost arrow kind is drawn. This translation is calculated such that the right tip of the innermost arrow touches the right end of the outermost arrow. The optional `\langle offset \rangle` can be used to increase (or decrease) the distance between the inner and outermost arrow.

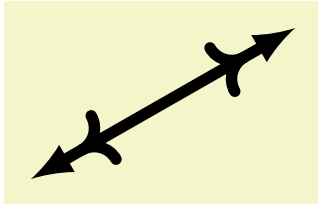

```
\pgfarrowsdeclarecombine[\pgflinewidth]
  {combined}{combined}{arcs''}{arcs''}{latex}{latex}%
\begin{tikzpicture}
  \pgfsetarrows{combined-combined}
  \pgfsetlinewidth{1ex}
  \pgfpathmoveto{\pgfpointorigin}
  \pgfpathlineto{\pgfpoint{3.5cm}{2cm}}
  \pgfusepath{stroke}
  \useasboundingbox (-0.25,-0.25) rectangle (3.75,2.25);
\end{tikzpicture}
```

In the star variant, the end of the line is not in the outermost arrow, but inside the innermost arrow.

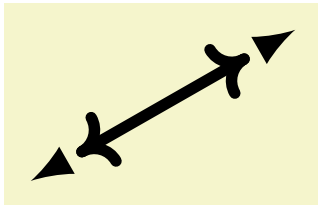

```
\pgfarrowsdeclarecombine*[\pgflinewidth]
  {combined'}{combined'}{arcs''}{arcs''}{latex}{latex}%
\begin{tikzpicture}
  \pgfsetarrows{combined'-combined'}
  \pgfsetlinewidth{1ex}
  \pgfpathmoveto{\pgfpointorigin}
  \pgfpathlineto{\pgfpoint{3.5cm}{2cm}}
  \pgfusepath{stroke}
  \useasboundingbox (-0.25,-0.25) rectangle (3.75,2.25);
\end{tikzpicture}
```

`\pgfarrowsdeclaredouble[\langle offset \rangle]{\langle start name \rangle}{\langle end name \rangle}{\langle old start name \rangle}{\langle old end name \rangle}`

This command is a shortcut for combining an arrow kind with itself.

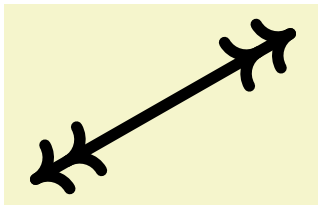

```
\pgfarrowsdeclaredouble{<<}>>{arcs''}{arcs''}%
\begin{tikzpicture}
  \pgfsetarrows{<<->>}
  \pgfsetlinewidth{1ex}
  \pgfpathmoveto{\pgfpointorigin}
  \pgfpathlineto{\pgfpoint{3.5cm}{2cm}}
  \pgfusepath{stroke}
  \useasboundingbox (-0.25,-0.25) rectangle (3.75,2.25);
\end{tikzpicture}
```

`\pgfarrowsdeclaretriple[\langle offset \rangle]{\langle start name \rangle}{\langle end name \rangle}{\langle old start name \rangle}{\langle old end name \rangle}`

This command is a shortcut for combining an arrow kind with itself and then again.

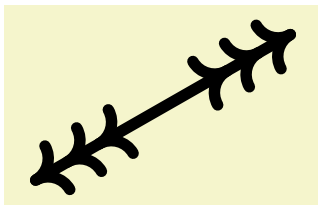

```
\pgfarrowsdeclaretriple{<<<}>>>{arcs''}{arcs''}%
\begin{tikzpicture}
  \pgfsetarrows{<<<->>>}
  \pgfsetlinewidth{1ex}
  \pgfpathmoveto{\pgfpointorigin}
  \pgfpathlineto{\pgfpoint{3.5cm}{2cm}}
  \pgfusepath{stroke}
  \useasboundingbox (-0.25,-0.25) rectangle (3.75,2.25);
\end{tikzpicture}
```

## 74.4 Using an Arrow Tip Kind

The following commands install the arrow kind that will be used when stroking is done.

`\pgfsetarrowsstart{\langle start arrow kind \rangle}`



Installs the given  $\langle start\ arrow\ kind \rangle$  for all subsequent strokes in the in the current  $\TeX$ -group. If  $\langle start\ arrow\ kind \rangle$  is empty, no arrow tips will be drawn at the start of the last segment of paths.

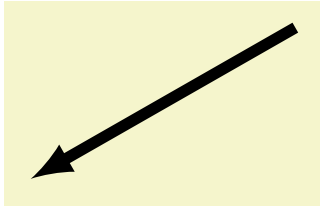

```
\begin{tikzpicture}
  \pgfsetarrowsstart{latex}
  \pgfsetlinewidth{1ex}
  \pgfpathmoveto{\pgfpointorigin}
  \pgfpathlineto{\pgfpoint{3.5cm}{2cm}}
  \pgfusepath{stroke}
  \useasboundingbox (-0.25,-0.25) rectangle (3.75,2.25);
\end{tikzpicture}
```

$\backslash\text{pgfsetarrowsend}\{\langle start\ arrow\ kind \rangle\}$

Like  $\backslash\text{pgfsetarrowsstart}$ , only for the end of the arrow.

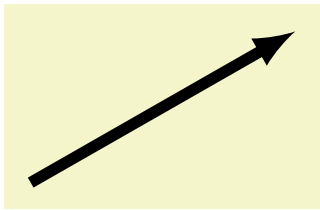

```
\begin{tikzpicture}
  \pgfsetarrowsend{latex}
  \pgfsetlinewidth{1ex}
  \pgfpathmoveto{\pgfpointorigin}
  \pgfpathlineto{\pgfpoint{3.5cm}{2cm}}
  \pgfusepath{stroke}
  \useasboundingbox (-0.25,-0.25) rectangle (3.75,2.25);
\end{tikzpicture}
```

*Warning:* If the compatibility mode is active (which is the default), there also exist old commands called  $\backslash\text{pgfsetstartarrow}$  and  $\backslash\text{pgfsetendarrow}$ , which are incompatible with the meta-arrow management.

$\backslash\text{pgfsetarrows}\{\langle start\ kind \rangle-\langle end\ kind \rangle\}$

Calls  $\backslash\text{pgfsetarrowsstart}$  for  $\langle start\ kind \rangle$  and  $\backslash\text{pgfsetarrowsend}$  for  $\langle end\ kind \rangle$ .

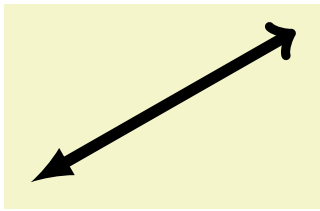

```
\begin{tikzpicture}
  \pgfsetarrows{latex-to}
  \pgfsetlinewidth{1ex}
  \pgfpathmoveto{\pgfpointorigin}
  \pgfpathlineto{\pgfpoint{3.5cm}{2cm}}
  \pgfusepath{stroke}
  \useasboundingbox (-0.25,-0.25) rectangle (3.75,2.25);
\end{tikzpicture}
```

## 74.5 Predefined Arrow Tip Kinds

The following arrow tip kinds are always defined:

|                                                |                                                                   |
|------------------------------------------------|-------------------------------------------------------------------|
| <code>stealth-stealth</code>                   | yields thick $\longleftrightarrow$ and thin $\longleftrightarrow$ |
| <code>stealth reversed-stealth reversed</code> | yields thick $\rightrightarrows$ and thin $\rightrightarrows$     |
| <code>to-to</code>                             | yields thick $\longleftrightarrow$ and thin $\longleftrightarrow$ |
| <code>to reversed-to reversed</code>           | yields thick $\rightrightarrows$ and thin $\rightrightarrows$     |
| <code>latex-latex</code>                       | yields thick $\longleftrightarrow$ and thin $\longleftrightarrow$ |
| <code>latex reversed-latex reversed</code>     | yields thick $\rightrightarrows$ and thin $\rightrightarrows$     |
| <code> -</code>                                | yields thick $\lrcorner$ and thin $\lrcorner$                     |

For further arrow tips, see page 253.

## 75 Nodes and Shapes

This section describes the `shapes` module.

```
\usepgfmodule{shapes} %  $\TeX$  and plain  $\TeX$  and pure pgf
\usepgfmodule[shapes] % Con $\TeX$ t and pure pgf
```

This module defines commands both for creating nodes and for creating shapes. The package is loaded automatically by `pgf`, but you can load it manually if you have only included `pgfcore`.

### 75.1 Overview

PGF comes with a sophisticated set of commands for creating *nodes* and *shapes*. A *node* is a graphical object that consists (typically) of (one or more) text labels and some additional stroked or filled paths. Each node has a certain *shape*, which may be something simple like a `rectangle` or a `circle`, but it may also be something complicated like a `uml class diagram` (this shape is currently not implemented, though). Different nodes that have the same shape may look quite different, however, since shapes (need not) specify whether the shape path is stroked or filled.

#### 75.1.1 Creating and Referencing Nodes

You create a node by calling the macro `\pgfnode` or the more general `\pgfmultipartnode`. These macro takes several parameters and draws the requested shape at a certain position. In addition, it will “remember” the node’s position within the current `{pgfpicture}`. You can then, later on, refer to the node’s position. Coordinate transformations are “fully supported,” which means that if you used coordinate transformations to shift or rotate the shape of a node, the node’s position will still be correctly determined by PGF. This is *not* the case if you use canvas transformations, instead.

#### 75.1.2 Anchors

An important property of a node or a shape in general are its *anchors*. Anchors are “important” positions in a shape. For example, the `center` anchor lies at the center of a shape, the `north` anchor is usually “at the top, in the middle” of a shape, the `text` anchor is the lower left corner of the shape’s text label (if present), and so on.

Anchors are important both when you create a node and when you reference it. When you create a node, you specify the node’s “position” by asking PGF to place the shape in such a way that a certain anchor lies at a certain point. For example, you might ask that the node is placed such that the `north` anchor is at the origin. This will effectively cause the node to be placed below the origin.

When you reference a node, you always reference an anchor of the node. For example, when you request the “`north` anchor of the node just placed” you will get the origin. However, you can also request the “`south` anchor of this node,” which will give you a point somewhere below the origin. When a coordinate transformation was in force at the time of creation of a node, all anchors are also transformed accordingly.

#### 75.1.3 Layers of a Shape

The simplest shape, the `coordinate`, has just one anchor, namely the `center`, and a label (which is usually empty). More complicated shapes like the `rectangle` shape also have a *background path*. This is a PGF-path that is defined by the shape. The shape does not prescribe what should happen with the path: When a node is created this path may be stroked (resulting in a frame around the label), filled (resulting in a background color for the text), or just discarded.

Although most shapes consist just of a background path plus some label text, when a shape is drawn, up to seven different layers are drawn:

1. The “behind the background layer.” Unlike the background path, which be used in different ways by different nodes, the graphic commands given for this layer will always stroke or always fill the path they construct. They might also insert some text that is “behind everything.”
2. The background path layer. How this path is used depends on how the arguments of the `\pgfnode` command.

3. The “before the background path layer.” This layer works like the first one, only the commands of this layer are executed after the background path has been used (in whatever way the creator of the node chose).
4. The label layer. This layer inserts the node’s text box(es).
5. The “behind the foreground layer.” This layer, like the first layer, once more contains graphic commands that are “simply executed.”
6. The foreground path layer. This path is treated in the same way as the background path, only it is drawn only after the label text has been drawn.
7. The “before the foreground layer.”

Which of these layers are actually used depends on the shape.

#### 75.1.4 Node Parts

A shape typically does not consist only of different background and foreground paths, but it may also have text labels. Indeed, for many shapes the text labels are the more important part of the shape.

Most shapes will have only one text label. In this case, this text label is simply passed as a parameter to the `\pgfnode` command. When the node is drawn, the text label is shifted around such that its lower left corner is at the `text` anchor of the node.

More complicated shapes may have more than one text label. Nodes of such shapes are called *multipart nodes*. The different *node parts* are simply the different text labels. For example, a `uml class` shape might have a `class name` part, a `method` part and an `attributes` part. Indeed, single part nodes are a special case of multipart nodes: They only have one part named `text`.

When a shape is declared, you must specify the node parts. There is a simple command called `\nodeparts` that takes a list of the part names as input. When you create a node of a multipart shape, for each part of the node you must have setup a `TEX`-box containing the text of the part. For a part named `XYZ` you must setup the box `\pgfnodepartXYZbox`. The box will be placed at the anchor `XYZ`. See the description of `\pgfmultipartnode` for more details.

## 75.2 Creating Nodes

You create a node using one of the following commands:

```
\pgfnode{<shape>}{<anchor>}{<label text>}{<name>}{<path usage command>}
```

This command creates a new node. The `<shape>` of the node must have been declared previously using `\pgfdeclareshape`.

The shape is shifted such that the `<anchor>` is at the origin. In order to place the shape somewhere else, use the coordinate transformation prior to calling this command.

The `<name>` is a name for later reference. If no name is given, nothing will be “saved” for the node, it will just be drawn.

The `<path usage command>` is executed for the background and the foreground path (if the shape defines them).

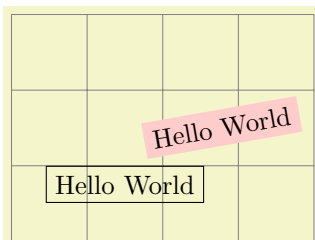

```
\begin{tikzpicture}
\draw[help lines] (0,0) grid (4,3);
{
\pgftransformshift{\pgfpoint{1.5cm}{1cm}}
\pgfnode{rectangle}{north}{Hello World}{hellonode}{\pgfusepath{stroke}}
}
{
\color{red!20}
\pgftransformrotate{10}
\pgftransformshift{\pgfpoint{3cm}{1cm}}
\pgfnode{rectangle}{center}
{\color{black}Hello World}{hellonode}{\pgfusepath{fill}}
}
\end{tikzpicture}
```

As can be seen, all coordinate transformations are also applied to the text of the shape. Sometimes, it is desirable that the transformations are applied to the point where the shape will be anchored, but you do not wish the shape itself to be transformed. In this case, you should call `\pgftransformresetnontranslations` prior to calling the `\pgfnode` command.

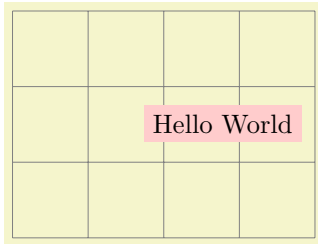

```
\begin{tikzpicture}
  \draw[help lines] (0,0) grid (4,3);
  {
    \color{red!20}
    \pgftransformrotate{10}
    \pgftransformshift{\pgfpoint{3cm}{1cm}}
    \pgftransformresetnontranslations
    \pgfnode{rectangle}{center}
      {\color{black}Hello World}{hellonode}{\pgfusepath{fill}}
  }
\end{tikzpicture}
```

The *label text* is typeset inside the  $\text{T}_\text{E}\text{X}$ -box `\pgfnodeparttextbox`. This box is shown at the `text` anchor of the node, if the node has a `text` part. See the description of `\pgfmultipartnode` for details.

**`\pgfmultipartnode`** $\langle\textit{shape}\rangle\{\langle\textit{anchor}\rangle\}\{\langle\textit{name}\rangle\}\{\langle\textit{path usage command}\rangle\}$

This command is the more general (and less user-friendly) version of the `\pgfnode` command. While the `\pgfnode` command can only be used for shapes that have a single part (which is the case for most shapes), this command can also be used with multi-part nodes.

When this command is called, for each node part of the node you must have setup one  $\text{T}_\text{E}\text{X}$ -box. Suppose the shape has two parts: The `text` part and the `lower` part. Then, prior to calling `\pgfmultipartnode`, you must have setup the boxes `\pgfnodeparttextbox` and `\pgfnodepartlowerbox`. These boxes may contain any  $\text{T}_\text{E}\text{X}$ -text. The shape code will then compute the positions of the shape's anchors based on the sizes of these shapes. Finally, when the node is drawn, the boxes are placed at the anchor positions `text` and `lower`.

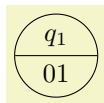

```
\setbox\pgfnodeparttextbox=\hbox{$q_1$}
\setbox\pgfnodepartlowerbox=\hbox{01}
\begin{pgfpicture}
  \pgfmultipartnode{circle split}{center}{my state}{\pgfusepath{stroke}}
\end{pgfpicture}
```

*Note:* Be careful when using the `\setbox` command inside a `{pgfpicture}` command. You will have to use `\pgfinterruptpath` at the beginning of the box and `\endpgfinterruptpath` at the end of the box to make sure that the box is typeset correctly. In the above example this problem was sidestepped by moving the box construction outside the environment.

*Note:* It is not necessary to use `\newbox` for every node part name. Although you need a different box for each part of a single shape, two different shapes may very well use the same box even when the names of the parts are different. Suppose you have a `circle split` shape that has an `lower` part and you have a `uml class` shape that has a `methods` part. Then, in order to avoid exhausting  $\text{T}_\text{E}\text{X}$ 's limited number of box registers, you can say

```
\newbox\pgfnodepartlowerbox
\let\pgfnodepartmethodsbox=\pgfnodepartlowerbox
```

Also, when you have a node part name with spaces like `class name`, it may be useful to create an alias:

```
\newbox\mybox
\expandafter\let\csname pgfnodepartclass namebox\endcsname=\mybox
```

**`\pgfcoordinate`** $\{\langle\textit{name}\rangle\}\{\langle\textit{coordinate}\rangle\}$

This command creates a node of shape `coordinate` at the given *coordinate*. Exactly the same effect can be achieved using first a shift of the coordinate system to *coordinate*, followed by creating a node of shape `coordinate` named *name*. However, this command is easier and more natural to use and, more importantly, it is much faster.

**`\pgfnodealias`** $\{\langle\textit{new name}\rangle\}\{\langle\textit{existing node}\rangle\}$

This command does not actually create a new node. Rather, it allows you to subsequently access the node *existing node* using the name *new name*.

There are a number of values that have an influence on the size of a node. These values are stored in the following keys.

`/pgf/minimum width= $\langle dimension \rangle$`  (no default, initially 1pt)  
 alias `/tikz/minimum width`

This key stores the *recommended* minimum width of a shape. Thus, when a shape is drawn and when the shape's width would be smaller than  $\langle dimension \rangle$ , the shape's width is enlarged by adding some empty space.

Note that this value is just a recommendation. A shape may choose to ignore this key.

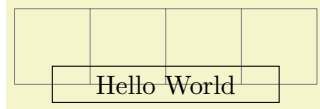

```
\begin{tikzpicture}
  \draw[help lines] (-2,0) grid (2,1);

  \pgfset{minimum width=3cm}
  \pgfnode{rectangle}{center}{Hello World}{}{\pgfusepath{stroke}}
\end{tikzpicture}
```

`/pgf/minimum height= $\langle dimension \rangle$`  (no default, initially 1pt)  
 alias `/tikz/minimum height`

Works like `/pgf/minimum width`.

`/pgf/minimum size= $\langle dimension \rangle$`  (no default)  
 alias `/tikz/minimum size`

This style both `/pgf/minimum width` and `/pgf/minimum height` to  $\langle dimension \rangle$ .

`/pgf/inner xsep= $\langle dimension \rangle$`  (no default, initially 0.3333em)  
 alias `/tikz/inner xsep`

This key stores the *recommended* horizontal inner separation between the label text and the background path. As before, this value is just a recommendation and a shape may choose to ignore this key.

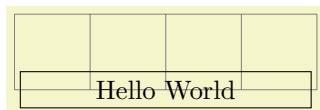

```
\begin{tikzpicture}
  \draw[help lines] (-2,0) grid (2,1);

  \pgfset{inner xsep=1cm}
  \pgfnode{rectangle}{center}{Hello World}{}{\pgfusepath{stroke}}
\end{tikzpicture}
```

`/pgf/inner ysep= $\langle dimension \rangle$`  (no default, initially 0.3333em)  
 alias `/tikz/inner ysep`

Works like `/pgf/inner xsep`.

`/pgf/inner sep= $\langle dimension \rangle$`  (no default)  
 alias `/tikz/inner sep`

This style sets both `/pgf/inner xsep` and `/pgf/inner ysep` to  $\langle dimension \rangle$ .

`/pgf/outer xsep= $\langle dimension \rangle$`  (no default, initially  $.5\pgflinewidth$ )  
 alias `/tikz/outer xsep`

This key stores the recommended horizontal separation between the background path and the “outer anchors.” For example, if  $\langle dimension \rangle$  is 1cm then the `east` anchor will be 1cm to the right of the right border of the background path. As before, this value is just a recommendation.

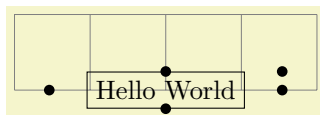

```
\begin{tikzpicture}
  \draw[help lines] (-2,0) grid (2,1);

  \pgfset{outer xsep=.5cm}
  \pgfnode{rectangle}{center}{Hello World}{x}{\pgfusepath{stroke}}

  \pgfpathcircle{\pgfpointanchor{x}{north}}{2pt}
  \pgfpathcircle{\pgfpointanchor{x}{south}}{2pt}
  \pgfpathcircle{\pgfpointanchor{x}{east}}{2pt}
  \pgfpathcircle{\pgfpointanchor{x}{west}}{2pt}
  \pgfpathcircle{\pgfpointanchor{x}{north east}}{2pt}
  \pgfusepath{fill}
\end{tikzpicture}
```

`/pgf/outer ysep=<dimension>` (no default, initially `.5\pgflinewidth`)

alias `/tikz/outer ysep`

Works like `/pgf/outer xsep`.

`/pgf/outer sep=<dimension>` (no default)

alias `/tikz/outer sep`

This style sets both `/pgf/outer xsep` and `/pgf/outer ysep` to `<dimension>`.

## 75.3 Using Anchors

Each shape defines a set of anchors. We saw already that the anchors are used when the shape is drawn: the shape is placed in such a way that the given anchor is at the origin (which in turn is typically translated somewhere else).

One has to look up the set of anchors of each shape, there is no “default” set of anchors, except for the `center` anchor, which should always be present. Also, most shapes will declare anchors like `north` or `east`, but this is not guaranteed.

### 75.3.1 Referencing Anchors of Nodes in the Same Picture

Once a node has been defined, you can refer to its anchors using the following commands:

`\pgfpointanchor{<node>}{<anchor>}`

This command is another “point command” like the commands described in Section 70. It returns the coordinate of the given `<anchor>` in the given `<node>`. The command can be used in commands like `\pgfpathmoveto`.



```
\begin{pgfpicture}
  \pgftransformrotate{30}
  \pgfnode{rectangle}{center}{Hello World!}{x}{\pgfusepath{stroke}}

  \pgfpathcircle{\pgfpointanchor{x}{north}}{2pt}
  \pgfpathcircle{\pgfpointanchor{x}{south}}{2pt}
  \pgfpathcircle{\pgfpointanchor{x}{east}}{2pt}
  \pgfpathcircle{\pgfpointanchor{x}{west}}{2pt}
  \pgfpathcircle{\pgfpointanchor{x}{north east}}{2pt}
  \pgfusepath{fill}
\end{pgfpicture}
```

In the above example, you may have noticed something curious: The rotation transformation is still in force when the anchors are invoked, but it does not seem to have an effect. You might expect that the rotation should apply to the already rotated points once more.

However, `\pgfpointanchor` returns a point that takes the current transformation matrix into account: *The inverse transformation to the current coordinate transformation is applied to an anchor point before returning it.*

This behavior may seem a bit strange, but you will find it very natural in most cases. If you really want to apply a transformation to an anchor point (for example, to “shift it away” a little bit), you have to invoke `\pgfpointanchor` without any transformations in force. Here is an example:



```
\begin{pgfpicture}
  \pgftransformrotate{30}
  \pgfnode{rectangle}{center}{Hello World!}{x}{\pgfusepath{stroke}}

  {
    \pgftransformreset
    \pgfpointanchor{x}{east}
    \xdef\mycoordinate{\noexpand\pgfpoint{\the\pgf@x}{\the\pgf@y}}
  }

  \pgfpathcircle{\mycoordinate}{2pt}
  \pgfusepath{fill}
\end{pgfpicture}
```

A special situation arises when the `<node>` lies in a picture different from the current picture. In this case, if you have not told PGF that the picture should be “remembered,” the `<node>` will be treated as if

it lied in the current picture. For example, if the  $\langle node \rangle$  was at position (3, 2) in the original picture, it is treated as if it lied at position (3, 2) in the current picture. However, if you have told PGF to remember the picture position of the node's picture and also of the current picture, then `\pgfpointanchor` will return a coordinate that corresponds to the position of the node's anchor on the page, transformed into the current coordinate system. For examples and more details see Section 75.3.2.

**`\pgfpointshapeborder`** $\{\langle node \rangle\}\{\langle point \rangle\}$

This command returns the point on the border of the shape that lies on a straight line from the center of the node to  $\langle point \rangle$ . For complex shapes it is not guaranteed that this point will actually lie on the border, it may be on the border of a “simplified” version of the shape.



```
\begin{pgfpicture}
\begin{pgfscope}
\pgftransformrotate{30}
\pgfnode{rectangle}{center}{Hello World!}{x}{\pgfusepath{stroke}}
\end{pgfscope}
\pgfpathcircle{\pgfpointshapeborder{x}{\pgfpoint{2cm}{1cm}}}{2pt}
\pgfpathcircle{\pgfpoint{2cm}{1cm}}{2pt}
\pgfpathcircle{\pgfpointshapeborder{x}{\pgfpoint{-1cm}{1cm}}}{2pt}
\pgfpathcircle{\pgfpoint{-1cm}{1cm}}{2pt}
\pgfusepath{fill}
\end{pgfpicture}
```

### 75.3.2 Referencing Anchors of Nodes in Different Pictures

As a picture is typeset, PGF keeps track of the positions of all nodes inside the picture. What PGF does not remember is the position of the picture *itself* on the page. Thus, if you define a node in one picture and then try to reference this node while another picture is typeset, PGF will only know the position of the nodes that you try to typeset inside the original picture, but it will not know where this picture lies. What is missing is the relative positioning of the two pictures.

To overcome this problem, you need to tell PGF that it should remember the position of pictures on a page. If these positions are remembered, then PGF can compute the offset between the pictures and make nodes in different pictures accessible.

Determining the positions of pictures on the page is, alas, not-so-easy. Because of this, PGF does not do so automatically. Rather, you have to proceed as follows:

1. You have to use a backend driver that supports position tracking. `pdfTeX` is one such drivers, `dvips` currently is not.
2. You have to say `\pgfrememberpicturepositiononpagetrue` somewhere before or inside every picture
  - in which you wish to reference a node and
  - from which you wish to reference a node in another picture.

The second item is important since PGF does not only need to know the position of the picture in which the node you wish to reference lies, but it also needs to know where the current picture lies.

3. You typically have to run `TeX` twice (depending on the backend driver) since the position information typically gets written into an external file on the first run and is available only on the second run.
4. You have to switch off automatic bounding box computations. The reason is that the node in the other picture should not influence the size of the bounding box of the current picture. You should say `\pgfusepath{use as bounding box}` before using a coordinate in another picture.

## 75.4 Special Nodes

There are several special nodes that are always defined and which you should not attempt to redefine.

Predefined node **`current bounding box`**

This node is of shape `rectangle`. Unlike normal nodes, its size changes constantly and always reflects the size of the bounding box of the current picture. This means that, for instance, that

```
\pgfpointanchor{current bounding box}{south east}
```

returns the lower left corner of the bounding box of the current picture.



### Predefined node `current path bounding box`

This node is also of shape `rectangle`. Its size is the size of the bounding box of the current path.

### Predefined node `current page`

This node is inside a virtual remembered picture. The size of this node is the size of the current page. This means that if you create a remembered picture and inside this picture you reference an anchor of this node, you reference an absolute position on the page. To demonstrate the effect, the following code puts some text in the lower left corner of the current page. Note that this works only if the backend driver supports it, otherwise the text is inserted right here.

```
\pgfrememberpicturepositiononpagetrue
\begin{pgfpicture}
  \pgfusepath{use as bounding box}
  \pgftransformshift{\pgfpointanchor{current page}{south west}}
  \pgftransformshift{\pgfpoint{1cm}{1cm}}
  \pgftext[left,base]{
    \textcolor{red}{
      Text absolutely positioned in
      the lower left corner.}
  }
\end{pgfpicture}
```

There is also an option that allows you to create new special nodes quite similar to the above:

`/pgf/local bounding box=<node name>` (no default)

alias `/tikz/local bounding box`

This defines a new node `<node name>` whose size is the bounding box around all objects in the current scope starting at the position where this option was given. After the end of the scope, the `<node name>` is still available. You can use this option to keep track of the size of a certain area. Note that excessive use of this option (keeping track of dozens of bounding boxes at the same time) will slow things down.

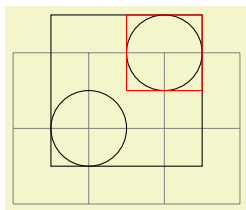

```
\begin{tikzpicture}
  \draw [help lines] (0,0) grid (3,2);
  { [local bounding box=outer box]
    \draw (1,1) circle (.5) [local bounding box=inner box] (2,2) circle (.5);
  }
  \draw (outer box.south west) rectangle (outer box.north east);
  \draw[red] (inner box.south west) rectangle (inner box.north east);
\end{tikzpicture}
```

## 75.5 Declaring New Shapes

There are only three predefined shapes, see Section 46.2, so there must be some way of defining new shapes. Defining a shape is, unfortunately, a not-quite-trivial process. The reason is that shapes need to be both very flexible (their size will vary greatly according to circumstances) and they need to be constructed reasonably “fast.” PGF must be able to handle pictures with several hundreds of nodes and documents with thousands of nodes in total. It would not do if PGF had to compute and store, say, dozens of anchor positions for every node.

### 75.5.1 What Must Be Defined For a Shape?

In order to define a new shape, you must provide:

- a *shape name*,
- code for computing the *saved anchors* and *saved dimensions*,
- code for computing *anchor* positions in terms of the saved anchors,
- optionally code for the *background path* and *foreground path*,
- optionally code for *things to be drawn before or behind* the background and foreground paths.
- optionally a list of node parts.



### 75.5.2 Normal Anchors Versus Saved Anchors

Anchors are special places in shape. For example, the `north east` anchor, which is a normal anchor, lies at the upper right corner of the `rectangle` shape, as does `\northeast`, which is a saved anchor. The difference is the following: *saved anchors are computed and stored for each node, anchors are only computed as needed.* The user only has access to the normal anchors, but a normal anchor can just “copy” or “pass through” the location of a saved anchor.

The idea behind all this is that a shape can declare a very large number of normal anchors, but when a node of this shape is created, these anchors are not actually computed. However, this causes a problem: When we wish to reference an anchor of a node at some later time, we must still be able to compute the position of the anchor. For this, we may need a lot of information: What was the transformation matrix that was in force when the node was created? What was the size of the text box? What were the values of the different separation dimensions? And so on.

To solve this problem, PGF will always compute the locations of all *saved anchors* and store these positions. Then, when a normal anchor position is requested later on, the anchor position can be given just from knowing where the locations of the saved anchors.

As an example, consider the `rectangle` shape. For this shape two anchors are saved: The `\northeast` corner and the `\southwest` corner. A normal anchor like `north west` can now easily be expressed in terms of these coordinates: Take the  $x$ -position of the `\southwest` point and the  $y$ -position of the `\northeast` point. The `rectangle` shape currently defines 13 normal anchors, but needs only two saved anchors. Adding new anchors like a `south south east` anchor would not increase the memory and computation requirements of pictures.

All anchors (both saved and normal) are specified in a local *shape coordinate space*. This is also true for the background and foreground paths. The `\pgfnode` macro will automatically apply appropriate transformations to the coordinates so that the shape is shifted to the right anchor or otherwise transformed.

### 75.5.3 Command for Declaring New Shapes

The following command declares a new shape:

```
\pgfdeclareshape{<shape name>}{<shape specification>}
```

This command declares a new shape named *<shape name>*. The shape name can later be used in commands like `\pgfnode`.

The *<shape specification>* is some T<sub>E</sub>X code containing calls to special commands that are only defined inside the *<shape specification>* (similarly to commands like `\draw` that are only available inside the `{tikzpicture}` environment).

*Example:* Here is the code of the `coordinate` shape:

```
\pgfdeclareshape{coordinate}
{
  \savedanchor\centerpoint{%
    \pgf@x=.5\wd\pgfnodeparttextbox%
    \pgf@y=.5\ht\pgfnodeparttextbox%
    \advance\pgf@y by -.5\dp\pgfnodeparttextbox%
  }
  \anchor{center}{\centerpoint}
  \anchorborder{\centerpoint}
}
```

The special commands are explained next. In the examples given for the special commands a new shape will be constructed, which we might call `simple rectangle`. It should behave like the normal rectangle shape, only without bothering about the fine details like inner and outer separations. The skeleton for the shape is the following.

```
\pgfdeclareshape{simple rectangle}{
  ...
}
```

```
\nodeparts{<list of node parts>}
```

This command declares which parts make up nodes of this shape. A *node part* is a (possibly empty) text label that is drawn when a node of the shape is created.

By default, a shape has just one node part called `text`. However, there can be several node parts. For example, the `circle split` shape has two parts: the `text` part, which shows that upper text, and a `lower` part, which shows the lower text. For the `circle split` shape the `\nodeparts` command was called with the argument `{text,lower}`.

When a multipart node is created, the text labels are drawn in the sequences listed in the *list of node parts*. For each node part there you must have declared one anchor and the T<sub>E</sub>X-box of the part is placed at this anchor. For a node part called `XYZ` the T<sub>E</sub>X-box `\pgfnodepartXYZbox` is placed at anchor `XYZ`.

`\savedanchor{<command>}{<code>}`

This command declares a saved anchor. The argument `<command>` should be a T<sub>E</sub>X macro name like `\centerpoint`.

The `<code>` will be executed each time `\pgfnode` (or `\pgfmultipartnode`) is called to create a node of the shape `<shape name>`. When the `<code>` is executed, the T<sub>E</sub>X-boxes of the node parts will contain the text labels of the node. Possibly, these boxes are void. For example, if there is just a `text` part, the node `\pgfnodeparttextbox` will be setup when the `<code>` is executed.

The `<code>` can use the width, height, and depth of the box(es) to compute the location of the saved anchor. In addition, the `<code>` can take into account the values of dimensions like `\pgfshapeminwidth` or `\pgfshapeinnerxsep`. Furthermore, the `<code>` can take into consideration the values of any further shape-specific variables that are set at the moment when `\pgfnode` is called.

The net effect of the `<code>` should be to set the two T<sub>E</sub>X dimensions `\pgf@x` and `\pgf@y`. One way to achieve this is to say `\pgfpoint{<x value>}{<y value>}` at the end of the `<code>`, but you can also just set these variables. The values that `\pgf@x` and `\pgf@y` have after the code has been executed, let us call them `x` and `y`, will be recorded and stored together with the node that is created by the command `\pgfnode`.

The macro `<command>` is defined to be `\pgfpoint{x}{y}`. However, the `<command>` is only locally defined while anchor positions are being computed. Thus, it is possible to use very simple names for `<command>`, like `\center` or `\a`, without causing a name-clash. (To be precise, very simple `<command>` names will clash with existing names, but only locally inside the computation of anchor positions; and we do not need the normal `\center` command during these computations.)

For our `simple rectangle` shape, we will need only one saved anchor: The upper right corner. The lower left corner could either be the origin or the “mirrored” upper right corner, depending on whether we want the text label to have its lower left corner at the origin or whether the text label should be centered on the origin. Either will be fine, for the final shape this will make no difference since the shape will be shifted anyway. So, let us assume that the text label is centered on the origin (this will be specified later on using the `text` anchor). We get the following code for the upper right corner:

```
\savedanchor{\upperrightcorner}{
  \pgf@y=.5\ht\pgfnodeparttextbox % height of the box, ignoring the depth
  \pgf@x=.5\wd\pgfnodeparttextbox % width of the box
}
```

If we wanted to take, say, the `\pgfshapeminwidth` into account, we could use the following code:

```
\savedanchor{\upperrightcorner}{
  \pgf@y=.5\ht\pgfnodeparttextbox % height of the box
  \pgf@x=.5\wd\pgfnodeparttextbox % width of the box
  \setlength{\pgf@xa}{\pgfshapeminwidth}
  \ifdim\pgf@x<.5\pgf@xa
    \pgf@x=.5\pgf@xa
  \fi
}
```

Note that we could not have written `.5\pgfshapeminwidth` since the minimum width is stored in a “plain text macro,” not as a real dimension. So if `\pgfshapeminwidth` depth were 2cm, writing `.5\pgfshapeminwidth` would yield the same as `.52cm`.

In the “real” `rectangle` shape the code is somewhat more complex, but you get the basic idea.

`\saveddimen{<command>}{<code>}`

This command is similar to `\savedanchor`, only instead of setting  $\langle command \rangle$  to `\pgfpoint{x}{y}`, the  $\langle command \rangle$  is set just to (the value of)  $x$ .

In the `simple rectangle` shape we might use a saved dimension to store the depth of the shape box.

```
\saveddimen{\depth}{
  \pgf@x=\dp\pgfnodeparttextbox
}
```

`\savedmacro` $\langle command \rangle$  $\langle code \rangle$

This command is similar to `\saveddimen`, only at some point in  $\langle code \rangle$ ,  $\langle command \rangle$  should be defined appropriately, (this could be a value, or some text).

In the `regular polygon` shape, a saved macro is used to store the number of sides of the polygon.

```
\savedmacro{\sides}{\let\sides\pgfpolygon\sides}
```

`\anchor` $\langle name \rangle$  $\langle code \rangle$

This command declares an anchor named  $\langle name \rangle$ . Unlike for saved anchors, the  $\langle code \rangle$  will not be executed each time a node is declared. Rather, the  $\langle code \rangle$  is only executed when the anchor is specifically requested; either for anchoring the node during its creation or as a position in the shape referenced later on.

The  $\langle name \rangle$  is a quite arbitrary string that is not “passed down” to the system level. Thus, names like `south` or `1` or `::` would all be fine.

A saved anchor is not automatically also a normal anchor. If you wish to give the users access to a saved anchor you must declare a normal anchor that just returns the position of the saved anchor.

When the  $\langle code \rangle$  is executed, all saved anchor macros will be defined. Thus, you can reference them in your  $\langle code \rangle$ . The effect of the  $\langle code \rangle$  should be to set the values of `\pgf@x` and `\pgf@y` to the coordinates of the anchor.

Let us consider some example for the `simple rectangle` shape. First, we would like to make the upper right corner publicly available, for example as `north east`:

```
\anchor{north east}{\upperrightcorner}
```

The `\upperrightcorner` macro will set `\pgf@x` and `\pgf@y` to the coordinates of the upper right corner. Thus, `\pgf@x` and `\pgf@y` will have exactly the right values at the end of the anchor’s code. Next, let us define a `north west` anchor. For this anchor, we can negate the `\pgf@x` variable:

```
\anchor{north west}{
  \upperrightcorner
  \pgf@x=-\pgf@x
}
```

Finally, it is a good idea to always define a `center` anchor, which will be the default location for a shape.

```
\anchor{center}{\pgfpointorigin}
```

You might wonder whether we should not take into consideration that the node is not placed at the origin, but has been shifted somewhere. However, the anchor positions are always specified in the shape’s “private” coordinate system. The “outer” transformation that has been applied to the shape upon its creation is applied automatically to the coordinates returned by the anchor’s  $\langle code \rangle$ .

Out `simple rectangle` only has one text label (node part) called `text`. This is the default situation, so we need not do anything. For the `text` node part we must setup a `text` anchor. This anchor is used upon creation of a node to determine the lower left corner of the text label (within the private coordinate system of the shape). By default, the `text` anchor is at the origin, but you may change this. For example, we would say

```

\anchor{text}{%
  \upperrightcorner%
  \pgf@x=-\pgf@x%
  \pgf@y=-\pgf@y%
}

```

to center the text label on the origin in the shape coordinate space. Note that we could *not* have written the following:

```

\anchor{text}{\pgfpoint{-.5\wd\pgfnodeparttextbox}{-.5\ht\pgfnodeparttextbox}}

```

Do you see why this is wrong? The problem is that the box `\pgfnodeparttextbox` will most likely not have the correct size when the anchor is computed. After all, the anchor position might be recomputed at a time when several other nodes have been created.

If a shape has several node parts, we would have to define an anchor for each part.

### `\anchorborder{<code>}`

A *border anchor* is an anchor point on the border of the shape. What exactly is considered as the “border” of the shape depends on the shape.

When the user request a point on the border of the shape using the `\pgfpointshapeborder` command, the `<code>` will be executed to discern this point. When the execution of the `<code>` starts, the dimensions `\pgf@x` and `\pgf@y` will have been set to a location  $p$  in the shape’s coordinate system. It is now the job of the `<code>` to setup `\pgf@x` and `\pgf@y` such that they specify the point on the shape’s border that lies on a straight line from the shape’s center to the point  $p$ . Usually, this is a somewhat complicated computation, involving many case distinctions and some basic math.

For our `simple rectangle` we must compute a point on the border of a rectangle whose one corner is the origin (ignoring the depth for simplicity) and whose other corner is `\upperrightcorner`. The following code might be used:

```

\anchorborder{%
  % Call a function that computes a border point. Since this
  % function will modify dimensions like \pgf@x, we must move them to
  % other dimensions.
  \@tempdima=\pgf@x
  \@tempdimb=\pgf@y
  \pgfpointborderrectangle{\pgfpoint{\@tempdima}{\@tempdimb}}{\upperrightcorner}
}

```

### `\backgroundpath{<code>}`

This command specifies the path that “makes up” the background of the shape. Note that the shape cannot prescribe what is going to happen with the path: It might be drawn, shaded, filled, or even thrown away. If you want to specify that something should “always” happen when this shape is drawn (for example, if the shape is a stop-sign, we *always* want it to be filled with a red color), you can use commands like `\beforebackgroundpath`, explained below.

When the `<code>` is executed, all saved anchors will be in effect. The `<code>` should contain path construction commands.

For our `simple rectangle`, the following code might be used:

```

\backgroundpath{
  \pgfpathrectanglecorners
    {\upperrightcorner}
    {\pgfpointscale{-1}{\upperrightcorner}}
}

```

As the name suggests, the background path is used “behind” the text labels. Thus, this path is used first, then the text labels are drawn, possibly obscuring part of the path.

### `\foregroundpath{<code>}`

This command works like `\backgroundpath`, only it is invoked after the text labels have been drawn. This means that this path can possibly obscure (part of) the text labels.

`\behindbackgroundpath{<code>}`

Unlike the previous two commands, `<code>` should not only construct a path, it should also use this path in whatever way is appropriate. For example, the `<code>` might fill some area with a uniform color.

Whatever the `<code>` does, it does it first. This means that any drawing done by `<code>` will be even behind the background path.

Note that the `<code>` is protected with a `{pgfscope}`.

`\beforebackgroundpath{<code>}`

This command works like `\behindbackgroundpath`, only the `<code>` is executed after the background path has been used, but before the text labels are drawn.

`\behindforegroundpath{<code>}`

The `<code>` is executed after the text labels have been drawn, but before the foreground path is used.

`\beforeforegroundpath{<code>}`

This `<code>` is executed at the very end.

`\inheritsavedanchors[from={<another shape name>}]`

This command allows you to inherit the code for saved anchors from `<another shape name>`. The idea is that if you wish to create a new shape that is just a small modification of a another shape, you can recycle the code used for `<another shape name>`.

The effect of this command is the same as if you had called `\savedanchor` and `\saveddimen` for each saved anchor or saved dimension declared in `<another shape name>`. Thus, it is not possible to “selectively” inherit only some saved anchors, you always have to inherit all saved anchors from another shape. However, you can inherit the saved anchors of more than one shape by calling this command several times.

`\inheritbehindbackgroundpath[from={<another shape name>}]`

This command can be used to inherit the code used for the drawings behind the background path from `<another shape name>`.

`\inheritbackgroundpath[from={<another shape name>}]`

Inherits the background path code from `<another shape name>`.

`\inheritbeforebackgroundpath[from={<another shape name>}]`

Inherits the before background path code from `<another shape name>`.

`\inheritbehindforegroundpath[from={<another shape name>}]`

Inherits the behind foreground path code from `<another shape name>`.

`\inheritforegroundpath[from={<another shape name>}]`

Inherits the foreground path code from `<another shape name>`.

`\inheritbeforeforegroundpath[from={<another shape name>}]`

Inherits the before foreground path code from `<another shape name>`.

`\inheritanchor[from={<another shape name>}]<name>`

Inherits the code of one specific anchor named `<name>` from `<another shape name>`. Thus, unlike saved anchors, which must be inherited collectively, normal anchors can and must be inherited individually.

`\inheritanchorborder[from={<another shape name>}]`

Inherits the border anchor code from `<another shape name>`.

The following example shows how a shape can be defined that relies heavily on inheritance:

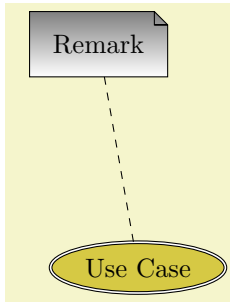

```

\pgfdeclareshape{document}{
  \inheritsavedanchors[from=rectangle] % this is nearly a rectangle
  \inheritanchorborder[from=rectangle]
  \inheritanchor[from=rectangle]{center}
  \inheritanchor[from=rectangle]{north}
  \inheritanchor[from=rectangle]{south}
  \inheritanchor[from=rectangle]{west}
  \inheritanchor[from=rectangle]{east}
  % ... and possibly more
  \backgroundpath{% this is new
    % store lower right in xa/ya and upper right in xb/yb
    \southwest \pgf@xa=\pgf@x \pgf@ya=\pgf@y
    \northeast \pgf@xb=\pgf@x \pgf@yb=\pgf@y
    % compute corner of 'flipped page'
    \pgf@xc=\pgf@xb \advance\pgf@xc by-5pt % this should be a parameter
    \pgf@yc=\pgf@yb \advance\pgf@yc by-5pt
    % construct main path
    \pgfpathmoveto{\pgfpoint{\pgf@xa}{\pgf@ya}}
    \pgfpathlineto{\pgfpoint{\pgf@xa}{\pgf@yb}}
    \pgfpathlineto{\pgfpoint{\pgf@xc}{\pgf@yb}}
    \pgfpathlineto{\pgfpoint{\pgf@xb}{\pgf@yc}}
    \pgfpathlineto{\pgfpoint{\pgf@xb}{\pgf@ya}}
    \pgfpathclose
    % add little corner
    \pgfpathmoveto{\pgfpoint{\pgf@xc}{\pgf@yb}}
    \pgfpathlineto{\pgfpoint{\pgf@xc}{\pgf@yc}}
    \pgfpathlineto{\pgfpoint{\pgf@xb}{\pgf@yc}}
    \pgfpathlineto{\pgfpoint{\pgf@xc}{\pgf@yc}}
  }
}\hskip-1.2cm
\begin{tikzpicture}
  \node[shade,draw,shape=document,inner sep=2ex] (x) {Remark};
  \node[fill=examplefill,draw,ellipse,double]
    at ([shift=(-80:3cm)]x) (y) {Use Case};

  \draw[dashed] (x) -- (y);
\end{tikzpicture}

```

## 76 Matrices

```
\usepgfmodule{matrix} %  $\TeX$  and plain  $\TeX$  and pure pgf
\usepgfmodule[matrix] % Con $\TeX$ t and pure pgf
```

The present section documents the commands of this module.

### 76.1 Overview

Matrices are a mechanism for aligning several so-called cell pictures horizontally and vertically. The resulting alignment is placed in a normal node and the command for creating matrices, `\pgfmatrix`, takes options very similar to the `\pgfnode` command.

In the following, the basic idea behind the alignment mechanism is explained first. Then the command `\pgfmatrix` is explained. At the end of the section additional ways of modifying the width of columns and rows is discussed.

### 76.2 Cell Pictures and Their Alignment

A matrix consists of rows of *cells*. Cells are separated using the special command `\pgfmatrixnextcell`, rows are ended using the command `\pgfmatrixendrow` (the command `\` is setup to mean the same as `\pgfmatrixendrow` by default). Each cell contains a *cell picture*, although cell pictures are not complete pictures as they lack layers. However, each cell picture has its own bounding box like a normal picture does. These bounding boxes are important for the alignment as explained in the following.

Each cell picture will have an origin somewhere in the picture (or even outside the picture). The position of these origins is important for the alignment: On each row the origins will be on the same horizontal line and for each column the origins will also be on the same vertical line. These two requirements mean that the cell pictures may need to be shifted around so that the origins wind up on the same lines. The top of a row is given by the top of the cell picture whose bounding box's maximum  $y$ -position is largest. Similarly, the bottom of a row is given by the bottom of the cell picture whose bounding box's minimum  $y$ -position is the most negative. Similarly, the left end of a row is given by the left end of the cell whose bounding box's  $x$ -position is the most negative; and similarly for the right end of a row.

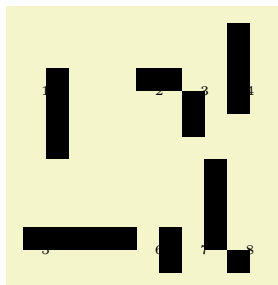

```
\begin{tikzpicture}[x=3mm,y=3mm,fill=blue!50]
  \def\atorig#1{\node[black] at (0,0) {\tiny #1};}

  \pgfmatrix{rectangle}{center}{mymatrix}
  {\pgfusepath{}}{\pgfpointorigin}{}
  {
    \fill (0,-3) rectangle (1,1);\atorig1 \pgfmatrixnextcell
    \fill (-1,0) rectangle (1,1);\atorig2 \pgfmatrixnextcell
    \fill (-1,-2) rectangle (0,0);\atorig3 \pgfmatrixnextcell
    \fill (-1,-1) rectangle (0,3);\atorig4 \
    \fill (-1,0) rectangle (4,1);\atorig5 \pgfmatrixnextcell
    \fill (0,-1) rectangle (1,1);\atorig6 \pgfmatrixnextcell
    \fill (0,0) rectangle (1,4);\atorig7 \pgfmatrixnextcell
    \fill (-1,-1) rectangle (0,0);\atorig8 \
  }
\end{tikzpicture}
```

### 76.3 The Matrix Command

All matrices are typeset using the following command:

```
\pgfmatrix{ $\langle shape \rangle$ }{ $\langle anchor \rangle$ }{ $\langle name \rangle$ }{ $\langle usage \rangle$ }{ $\langle shift \rangle$ }{ $\langle pre-code \rangle$ }{ $\langle matrix cells \rangle$ }
```

This command creates a node that contains a matrix. The name of the node is  $\langle name \rangle$ , its shape is  $\langle shape \rangle$  and the node is anchored at  $\langle anchor \rangle$ .

The  $\langle matrix cell \rangle$  parameter contains the cells of the matrix. In each cell drawing commands may be given, which create a so-called cell picture. For each cell picture a bounding box is computed and the cells are aligned according to the rules outlined in the previous section.

The resulting matrix is used as the `text` box of the node. As for a normal node, the  $\langle usage \rangle$  commands are applied, so that the path(s) of the resulting node are stroked or filled or whatever.



**Specifying the cells and rows.** Even though this command uses `\halign` internally, there are two special rules for indicating cells:

1. Cells in the same row must be separated using the macro `\pgfmatrixnextcell` rather than `&`. Using `&` will result in an error message.  
However, you can make `&` an active character and have it expand to `\pgfmatrixnextcell`. This way, it will “look” as if `&` is used.
2. Rows are ended using the command `\pgfmatrixendrow`, but `\\` is setup to mean the same by default. However, some environments like `{minipage}` redefine `\\`, so it is good to have `\pgfmatrixendrow` as a “fallback.”
3. Every row *including the last row* must be ended using the command `\\` or `\pgfmatrixendrow`.

Both `\pgfmatrixnextcell` and `\pgfmatrixendrow` (and, thus, also `\\`) take an optional argument as explained in the Section 76.4

|                    |                                                                                                                                                                                                                                                                     |
|--------------------|---------------------------------------------------------------------------------------------------------------------------------------------------------------------------------------------------------------------------------------------------------------------|
| <pre>a b c d</pre> | <pre>\begin{tikzpicture}   \pgfmatrix{rectangle}{center}{mymatrix}   {\pgfusepath{}}{\pgfpointorigin}{}   {     \node {a}; \pgfmatrixnextcell \node {b}; \pgfmatrixendrow     \node {c}; \pgfmatrixnextcell \node {d}; \pgfmatrixendrow   } \end{tikzpicture}</pre> |
|--------------------|---------------------------------------------------------------------------------------------------------------------------------------------------------------------------------------------------------------------------------------------------------------------|

**Anchoring matrices at nodes inside the matrix.** The parameter `<shift>` is an additional negative shift for the node. Normally, such a shift could be given beforehand (that is, the shift could be preapplied to the current transformation matrix). However, when `<shift>` is evaluated, you can refer to *temporary* positions of nodes inside the matrix. In detail, the following happens: When the matrix has been typeset, all nodes in the matrix temporarily get assigned their positions in the matrix box. The origin of this coordinate system is at the left baseline end of the matrix box, which corresponds to the `text` anchor. The position `<shift>` is then interpreted inside this coordinate system and then used for shifting. This allows you to use the parameter `<shift>` in the following way: If you use `text` as the `<anchor>` and specify `\pgfpointanchor{inner node}{some anchor}` for the parameter `<shift>`, where `inner node` is a node that is created in the matrix, then the whole matrix will be shifted such that `inner node.some anchor` lies at the origin of the whole picture.

**Rotations and scaling.** The matrix node is never rotated or shifted, because the current coordinate transformation matrix is reset (except for the translational part) at the beginning of `\pgfmatrix`. This is intentional and will not change in the future. If you need to rotate the matrix, you must install an appropriate canvas transformation yourself.

However, nodes and stuff inside the cell pictures can be rotated and scaled normally.

**Callbacks.** At the beginning and at the end of each cell the special macros `\pgfmatrixbegincode`, `\pgfmatrixendcode` and possibly `\pgfmatrixemptycode` are called. The effect is explained in Section 76.5.

**Executing extra code.** The parameter `<pre-code>` is executed at the beginning of the outermost `TEX`-group enclosing the matrix node. It is inside this `TEX`-group, but outside the matrix itself. It can be used for different purposes:

1. It can be used to simplify the next cell macro. For example, saying `\let\&=\pgfmatrixnextcell` allows you to use `&` instead of `\pgfmatrixnextcell`. You can also set the catcode of `&` to active.
2. It can be used to issue an `\aftergroup` command. This allows you to regain control after the `\pgfmatrix` command. (If you do not know the `\aftergroup` command, you are probably blessed with a simple and happy life.)

**Special considerations concerning macro expansion.** As said before, the matrix is typeset using `\halign` internally. This command does a lot of strange and magic things like expanding the first macro of every cell in a most unusual manner. Here are some effects you may wish to be aware of:



- It is not necessary to actually mention `\pgfmatrixnextcell` or `\pgfmatrixendrow` inside the  $\langle matrix cells \rangle$ . It suffices that the macros inside  $\langle matrix cells \rangle$  expand to these macros sooner or later.
- In particular, you can define clever macros that insert columns and rows as needed for special effects.

## 76.4 Row and Column Spacing

It is possible to control the space between columns and rows rather detailedly. Two commands are important for the row spacing and two commands for the column spacing.

`\pgfsetmatrixcolumnsep` $\langle sep list \rangle$

This macro sets the default separation list for columns. The details of the format of this list are explained in the description of the next command.

`\pgfmatrixnextcell` $[\langle additional sep list \rangle]$

This command has two purposes: First, it is used to separate cells. Second, by providing the optional argument  $\langle additional sep list \rangle$  you can modify the spacing between the columns that are separated by this command.

The optional  $\langle additional sep list \rangle$  may only be provided when the `\pgfmatrixnextcell` command starts a new column. Normally, this will only be the case in the first row, but sometimes a later row has more elements than the first row. In this case, the `\pgfmatrixnextcell` commands that start the new columns in the later row may also have the optional argument. Once a column has been started, subsequent uses of this optional argument for the column have no effect.

To determine the space between the two columns they are separated by `\pgfmatrixnextcell`, the following algorithm is executed:

1. Both the default separation list (as setup by `\pgfsetmatrixcolumnsep`) and the  $\langle additional sep list \rangle$  are processed, in this order. If the  $\langle additional sep list \rangle$  argument is missing, only the default separation list is processed.
2. Both lists may contain dimensions, separated by commas, as well as occurrences of the keywords `between origins` and `between borders`.
3. All dimensions occurring in either list are added together to arrive at a dimension  $d$ .
4. The last occurrence of either of the keywords is located. If neither keyword is present, we proceed as if `between borders` were present.

At the end of the algorithm, a dimension  $d$  has been computed and one of the two *modes* `between borders` and `between origins` has been determined. Depending on which mode has been determined, the following happens:

- For the `between borders` mode, an additional horizontal space of  $d$  is added between the two columns. Note that  $d$  may be negative.
- For the `between origins` mode, the spacing between the two columns is computed differently: Recall that the origins of the cell pictures in both pictures lie on two vertical lines. The spacing between the two columns is setup such that the horizontal distance between these two lines is exactly  $d$ .

This mode may only be used between columns *already introduced in the first row*.

All of the above rules boil down to the following effects:

- A default spacing between columns should be setup using `\pgfsetmatrixcolumnsep`. For example, you might say `\pgfsetmatrixcolumnsep{5pt}` to have columns be spaced apart by 5pt. You could say

```
\pgfsetmatrixcolumnsep{1cm,between origins}
```

to specify that horizontal space between the origins of cell pictures in adjacent columns should be 1cm by default – regardless of the actual size of the cell pictures.

- You can now use the optional argument of `\pgfmatrixnextcell` to locally overrule the spacing between two columns. By saying `\pgfmatrixnextcell[5pt]` you *add* 5pt to the space between of the two columns, regardless of the mode.

You can also (locally) change the spacing mode for these two columns. For example, even if the normal spacing mode is `between origins`, you can say

```
\pgfmatrixnextcell[5pt,between borders]
```

to locally change the mode for these columns to `between borders`.

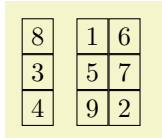

```
\begin{tikzpicture}[every node/.style=draw]
  \pgfsetmatrixcolumnsep{1mm}
  \pgfmatrix{rectangle}{center}{mymatrix}
  {\pgfusepath{}}{\pgfpointorigin}{\let\&=\pgfmatrixnextcell}
  {
    \node {8}; \&[2mm] \node{1}; \&[-1mm] \node {6}; \\
    \node {3}; \& \node{5}; \& \node {7}; \\
    \node {4}; \& \node {9}; \& \node {2}; \\
  }
\end{tikzpicture}
```

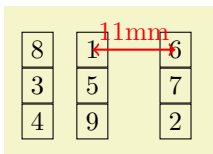

```
\begin{tikzpicture}[every node/.style=draw]
  \pgfsetmatrixcolumnsep{1mm}
  \pgfmatrix{rectangle}{center}{mymatrix}
  {\pgfusepath{}}{\pgfpointorigin}{\let\&=\pgfmatrixnextcell}
  {
    \node {8}; \&[2mm] \node(a){1}; \&[1cm,between origins] \node(b){6}; \\
    \node {3}; \& \node {5}; \& \node {7}; \\
    \node {4}; \& \node {9}; \& \node {2}; \\
  }
  \draw [<->,red,thick,every node/.style=] (a.center) -- (b.center)
    node [above,midway] {11mm};
\end{tikzpicture}
```

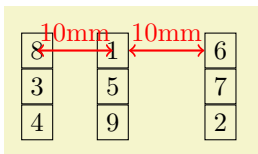

```
\begin{tikzpicture}[every node/.style=draw]
  \pgfsetmatrixcolumnsep{1cm,between origins}
  \pgfmatrix{rectangle}{center}{mymatrix}
  {\pgfusepath{}}{\pgfpointorigin}{\let\&=\pgfmatrixnextcell}
  {
    \node (a) {8}; \& \node (b) {1}; \&[between borders] \node (c) {6}; \\
    \node {3}; \& \node {5}; \& \node {7}; \\
    \node {4}; \& \node {9}; \& \node {2}; \\
  }
  \begin{scope}[every node/.style=]
    \draw [<->,red,thick] (a.center) -- (b.center) node [above,midway] {10mm};
    \draw [<->,red,thick] (b.east) -- (c.west) node [above,midway]
      {10mm};
  \end{scope}
\end{tikzpicture}
```

The mechanism for the between-row-spacing is the same, only the commands are called differently.

`\pgfsetmatrixrowsep{<sep list>}`

This macro sets the default separation list for rows.

`\pgfmatrixendrow[<additional sep list>]`

This command ends a line. The optional *<additional sep list>* is used to determine the spacing between the row being ended and the next row. The modes and the computation of *d* is done in the same way as for columns. For the last row the optional argument has no effect.

Inside matrices (and only there) the command `\` is setup to mean the same as this command.

## 76.5 Callbacks

There are three macros that get called at the beginning and end of cells. By redefining these macros, which are empty by default, you can change the appearance of cells in a very general manner.

### `\pgfmatrixemptycode`

This macro is executed for empty cells. This means that PGF uses some macro magic to determine whether a cell is empty (it immediately ends with `\pgfmatrixemptycode` or `\pgfmatrixendrow`) and, if so, put this macro inside the cell.

```
a   empty b
empty c   d empty
```

```
\begin{tikzpicture}
\def\pgfmatrixemptycode{\node{empty};}
\pgfmatrix{rectangle}{center}{mymatrix}
{\pgfusepath{}}{\pgfpointorigin}{\let\&=\pgfmatrixnextcell}
{
\node {a}; \&          \& \node {b}; \& \&
          \& \node{c}; \& \node {d}; \& \&
}
\end{tikzpicture}
```

As can be seen, the macro is not executed for empty cells at the end of row when columns are added only later on.

### `\pgfmatrixbegincode`

This macro is executed at the beginning of non-empty cells. Correspondingly, `\pgfmatrixendcode` is added at the end of every non-empty cell.

```
a b c
d   e
```

```
\begin{tikzpicture}
\def\pgfmatrixbegincode{\node[draw]\bgroup}
\def\pgfmatrixendcode{\egroup;}
\pgfmatrix{rectangle}{center}{mymatrix}
{\pgfusepath{}}{\pgfpointorigin}{\let\&=\pgfmatrixnextcell}
{
a \& b \& c \& \&
d \&   \& e \& \&
}
\end{tikzpicture}
```

Note that between `\pgfmatrixbegincode` and `\pgfmatrixendcode` there will *not* only be the contents of the cell. Rather, PGF will add some (invisible) commands for book-keeping purposes that involve `\let` and `\gdef`. In particular, it is not a good idea to have `\pgfmatrixbegincode` end with `\csname` and `\pgfmatrixendcode` start with `\endcsname`.

### `\pgfmatrixendcode`

See the explanation above.

The following two counters allow you to access the current row and current column in a callback:

### `\pgfmatrixcurrentrow`

This counter stores the current row of the current cell of the matrix. Do not even think of changing this counter.

### `\pgfmatrixcurrentcolumn`

This counter stores the current column of the current cell of the matrix.

## 77 Coordinate and Canvas Transformations

### 77.1 Overview

PGF offers two different ways of scaling, shifting, and rotating (these operations are generally known as *transformations*) graphics: You can apply *coordinate transformations* to all coordinates and you can apply *canvas transformations* to the canvas on which you draw. (The names “coordinate” and “canvas” transformations are not standard, I introduce them only for the purposes of this manual.)

The difference is the following:

- As the name “coordinate transformation” suggests, coordinate transformations apply only to coordinates. For example, when you specify a coordinate like `\pgfpoint{1cm}{2cm}` and you wish to “use” this coordinate—for example as an argument to a `\pgfpathmoveto` command—then the coordinate transformation matrix is applied to the coordinate, resulting in a new coordinate. Continuing the example, if the current coordinate transformation is “scale by a factor of two,” the coordinate `\pgfpoint{1cm}{2cm}` actually designates the point (2cm, 4cm).

Note that coordinate transformations apply *only* to coordinates. They do not apply to, say, line width or shadings or text.

- The effect of a “canvas transformation” like “scale by a factor of two” can be imagined as follows: You first draw your picture on a “rubber canvas” normally. Then, once you are done, the whole canvas is transformed, in this case stretched by a factor of two. In the resulting image *everything* will be larger: Text, lines, coordinates, and shadings.

In many cases, it is preferable that you use coordinate transformations and not canvas transformations. When canvas transformations are used, PGF loses track of the coordinates of nodes and shapes. Also, canvas transformations often cause undesirable effects like changing text size. For these reasons, PGF makes it easy to setup the coordinate transformation, but a bit harder to change the canvas transformation.

### 77.2 Coordinate Transformations

#### 77.2.1 How PGF Keeps Track of the Coordinate Transformation Matrix

PGF has an internal coordinate transformation matrix. This matrix is applied to coordinates “in certain situations.” This means that the matrix is not always applied to every coordinate “no matter what.” Rather, PGF tries to be reasonably smart at when and how this matrix should be applied. The most prominent examples are the path construction commands, which apply the coordinate transformation matrix to their inputs.

The coordinate transformation matrix consists of four numbers  $a$ ,  $b$ ,  $c$ , and  $d$ , and two dimensions  $s$  and  $t$ . When the coordinate transformation matrix is applied to a coordinate  $(x, y)$  the new coordinate  $(ax + by + s, cx + dy + t)$  results. For more details on how transformation matrices work in general, please see, for example, the PDF or PostScript reference or a textbook on computer graphics.

The coordinate transformation matrix is equal to the identity matrix at the beginning. More precisely,  $a = 1$ ,  $b = 0$ ,  $c = 0$ ,  $d = 1$ ,  $s = 0pt$ , and  $t = 0pt$ .

The different coordinate transformation commands will modify the matrix by concatenating it with another transformation matrix. This way the effect of applying several transformation commands will *accumulate*.

The coordinate transformation matrix is local to the current  $\TeX$  group (unlike the canvas transformation matrix, which is local to the current `{pgfscope}`). Thus, the effect of adding a coordinate transformation to the coordinate transformation matrix will last only till the end of the current  $\TeX$  group.

#### 77.2.2 Commands for Relative Coordinate Transformations

The following commands add a basic coordinate transformation to the current coordinate transformation matrix. For all commands, the transformation is applied *in addition* to any previous coordinate transformations.

`\pgftransformshift{⟨point⟩}`

Shifts coordinates by  $\langle point \rangle$ .

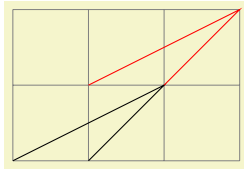

```
\begin{tikzpicture}
\draw[help lines] (0,0) grid (3,2);
\draw (0,0) -- (2,1) -- (1,0);
\pgftransformshift{\pgfpoint{1cm}{1cm}}
\draw[red] (0,0) -- (2,1) -- (1,0);
\end{tikzpicture}
```

### `\pgftransformxshift{<dimension>}`

Shifts coordinates by *<dimension>* along the *x*-axis.

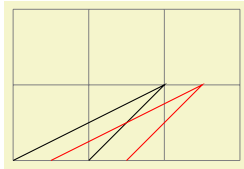

```
\begin{tikzpicture}
\draw[help lines] (0,0) grid (3,2);
\draw (0,0) -- (2,1) -- (1,0);
\pgftransformxshift{.5cm}
\draw[red] (0,0) -- (2,1) -- (1,0);
\end{tikzpicture}
```

### `\pgftransformyshift{<dimension>}`

Like `\pgftransformxshift`, only for the *y*-axis.

### `\pgftransformscale{<factor>}`

Scales coordinates by *<factor>*.

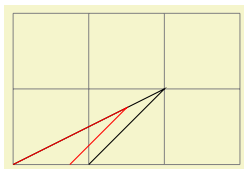

```
\begin{tikzpicture}
\draw[help lines] (0,0) grid (3,2);
\draw (0,0) -- (2,1) -- (1,0);
\pgftransformscale{.75}
\draw[red] (0,0) -- (2,1) -- (1,0);
\end{tikzpicture}
```

### `\pgftransformxscale{<factor>}`

Scales coordinates by *<factor>* in the *x*-direction.

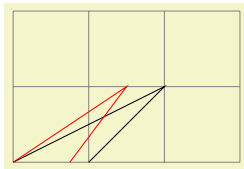

```
\begin{tikzpicture}
\draw[help lines] (0,0) grid (3,2);
\draw (0,0) -- (2,1) -- (1,0);
\pgftransformxscale{.75}
\draw[red] (0,0) -- (2,1) -- (1,0);
\end{tikzpicture}
```

### `\pgftransformyscale{<factor>}`

Like `\pgftransformxscale`, only for the *y*-axis.

### `\pgftransformxslant{<factor>}`

Slants coordinates by *<factor>* in the *x*-direction. Here, a factor of 1 means 45°.

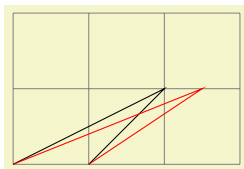

```
\begin{tikzpicture}
\draw[help lines] (0,0) grid (3,2);
\draw (0,0) -- (2,1) -- (1,0);
\pgftransformxslant{.5}
\draw[red] (0,0) -- (2,1) -- (1,0);
\end{tikzpicture}
```

### `\pgftransformyslant{<factor>}`

Slants coordinates by *<factor>* in the *y*-direction.

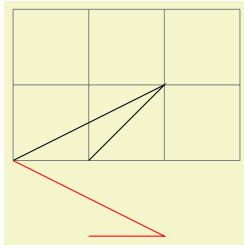

```
\begin{tikzpicture}
\draw[help lines] (0,0) grid (3,2);
\draw (0,0) -- (2,1) -- (1,0);
\pgftransformslant{-1}
\draw[red] (0,0) -- (2,1) -- (1,0);
\end{tikzpicture}
```

### `\pgftransformrotate{<degrees>}`

Rotates coordinates counterclockwise by  $\langle degrees \rangle$ .

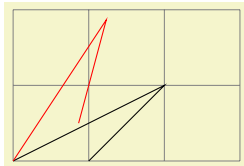

```
\begin{tikzpicture}
\draw[help lines] (0,0) grid (3,2);
\draw (0,0) -- (2,1) -- (1,0);
\pgftransformrotate{30}
\draw[red] (0,0) -- (2,1) -- (1,0);
\end{tikzpicture}
```

### `\pgftransformtriangle{<a>}{<b>}{<c>}`

This command transforms the coordinate system in such a way that the triangle given by the points  $\langle a \rangle$ ,  $\langle b \rangle$  and  $\langle c \rangle$  lies at the coordinates (0,0), (1pt,0pt) and (0pt,1pt).

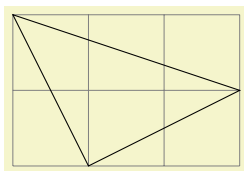

```
\begin{tikzpicture}
\draw[help lines] (0,0) grid (3,2);
\pgftransformtriangle
{\pgfpoint{1cm}{0cm}}
{\pgfpoint{0cm}{2cm}}
{\pgfpoint{3cm}{1cm}}
\draw (0,0) -- (1pt,0pt) -- (0pt,1pt) -- cycle;
\end{tikzpicture}
```

### `\pgftransformcm{<a>}{<b>}{<c>}{<d>}{<point>}`

Applies the transformation matrix given by  $a$ ,  $b$ ,  $c$ , and  $d$  and the shift  $\langle point \rangle$  to coordinates (in addition to any previous transformations already in force).

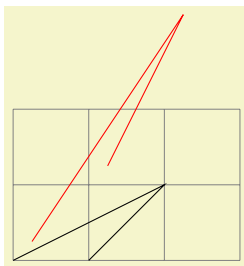

```
\begin{tikzpicture}
\draw[help lines] (0,0) grid (3,2);
\draw (0,0) -- (2,1) -- (1,0);
\pgftransformcm{1}{1}{0}{1}{\pgfpoint{.25cm}{.25cm}}
\draw[red] (0,0) -- (2,1) -- (1,0);
\end{tikzpicture}
```

### `\pgftransformarrow{<start>}{<end>}`

Shift coordinates to the end of the line going from  $\langle start \rangle$  to  $\langle end \rangle$  with the correct rotation.

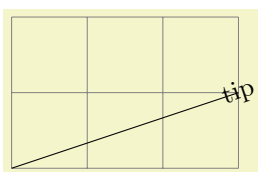

```
\begin{tikzpicture}
\draw[help lines] (0,0) grid (3,2);
\draw (0,0) -- (3,1);
\pgftransformarrow{\pgfpointorigin}{\pgfpoint{3cm}{1cm}}
\pgftext{tip}
\end{tikzpicture}
```

### `\pgftransformlineatime{<time>}{<start>}{<end>}`

Shifts coordinates by a specific point on a line at a specific time. The point by which the coordinate is shifted is calculated by calling `\pgfpointlineatime`, see Section 70.5.2.

In addition to shifting the coordinate, a rotation *may* also be applied. Whether this is the case depends on whether the T<sub>E</sub>X if `\ifpgfslopedattime` is set to true or not.

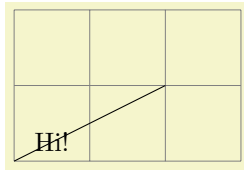

```
\begin{tikzpicture}
\draw[help lines] (0,0) grid (3,2);
\draw (0,0) -- (2,1);
\pgftransformlineattime{.25}{\pgfpointorigin}{\pgfpoint{2cm}{1cm}}
\pgftext{Hi!}
\end{tikzpicture}
```

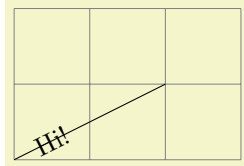

```
\begin{tikzpicture}
\draw[help lines] (0,0) grid (3,2);
\draw (0,0) -- (2,1);
\pgfslopedattimetrue
\pgftransformlineattime{.25}{\pgfpointorigin}{\pgfpoint{2cm}{1cm}}
\pgftext{Hi!}
\end{tikzpicture}
```

If `\ifpgfslopedattime` is true, another T<sub>E</sub>X if is important: `\ifpgfallowupsidedowattime`. If this is false, PGF will ensure that the rotation is done in such a way that text is never “upside down.”

There is another T<sub>E</sub>X if that influences this command. If you set `\ifpgfresetnontranslationattime` to true, then, between shifting the coordinate and (possibly) rotating/sloping the coordinate, the command `\pgftransformresetnontranslations` is called. See the description of this command for details.

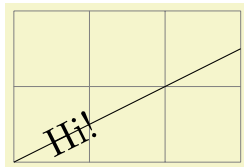

```
\begin{tikzpicture}
\draw[help lines] (0,0) grid (3,2);
\pgftransformscale{1.5}
\draw (0,0) -- (2,1);
\pgfslopedattimetrue
\pgfresetnontranslationattimefalse
\pgftransformlineattime{.25}{\pgfpointorigin}{\pgfpoint{2cm}{1cm}}
\pgftext{Hi!}
\end{tikzpicture}
```

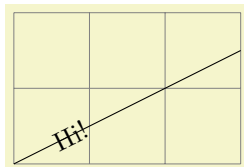

```
\begin{tikzpicture}
\draw[help lines] (0,0) grid (3,2);
\pgftransformscale{1.5}
\draw (0,0) -- (2,1);
\pgfslopedattimetrue
\pgfresetnontranslationattimetrue
\pgftransformlineattime{.25}{\pgfpointorigin}{\pgfpoint{2cm}{1cm}}
\pgftext{Hi!}
\end{tikzpicture}
```

`\pgftransformcurveattime`{(time)}{(start)}{(first support)}{(second support)}{(end)}

Shifts coordinates by a specific point on a curve at a specific time, see Section 70.5.2 once more.

As for the line-at-time transformation command, `\ifpgfslopedattime` decides whether an additional rotation should be applied. Again, the value of `\ifpgfallowupsidedowattime` is also considered.

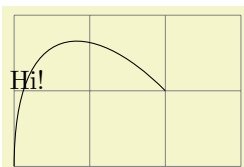

```
\begin{tikzpicture}
\draw[help lines] (0,0) grid (3,2);
\draw (0,0) .. controls (0,2) and (1,2) .. (2,1);
\pgftransformcurveattime{.25}{\pgfpointorigin}
{\pgfpoint{0cm}{2cm}}{\pgfpoint{1cm}{2cm}}{\pgfpoint{2cm}{1cm}}
\pgftext{Hi!}
\end{tikzpicture}
```

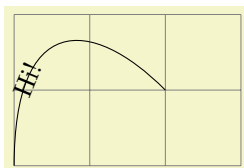

```
\begin{tikzpicture}
\draw[help lines] (0,0) grid (3,2);
\draw (0,0) .. controls (0,2) and (1,2) .. (2,1);
\pgfslopedattimetrue
\pgftransformcurveattime{.25}{\pgfpointorigin}
{\pgfpoint{0cm}{2cm}}{\pgfpoint{1cm}{2cm}}{\pgfpoint{2cm}{1cm}}
\pgftext{Hi!}
\end{tikzpicture}
```

The value of `\ifpgfresetnontranslationsattime` is also taken into account.

### `\ifpgfslopedatetime`

Decides whether the “at time” transformation commands also rotate coordinates or not.

### `\ifpgfallowupsideowntime`

Decides whether the “at time” transformation commands should allow the rotation be down in such a way that “upside-down text” can result.

### `\ifpgfresetnontranslationsatime`

Decides whether the “at time” transformation commands should reset the non-translations between shifting and rotating.

## 77.2.3 Commands for Absolute Coordinate Transformations

The coordinate transformation commands introduced up to now are always applied in addition to any previous transformations. In contrast, the commands presented in the following can be used to change the transformation matrix “absolutely.” Note that this is, in general, dangerous and will often produce unexpected effects. You should use these commands only if you really know what you are doing.

### `\pgftransformreset`

Resets the coordinate transformation matrix to the identity matrix. Thus, once this command is given no transformations are applied till the end of the scope.

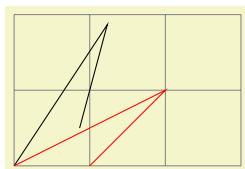

```
\begin{tikzpicture}
\draw[help lines] (0,0) grid (3,2);
\pgftransformrotate{30}
\draw (0,0) -- (2,1) -- (1,0);
\pgftransformreset
\draw[red] (0,0) -- (2,1) -- (1,0);
\end{tikzpicture}
```

### `\pgftransformresetnontranslations`

This command sets the  $a$ ,  $b$ ,  $c$ , and  $d$  part of the coordinate transformation matrix to  $a = 1$ ,  $b = 0$ ,  $c = 0$ , and  $d = 1$ . However, the current shifting of the matrix is not modified.

The effect of this command is that any rotation/scaling/slanting is undone in the current  $\text{\TeX}$  group, but the origin is not “moved back.”

This command is mostly useful directly before a `\pgftext` command to ensure that the text is not scaled or rotated.



```
\begin{tikzpicture}
\draw[help lines] (0,0) grid (3,2);
\pgftransformscale{2}
\pgftransformrotate{30}
\pgftransformxshift{1cm}
{\color{red}\pgftext{rotated}}
\pgftransformresetnontranslations
\pgftext{shifted only}
\end{tikzpicture}
```

### `\pgftransforminvert`

Replaces the coordinate transformation matrix by a coordinate transformation matrix that “exactly undoes the original transformation.” For example, if the original transformation was “scale by 2 and then shift right by 1cm” the new one is “shift left by 1cm and then scale by 1/2.”

This command will produce an error if the determinant of the matrix is too small, that is, if the matrix is near-singular.

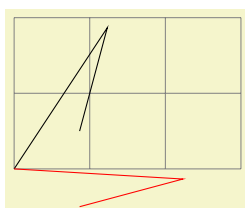

```
\begin{tikzpicture}
\draw[help lines] (0,0) grid (3,2);
\pgftransformrotate{30}
\draw (0,0) -- (2,1) -- (1,0);
\pgftransforminvert
\draw[red] (0,0) -- (2,1) -- (1,0);
\end{tikzpicture}
```



## 77.2.4 Saving and Restoring the Coordinate Transformation Matrix

There are two commands for saving and restoring coordinate transformation matrices.

`\pgfgettransform{macro}`

This command will (locally) define *macro* to a representation of the current coordinate transformation matrix. This matrix can later on be reinstalled using `\pgfsettransform`.

`\pgfsettransform{macro}`

Reinstalls a coordinate transformation matrix that was previously saved using `\pgfgettransform`.

## 77.3 Canvas Transformations

The canvas transformation matrix is not managed by PGF, but by the output format like PDF or PostScript. All the PGF does is to call appropriate low-level `\pgfsys@` commands to change the canvas transformation matrix.

Unlike coordinate transformations, canvas transformations apply to “everything,” including images, text, shadings, line thickness, and so on. The idea is that a canvas transformation really stretches and deforms the canvas after the graphic is finished.

Unlike coordinate transformations, canvas transformations are local to the current `{pgfscope}`, not to the current  $\text{T}_{\text{E}}\text{X}$  group. This is due to the fact that they are managed by the backend driver, not by  $\text{T}_{\text{E}}\text{X}$  or PGF.

Unlike the coordinate transformation matrix, it is not possible to “reset” the canvas transformation matrix. The only way to change it is to concatenate it with another canvas transformation matrix or to end the current `{pgfscope}`.

Unlike coordinate transformations, PGF does not “keep track” of canvas transformations. In particular, it will not be able to correctly save the coordinates of shapes or nodes when a canvas transformation is used.

PGF does not offer a whole set of special commands for modifying the canvas transformation matrix. Instead, different commands allow you to concatenate the canvas transformation matrix with a coordinate transformation matrix (and there are numerous commands for specifying a coordinate transformation, see the previous section).

`\pgflowlevelsynccm`

This command concatenates the canvas transformation matrix with the current coordinate transformation matrix. Afterward, the coordinate transformation matrix is reset.

The effect of this command is to “synchronize” the coordinate transformation matrix and the canvas transformation matrix. All transformations that were previously applied by the coordinate transformations matrix are now applied by the canvas transformation matrix.

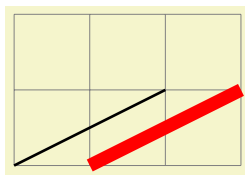

```
\begin{tikzpicture}
\draw[help lines] (0,0) grid (3,2);
\pgfsetlinewidth{1pt}
\pgftransformscale{5}
\draw (0,0) -- (0.4,.2);
\pgftransformxshift{0.2cm}
\pgflowlevelsynccm
\draw[red] (0,0) -- (0.4,.2);
\end{tikzpicture}
```

`\pgflowlevel{transformation code}`

This command concatenates the canvas transformation matrix with the coordinate transformation specified by *transformation code*.

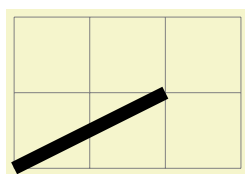

```
\begin{tikzpicture}
\draw[help lines] (0,0) grid (3,2);
\pgfsetlinewidth{1pt}
\pgflowlevel{\pgftransformscale{5}}
\draw (0,0) -- (0.4,.2);
\end{tikzpicture}
```

`\pgflowlevelobj`{*transformation code*}{*code*}

This command creates a local `{pgfscope}`. Inside this scope, `\pgflowlevel` is first called with the argument *transformation code*, then the *code* is inserted.

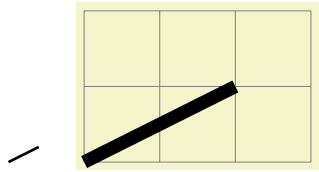

```
\begin{tikzpicture}
  \draw[help lines] (0,0) grid (3,2);
  \pgfsetlinewidth{1pt}
  \pgflowlevelobj{\pgftransformscale{5}} {\draw (0,0) -- (0.4,.2);}
  \pgflowlevelobj{\pgftransformxshift{-1cm}}{\draw (0,0) -- (0.4,.2);}
\end{tikzpicture}
```

`\begin{pgflowlevelscope}`{*transformation code*}

*environment contents*

`\end{pgflowlevelscope}`

This environment first surrounds the *environment contents* by a `{pgfscope}`. Then it calls `\pgflowlevel` with the argument *transformation code*.

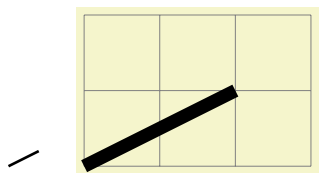

```
\begin{tikzpicture}
  \draw[help lines] (0,0) grid (3,2);
  \pgfsetlinewidth{1pt}
  \begin{pgflowlevelscope}{\pgftransformscale{5}}
    \draw (0,0) -- (0.4,.2);
  \end{pgflowlevelscope}
  \begin{pgflowlevelscope}{\pgftransformxshift{-1cm}}
    \draw (0,0) -- (0.4,.2);
  \end{pgflowlevelscope}
\end{tikzpicture}
```

`\pgflowlevelscope`{*transformation code*}

*environment contents*

`\endpgflowlevelscope`

Plain  $\text{T}_{\text{E}}\text{X}$  version of the environment.

`\startpgflowlevelscope`{*transformation code*}

*environment contents*

`\stoppgflowlevelscope`

Con $\text{T}_{\text{E}}\text{X}$ t version of the environment.

## 78 Patterns

### 78.1 Overview

There are many ways of filling a path. First, you can fill it using a solid color and this is also the fastest method. Second, you can also fill it using a shading, which means that the color changes smoothly between two (or more) different colors. Third, you can fill it using a tiling pattern and it is explained in the following how this is done.

A tiling pattern can be imagined as a rectangular tile (hence the name) on which a small picture is painted. There is not a single tile, but (conceptually) an infinite number of tiles, all showing the same picture, and these tiles are arranged horizontally and vertically to fill the plane. When you use a tiling pattern to fill a path, what happens is that the path clips out a “window” through which we see part of this infinite plane.

Patterns come in two versions: *inherently colored patterns* and *form-only patterns*. (These are often called “color patterns” and “uncolored patterns,” but these names are misleading since uncolored patterns do have a color and the color changes. As I said, the name is misleading. . .) An inherently colored pattern is just a colored tile like, say, a red star with a black outline. A form-only pattern can be imagined as a tile that is a kind of rubber stamp. When this pattern is used, the stamp is used to print copies of the stamp picture onto the plane, but we can use a different stamp color each time we use a form-only pattern.

PGF provides a special support for patterns. You can declare a pattern and then use it very much like a fill color. PGF directly maps patterns to the pattern facilities of the underlying graphic languages (PostScript, PDF, and SVG). This means that filling a path using a pattern will be nearly as fast as if you used a uniform color.

There are a number of pitfalls and restrictions when using patterns. First, once a pattern has been declared, you cannot change it anymore. In particular, it is not possible to enlarge it or change the line width. Such flexibility would require that the repeating of the pattern were not done by the graphic language, but on the PGF level. This would make patterns orders of magnitude slower to produce and to render. However, PGF does provide a more-or-less successful emulation of “mutable” patterns, although internally, a new (fixed) instance of a pattern is declared when the parameters of a pattern change.

Second, the phase of patterns is not well-defined, that is, it is not clear where origin of the “first” tile is. To be more precise, PostScript and PDF on the one hand and SVG on the other hand define the origin differently. PostScript and PDF define a fixed origin that is independent of where the path lies. This has the highly desirable effect that if you use the same pattern to fill multiple paths, this has the same effect as if you used the pattern to fill a single path that is the union of all the paths. By comparison, SVG uses the upper-left (?) corner of the path to be filled as the origin. However, the SVG specification is a bit vague on this question.

### 78.2 Declaring a Pattern

Before a pattern can be used, it must be declared. The following command is used for this:

```
\pgfdeclarepatternformonly[<variables>]{<name>}{<bottom left>}{<top right>}{<tile size>}{<code>}
```

This command declares a new form-only pattern. The `{<name>}` is a name for later reference. The two parameters `{<lower left>}` and `{<upper right>}` must describe a bounding box that is large enough to encompass the complete tile.

The size of a tile is given by `<tile size>`, that is, a tile is a rectangle whose lower left corner is the origin and whose upper right corner is given by `<tile size>`. This might make you wonder why the second and third parameters are needed. First, the bounding box might be smaller than the tile size if the tile is larger than the picture on the tile. Second, the bounding box might be bigger, in which case the picture will “bleed” over the tile.

The `<code>` should be PGF code than can be protocolled. It should not contain any color code.

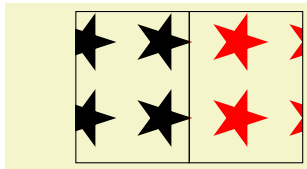

```

\pgfdeclarepatternformonly{stars}
{\pgfpointorigin}{\pgfpoint{1cm}{1cm}}
{\pgfpoint{1cm}{1cm}}
{
  \pgftransformshift{\pgfpoint{.5cm}{.5cm}}
  \pgfpathmoveto{\pgfpointpolar{0}{4mm}}
  \pgfpathlineto{\pgfpointpolar{144}{4mm}}
  \pgfpathlineto{\pgfpointpolar{288}{4mm}}
  \pgfpathlineto{\pgfpointpolar{72}{4mm}}
  \pgfpathlineto{\pgfpointpolar{216}{4mm}}
  \pgfpathclose%
  \pgfusepath{fill}
}
\begin{tikzpicture}
  \filldraw[pattern=stars] (0,0) rectangle (1.5,2);
  \filldraw[pattern=stars,pattern color=red]
            (1.5,0) rectangle (3,2);
\end{tikzpicture}

```

The optional argument  $\langle variables \rangle$  consists of a comma separated list of macros, registers or keys, representing the parameters of the pattern that may vary. If a variable is a key, then the full path name must be used (specifically, it must start with /). As an example, a list might look like the following:  $\backslash\text{mymacro}$ ,  $\backslash\text{mydimen}$ ,  $\text{/pgf/my key}$ . Note that macros and keys should be “simple”. They should only store values in themselves.

The effect of  $\langle variables \rangle$ , is the following: Normally, when this argument is empty, once a pattern has been declared, it becomes “frozen”. This means that it is not possible to enlarge the pattern or change the line width later on. By specifying  $\langle variables \rangle$  no pattern is actually created. Instead, the arguments are stored away (so the macros, registers or keys do not have to be defined in advance).

When the fill patten is set, PGF checks if the pattern has already been created with the  $\langle variables \rangle$  set to their current values (PGF is usually “smart enough” to distinguish between macros, registers and keys). If so, this already-declared-pattern is used as the fill pattern. If not, a new instance of the pattern (which will have a unique internal name) is declared using the current values of  $\langle variables \rangle$ . These values are then saved and the fill pattern set accordingly.

The following shows an example of a pattern which varies according to the values of the macro  $\backslash\text{size}$ , the key  $\text{/tikz/radius}$ , and the T<sub>E</sub>X dimension  $\backslash\text{thickness}$ .

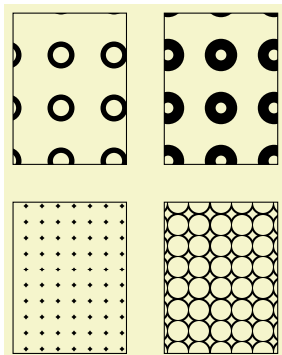

```

\pgfdeclarepatternformonly[/tikz/radius,\thickness,\size]{rings}
{\pgfpoint{-0.5*\size}{-0.5*\size}}
{\pgfpoint{0.5*\size}{0.5*\size}}
{\pgfpoint{\size}{\size}}
{
  \pgfsetlinewidth{\thickness}
  \pgfpathcircle\pgfpointorigin{\pgfkeysvalueof{/tikz/radius}}
  \pgfusepath{stroke}
}
\newdimen\thickness
\tikzset{
  radius/.initial=4pt,
  size/.store in=\size, size=20pt,
  thickness/.code={\thickness=#1},
  thickness=0.75pt
}
\begin{tikzpicture}[rings/.style={pattern=rings}]
  \filldraw [rings, radius=2pt, size=6pt] (0,0) rectangle +(1.5,2);
  \filldraw [rings, radius=2pt, size=8pt] (2,0) rectangle +(1.5,2);
  \filldraw [rings, radius=6pt, thickness=2pt] (0,2.5) rectangle +(1.5,2);
  \filldraw [rings, radius=8pt, thickness=4pt] (2,2.5) rectangle +(1.5,2);
\end{tikzpicture}

```

$\backslash\text{pgfdeclarepatterninherentlycolored}[\langle variables \rangle] \{ \langle name \rangle \} \{ \langle lower left \rangle \} \{ \langle upper right \rangle \} \{ \langle tile size \rangle \}$   
 $\{ \langle code \rangle \}$

This command works like  $\backslash\text{pgfdeclarepatternuncolored}$ , only the pattern will have an inherent color. To set the color, you should use PGF’s color commands, not the  $\backslash\text{color}$  command, since this fill is not protocolled.

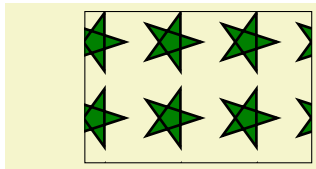

```

\pgfdeclarepatterninherentlycolored{green stars}
{\pgfpointorigin}{\pgfpoint{1cm}{1cm}}
{\pgfpoint{1cm}{1cm}}
{
  \pgfsetfillcolor{green!50!black}
  \pgftransformshift{\pgfpoint{.5cm}{.5cm}}
  \pgfpathmoveto{\pgfpointpolar{0}{4mm}}
  \pgfpathlineto{\pgfpointpolar{144}{4mm}}
  \pgfpathlineto{\pgfpointpolar{288}{4mm}}
  \pgfpathlineto{\pgfpointpolar{72}{4mm}}
  \pgfpathlineto{\pgfpointpolar{216}{4mm}}
  \pgfpathclose%
  \pgfusepath{stroke,fill}
}
\begin{tikzpicture}
  \filldraw[pattern=green stars] (0,0) rectangle (3,2);
\end{tikzpicture}

```

### 78.3 Setting a Pattern

Once a pattern has been declared, it can be used.

`\pgfsetfillpattern{<name>}{<color>}`

This command specifies that paths that are filled should be filled with the “color” by the pattern *<name>*. For an inherently colored pattern, the *<color>* parameter is ignored. For form-only patterns, the *<color>* parameter specified the color to be used for the pattern.

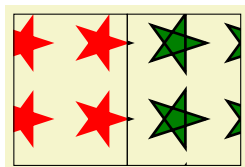

```

\begin{tikzpicture}
  \pgfsetfillpattern{stars}{red}
  \filldraw (0,0) rectangle (1.5,2);

  \pgfsetfillpattern{green stars}{red}
  \filldraw (1.5,0) rectangle (3,2);
\end{tikzpicture}

```

## 79 Declaring and Using Images

This section describes the commands for creating images.

### 79.1 Overview

To be quite frank, L<sup>A</sup>T<sub>E</sub>X's `\includegraphics` is designed better than PGF's image mechanism. For this reason, *I recommend that you use the standard image inclusion mechanism of your format.* Thus, L<sup>A</sup>T<sub>E</sub>X users are encouraged to use `\includegraphics` to include images.

However, there are reasons why you might need to use the image inclusion facilities of PGF:

- There is no standard image inclusion mechanism in your format. For example, plain T<sub>E</sub>X does not have one, so PGF's inclusion mechanism is “better than nothing.”

However, this applies only to the `pdftex` backend. For all other backends, PGF currently maps its commands back to the `graphicx` package. Thus, in plain T<sub>E</sub>X, this does not really help. It might be a good idea to fix this in the future such that PGF becomes independent of L<sup>A</sup>T<sub>E</sub>X, thereby providing a uniform image abstraction for all formats.

- You wish to use masking. This is a feature that is only supported by PGF, though I hope that someone will implement this also for the `graphics` package in L<sup>A</sup>T<sub>E</sub>X in the future.

Whatever your choice, you can still use the usual image inclusion facilities of the `graphics` package.

The general approach taken by PGF to including an image is the following: First, `\pgfdeclareimage` declares the image. This must be done prior to the first use of the image. Once you have declared an image, you can insert it into the text using `\pgfuseimage`. The advantage of this two-phase approach is that, at least for PDF, the image data will only be included once in the file. This can drastically reduce the file size if you use an image repeatedly, for example in an overlay. However, there is also a command called `\pgfimage` that declares and then immediately uses the image.

To speedup the compilation, you may wish to use the following class option:

```
\usepackage[draft]{pgf}
```

In draft mode boxes showing the image name replace the images. It is checked whether the image files exist, but they are not read. If either height or width is not given, 1cm is used instead.

### 79.2 Declaring an Image

```
\pgfdeclareimage[<options>]{<image name>}{<filename>}
```

Declares an image, but does not paint anything. To draw the image, use `\pgfuseimage{<image name>}`. The *<filename>* may not have an extension. For PDF, the extensions `.pdf`, `.jpg`, and `.png` will automatically be tried. For PostScript, the extensions `.eps`, `.epsi`, and `.ps` will be tried.

The following options are possible:

- **height**=*<dimension>* sets the height of the image. If the width is not specified simultaneously, the aspect ratio of the image is kept.
- **width**=*<dimension>* sets the width of the image. If the height is not specified simultaneously, the aspect ratio of the image is kept.
- **page**=*<page number>* selects a given page number from a multipage document. Specifying this option will have the following effect: first, PGF tries to find a file named

*<filename>.page<page number>.<extension>*

If such a file is found, it will be used instead of the originally specified filename. If not, PGF inserts the image stored in *<filename>.<extension>* and if a recent version of `pdflatex` is used, only the selected page is inserted. For older versions of `pdflatex` and for `dvips` the complete document is inserted and a warning is printed.

- **interpolate**=*<true or false>* selects whether the image should “smoothed” when zoomed. False by default.
- **mask**=*<mask name>* selects a transparency mask. The mask must previously be declared using `\pgfdeclaremask` (see below). This option only has an effect for `pdf`. Not all viewers support masking.

```
\pgfdeclareimage[interpolate=true,height=1cm]{image1}{brave-gnu-world-logo}
\pgfdeclareimage[interpolate=true,width=1cm,height=1cm]{image2}{brave-gnu-world-logo}
\pgfdeclareimage[interpolate=true,height=1cm]{image3}{brave-gnu-world-logo}
```

`\pgfaliasimage`{*new image name*}{*existing image name*}

The `{existing image name}` is “cloned” and the `{new image name}` can now be used whenever original image is used. This command is useful for creating aliases for alternate extensions and for accessing the last image inserted using `\pgfimage`.

*Example:* `\pgfaliasimage{image.!30!white}{image.!25!white}`

### 79.3 Using an Image

`\pgfuseimage`{*image name*}

Inserts a previously declared image into the *normal text*. If you wish to use it in a `{pgfpicture}` environment, you must put a `\pgftext` around it.

If the macro `\pgfalternateextension` expands to some nonempty *alternate extension*, PGF will first try to use the image names `image name.alternate extension`. If this image is not defined, PGF will next check whether *alternate extension* contains a ! character. If so, everything up to this exclamation mark and including it is deleted from *alternate extension* and the PGF again tries to use the image `image name.alternate extension`. This is repeated until *alternate extension* no longer contains a !. Then the original image is used.

The `xxcolor` package sets the alternate extension to the current color mixin.

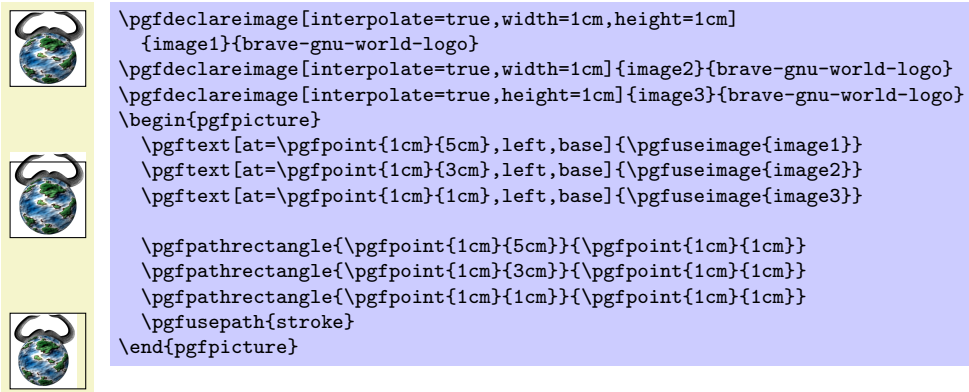

The following example demonstrates the effect of using `\pgfuseimage` inside a color mixin environment.

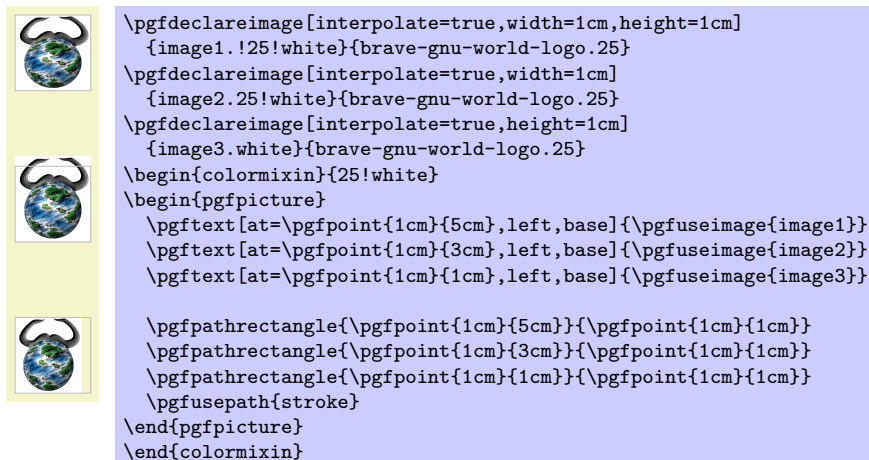

`\pgfalternateextension`

You should redefine this command to install a different alternate extension.

*Example:* `\def\pgfalternateextension{!25!white}`



`\pgfimage`[*options*]{*filename*}

Declares the image under the name `pgflastimage` and immediately uses it. You can “save” the image for later usage by invoking `\pgfaliasimage` on `pgflastimage`.

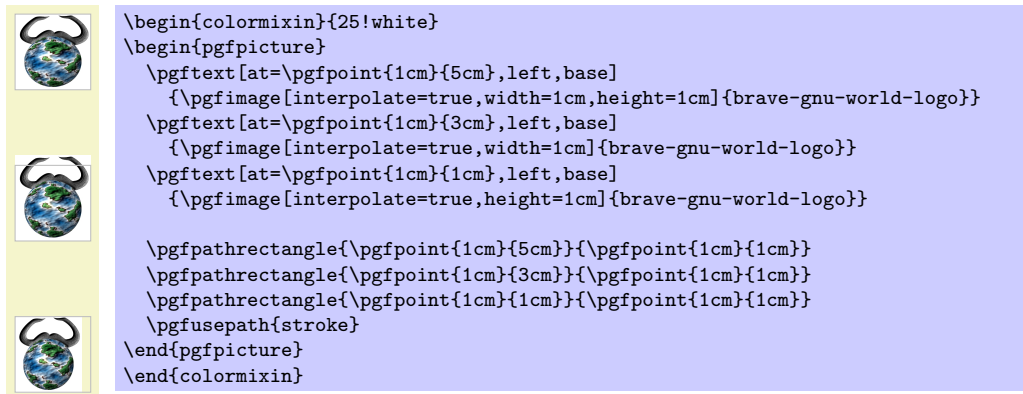

## 79.4 Masking an Image

`\pgfdeclaremask`[*options*]{*mask name*}{*filename*}

Declares a transparency mask named *mask name* (called a *soft mask* in the PDF specification). This mask is read from the file *filename*. This file should contain a grayscale image that is as large as the actual image. A white pixel in the mask will correspond to “transparent,” a black pixel to “solid,” and gray values correspond to intermediate values. The mask must have a single “color channel.” This means that the mask must be a “real” grayscale image, not an RGB-image in which all RGB-triples happen to have the same components.

You can only mask images that are in a “pixel format.” These are `.jpg` and `.png`. You cannot mask `.pdf` images in this way. Also, again, the mask file and the image file must have the same size.

The following options may be given:

- `matte={color components}` sets the so-called *matte* of the actual image (strangely, this has to be specified together with the mask, not with the image itself). The *matte* is the color that has been used to preblend the image. For example, if the image has been preblended with a red background, then *color components* should be set to `{1 0 0}`. The default is `{1 1 1}`, which is white in the rgb model.

The *matte* is specified in terms of the parent’s image color space. Thus, if the parent is a grayscale image, the *matte* has to be set to `{1}`.

*Example:*

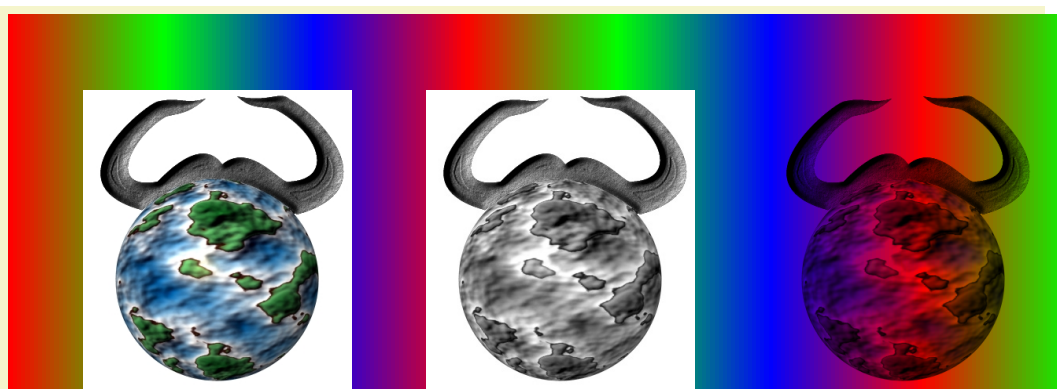



```

%% Draw a large colorful background
\pgfdeclarehorizontalshading{colorful}{5cm}{color(0cm)=(red);
color(2cm)=(green); color(4cm)=(blue); color(6cm)=(red);
color(8cm)=(green); color(10cm)=(blue); color(12cm)=(red);
color(14cm)=(green)}
\hbox{\pgfuses shading{colorful}\hskip-14cm\hskip1cm
\pgfimage[height=4cm]{brave-gnu-world-logo}\hskip1cm
\pgfimage[height=4cm]{brave-gnu-world-logo-mask}\hskip1cm
\pgfdeclaremask{mymask}{brave-gnu-world-logo-mask}
\pgfimage[mask=mymask,height=4cm,interpolate=true]{brave-gnu-world-logo}}

```

## 80 Externalizing Graphics

### 80.1 Overview

There are two fundamentally different ways of inserting graphics into a T<sub>E</sub>X-document. First, you can create a graphic using some external program like `xfig` or `InDesign` and then include this graphic in your text. This is done using commands like `\includegraphics` or `\pgfimage`. In this case, the graphic file contains all the low-level graphic commands that describe the picture. When such a file is included, all T<sub>E</sub>X has to worry about is the size of the picture; the internals of the picture are unknown to T<sub>E</sub>X and it does not care about them.

The second method of creating graphics is to use a special package that transforms T<sub>E</sub>X-commands like `\draw` or `\psline` into appropriate low-level graphic commands. In this case, T<sub>E</sub>X has to do all the hard work of “typesetting” the picture and if a picture has a complicated internal structure this may take a lot of time.

While PGF was created to facilitate the second method of creating pictures, there are two main reasons why you may need to employ the first method of image-inclusion, nevertheless:

1. Typesetting a picture using T<sub>E</sub>X can be a very time-consuming process. If T<sub>E</sub>X needs a minute to typeset a picture, you do not want to wait this minute when you reT<sub>E</sub>X your document after having changed a single comma.
2. Some users, especially journal editors, may not be able to process files that contain PGF commands – for the simple reason that the systems of many publishing houses do not have PGF installed.

In both cases, the solution is to “extract” or “externalize” pictures that would normally be typeset every time a document is T<sub>E</sub>Xed. Once the pictures have been extracted into separate graphics files, these graphic files can be reinserted into the text using the first method.

Extracting a graphic from a file is not as easy as it may sound at first since T<sub>E</sub>X cannot write parts of its output into different files and a bit of trickery is needed. The following macros simplify the workflow:

1. You have to tell PGF which files will be used for which pictures. To do so, you enclose each picture that you wish to be “externalized” in a pair of `\beginpgfgraphicnamed` and `\endpgfgraphicnamed` macros.
2. The next step is to generate the extracted graphics. For this you run T<sub>E</sub>X with the `\jobname` set to the graphic file’s name. This will cause `\pgfname` to behave in a very special way: All of your document will simply be thrown away, *except* for the single graphic having the same name as the current jobname.
3. After you have run T<sub>E</sub>X once for each graphic that you wish to externalize, you can rerun T<sub>E</sub>X on your document normally. This will have the following effect: Each time a `\beginpgfgraphicnamed` is encountered, PGF checks whether a graphic file of the given name exists (if you did step 2, it will). If this graphic file exists, it will be input and the text till the corresponding `\endpgfgraphicnamed` will be ignored.

In the rest of this section, the above workflow is explained in more detail.

### 80.2 Workflow Step 1: Naming Graphics

In order to put each graphic in an external file, you first need to tell PGF the names of these files.

`\beginpgfgraphicnamed{<file name prefix>}`

This command indicates that everything up to the next call of `\endpgfgraphicnamed` is part of a graphic that should be placed in a file named `<file name prefix>.<suffix>`, where the `<suffix>` depends on your backend driver. Typically, `<suffix>` will be `dvi` or `pdf`.

Here is a typical example of how this command is used:

```

% In file main.tex:
...
As we see in Figure~\ref{fig1}, the world is flat.
\begin{figure}
  \beginpgfgraphicnamed{graphic-of-flat-world}
  \begin{tikzpicture}
    \fill (0,0) circle (1cm);
  \end{tikzpicture}
  \endpgfgraphicnamed
  \caption{The flat world.}
  \label{fig1}
\end{figure}

```

Each graphic that is to be externalized should have a unique name. Note that this name will be used as the name of a file in the file system, so it should not contain any funny characters.

This command can have three different effects:

1. The easiest situation arises if there does not yet exist a graphic file called  $\langle file\ name\ prefix \rangle.\langle suffix \rangle$ , where the  $\langle suffix \rangle$  is one of the suffixes understood by your current backend driver (so `pdf` or `jpg` if you use `pdftex`, `eps` if you use `dvips`, and so on). In this case, both this command and the `\endpgfgraphicnamed` command simply have no effect.
2. A more complex situation arises when a graphic file named  $\langle file\ name\ prefix \rangle.\langle suffix \rangle$  does exist. In this case, this graphic file is included using the `\includegraphics` command<sup>5</sup>. Furthermore, the text between `\beginpgfgraphicnamed` and `\endpgfgraphicnamed` is ignored. When the text is “ignored,” what actually happens is that all text up to the next occurrence of `\endpgfgraphicnamed` is thrown away without any macro expansion. This means, in particular, that (a) you cannot put `\endpgfgraphicnamed` inside a macro and (b) the macros used in the graphics need not be defined at all when the graphic file is included.
3. The most complex behaviour arises when currently the `\jobname` equals the  $\langle file\ name\ prefix \rangle$  and, furthermore, the a *real job name* has been declared. The behaviour for this case is explained later.

Note that the `\beginpgfgraphicnamed` does not really have any effect until you have generated the graphic files named. Till then, this command is simply ignored. Also, if you delete the graphics file later on, the graphics are typeset normally once more.

### `\endpgfgraphicnamed`

This command just marks the end of the graphic that should be externalized.

## 80.3 Workflow Step 2: Generating the External Graphics

We have now indicated all the graphics for which we would like graphic files to be generated. In order to generate the files, you now need to modify the `\jobname` appropriately. This is done in two steps:

1. You use the following command to tell PGF the real name of your `.tex` file:

```
\pgfrealjobname{\name}
```

Tells PGF the real name of your job. For instance, if you have a file called `survey.tex` that contains two graphics that you wish to be called `survey-graphic1` and `survey-graphic2`, then you should write the following.

```

% This is file survey.tex
\documentclass{article}
...
\usepackage{tikz}
\pgfrealjobname{survey}

```

2. You run `TEX` with the `\jobname` set to the name of the graphic for which you need an external graphic to be generated. To set the `\jobname`, you use the `--jobname=` option of `TEX`:

```
bash> latex --jobname=survey-graphic1 survey.tex
```

<sup>5</sup>Actually, the command key `/pgf/images/include external` is invoked which calls an appropriate `\includegraphics` command.

The following things will now happen:

1. `\pgfrealjobname` notices that the `\jobname` is not the “real” jobname and, thus, must be the name of a graphic that is to be put in an external file.
2. At the beginning of the document, PGF changes the definition of  $\text{\TeX}$ ’s internal `\shipout` macro. The new shipout macro simply throws away the output. This means that the document is typeset normally, but no output is produced.
3. When the `\beginpgfgraphicnamed{<name>}` command is encountered where the `<name>` is the same as the current `\jobname`, then a  $\text{\TeX}$ -box is started and `<everything>` up to the following `\endpgfgraphicnamed` command is stored inside this box.  
Note that, typically, `<everything>` will contain just a single `{tikzpicture}` or `{pgfpicture}` environment. However, this need not be the case, you use, say, a `{pspicture}` environment as `<everything>` or even just some normal  $\text{\TeX}$ -text.
4. At the `\endpgfgraphicnamed`, the box *is* shipped out using the original `\shipout` command. Thus, unlike everything else, the contents of the graphic is made part of the output.
5. When the box containing the graphic is shipped out, the paper size is modified such that it exactly equal to the height and width of the box.

The net effect of everything described above is that the two commands

```
bash> latex --jobname=survey-graphic1 survey.tex
bash> dvips survey-graphic1
```

produce a file called `survey-graphic1.ps` that consists of a single page that contains exactly the graphic produced by the code between `\beginpgfgraphicnamed{survey-graphic1}` and `\endpgfgraphicnamed`. Furthermore, the size of this single page is exactly the size of the graphic.

If you use pdf $\text{\TeX}$ , producing the graphic is even simpler:

```
bash> pdflatex --jobname=survey-graphic1 survey.tex
```

produces the single-page pdf-file `survey-graphic1.pdf`.

## 80.4 Workflow Step 3: Including the External Graphics

Once you have produced all the pictures in the text, including them into the main document is easy: Simply run  $\text{\TeX}$  again without any modification of the `\jobname`. In this case the `\pgfrealjobname` command will notice that the main file is, indeed, the main file. The main file will then be typeset normally and the `\beginpgfgraphicnamed` commands also behave normally, which means that they will try to include the generated graphic files – which is exactly what you want.

Suppose that you wish to send your survey to a journal that does not have PGF installed. In this case, you now have all the necessary external graphics, but you still need PGF to automatically include them instead of the executing the picture code! One way to solve this problem is to simply delete all of the PGF or *TikZ* code from your `survey.tex` and instead insert appropriate `\includegraphics` commands “by hand.” However, there is a better way: You input the file `pgfexternal.tex`.

File `pgfexternal.tex`

This file defines the command `\beginpgfgraphicnamed` and causes it to have the following effect: It includes the graphic file given as a parameter to it and then gobbles everything up to `\endpgfgraphicnamed`.

Since `\beginpgfgraphicnamed` does not do macro expansion as it searches for `\endpgfgraphicnamed`, it is not necessary to actually include the packages necessary for *creating* the graphics. So the idea is that you comment out things like `\usepackage{tikz}` and instead say `\input pgfexternal.tex`.

Indeed, the contents of this file is simply the following line:

```
\long\def\beginpgfgraphicnamed#1#2\endpgfgraphicnamed{\includegraphics{#1}}
```

Instead of `\input pgfexternal.tex` you could also include this line in your main file.

As a final remark, note that the `baseline` option does not work directly with pictures written to an external graphic file. The simple reason is that there is no way to store this baseline information in an external graphic file. To allow the `baseline` option (or any  $\TeX$  construction with non-zero depth), the baseline information is stored into a separate file. This file is named  $\{\langle image\ file\rangle\}.dpth$  and contains something like 5pt.

So, if you need baseline information, you will have to keep the external graphic file together with its `.dpth` file. Furthermore, the short command in `\input pgfexternal.tex` is no longer enough because it ignores any baseline information. You will need to use `\input pgfexternalwithdepth.tex` instead (it is shown below). It is slightly longer, but it can be used in the same way as `pgfexternal.tex`.

`/pgf/images/include external` (initially `\pgfimage{#1}`)

This key constitutes the public interface to exchange the `\includegraphics` command used for the image inclusion.

Redefining this key allows to provide bounding box or viewport options:

```
\pgfkeys{/pgf/images/include external/.code={\includegraphics[viewport=0 0 211.28 175.686]{#1}}}
```

Do not forget the `.code` here which redefines the command.

One application could be image externalization and bounding box restrictions: As far as I know, a `.pdf` graphics with restricted bounding box is always cropped (which is not always desired). One solution could be to use `latex` and `dvips` which doesn't have this restriction. Another is to manually provide the `viewport` option as shown above.

A possible value for `viewport` can be found in the `.pdf` image, search for `/MediaBox = [ ... ]`.

## 80.5 A Complete Example

Let us now have a look at a simple, but complete example. We start out with a normal file called `survey.tex` that has the following contents:

```
% This is the file survey.tex
\documentclass{article}

\usepackage{graphics}
\usepackage{tikz}

\begin{document}
In the following figure, we see a circle:
\begin{tikzpicture}
  \fill (0,0) circle (10pt);
\end{tikzpicture}

By comparison, in this figure we see a rectangle:
\begin{tikzpicture}
  \fill (0,0) rectangle (10pt,10pt);
\end{tikzpicture}
\end{document}
```

Now our editor tells us that the publisher will need all figures to be provided in separate PostScript or `.pdf`-files. For this, we enclose all figures in `...graphicnamed-pairs` and we add a call to the `\pgfrealjobname` macro:

```

% This is the file survey.tex
\documentclass{article}

\usepackage{graphics}
\usepackage{tikz}
\pgfrealjobname{survey}

\begin{document}
In the following figure, we see a circle:
\beginpgfgraphicnamed{survey-f1}
\begin{tikzpicture}
  \fill (0,0) circle (10pt);
\end{tikzpicture}
\endpgfgraphicnamed

By comparison, in this figure we see a rectangle:
\beginpgfgraphicnamed{survey-f2}
\begin{tikzpicture}
  \fill (0,0) rectangle (10pt,10pt);
\end{tikzpicture}
\endpgfgraphicnamed
\end{document}

```

After these changes, typesetting the file will still yield the same output as it did before – after all, we have not yet created any external graphics.

To create the external graphics, we run `pdflatex` twice, once for each graphic:

```

bash> pdflatex --jobname=survey-f1 survey.tex
This is pdfTeX, Version 3.141592-1.40.3 (Web2C 7.5.6)
entering extended mode
(./survey.tex
LaTeX2e <2005/12/01>
...
) [1] (./survey-f1.aux) )
Output written on survey-f1.pdf (1 page, 1016 bytes).
Transcript written on survey-f1.log.

```

```

bash> pdflatex --jobname=survey-f2 survey.tex
This is pdfTeX, Version 3.141592-1.40.3 (Web2C 7.5.6)
entering extended mode
(./survey.tex
LaTeX2e <2005/12/01>
...
) [1] (./survey-f2.aux) )
Output written on survey-f2.pdf (1 page, 1002 bytes).
Transcript written on survey-f2.log.

```

We can now send the two generated graphics (`survey-f1.pdf` and `survey-f2.pdf`) to the editor. However, the publisher cannot use our `survey.tex` file, yet. The reason is that it contains the command `\usepackage{tikz}` and they do not have PGF installed.

Thus, we modify the main file `survey.tex` as follows:

```

% This is the file survey.tex
\documentclass{article}

\usepackage{graphics}
\input pgfexternal.tex
% \usepackage{tikz}
% \pgfrealjobname{survey}

\begin{document}
In the following figure, we see a circle:
\beginpgfgraphicnamed{survey-f1}
\begin{tikzpicture}
  \fill (0,0) circle (10pt);
\end{tikzpicture}
\endpgfgraphicnamed

By comparison, in this figure we see a rectangle:
\beginpgfgraphicnamed{survey-f2}
\begin{tikzpicture}
  \fill (0,0) rectangle (10pt,10pt);
\end{tikzpicture}
\endpgfgraphicnamed
\end{document}

```

If we now run pdfL<sup>A</sup>T<sub>E</sub>X, then, indeed, PGF is no longer needed:

```

bash> pdflatex survey.tex
This is pdfTeX, Version 3.141592-1.40.3 (Web2C 7.5.6)
entering extended mode
(./survey.tex
LaTeX2e <2005/12/01>
Babel <v3.8h> and hyphenation patterns for english, ..., loaded.
(/usr/local/gwTeX/texmf.texlive/tex/latex/base/article.cls
Document Class: article 2005/09/16 v1.4f Standard LaTeX document class
(/usr/local/gwTeX/texmf.texlive/tex/latex/base/size10.clo)
(/usr/local/gwTeX/texmf.texlive/tex/latex/graphics/graphics.sty
(/usr/local/gwTeX/texmf.texlive/tex/latex/graphics/trig.sty)
(/usr/local/gwTeX/texmf.texlive/tex/latex/config/graphics.cfg)
(/usr/local/gwTeX/texmf.texlive/tex/latex/pdftex-def/pdftex.def)
(/Users/tantau/Library/texmf/tex/generic/pgf/generic/pgf/utilities/pgfexternal.
tex) (./survey.aux)
(/usr/local/gwTeX/texmf.texlive/tex/context/base/supp-pdf.tex
[Loading MPS to PDF converter (version 2006.09.02).]
) <survey-f1.pdf, id=1, 23.33318pt x 19.99973pt> <use survey-f1.pdf>
<survey-f2.pdf, id=2, 13.33382pt x 10.00037pt> <use survey-f2.pdf> [1{/Users/ta
ntau/Library/texmf/fonts/map/pdftex/updmap/pdftex.map} <./survey-f1.pdf> <./sur
vey-f2.pdf>] (./survey.aux) </usr/local/gwTeX/texmf.texlive/fonts/type1/bluesk
y/cm/cmr10.pfb>
Output written on survey.pdf (1 page, 10006 bytes).
Transcript written on survey.log.

```

To our editor, we send the following files:

- The last `survey.tex` shown above.
- The graphic file `survey-f1.pdf`.
- The graphic file `survey-f2.pdf`.
- The file `pgfexternal.tex`, whose contents is simply

```
\long\def\beginpgfgraphicnamed#1#2\endpgfgraphicnamed{\includegraphics{#1}}
```

(Alternatively, we can also directly add this line to our `survey.tex` file).

In case we have used the `baseline` option, we also need to include any `.dpth` files and we need to use the file `pgfexternalwithdepth.tex` instead of `pgfexternal.tex`. This file also checks for the existence of `.dpth` files containing baseline information, its contents is

```
\long\def\beginpgfgraphicnamed#1#2\endpgfgraphicnamed{%
  \begingroup
  \setbox1=\hbox{\includegraphics{#1}}%
  \openin1=#1.dpth
  \ifeof1 \box1
  \else
    \read1 to\pgfincludeexternalgraphicsdp\closein1
    \dimen0=\pgfincludeexternalgraphicsdp\relax
    \hbox{\lower\dimen0 \box1 }%
  \fi
  \endgroup
}
```

Again, we could simply copy these lines to our `survey.tex` file.



## 81 Creating Plots

This section describes the `plot` module.

```
\usepgfmodule{plot} %  $\TeX$  and plain  $\TeX$  and pure pgf
\usepgfmodule[plot] % Con $\TeX$ t and pure pgf
```

This module provides a set of commands that are intended to make it reasonably easy to plot functions using PGF. It is loaded automatically by `pgf`, but you can load it manually if you have only included `pgfcore`.

### 81.1 Overview

There are different reasons for using PGF for creating plots rather than some more powerful program such as GNUPLOT or MATHEMATICA, as discussed in Section 19.1. So, let us assume that – for whatever reason – you wish to use PGF for generating a plot.

PGF (conceptually) uses a two-stage process for generating plots. First, a *plot stream* must be produced. This stream consists (more or less) of a large number of coordinates. Second a *plot handler* is applied to the stream. A plot handler “does something” with the stream. The standard handler will issue line-to operations to the coordinates in the stream. However, a handler might also try to issue appropriate curve-to operations in order to smooth the curve. A handler may even do something else entirely, like writing each coordinate to another stream, thereby duplicating the original stream.

Both for the creation of streams and the handling of streams different sets of commands exist. The commands for creating streams start with `\pgfplotstream`, the commands for setting the handler start with `\pgfplothandler`.

### 81.2 Generating Plot Streams

#### 81.2.1 Basic Building Blocks of Plot Streams

A *plot stream* is a (long) sequence of the following three commands:

1. `\pgfplotstreamstart`,
2. `\pgfplotstreampoint`, and
3. `\pgfplotstreamend`.

Between calls of these commands arbitrary other code may be called. Obviously, the stream should start with the first command and end with the last command. Here is an example of a plot stream:

```
\pgfplotstreamstart
\pgfplotstreampoint{\pgfpoint{1cm}{1cm}}
\newdimen\mydim
\mydim=2cm
\pgfplotstreampoint{\pgfpoint{\mydim}{2cm}}
\advance \mydim by 3cm
\pgfplotstreampoint{\pgfpoint{\mydim}{2cm}}
\pgfplotstreamend
```

#### `\pgfplotstreamstart`

This command signals that a plot stream starts. The effect of this command is to call the internal command `\pgf@plotstreamstart`, which is set by the current plot handler to do whatever needs to be done at the beginning of the plot.

#### `\pgfplotstreampoint{⟨point⟩}`

This command adds a *⟨point⟩* to the current plot stream. The effect of this command is to call the internal command `\pgf@plotstreampoint`, which is also set by the current plot handler. This command should now “handle” the point in some sensible way. For example, a line-to command might be issued for the point.

#### `\pgfplotstreamend`

This command signals that a plot stream ends. It calls `\pgf@plotstreamend`, which should now do any necessary “cleanup.”

Note that plot streams are not buffered, that is, the different points are handled immediately. However, using the recording handler, it is possible to record a stream.

### 81.2.2 Commands That Generate Plot Streams

Plot streams can be created “by hand” as in the earlier example. However, most of the time the coordinates will be produced internally by some command. For example, the `\pgfplotxyfile` reads a file and converts it into a plot stream.

`\pgfplotxyfile{filename}`

This command will try to open the file *filename*. If this succeeds, it will convert the file contents into a plot stream as follows: A `\pgfplotstreamstart` is issued. Then, each nonempty line of the file should start with two numbers separated by a space, such as `0.1 1` or `100 -3`. Anything following the numbers is ignored.

Each pair *x* and *y* of numbers is converted into one plot stream point in the xy-coordinate system. Thus, a line like

```
2 -5 some text
```

is turned into

```
\pgfplotstreampoint{\pgfpointxy{2}{-5}}
```

The two characters `%` and `#` are also allowed in a file and they are both treated as comment characters. Thus, a line starting with either of them is empty and, hence, ignored.

When the file has been read completely, `\pgfplotstreamend` is called.

`\pgfplotxyzfile{filename}`

This command works like `\pgfplotxyfile`, only *three* numbers are expected on each non-empty line. They are converted into points in the xyz-coordinate system. Consider, the following file:

```
% Some comments
# more comments
2 -5 1 first entry
2 -.2 2 second entry
2 -5 2 third entry
```

It is turned into the following stream:

```
\pgfplotstreamstart
\pgfplotstreampoint{\pgfpointxyz{2}{-5}{1}}
\pgfplotstreampoint{\pgfpointxyz{2}{-.2}{2}}
\pgfplotstreampoint{\pgfpointxyz{2}{-5}{2}}
\pgfplotstreamend
```

Currently, there is no command that can decide automatically whether the xy-coordinate system should be used or whether the xyz-system should be used. However, it would not be terribly difficult to write a “smart file reader” that parses coordinate files a bit more intelligently.

`\pgfplotfunction{variable}{sample list}{point}`

This command will produce coordinates by iterating the *variable* over all values in *sample list*, which should be a list in the `\foreach` syntax. For each value of *variable*, the *point* is evaluated and the resulting coordinate is inserted into the plot stream.

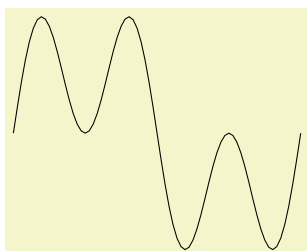

```
\begin{tikzpicture}[x=3.8cm/360]
\pgfplotohandlerlineto
\pgfplotfunction{\x}{0,5,...,360}{\pgfpointxy{\x}{sin(\x)+sin(3*\x)}}
\pgfusepath{stroke}
\end{tikzpicture}
```

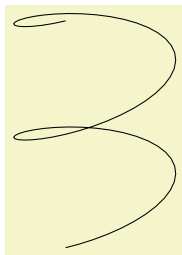

```
\begin{tikzpicture}[y=3cm/360]
  \pgfplothandlerlineto
  \pgfplotfunction{\y}{0,5,...,360}{\pgfpointxyz{sin(2*\y)}{\y}{cos(2*\y)}}
  \pgfusepath{stroke}
\end{tikzpicture}
```

Be warned that if the expressions that need to be evaluated for each point are complex, then this command can be very slow.

`\pgfplotgnuplot` [*prefix*] {*function*}

This command will “try” to call the GNUPLOT program to generate the coordinates of the *function*. In detail, the following happens:

This command works with two files: *prefix*.gnuplot and *prefix*.table. If the optional argument *prefix* is not given, it is set to `\jobname`.

Let us start with the situation where none of these files exists. Then PGF will first generate the file *prefix*.gnuplot. In this file it writes

```
set terminal table; set output "#1.table"; set format "%.5f"
```

where #1 is replaced by *prefix*. Then, in a second line, it writes the text *function*.

Next, PGF will try to invoke the program `gnuplot` with the argument *prefix*.gnuplot. This call may or may not succeed, depending on whether the `\write18` mechanism (also known as shell escape) is switched on and whether the `gnuplot` program is available.

Assuming that the call succeeded, the next step is to invoke `\pgfplotxyfile` on the file *prefix*.table; which is exactly the file that has just been created by `gnuplot`.

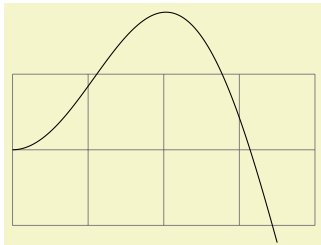

```
\begin{tikzpicture}
  \draw[help lines] (0,-1) grid (4,1);
  \pgfplothandlerlineto
  \pgfplotgnuplot[plots/pgfplotgnuplot-example]{plot [x=0:3.5] x*sin(x)}
  \pgfusepath{stroke}
\end{tikzpicture}
```

The more difficult situation arises when the `.gnuplot` file exists, which will be the case on the second run of `TEX` on the `TEX` file. In this case PGF will read this file and check whether it contains exactly what PGF “would have written” into this file. If this is not the case, the file contents is overwritten with what “should be there” and, as above, `gnuplot` is invoked to generate a new `.table` file. However, if the file contents is “as expected,” the external `gnuplot` program is *not* called. Instead, the *prefix*.table file is immediately read.

As explained in Section 19.6, the net effect of the above mechanism is that `gnuplot` is called as little as possible and that when you pass along the `.gnuplot` and `.table` files with your `.tex` file to someone else, that person can `TEX` the `.tex` file without having `gnuplot` installed and without having the `\write18` mechanism switched on.

### 81.3 Plot Handlers

A *plot handler* prescribes what “should be done” with a plot stream. You must set the plot handler before the stream starts. The following commands install the most basic plot handlers; more plot handlers are defined in the file `pgflibraryplohandlers`, which is documented in Section 42.

All plot handlers work by setting/redefining the following three macros: `\pgf@plotstreamstart`, `\pgf@plotstreampoint`, and `\pgf@plotstreamend`.

`\pgfplothandlerlineto`

This handler will issue a `\pgfpathlineto` command for each point of the plot, *except* possibly for the first. What happens with the first point can be specified using the two commands described below.

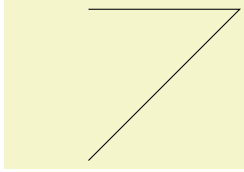

```
\begin{pgfpicture}
  \pgfpathmoveto{\pgfpointorigin}
  \pgfplotstreamstart
  \pgfplotstreampoint{\pgfpoint{1cm}{0cm}}
  \pgfplotstreampoint{\pgfpoint{2cm}{1cm}}
  \pgfplotstreampoint{\pgfpoint{3cm}{2cm}}
  \pgfplotstreampoint{\pgfpoint{1cm}{2cm}}
  \pgfplotstreamend
  \pgfusepath{stroke}
\end{pgfpicture}
```

### `\pgfsetmovetofirstplotpoint`

Specifies that the line-to plot handler (and also some other plot handlers) should issue a move-to command for the first point of the plot instead of a line-to. This will start a new part of the current path, which is not always, but often, desirable. This is the default.

### `\pgfsetlinetofirstplotpoint`

Specifies that plot handlers should issue a line-to command for the first point of the plot.

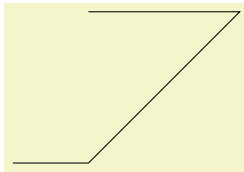

```
\begin{pgfpicture}
  \pgfpathmoveto{\pgfpointorigin}
  \pgfsetlinetofirstplotpoint
  \pgfplotstreamstart
  \pgfplotstreampoint{\pgfpoint{1cm}{0cm}}
  \pgfplotstreampoint{\pgfpoint{2cm}{1cm}}
  \pgfplotstreampoint{\pgfpoint{3cm}{2cm}}
  \pgfplotstreampoint{\pgfpoint{1cm}{2cm}}
  \pgfplotstreamend
  \pgfusepath{stroke}
\end{pgfpicture}
```

### `\pgfplothandlerdiscard`

This handler will simply throw away the stream.

### `\pgfplothandlerrecord{<macro>}`

When this handler is installed, each time a plot stream command is called, this command will be appended to `<macro>`. Thus, at the end of the stream, `<macro>` will contain all the commands that were issued on the stream. You can then install another handler and invoke `<macro>` to “replay” the stream (possibly many times).

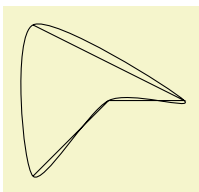

```
\begin{pgfpicture}
  \pgfplothandlerrecord{\mystream}
  \pgfplotstreamstart
  \pgfplotstreampoint{\pgfpoint{1cm}{0cm}}
  \pgfplotstreampoint{\pgfpoint{2cm}{1cm}}
  \pgfplotstreampoint{\pgfpoint{3cm}{1cm}}
  \pgfplotstreampoint{\pgfpoint{1cm}{2cm}}
  \pgfplotstreamend
  \pgfplothandlerlineto
  \mystream
  \pgfplothandlerclosedcurve
  \mystream
  \pgfusepath{stroke}
\end{pgfpicture}
```

## 82 Layered Graphics

### 82.1 Overview

PGF provides a layering mechanism for composing graphics from multiple layers. (This mechanism is not be confused with the conceptual “software layers” the PGF system is composed of.) Layers are often used in graphic programs. The idea is that you can draw on the different layers in any order. So you might start drawing something on the “background” layer, then something on the “foreground” layer, then something on the “middle” layer, and then something on the background layer once more, and so on. At the end, no matter in which ordering you drew on the different layers, the layers are “stacked on top of each other” in a fixed ordering to produce the final picture. Thus, anything drawn on the middle layer would come on top of everything of the background layer.

Normally, you do not need to use different layers since you will have little trouble “ordering” your graphic commands in such a way that layers are superfluous. However, in certain situations you only “know” what you should draw behind something else after the “something else” has been drawn.

For example, suppose you wish to draw a yellow background behind your picture. The background should be as large as the bounding box of the picture, plus a little border. If you know the size of the bounding box of the picture at its beginning, this is easy to accomplish. However, in general this is not the case and you need to create a “background” layer in addition to the standard “main” layer. Then, at the end of the picture, when the bounding box has been established, you can add a rectangle of the appropriate size to the picture.

### 82.2 Declaring Layers

In PGF layers are referenced using names. The standard layer, which is a bit special in certain ways, is called `main`. If nothing else is specified, all graphic commands are added to the `main` layer. You can declare a new layer using the following command:

```
\pgfdeclarelayer{<name>}
```

This command declares a layer named `<name>` for later use. Mainly, this will setup some internal bookkeeping.

The next step toward using a layer is to tell PGF which layers will be part of the actual picture and which will be their ordering. Thus, it is possible to have more layers declared than are actually used.

```
\pgfsetlayers{<layer list>}
```

This command, which should be used *outside* a `{pgfpicture}` environment, tells PGF which layers will be used in pictures. They are stacked on top of each other in the order given. The layer `main` should always be part of the list. Here is an example:

```
\pgfdeclarelayer{background}
\pgfdeclarelayer{foreground}
\pgfsetlayers{background,main,foreground}
```

### 82.3 Using Layers

Once the layers of your picture have been declared, you can start to “fill” them. As said before, all graphics commands are normally added to the `main` layer. Using the `{pgfonlayer}` environment, you can tell PGF that certain commands should, instead, be added to the given layer.

```
\begin{pgfonlayer}{<layer name>}
  <environment contents>
\end{pgfonlayer}
```

The whole `<environment contents>` is added to the layer with the name `<layer name>`. This environment can be used anywhere inside a picture. Thus, even if it is used inside a `{pgfscope}` or a `TeX` group, the contents will still be added to the “whole” picture. Using this environment multiple times inside the same picture will cause the `<environment contents>` to accumulate.

*Note:* You can *not* add anything to the `main` layer using this environment. The only way to add anything to the main layer is to give graphic commands outside all `{pgfonlayer}` environments.



```

\pgfdeclarelayer{background layer}
\pgfdeclarelayer{foreground layer}
\pgfsetlayers{background layer,main,foreground layer}
\begin{tikzpicture}
% On main layer:
\fill[blue] (0,0) circle (1cm);

\begin{pgfonlayer}{background layer}
\fill[yellow] (-1,-1) rectangle (1,1);
\end{pgfonlayer}

\begin{pgfonlayer}{foreground layer}
\node[white] {foreground};
\end{pgfonlayer}

\begin{pgfonlayer}{background layer}
\fill[black] (-.8,-.8) rectangle (.8,.8);
\end{pgfonlayer}

% On main layer again:
\fill[blue!50] (-.5,-1) rectangle (.5,1);
\end{tikzpicture}

```

**\pgfonlayer**{*<layer name>*}

*<environment contents>*

**\endpgfonlayer**

This is the plain T<sub>E</sub>X version of the environment.

**\startpgfonlayer**{*<layer name>*}

*<environment contents>*

**\stoppgfonlayer**

This is the ConT<sub>E</sub>Xt version of the environment.

## 83 Shadings

### 83.1 Overview

A shading is an area in which the color changes smoothly between different colors. Similarly to an image, a shading must first be declared before it can be used. Also similarly to an image, a shading is put into a  $\TeX$ -box. Hence, in order to include a shading in a `{pgfpicture}`, you have to use `\pgftext` around it.

There are different kinds of shadings: horizontal, vertical, radial, and functional shadings. However, you can rotate and clip shadings like any other graphics object, which allows you to create more complicated shadings. Horizontal shadings could be created by rotating a vertical shading by 90 degrees, but explicit commands for creating both horizontal and vertical shadings are included for convenience.

Once you have declared a shading, you can insert it into text using the command `\pgfuseshading`. This command cannot be used directly in a `{pgfpicture}`, you have to put a `\pgftext` around it. The second command for using shadings, `\pgfshadepath`, on the other hand, can only be used inside `{pgfpicture}` environments. It will “fill” the current path with the shading.

A horizontal shading is a horizontal bar of a certain height whose color changes smoothly. You must at least specify the colors at the left and at the right end of the bar, but you can also add color specifications for points in between. For example, suppose you wish to create a bar that is red at the left end, green in the middle, and blue at the end. Suppose you would like the bar to be 4cm long. This could be specified as follows:

```
rgb(0cm)=(1,0,0); rgb(2cm)=(0,1,0); rgb(4cm)=(0,0,1)
```

This line means that at 0cm (the left end) of the bar, the color should be red, which has red-green-blue (rgb) components (1,0,0). At 2cm, the bar should be green, and at 4cm it should be blue. Instead of `rgb`, you can currently also specify `gray` as color model, in which case only one value is needed, or `color`, in which case you must provide the name of a color in parentheses. In a color specification the individual specifications must be separated using a semicolon, which may be followed by a whitespace (like a space or a newline). Individual specifications must be given in increasing order.

### 83.2 Declaring Shadings

#### 83.2.1 Horizontal and Vertical Shadings

```
\pgfdeclarehorizontalshading [⟨color list⟩] {⟨shading name⟩} {⟨shading height⟩} {⟨color specification⟩}
```

Declares a horizontal shading named *⟨shading name⟩* of the specified *⟨height⟩* with the specified colors. The length of the bar is deduced automatically from the maximum dimension in the specification.



```
\pgfdeclarehorizontalshading{myshadingA}
{1cm}{rgb(0cm)=(1,0,0); color(2cm)=(green); color(4cm)=(blue)}
\pgfuseshading{myshadingA}
```

The effect of the *⟨color list⟩*, which is a comma-separated list of colors, is the following: Normally, when this list is empty, once a shading has been declared, it becomes “frozen.” This means that even if you change a color that was used in the declaration of the shading later on, the shading will not change. By specifying a *⟨color list⟩* you can specify that the shading should be recalculated whenever one of the colors listed in the list changes (this includes effects like color mixins). Thus, when you specify a *⟨color list⟩*, whenever the shading is used, PGF first converts the colors in the list to RGB triples using the current values of the colors and taking any mixins and blends into account. If the resulting RGB triples have not yet been used, a new shading is internally created and used. Note that if the option *⟨color list⟩* is used, then no shading is created until the first use of `\pgfuseshading`. In particular, the colors mentioned in the shading need not be defined when the declaration is given.

When a shading is recalculated because of a change in the colors mentioned in *⟨color list⟩*, the complete shading is recalculated. Thus even colors not mentioned in the list will be used with their current values, not with the values they had upon declaration.



```
\pgfdeclarehorizontalshading[mycolor]{myshadingB}
{1cm}{rgb(0cm)=(1,0,0); color(2cm)=(mycolor)}
\colorlet{mycolor}{green}
\pgfuseshading{myshadingB}
\colorlet{mycolor}{blue}
\pgfuseshading{myshadingB}
```

`\pgfdeclareverticalshading`[*⟨color list⟩*]{*⟨shading name⟩*}{*⟨shading width⟩*}{*⟨color specification⟩*}

Declares a vertical shading named *⟨shading name⟩* of the specified *⟨width⟩*. The height of the bar is deduced automatically. The effect of *⟨color list⟩* is the same as for horizontal shadings.

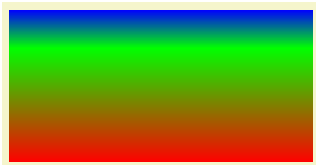

```
\pgfdeclareverticalshading{myshadingC}
{4cm}{rgb(0cm)=(1,0,0); rgb(1.5cm)=(0,1,0); rgb(2cm)=(0,0,1)}
\pgfuses shading{myshadingC}
```

### 83.2.2 Radial Shadings

`\pgfdeclareradialshading`[*⟨color list⟩*]{*⟨shading name⟩*}{*⟨center point⟩*}{*⟨color specification⟩*}

Declares an radial shading. A radial shading is a circle whose inner color changes as specified by the color specification. Assuming that the center of the shading is at the origin, the color of the center will be the color specified for 0cm and the color of the border of the circle will be the color for the maximum dimension given in the *⟨color specified⟩*. This maximum will also be the radius of the circle. If the *⟨center point⟩* is not at the origin, the whole shading inside the circle (whose size remains exactly the same) will be distorted such that the given center now has the color specified for 0cm. The effect of *⟨color list⟩* is the same as for horizontal shadings.

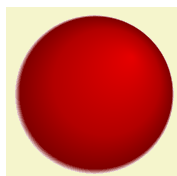

```
\pgfdeclareradialshading{sphere}{\pgfpoint{0.5cm}{0.5cm}}%
{rgb(0cm)=(0.9,0,0);
rgb(0.7cm)=(0.7,0,0);
rgb(1cm)=(0.5,0,0);
rgb(1.05cm)=(1,1,1)}
\pgfuses shading{sphere}
```

### 83.2.3 General (Functional) Shadings

`\pgfdeclarefunctionalshading`[*⟨color list⟩*]{*⟨shading name⟩*}{*⟨lower left corner⟩*}{*⟨upper right corner⟩*}{*⟨init code⟩*}{*⟨type 4 function⟩*}

*Warning: These shadings are the least portable of all and they put the heaviest burden of the renderer. They are slow and, possibly, will not print correctly!*

This command creates a *functional shading*. For such a shading, the color of each point is calculated by calling a function that gets the coordinates of the point as input and yields the color as an output. Note that the function is evaluated by the *renderer*, not by PGF or TeX or someone else at compile-time. This means that the evaluation of this function has to be done *extremely quickly* and the function should be *very simple*. For this reason, only a very restricted set of operations are possible in the function and functions should be kept small. Any errors in the function will only be noticed by the renderer.

The syntax for specifying functions is the following: You use a simplified form of a subset of the PostScript language. This subset will be understood by the PDF-renderer (yes, PDF-renderers do have a basic understanding of PostScript) and also by PostScript renders. This subset is detailed in Section 3.9.4 of the PDF-specification (version 1.7). In essence, the specification states that these functions may contain “expressions involving integers, real numbers, and boolean values only. There are no composite data structures such as strings or arrays, no procedures, and no variables or names.” The allowed operators are (exactly) the following: `abs`, `add`, `atan`, `ceiling`, `cos`, `cvi`, `cvr`, `div`, `exp`, `floor`, `idiv`, `ln`, `log`, `mod`, `mul`, `neg`, `round`, `sin`, `sqrt`, `sub`, `truncate`, `and`, `bitshift`, `eq`, `false`, `ge`, `gt`, `le`, `lt`, `ne`, `not`, `or`, `true`, `xor`, `if`, `ifelse`, `copy`, `dup`, `exch`, `index`, `pop`.

When the function is evaluated, the top two stack elements are the coordinates of the point for which the color should be computed. The coordinates are dimensionless and given in big points, so for the coordinate (50bp, 72.27pt) the top two stack elements would be 50.0 and 72.0. Otherwise, the (virtual) stack is empty (or should be treated as if it were empty). The function should then replace these two values by three values, representing the red, green, and blue color of the point. The numbers should be real values, not integers since Apple’s PDF renderer is broken in this regard (use `cvr` at the end if necessary).



Conceptually, the function will be evaluated once for each point of the rectangle  $\langle lower\ left\ corner \rangle$  to  $\langle upper\ right\ corner \rangle$ , which should be a PGF-point expression like `\pgfpoint{100bp}{100bp}`. A renderer may choose to evaluate the function at less points, but, in principle, the function will be evaluated for each pixel independently.

Because of the rather difficult PostScript syntax, use this macro only *if you know what you are doing* (or if you are advanterous, of course).

As for other shadings, the optional  $\langle color\ list \rangle$  is used to determine whether a shading needs to be recalculated when a color has changed.

The  $\langle init\ code \rangle$  is executed each time a shading is (re)calculated. Typically, it will contain code to extract coordinates from colors.



```
\pgfdeclarefunctionalshading{twospots}
  {\pgfpointorigin}{\pgfpoint{4cm}{4cm}}{}{
  % Save coordinates for later
  2 copy
  % Compute distance from (40bp,45bp), with x doubled
  45 sub dup mul exch
  40 sub dup mul 0.5 mul add sqrt
  % exponential decay
  dup mul neg 1.0005 exch exp 1.0 exch sub
  % Compute distance from (70bp,70bp) from stored coordiante, scaled
  3 1 roll
  70 sub dup mul .5 mul exch
  70 sub dup mul add sqrt
  % Decay
  dup mul neg 1.002 exch exp 1.0 exch sub
  % red component
  1.0 3 1 roll
  }
\pgfuseshading{twospots}
```

Inside the PostScript function  $\langle type\ 4\ function \rangle$  you cannot use colors directly. Rather, you must push the color components on the stack. For this, it is useful to call `\pgfshadecolorrrgb` in the  $\langle init\ code \rangle$ :

`\pgfshadecolortorgb{ $\langle color\ name \rangle$ }{ $\langle macro \rangle$ }`

This command takes  $\langle color\ name \rangle$  as input and stores the color's red/green/blue components real numbers between 0.0 and 1.0 separated by spaces (which is exactly what you need if you want to push it on a stack) in  $\langle macro \rangle$ . This macro can then be used inside the  $\langle type\ 4\ function \rangle$  argument for `\pgfdeclarefunctionalshading`.



```
\pgfdeclarefunctionalshading[mycol]{sweep}{\pgfpoint{-1cm}{-1cm}}
{\pgfpoint{1cm}{1cm}}{\pgfshadecolortorgb{mycol}{\myrgb}}{
  2 copy          % whirl
  % Calculate "safe" atan of position
  2 copy abs exch add 0.0001 ge { atan } { pop } ifelse
  3 1 roll
  dup mul exch
  dup mul add sqrt
  30 mul
  add
  sin
  1 add 2 div
  dup
  \myrgb          % push mycol
  5 4 roll        % multiply all components by calculated value
  mul
  3 1 roll
  3 index
  mul
  3 1 roll
  4 3 roll
  mul
  3 1 roll
}
\colorlet{mycol}{white}%
\pgfuseshading{sweep}%
\colorlet{mycol}{red}%
\pgfuseshading{sweep}
```

In addition, three macros suffixed with `red`, `green` and `blue` are defined, which store the individual components of  $\langle color\ name \rangle$ . These can also be used in the  $\langle type\ 4\ function \rangle$  argument.

```
\mycol=1.0 0.5 0.0 \mycolred=1.0 \mycolgreen=0.5 \mycolblue=0.0
```

```
\pgfshadecolor{orange}{\mycol}
|\mycol|=\mycol |\mycolred|=\mycolred |\mycolgreen|=\mycolgreen |\mycolblue|=\mycolblue
```

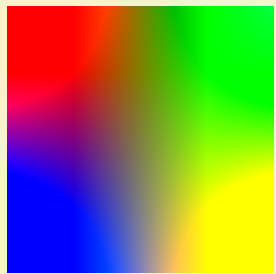

```
\pgfdeclarefunctionalshading[col1,col2,col3,col4]{bilinear interpolation}
{\pgfpointorigin}{\pgfpoint{100bp}{100bp}}
{
  \pgfshadecolor{col1}{\first}\pgfshadecolor{col2}{\second}
  \pgfshadecolor{col3}{\third}\pgfshadecolor{col4}{\fourth}
}{
  100 div exch 100 div 2 copy           % Calculate y/100 x/100.
  neg 1 add exch neg 1 add             % Calculate 1-y/100 1-x/100.
  3 1 roll 2 copy exch 5 2 roll 6 copy 6 copy % Set up stack.
  \firstred mul exch \secondred mul add mul % Process red component.
  4 1 roll
  \thirdred mul exch \fourthred mul add mul
  add
  13 1 roll
  \firstgreen mul exch \secondgreen mul add mul % Process green component.
  4 1 roll
  \thirdgreen mul exch \fourthgreen mul add mul
  add
  7 1 roll
  \firstblue mul exch \secondblue mul add mul % Process blue component.
  4 1 roll
  \thirdblue mul exch \fourthblue mul add mul
  add
}

\colorlet{col1}{blue}
\colorlet{col2}{yellow}
\colorlet{col3}{red}
\colorlet{col4}{green}
\pgfuses shading{bilinear interpolation}
```

### 83.3 Using Shadings

`\pgfuses shading`{ $\langle shading\ name \rangle$ }

Inserts a previously declared shading into the text. If you wish to use it in a `pgfpicture` environment, you should put a `\pgfbox` around it.

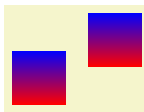

```
\begin{pgfpicture}
  \pgfdeclareverticalshading{myshadingD}
  {20pt}{color(0pt)=(red); color(20pt)=(blue)}
  \pgftext[at=\pgfpoint{1cm}{0cm}] {\pgfuses shading{myshadingD}}
  \pgftext[at=\pgfpoint{2cm}{0.5cm}]{\pgfuses shading{myshadingD}}
\end{pgfpicture}
```

`\pgfshadepath`{ $\langle shading\ name \rangle$ }{ $\langle angle \rangle$ }

This command must be used inside a `pgfpicture` environment. The effect is a bit complex, so let us go over it step by step.

First, PGF will setup a local scope.

Second, it uses the current path to clip everything inside this scope. However, the current path is once more available after the scope, so it can be used, for example, to stroke it.

Now, the  $\langle shading\ name \rangle$  should be a shading whose width and height are 100 bp, that is, 100 big points. PGF has a look at the bounding box of the current path. This bounding box is computed automatically when a path is computed; however, it can sometimes be (quite a bit) too large, especially when complicated curves are involved.

Inside the scope, the low-level transformation matrix is modified. The center of the shading is translated (moved) such that it lies on the center of the bounding box of the path. The low-level coordinate system is also scaled such that the shading “covers” the shading (the details are a bit more

complex, see below). Then, the coordinate system is rotated by  $\langle angle \rangle$ . Finally, if the macro `\pgfsetadditionalshadetransform` has been used, an additional transformation is applied.

After everything has been set up, the shading is inserted. Due to the transformations and clippings, the effect will be that the shading seems to “fill” the path.

If both the path and the shadings were always rectangles and if rotation were never involved, it would be easy to scale shadings such they always cover the path. However, when a vertical shading is rotated, it must obviously be “magnified” so that it still covers the path. Things get worse when the path is not a rectangle itself.

For these reasons, things work slightly differently “in reality.” The shading is scaled and translated such that the the point (50bp,50bp), which is the middle of the shading, is at the middle of the path and such that the the point (25bp,25bp) is at the lower left corner of the path and that (75bp,75bp) is at upper right corner.

In other words, only the center quarter of the shading will actually “survive the clipping” if the path is a rectangle. If the path is not a rectangle, but, say, a circle, even less is seen of the shading. Here is an example that demonstrates this effect:

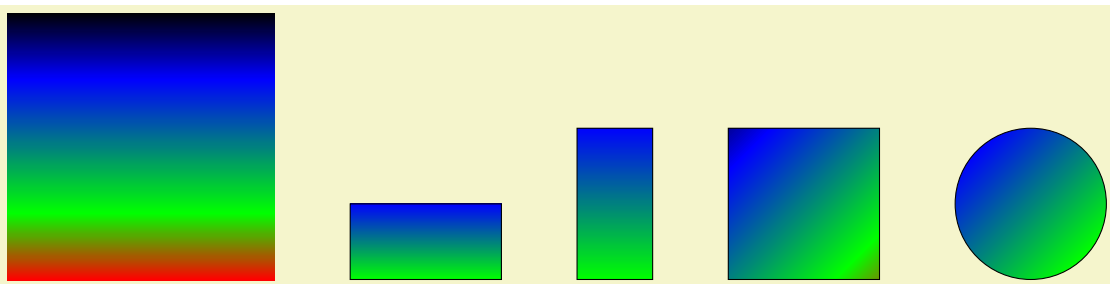

```
\pgfdeclareverticalshading{myshadingE}{100bp}
{color(0bp)=(red); color(25bp)=(green); color(75bp)=(blue); color(100bp)=(black)}
\pgfuses shading{myshadingE}
\hskip 1cm
\begin{pgfpicture}
\pgfpathrectangle{\pgfpointorigin}{\pgfpoint{2cm}{1cm}}
\pgfshadepath{myshadingE}{0}
\pgfusepath{stroke}
\pgfpathrectangle{\pgfpoint{3cm}{0cm}}{\pgfpoint{1cm}{2cm}}
\pgfshadepath{myshadingE}{0}
\pgfusepath{stroke}
\pgfpathrectangle{\pgfpoint{5cm}{0cm}}{\pgfpoint{2cm}{2cm}}
\pgfshadepath{myshadingE}{45}
\pgfusepath{stroke}
\pgfpathcircle{\pgfpoint{9cm}{1cm}}{1cm}
\pgfshadepath{myshadingE}{45}
\pgfusepath{stroke}
\end{pgfpicture}
```

As can be seen above in the last case, the “hidden” part of the shading actually *can* become visible if the shading is rotated. The reason is that it is scaled as if no rotation took place, then the rotation is done.

The following graphics show which part of the shading are actually shown:

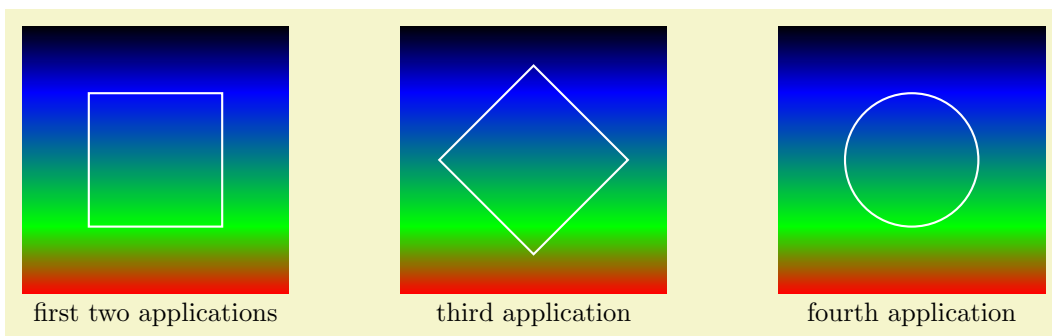

```

\pgfdeclareverticalshading{myshadingF}{100bp}
{color(0bp)=(red); color(25bp)=(green); color(75bp)=(blue); color(100bp)=(black)}
\begin{tikzpicture}
\draw (50bp,50bp) node {\pgfuses shading{myshadingF}};
\draw[white,thick] (25bp,25bp) rectangle (75bp,75bp);
\draw (50bp,0bp) node[below] {first two applications};

\begin{scope}[xshift=5cm]
\draw (50bp,50bp) node{\pgfuses shading{myshadingF}};
\draw[rotate around={45:(50bp,50bp)},white,thick] (25bp,25bp) rectangle (75bp,75bp);
\draw (50bp,0bp) node[below] {third application};
\end{scope}

\begin{scope}[xshift=10cm]
\draw (50bp,50bp) node{\pgfuses shading{myshadingF}};
\draw[white,thick] (50bp,50bp) circle (25bp);
\draw (50bp,0bp) node[below] {fourth application};
\end{scope}
\end{tikzpicture}

```

An advantage of this approach is that when you rotate a radial shading, no distortion is introduced:

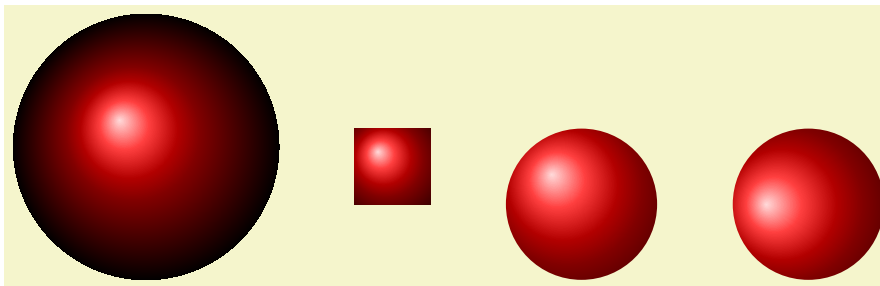

```

\pgfdeclareradialshading{ballshading}{\pgfpoint{-10bp}{10bp}}
{color(0bp)=(red!15!white); color(9bp)=(red!75!white);
color(18bp)=(red!70!black); color(25bp)=(red!50!black); color(50bp)=(black)}
\pgfuses shading{ballshading}
\hspace 1cm
\begin{pgfpicture}
\pgfpathrectangle{\pgfpointorigin}{\pgfpoint{1cm}{1cm}}
\pgfshadepath{ballshading}{0}
\pgfusepath{}
\pgfpathcircle{\pgfpoint{3cm}{0cm}}{1cm}
\pgfshadepath{ballshading}{0}
\pgfusepath{}
\pgfpathcircle{\pgfpoint{6cm}{0cm}}{1cm}
\pgfshadepath{ballshading}{45}
\pgfusepath{}
\end{pgfpicture}

```

If you specify a rotation of 90° and if the path is not a square, but an elongated rectangle, the “desired” effect results: The shading will exactly vary between the colors at the 25bp and 75bp boundaries. Here is an example:



```

\pgfdeclareverticalshading{myshadingG}{100bp}
{color(0bp)=(red); color(25bp)=(green); color(75bp)=(blue); color(100bp)=(black)}
\begin{pgfpicture}
\pgfpathrectangle{\pgfpointorigin}{\pgfpoint{2cm}{1cm}}
\pgfshadepath{myshadingG}{0}
\pgfusepath{stroke}
\pgfpathrectangle{\pgfpoint{3cm}{0cm}}{\pgfpoint{2cm}{1cm}}
\pgfshadepath{myshadingG}{90}
\pgfusepath{stroke}
\pgfpathrectangle{\pgfpoint{6cm}{0cm}}{\pgfpoint{2cm}{1cm}}
\pgfshadepath{myshadingG}{45}
\pgfusepath{stroke}
\end{pgfpicture}

```

As a final example, let us define a “rainbow spectrum” shading for use with TikZ.



```
\pgfdeclareverticalshading{rainbow}{100bp}
{color(0bp)=(red); color(25bp)=(red); color(35bp)=(yellow);
color(45bp)=(green); color(55bp)=(cyan); color(65bp)=(blue);
color(75bp)=(violet); color(100bp)=(violet)}
\begin{tikzpicture}[shading=rainbow]
\shade (0,0) rectangle node[white] {\textsc{pride}} (2,1);
\shade[shading angle=90] (3,0) rectangle +(1,2);
\end{tikzpicture}
```

Note that rainbow shadings are *way* to colorful in almost all applications.

`\pgfsetadditionalshadetransform`{*(transformation)*}

This command allows you to specify an additional transformation that should be applied to shadings when the `\pgfshadepath` command is used. The *(transformation)* should be transformation code like `\pgftransformrotate{20}`.

## 84 Transparency

For an introduction to the notion of transparency, fadings, and transparency groups, please consult Section 20.

### 84.1 Specifying a Uniform Opacity

Specifying a stroke and/or fill opacity is quite easy.

#### `\pgfsetstrokeopacity{⟨value⟩}`

Sets the opacity of stroking operations. The  $\langle value \rangle$  should be a number between 0 and 1, where 1 means “fully opaque” and 0 means “fully transparent.” A value like 0.5 will cause paths to be stroked in a semitransparent way.

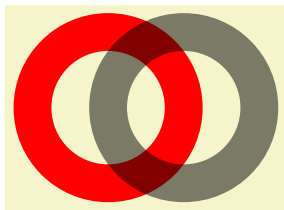

```
\begin{pgfpicture}
\pgfsetlinewidth{5mm}
\color{red}
\pgfpathcircle{\pgfpoint{0cm}{0cm}}{10mm} \pgfusepath{stroke}
\color{black}
\pgfsetstrokeopacity{0.5}
\pgfpathcircle{\pgfpoint{1cm}{0cm}}{10mm} \pgfusepath{stroke}
\end{pgfpicture}
```

#### `\pgfsetfillopacity{⟨value⟩}`

Sets the opacity of filling operations. As for stroking, the  $\langle value \rangle$  should be a number between 0 and 1. The “filling transparency” will also be used for text and images.

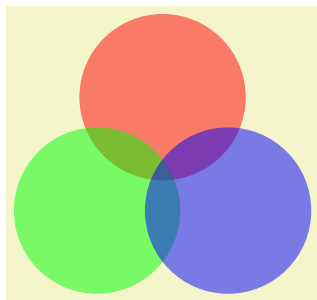

```
\begin{tikzpicture}
\pgfsetfillopacity{0.5}
\fill[red] (90:1cm) circle (11mm);
\fill[green] (210:1cm) circle (11mm);
\fill[blue] (-30:1cm) circle (11mm);
\end{tikzpicture}
```

Note the following effect: If you setup a certain opacity for stroking or filling and you stroke or fill the same area twice, the effect accumulates:

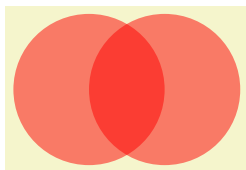

```
\begin{tikzpicture}
\pgfsetfillopacity{0.5}
\fill[red] (0,0) circle (1);
\fill[red] (1,0) circle (1);
\end{tikzpicture}
```

Often, this is exactly what you intend, but not always. You can use transparency groups, see the end of this section, to change this.

### 84.2 Specifying a Fading

The method used by PGF for specifying fadings is quite general: You “paint” the fading using any of the standard graphics commands. In more detail: You create a normal picture, which may even contain text, image, and shadings. Then, you create a fading based on this picture. For this, the *luminosity* of each pixel of the picture is analysed (the brighter the pixel, the higher the luminosity – a black pixel has luminosity 0, a white pixel has luminosity 1, a gray pixel has some intermediate value as does a red pixel). Then, when the fading is used, the luminosity of the pixel determines the opacity of the fading at that position. Positions in the fading where the picture was black will be completely transparent, positions where the picture was white will be completely opaque. Positions that have not been painted at all in the picture are always completely transparent.

`\pgfdeclarefading{<name>}{<contents>}`

This command declare a fading named `<name>` for later use. The “picture” on which the fading is based is given by the `<contents>`. This `<contents>` is normally typeset in a  $\TeX$  box. The resulting box is then used as the “picture.” In particular, inside the `<contents>` you must explicitly open a `{pgfpicture}` environment if you wish to use PGF commands.

Let’s start with an easy example. Our first fading picture is just some text:



```
\pgfdeclarefading{fading1}{\color{white}Ti\emph{k}Z}
\begin{tikzpicture}
  \fill [black!20] (0,0) rectangle (2,2);
  \fill [black!30] (0,0) arc (180:0:1);
  \pgfsetfading{fading1}{\pgftransformshift{\pgfpoint{1cm}{1cm}}}
  \fill [red] (0,0) rectangle (2,2);
\end{tikzpicture}
```

What’s happening here? The “fading picture” is mostly transparent, except for the pixels that are part of the word *Ti&kZ*. Now, these pixels are *white* and, thus, have a high luminosity. This in turn means that these pixels of the fading will be highly opaque. For this reason, only those pixels of the big red rectangle “shine through” that are at the positions of these opaque pixels.

It is somewhat counter-intuitive that the white pixels in a fading picture are opaque in a fading. For this reason, the color `pgftransparent` is defined to be the same as `black`. This allows one to write `pgftransparent` for completely transparent parts of a fading picture and `pgftransparent!0` for the opaque parts and things liek `pgftransparent!20` for parts that are 20% transparent.

Furthermore, the color `pgftransparent!0` (which is the same as white and which corresponds to completely opaque) is installed at the beginning of a fading picture. Thus, in the above example the `\color{white}` was not really necessary.

Next, let us create a fading that gets more and more transparent as we go from left to right. For this, we put a shading inside the fading picture that has the color `pgftransparent!0` at the left-hand side and the color `pgftransparent!100` at the right-hand side.

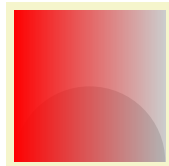

```
\pgfdeclarefading{fading2}
{\tikz \shade[left color=pgftransparent!0,
              right color=pgftransparent!100] (0,0) rectangle (2,2);}
\begin{tikzpicture}
  \fill [black!20] (0,0) rectangle (2,2);
  \fill [black!30] (0,0) arc (180:0:1);
  \pgfsetfading{fading2}{\pgftransformshift{\pgfpoint{1cm}{1cm}}}
  \fill [red] (0,0) rectangle (2,2);
\end{tikzpicture}
```

In our final example, we create a fading that is based on a radial shading.

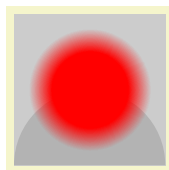

```
\pgfdeclareradialshading{myshading}{\pgfpointorigin}
{
  color(0mm)=(pgftransparent!0);
  color(5mm)=(pgftransparent!0);
  color(8mm)=(pgftransparent!100);
  color(15mm)=(pgftransparent!100)
}
\pgfdeclarefading{fading3}{\pgfuses shading{myshading}}
\begin{tikzpicture}
  \fill [black!20] (0,0) rectangle (2,2);
  \fill [black!30] (0,0) arc (180:0:1);
  \pgfsetfading{fading3}{\pgftransformshift{\pgfpoint{1cm}{1cm}}}
  \fill [red] (0,0) rectangle (2,2);
\end{tikzpicture}
```

After having declared a fading, we can use it. As for shadings, there are two different commands for using fadings:

`\pgfsetfading{<name>}{<transformations>}`

This command sets the graphic state parameter “fading” to a previously defined fading `<name>`. This graphic state works like other graphic states, that is, is persists till the end of the current scope or until a different transparency setting is chosen.

When the fading is installed, it will be centered on the origin with its natural size. Anything outside the fading pictures's original bounding box will be transparent and, thus, the fading effectively clips against this bounding box.

The  $\langle transformations \rangle$  are applied to the fading before it is used. They contain normal PGF transformation commands like `\pgftransformshift`. You can also scale the fading using this command. Note, however, that the transformation needs to be inverted internally, which may result in inaccuracies and the following graphics may be slightly distorted if you use a strong  $\langle transformation \rangle$ .

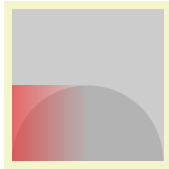

```
\pgfdeclarefading{fading2}
{\tikz \shade[left color=pgftransparent!0,
              right color=pgftransparent!100] (0,0) rectangle (2,2);}
\begin{tikzpicture}
  \fill [black!20] (0,0) rectangle (2,2);
  \fill [black!30] (0,0) arc (180:0:1);
  \pgfsetfading{fading2}{}
  \fill [red] (0,0) rectangle (2,2);
\end{tikzpicture}
```



```
\begin{tikzpicture}
  \fill [black!20] (0,0) rectangle (2,2);
  \fill [black!30] (0,0) arc (180:0:1);
  \pgfsetfading{fading2}{\pgftransformshift{\pgfpoint{1cm}{1cm}}
                    \pgftransformrotate{20}}
  \fill [red] (0,0) rectangle (2,2);
\end{tikzpicture}
```

### `\pgfsetfadingforcurrentpath` $\langle name \rangle$ $\langle transformations \rangle$

This command works like `\pgfsetfading`, but the fading is scaled and transformed according to the following rules:

1. If the current path is empty, the command has the same effect as `\pgfsetfading`.
2. Otherwise it is assumed that the fading has a size of 100bp times 100bp.
3. The fading is resized and shifted (using appropriate transformations) such that the position (25bp, 25bp) lies at the lower-left corner of the current path and the position (75bp, 75bp) lies at the upper-right corner of the current path.

Note that these rules are the same as the ones used in `\pgfshadepath` for shadings. After these transformations, the  $\langle transformations \rangle$  are executed (typically a rotation).

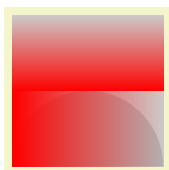

```
\pgfdeclarehorizontalshading{shading}{100bp}
{ color(0pt)=(transparent!0);   color(25bp)=(transparent!0);
  color(75bp)=(transparent!100); color(100bp)=(transparent!100)}
\pgfdeclarefading{fading}{\pgfuseshading{shading}}
\begin{tikzpicture}
  \fill [black!20] (0,0) rectangle (2,2);
  \fill [black!30] (0,0) arc (180:0:1);
  \pgfpathrectangle{\pgfpointorigin}{\pgfpoint{2cm}{1cm}}
  \pgfsetfadingforcurrentpath{fading}{}
  \pgfusepath{discard}
  \fill [red] (0,0) rectangle (2,1);
  \pgfpathrectangle{\pgfpoint{0cm}{1cm}}{\pgfpoint{2cm}{1cm}}
  \pgfsetfadingforcurrentpath{fading}{\pgftransformrotate{90}}
  \pgfusepath{discard}
  \fill [red] (0,1) rectangle (2,2);
\end{tikzpicture}
```

## 84.3 Transparency Groups

Transparency groups are declared using the following commands.



```
\begin{pgftransparencygroup}
  <environment contents>
\end{pgftransparencygroup}
```

This environment should only be used inside a `{pgfpicture}`. It has the following effect:

1. The `<environment contents>` is stroked/filled “ignoring any outside transparency.” This means, all previous transparency settings are ignored (you can still set transparency inside the group, but never mind). This means that if in the `<environment contents>` you stroke a pixel three times in black, it is just black. Stroking it white afterwards yields a white pixel, and so on.
2. When the group is finished, it is painted as a whole. The `fill` transparency settings are now applied to the resulting picture. For instance, the pixel that has been painted three times in black and once in white is just white at the end, so this white color will be blended with whatever is “behind” the group on the page.

Note that, depending on the driver, PGF may have to guess the size of the contents of the transparency group (because such a group is put in an XForm in PDF and a bounding box must be supplied). PGF will normally use the size of the picture’s bounding box at the end of the transparency group plus a safety margin of 1cm. Under normal circumstances, this will work nicely since the picture’s bounding box contains everything anyway. However, if you have switched off the picture size tracking or if you are using canvas transformations, you may have to make sure that the bounding box is big enough. The trick is to locally create a picture that is “large enough” and then insert this picture into the main picture while ignoring the size. The following example shows how this is done:

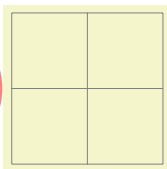

```
\begin{tikzpicture}
  \draw [help lines] (0,0) grid (2,2);

  % Stuff outside the picture, but still in a transparency group.
  \node [left,overlay] at (0,1) {
    \begin{tikzpicture}
      \pgfsetfillopacity{0.5}
      \pgftransparencygroup
      \node at (2,0) [forbidden sign,line width=2ex,draw=red,fill=white]
        {Smoking};
      \endpgftransparencygroup
    \end{tikzpicture}
  };
\end{tikzpicture}
```

```
\pgftransparencygroup
  <environment contents>
```

```
\endpgftransparencygroup
```

Plain T<sub>E</sub>X version of the `{pgftransparencygroup}` environment.

```
\startpgftransparencygroup
  <environment contents>
```

```
\stoppgftransparencygroup
```

This is the ConT<sub>E</sub>Xt version of the environment.

## 85 Adding libraries to pgf: temporary registers

This section is intended for those who like to write libraries to extend PGF. Of course, this requires a good deal of knowledge about T<sub>E</sub>X-programming and the structure of the PGF basic layer. Besides, one will encounter the need of temporary variables and, especially, temporary T<sub>E</sub>X registers. This section describes how to use a set of pre-allocated temporary registers of the basic layer without needing to allocate more of them.

A part of these internals are already mentioned in section 70.7, but the basic layer provides more temporaries than `\pgf@x` and `\pgf@y`.

Internal dimen register `\pgf@x`

Internal dimen register `\pgf@y`

These registers are used to process point coordinates in the basic layer of PGF, see section 70.7. After a `\pgfpoint...` command, they contain the final  $x$  and  $y$  coordinate, respectively.

The values of `\pgf@x` and `\pgf@y` are set *globally* in contrast to other available PGF registers. You should never assume anything about their value unless the context defines them explicitly.

Please prefer the `\pgf@xa`, `\pgf@xb`, ... registers for temporary dimen registers unless you are writing point coordinate commands.

Internal dimen register `\pgf@xa`

Internal dimen register `\pgf@xb`

Internal dimen register `\pgf@xc`

Internal dimen register `\pgf@ya`

Internal dimen register `\pgf@yb`

Internal dimen register `\pgf@yc`

Temporary registers for T<sub>E</sub>X dimensions which can be modified freely. Just make sure changes occur only within T<sub>E</sub>X groups.

**Attention:** PGF uses these registers to perform path operations. For reasons of efficiency, path commands do not always guard them. As a consequence, the code

```
\pgfpointadd{\pgfpoint{\pgf@xa}{\pgf@ya}}{\pgfpoint{\pgf@xb}{\pgf@yb}}
```

may fail: Inside `\pgfpointadd`, the `\pgf@xa` and friend registers might be modified. In particular, it might happen that `\pgf@xb` is changed before `\pgfpoint{\pgf@xb}{\pgf@yb}` is evaluated. The right thing to do would be to first expand everything using `\edef` and process the values afterwards, resulting in unnecessary expensive operations. Of course, one can avoid this by simply looking into the source code of `\pgfpointadd` to see which registers are used.

Internal dimen register `\pgfutil@tempdima`

Internal dimen register `\pgfutil@tempdimb`

Further multi-purpose temporary dimen registers. For L<sup>A</sup>T<sub>E</sub>X, these registers are already allocated as `\@tempdima` and `\@tempdimb` and are simply `\let` to the `\pgfutil@...` names.

Internal count register `\c@pgf@counta`

Internal count register `\c@pgf@countb`

Internal count register `\c@pgf@countc`

Internal count register `\c@pgf@countd`

These multiple-purpose count registers are used throughout PGF to perform integer computations. Feel free to use them as well, just make sure changes are scoped by local T<sub>E</sub>X groups.

Internal openout handle `\w@pgf@writea`

An `\openout` handle which is used to generate complete output files within locally scoped parts of PGF (for example, to interact with `gnuplot`). You should always use `\immediate` in front of output operations involving `\w@pgf@writea` and you should always close the file before returning from your code.

```
\immediate\openout\w@pgf@writea=myfile.dat
\immediate\write\w@pgf@writea{...}%
\immediate\write\w@pgf@writea{...}%
\immediate\closeout\w@pgf@writea%
```

Internal box `\pgfutil@tempboxa`

A box for temporary use inside of local  $\TeX$  scopes. For  $\LaTeX$ , this box is the same as the already pre-allocated `\@tempboxa`.

## 86 Quick Commands

This section explains the “quick” commands of PGF. These commands are executed more quickly than the normal commands of PGF, but offer less functionality. You should use these commands only if you either have a very large number of commands that need to be processed or if you expect your commands to be executed very often.

### 86.1 Quick Coordinate Commands

`\pgfqpoint`{ $\langle x \rangle$ }{ $\langle y \rangle$ }

This command does the same as `\pgfpoint`, but  $\langle x \rangle$  and  $\langle y \rangle$  must be simple dimensions like `1pt` or `1cm`. Things like `2ex` or `2cm+1pt` are not allowed.

`\pgfqpointxy`{ $\langle s_x \rangle$ }{ $\langle s_y \rangle$ }

This command does the same as `\pgfpointxy`, but  $\langle s_x \rangle$  and  $\langle s_y \rangle$  must be simple numbers without unit, like `1.234` or `5.0`. Mathematical expressions or units are not allowed.

`\pgfqpointxyz`{ $\langle s_x \rangle$ }{ $\langle s_y \rangle$ }{ $\langle s_z \rangle$ }

As `\pgfqpointxy`, but for three-dimensional coordinates. Any argument needs to be a number without unit.

### 86.2 Quick Path Construction Commands

The difference between the quick and the normal path commands is that the quick path commands

- do not keep track of the bounding boxes,
- do not allow you to arc corners,
- do not apply coordinate transformations.

However, they do use the soft-path subsystem (see Section 89 for details), which allows you to mix quick and normal path commands arbitrarily.

All quick path construction commands start with `\pgfpathq`.

`\pgfpathqmoveto`{ $\langle x \text{ dimension} \rangle$ }{ $\langle y \text{ dimension} \rangle$ }

Either starts a path or starts a new part of a path at the coordinate  $(\langle x \text{ dimension} \rangle, \langle y \text{ dimension} \rangle)$ . The coordinate is *not* transformed by the current coordinate transformation matrix. However, any low-level transformations apply.

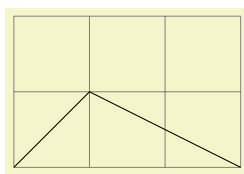

```
\begin{tikzpicture}
\draw[help lines] (0,0) grid (3,2);
\pgftransformxshift{1cm}
\pgfpathqmoveto{0pt}{0pt} % not transformed
\pgfpathqlineto{1cm}{1cm} % not transformed
\pgfpathlineto{\pgfpoint{2cm}{0cm}}
\pgfusepath{stroke}
\end{tikzpicture}
```

`\pgfpathqlineto`{ $\langle x \text{ dimension} \rangle$ }{ $\langle y \text{ dimension} \rangle$ }

The quick version of the line-to operation.

`\pgfpathqcurveto`{ $\langle s_x^1 \rangle$ }{ $\langle s_y^1 \rangle$ }{ $\langle s_x^2 \rangle$ }{ $\langle s_y^2 \rangle$ }{ $\langle t_x \rangle$ }{ $\langle t_y \rangle$ }

The quick version of the curve-to operation. The first support point is  $(s_x^1, s_y^1)$ , the second support point is  $(s_x^2, s_y^2)$ , and the target is  $(t_x, t_y)$ .

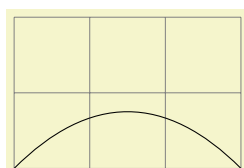

```
\begin{tikzpicture}
\draw[help lines] (0,0) grid (3,2);
\pgfpathqmoveto{0pt}{0pt}
\pgfpathqcurveto{1cm}{1cm}{2cm}{1cm}{3cm}{0cm}
\pgfusepath{stroke}
\end{tikzpicture}
```

`\pgfpathqcircle{⟨radius⟩}`

Adds a radius around the origin of the given  $\langle radius \rangle$ . This command is orders of magnitude faster than `\pgfcircle{\pgfpointorigin}{⟨radius⟩}`.

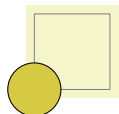

```
\begin{tikzpicture}
  \draw[help lines] (0,0) grid (1,1);
  \pgfpathqcircle{10pt}
  \pgfsetfillcolor{examplefill}
  \pgfusepath{stroke,fill}
\end{tikzpicture}
```

### 86.3 Quick Path Usage Commands

The quick path usage commands perform similar tasks as `\pgfusepath`, but they

- do not add arrows,
- do not modify the path in any way, in particular,
- ends are not shortened,
- corners are not replaced by arcs.

Note that you *have to* use the quick versions in the code of arrow tip definitions since, inside these definition, you obviously do not want arrows to be drawn.

`\pgfusepathqstroke`

Strokes the path without further ado. No arrows are drawn, no corners are arced.



```
\begin{pgfpicture}
  \pgfpathqcircle{5pt}
  \pgfusepathqstroke
\end{pgfpicture}
```

`\pgfusepathqfill`

Fills the path without further ado.

`\pgfusepathqfillstroke`

Fills and then strokes the path without further ado.

`\pgfusepathqclip`

Clips all subsequent drawings against the current path. The path is not processed.

### 86.4 Quick Text Box Commands

`\pgfqbox{⟨box number⟩}`

This command inserts a  $\text{\TeX}$  box into a `{pgfpicture}` by “escaping” to  $\text{\TeX}$ , inserting the box number  $\langle box number \rangle$  at the origin, and then returning to the typesetting the picture.

`\pgfqboxsynced{⟨box number⟩}`

This command works similarly to the `\pgfqbox` command. However, before inserting the text in  $\langle box number \rangle$ , the current coordinate transformation matrix is applied to the current canvas transformation matrix (is it “synced” with this matrix, hence the name).

Thus, this command basically has the same effect as if you first called `\pgflowlevelsync` followed by `\pgfqbox`. However, this command will use `\hskip` and `\raise` commands for the “translational part” of the coordinate transformation matrix, instead of adding the translational part to the current canvas transformation matrix directly. Both methods have the same effect (box  $\langle box number \rangle$  is translated where it should), but the method used by `\pgfqboxsynced` ensures that hyperlinks are placed correctly. Note that scaling and rotation will not (cannot, even) apply to hyperlinks.

# Part IX

## The System Layer

by Till Tantau

This part describes the low-level interface of PGF, called the *system layer*. This interface provides a complete abstraction of the internals of the underlying drivers.

Unless you intend to port PGF to another driver or unless you intend to write your own optimized frontend, you need not read this part.

In the following it is assumed that you are familiar with the basic workings of the `graphics` package and that you know what  $\TeX$ -drivers are and how they work.

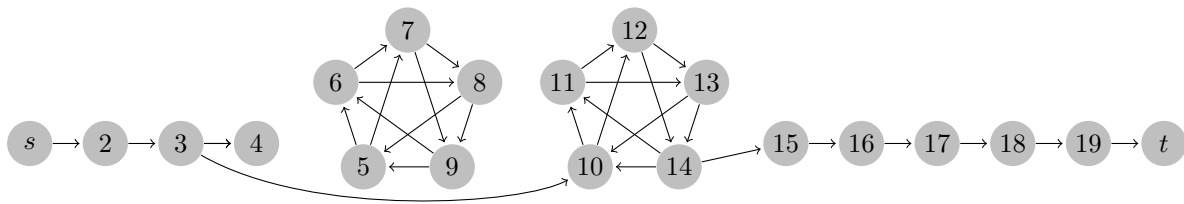

```
\begin{tikzpicture}
  [shorten >=1pt,->,
  vertex/.style={circle,fill=black!25,minimum size=17pt,inner sep=0pt}]

  \foreach \name/\x in {s/1, 2/2, 3/3, 4/4, 15/11, 16/12, 17/13, 18/14, 19/15, t/16}
    \node[vertex] (G-\name) at (\x,0) {$\name$};

  \foreach \name/\angle/\text in {P-1/234/5, P-2/162/6, P-3/90/7, P-4/18/8, P-5/-54/9}
    \node[vertex,xshift=6cm,yshift=.5cm] (\name) at (\angle:1cm) {$\text$};

  \foreach \name/\angle/\text in {Q-1/234/10, Q-2/162/11, Q-3/90/12, Q-4/18/13, Q-5/-54/14}
    \node[vertex,xshift=9cm,yshift=.5cm] (\name) at (\angle:1cm) {$\text$};

  \foreach \from/\to in {s/2,2/3,3/4,3/4,15/16,16/17,17/18,18/19,19/t}
    \draw (G-\from) -- (G-\to);

  \foreach \from/\to in {1/2,2/3,3/4,4/5,5/1,1/3,2/4,3/5,4/1,5/2}
    { \draw (P-\from) -- (P-\to); \draw (Q-\from) -- (Q-\to); }

  \draw (G-3) .. controls +(-30:2cm) and +(-150:1cm) .. (Q-1);
  \draw (Q-5) -- (G-15);
\end{tikzpicture}
```

## 87 Design of the System Layer

### 87.1 Driver Files

The PGF system layer mainly consists of a large number of commands starting with `\pgfsys@`. These commands will be called *system commands* in the following. The higher layers “interface” with the system layer by calling these commands. The higher layers should never use `\special` commands directly or even check whether `\pdfoutput` is defined. Instead, all drawing requests should be “channeled” through the system commands.

The system layer is loaded and setup by the following package:

```
\usepackage{pgfsys} % LATEX
\input pgfsys.tex % plain TEX
\usemodule[pgfsys] % ConTEXt
```

This file provides “default implementations” of all system commands, but most simply produce a warning that they are not implemented. The actual implementations of the system commands for a particular driver like, say, `pdftex` reside in files called `pgfsys-xxxx.sty`, where `xxxx` is the driver name. These will be called *driver files* in the following.

When `pgfsys.sty` is loaded, it will try to determine which driver is used by loading `pgf.cfg`. This file should setup the macro `\pgfsysdriver` appropriately. The, `pgfsys.sty` will input the appropriate `pgfsys-⟨drivername⟩.sty`.

#### `\pgfsysdriver`

This macro should expand to the name of the driver to be used by `pgfsys`. The default from `pgf.cfg` is `pgfsys-\Gin@driver`. This is very likely to be correct if you are using L<sup>A</sup>T<sub>E</sub>X. For plain T<sub>E</sub>X, the macro will be set to `pgfsys-pdftex.def` if `pdftex` is used and to `pgfsys-dvips.def` otherwise.

#### File `pgf.cfg`

This file should setup the command `\pgfsysdriver` correctly. If `\pgfsysdriver` is already set to some value, the driver normally should not change it. Otherwise, it should make a “good guess” at which driver will be appropriate.

The currently supported backend drivers are discussed in Section 10.2.

### 87.2 Common Definition Files

Some drivers share many `\pgfsys@` commands. For the reason, files defining these “common” commands are available. These files are *not* usable alone.

#### File `pgfsys-common-postscript`

This file defines some `\pgfsys@` commands so that they produce appropriate PostScript code.

#### File `pgfsys-common-pdf`

This file defines some `\pgfsys@` commands so that they produce appropriate PDF code.

## 88 Commands of the System Layer

### 88.1 Beginning and Ending a Stream of System Commands

A “user” of the PGF system layer (like the basic layer or a frontend) will interface with the system layer by calling a stream of commands starting with `\pgfsys@`. From the system layer’s point of view, these commands form a long stream. Between calls to the system layer, control goes back to the user.

The driver files implement system layer commands by inserting `\special` commands that implement the desired operation. For example, `\pgfsys@stroke` will be mapped to `\special{pdf: S}` by the driver file for `pdftex`.

For many drivers, when such a stream of specials starts, it is necessary to install an appropriate transformation and perhaps perform some more bureaucratic tasks. For this reason, every stream will start with a `\pgfsys@beginpicture` and will end with a corresponding ending command.

#### `\pgfsys@beginpicture`

Called at the beginning of a `{pgfpicture}`. This command should “setup things.”

Most drivers will need to implement this command.

#### `\pgfsys@endpicture`

Called at the end of a `pgfpicture`.

Most drivers will need to implement this command.

#### `\pgfsys@typesetpicturebox{<box>}`

Called *after* a `{pgfpicture}` has been typeset. The picture will have been put in box `<box>`. This command should insert the box into the normal text. The box `<box>` will still be a “raw” box that contains only the `\special`’s that make up the description of the picture. The job of this command is to resize and shift `<box>` according to the baseline shift and the size of the box.

This command has a default implementation and need not be implemented by a driver file.

#### `\pgfsys@beginpurepicture`

This version of the `\pgfsys@beginpicture` picture command can be used for pictures that are guaranteed not to contain any escaped boxes (see below). In this case, a driver might provide a more compact version of the command.

This command has a default implementation and need not be implemented by a driver file.

#### `\pgfsys@endpurepicture`

Called at the end of a “pure” `{pgfpicture}`.

This command has a default implementation and need not be implemented by a driver file.

Inside a stream it is sometimes necessary to “escape” back into normal typesetting mode; for example to insert some normal text, but with all of the current transformations and clippings being in force. For this escaping, the following command is used:

#### `\pgfsys@hbox{<box number>}`

Called to insert a (horizontal) TeX box inside a `{pgfpicture}`.

Most drivers will need to (re-)implement this command.

#### `\pgfsys@hboxsynced{<box number>}`

Called to insert a (horizontal) TeX box inside a `{pgfpicture}`, but with the current coordinate transformation matrix synced with the canvas transformation matrix.

This command should do the same as if you used `\pgflowlevelsynccm` followed by `\pgfsys@hbox`. However, the default implementation of this command will use a “TeX-translation” for the translation part of the transformation matrix. This will ensure that hyperlinks “survive” at least translations. On the other hand, a driver may choose to revert to a simpler implementation. This is done, for example, for the SVG implementation, where a TeX-translation makes no sense.



## 88.2 Path Construction System Commands

### `\pgfsys@moveto`{ $\langle x \rangle$ }{ $\langle y \rangle$ }

This command is used to start a path at a specific point  $(x, y)$  or to move the current point of the current path to  $(x, y)$  without drawing anything upon stroking (the current path is “interrupted”).

Both  $\langle x \rangle$  and  $\langle y \rangle$  are given as T<sub>E</sub>X dimensions. It is the driver’s job to transform these to the coordinate system of the backend. Typically, this means converting the T<sub>E</sub>X dimension into a dimensionless multiple of  $\frac{1}{72}$ in. The function `\pgf@sys@bp` helps with this conversion.

*Example:* Draw a line from (10pt, 10pt) to the origin of the picture.

```
\pgfsys@moveto{10pt}{10pt}
\pgfsys@lineto{0pt}{0pt}
\pgfsys@stroke
```

This command is protooled, see Section 90.

### `\pgfsys@lineto`{ $\langle x \rangle$ }{ $\langle y \rangle$ }

Continue the current path to  $(x, y)$  with a straight line.

This command is protooled, see Section 90.

### `\pgfsys@curveto`{ $\langle x_1 \rangle$ }{ $\langle y_1 \rangle$ }{ $\langle x_2 \rangle$ }{ $\langle y_2 \rangle$ }{ $\langle x_3 \rangle$ }{ $\langle y_3 \rangle$ }

Continue the current path to  $(x_3, y_3)$  with a Bézier curve that has the two control points  $(x_1, y_1)$  and  $(x_2, y_2)$ .

*Example:* Draw a good approximation of a quarter circle:

```
\pgfsys@moveto{10pt}{0pt}
\pgfsys@curveto{10pt}{5.55pt}{5.55pt}{10pt}{0pt}{10pt}
\pgfsys@stroke
```

This command is protooled, see Section 90.

### `\pgfsys@rect`{ $\langle x \rangle$ }{ $\langle y \rangle$ }{ $\langle width \rangle$ }{ $\langle height \rangle$ }

Append a rectangle to the current path whose lower left corner is at  $(x, y)$  and whose width and height in big points are given by  $\langle width \rangle$  and  $\langle height \rangle$ .

This command can be “mapped back” to `\pgfsys@moveto` and `\pgfsys@lineto` commands, but it is included since PDF has a special, quick version of this command.

This command is protooled, see Section 90.

### `\pgfsys@closepath`

Close the current path. This results in joining the current point of the path with the point specified by the last `\pgfsys@moveto` operation. Typically, this is preferable over using `\pgfsys@lineto` to the last point specified by a `\pgfsys@moveto`, since the line starting at this point and the line ending at this point will be smoothly joined by `\pgfsys@closepath`.

*Example:* Consider

```
\pgfsys@moveto{0pt}{0pt}
\pgfsys@lineto{10bp}{10bp}
\pgfsys@lineto{0bp}{10bp}
\pgfsys@closepath
\pgfsys@stroke
```

and

```
\pgfsys@moveto{0bp}{0bp}
\pgfsys@lineto{10bp}{10bp}
\pgfsys@lineto{0bp}{10bp}
\pgfsys@lineto{0bp}{0bp}
\pgfsys@stroke
```

The difference between the above will be that in the second triangle the corner at the origin will be wrong; it will just be the overlay of two lines going in different directions, not a sharp pointed corner.

This command is protooled, see Section 90.

## 88.3 Canvas Transformation System Commands

`\pgfsys@transformcm`{ $\langle a \rangle$ }{ $\langle b \rangle$ }{ $\langle c \rangle$ }{ $\langle d \rangle$ }{ $\langle e \rangle$ }{ $\langle f \rangle$ }

Perform a concatenation of the canvas transformation matrix with the matrix given by the values  $\langle a \rangle$  to  $\langle f \rangle$ , see the PDF or PostScript manual for details. The values  $\langle a \rangle$  to  $\langle d \rangle$  are dimensionless factors,  $\langle e \rangle$  and  $\langle f \rangle$  are TeX dimensions

*Example:* `\pgfsys@transformcm{1}{0}{0}{1}{1cm}{1cm}`.

This command is protocolled, see Section 90.

`\pgfsys@transformshift`{ $\langle x \text{ displacement} \rangle$ }{ $\langle y \text{ displacement} \rangle$ }

This command will change the origin of the canvas to  $(x, y)$ .

This command has a default implementation and need not be implemented by a driver file.

This command is protocolled, see Section 90.

`\pgfsys@transformxyscale`{ $\langle x \text{ scale} \rangle$ }{ $\langle y \text{ scale} \rangle$ }

This command will scale the canvas (and everything that is drawn) by a factor of  $\langle x \text{ scale} \rangle$  in the  $x$ -direction and  $\langle y \text{ scale} \rangle$  in the  $y$ -direction. Note that this applies to everything, including lines. So a scaled line will have a different width and may even have a different width when going along the  $x$ -axis and when going along the  $y$ -axis, if the scaling is different in these directions. Usually, you do not want this.

This command has a default implementation and need not be implemented by a driver file.

This command is protocolled, see Section 90.

## 88.4 Stroking, Filling, and Clipping System Commands

`\pgfsys@stroke`

Stroke the current path (as if it were drawn with a pen). A number of graphic state parameters influence this, which can be set using appropriate system commands described later.

**Line width** The “thickness” of the line. A width of 0 is the thinnest width renderable on the device.

On a high-resolution printer this may become invisible and should be avoided. A good choice is 0.4pt, which is the default.

**Stroke color** This special color is used for stroking. If it is not set, the current color is used.

**Cap** The cap describes how the endings of lines are drawn. A round cap adds a little half circle to these endings. A butt cap ends the lines exactly at the end (or start) point without anything added. A rectangular cap ends the lines like the butt cap, but the lines protrude over the endpoint by the line thickness. (See also the PDF manual.) If the path has been closed, no cap is drawn.

**Join** This describes how a bend (a join) in a path is rendered. A round join draws bends using small arcs. A bevel join just draws the two lines and then fills the join minimally so that it becomes convex. A miter join extends the lines so that they form a single sharp corner, but only up to a certain miter limit. (See the PDF manual once more.)

**Dash** The line may be dashed according to a dashing pattern.

**Clipping area** If a clipping area is established, only those parts of the path that are inside the clipping area will be drawn.

In addition to stroking a path, the path may also be used for clipping after it has been stroked. This will happen if the `\pgfsys@clipnext` is used prior to this command, see there for details.

This command is protocolled, see Section 90.

`\pgfsys@closestroke`

This command should have the same effect as first closing the path and then stroking it.

This command has a default implementation and need not be implemented by a driver file.

This command is protocolled, see Section 90.

### `\pgfsys@fill`

This command fills the area surrounded by the current path. If the path has not yet been closed, it is closed prior to filling. The path itself is not stroked. For self-intersecting paths or paths consisting of multiple parts, the nonzero winding number rule is used to determine whether a point is inside or outside the path, except if `\ifpgfsys@eorule` holds – in which case the even-odd rule should be used. (See the PDF or PostScript manual for details.)

The following graphic state parameters influence the filling:

**Interior rule** If `\ifpgfsys@eorule` is set, the even-odd rule is used, otherwise the non-zero winding number rule.

**Fill color** If the fill color is not especially set, the current color is used.

**Clipping area** If a clipping area is established, only those parts of the filling area that are inside the clipping area will be drawn.

In addition to filling the path, the path will also be used for clipping if `\pgfsys@clipnext` is used prior to this command.

This command is protocolled, see Section 90.

### `\pgfsys@fillstroke`

First, the path is filled, then the path is stroked. If the fill and stroke colors are the same (or if they are not specified and the current color is used), this yields almost the same as a `\pgfsys@fill`. However, due to the line thickness of the stroked path, the fill-stroked area will be slightly larger.

In addition to stroking and filling the path, the path will also be used for clipping if `\pgfsys@clipnext` is used prior to this command.

This command is protocolled, see Section 90.

### `\pgfsys@discardpath`

Normally, this command should “throw away” the current path. However, after `\pgfsys@clipnext` has been called, the current path should subsequently be used for clipping. See `\pgfsys@clipnext` for details.

This command is protocolled, see Section 90.

### `\pgfsys@clipnext`

This command should be issued after a path has been constructed, but before it has been stroked and/or filled or discarded. When the command is used, the next stroking/filling/discarding command will first be executed normally. Then, afterwards, the just-used path will be used for subsequent clipping. If there has already been a clipping region, this region is intersected with the new clipping path (the clipping cannot get bigger). The nonzero winding number rule is used to determine whether a point is inside or outside the clipping area or the even-odd rule, depending on whether `\ifpgfsys@eorule` holds.

## 88.5 Graphic State Option System Commands

### `\pgfsys@setlinewidth{<width>}`

Sets the width of lines, when stroked, to `<width>`, which must be a TeX dimension.

This command is protocolled, see Section 90.

### `\pgfsys@buttcap`

Sets the cap to a butt cap. See `\pgfsys@stroke`.

This command is protocolled, see Section 90.

### `\pgfsys@roundcap`

Sets the cap to a round cap. See `\pgfsys@stroke`.

This command is protocolled, see Section 90.

### `\pgfsys@rectcap`

Sets the cap to a rectangular cap. See `\pgfsys@stroke`.

This command is protocolled, see Section 90.

### `\pgfsys@miterjoin`

Sets the join to a miter join. See `\pgfsys@stroke`.

This command is protocolled, see Section 90.

### `\pgfsys@setmiterlimit{<factor>}`

Sets the miter limit of lines to `<factor>`. See the PDF or PostScript for details on what the miter limit is.

This command is protocolled, see Section 90.

### `\pgfsys@roundjoin`

Sets the join to a round join. See `\pgfsys@stroke`.

This command is protocolled, see Section 90.

### `\pgfsys@beveljoin`

Sets the join to a bevel join. See `\pgfsys@stroke`.

This command is protocolled, see Section 90.

### `\pgfsys@setdash{<pattern>}{<phase>}`

Sets the dashing pattern. `<pattern>` should be a list of TeX dimensions lengths separated by commas. `<phase>` should be a single dimension.

*Example:* `\pgfsys@setdash{3pt,3pt}{0pt}`

The list of values in `<pattern>` is used to determine the lengths of the “on” phases of the dashing and of the “off” phases. For example, if `<pattern>` is `3bp,4bp`, then the dashing pattern is “3bp on followed by 4bp off, followed by 3bp on, followed by 4bp off, and so on.” A pattern of `.5pt,4pt,3pt,1.5pt` means “.5pt on, 4pt off, 3pt on, 1.5pt off, .5pt on, ...” If the number of entries is odd, the last one is used twice, so `3pt` means “3pt on, 3pt off, 3pt on, 3pt off, ...” An empty list means “always on.”

The second argument determines the “phase” of the pattern. For example, for a pattern of `3bp,4bp` and a phase of `1bp`, the pattern would start: “2bp on, 4bp off, 3bp on, 4bp off, 3bp on, 4bp off, ...”

This command is protocolled, see Section 90.

### `\ifpgfsys@eorule`

Determines whether the even odd rule is used for filling and clipping or not.

## 88.6 Color System Commands

The PGF system layer provides a number of system commands for setting colors. These commands coexist with commands from the `color` and `xcolor` package, which perform similar functions. However, the `color` package does not support having two different colors for stroking and filling, which is a useful feature that is supported by PGF. For this reason, the PGF system layer offers commands for setting these colors separately. Also, plain TeX profits from the fact that PGF can set colors.

For PDF, implementing these color commands is easy since PDF supports different stroking and filling colors directly. For PostScript, a more complicated approach is needed in which the colors need to be stored in special PostScript variables that are set whenever a stroking or a filling operation is done.

### `\pgfsys@color@rgb{<red>}{<green>}{<blue>}`

Sets the color used for stroking and filling operations to the given red/green/blue tuple (numbers between 0 and 1).

This command is protocolled, see Section 90.

### `\pgfsys@color@rgb@stroke{<red>}{<green>}{<blue>}`

Sets the color used for stroking operations to the given red/green/blue tuple (numbers between 0 and 1).

*Example:* Make stroked text dark red: `\pgfsys@color@rgb@stroke{0.5}{0}{0}`

The special stroking color is only used if the stroking color has been set since the last `\color` or `\pgfsys@color@xxx` command. Thus, each `\color` command will reset both the stroking and filling colors by calling `\pgfsys@color@reset`.

This command is protocolled, see Section 90.

`\pgfsys@color@rgb@fill{<red>}{<green>}{<blue>}`

Sets the color used for filling operations to the given red/green/blue tuple (numbers between 0 and 1). This color may be different from the stroking color.

This command is protocolled, see Section 90.

`\pgfsys@color@cmyk{<cyan>}{<magenta>}{<yellow>}{<black>}`

Sets the color used for stroking and filling operations to the given cymk tuple (numbers between 0 and 1).

This command is protocolled, see Section 90.

`\pgfsys@color@cmyk@stroke{<cyan>}{<magenta>}{<yellow>}{<black>}`

Sets the color used for stroking operations to the given cymk tuple (numbers between 0 and 1).

This command is protocolled, see Section 90.

`\pgfsys@color@cmyk@fill{<cyan>}{<magenta>}{<yellow>}{<black>}`

Sets the color used for filling operations to the given cymk tuple (numbers between 0 and 1).

This command is protocolled, see Section 90.

`\pgfsys@color@cmy{<cyan>}{<magenta>}{<yellow>}`

Sets the color used for stroking and filling operations to the given cym tuple (numbers between 0 and 1).

This command is protocolled, see Section 90.

`\pgfsys@color@cmy@stroke{<cyan>}{<magenta>}{<yellow>}`

Sets the color used for stroking operations to the given cym tuple (numbers between 0 and 1).

This command is protocolled, see Section 90.

`\pgfsys@color@cmy@fill{<cyan>}{<magenta>}{<yellow>}`

Sets the color used for filling operations to the given cym tuple (numbers between 0 and 1).

This command is protocolled, see Section 90.

`\pgfsys@color@gray{<black>}`

Sets the color used for stroking and filling operations to the given black value, where 0 means black and 1 means white.

This command is protocolled, see Section 90.

`\pgfsys@color@gray@stroke{<black>}`

Sets the color used for stroking operations to the given black value, where 0 means black and 1 means white.

This command is protocolled, see Section 90.

`\pgfsys@color@gray@fill{<black>}`

Sets the color used for filling operations to the given black value, where 0 means black and 1 means white.

This command is protocolled, see Section 90.

`\pgfsys@color@reset`

This command will be called when the `\color` command is used. It should purge any internal settings of stroking and filling color. After this call, till the next use of a command like `\pgfsys@color@rgb@fill`, the current color installed by the `\color` command should be used.

If the  $\text{\TeX}$ -if `\pgfsys@color@reset@inorder` is set to true, this command may “assume” that any call to a color command that sets the fill or stroke color came “before” the call to this command and may try to optimize the output accordingly.

An example of an incorrect “out of order” call would be using `\pgfsys@color@reset` at the beginning of a box that is constructed using `\setbox`. Then, when the box is constructed, no special fill or stroke color might be in force. However, when the box is later on inserted at some point, a special fill color might already have been set. In this case, this command is not guaranteed to reset the color correctly.

### `\pgfsys@color@reset@inordertrue`

Sets the optimized “in order” version of the color resetting. This is the default.

### `\pgfsys@color@reset@inorderfalse`

Switches off the optimized color resetting.

### `\pgfsys@color@unstacked{<LATEX color>}`

This slightly obscure command causes the color stack to be tricked. When called, this command should set the current color to `<LATEX color>` without causing any change in the color stack.

*Example:* `\pgfsys@color@unstacked{red}`

## 88.7 Pattern System Commands

### `\pgfsys@declarepattern{<name>}{<x1>}{<y1>}{<x2>}{<y2>} {<x step>}{<y step>}{<code>}{<flag>}`

This command declares a new colored or uncolored pattern, depending on whether `<flag>` is 0, which means uncolored, or 1, which means colored. Uncolored patterns have no inherent color, the color is provided when they are set. Colored patterns have an inherent color.

The `<name>` is a name for later use when the pattern is to be shown. The pairs  $(x_1, y_1)$  and  $(x_2, y_2)$  must describe a bounding box of the pattern `<code>`.

The tiling step of the pattern is given by `<x step>` and `<y step>`.

*Example:*

```
\pgfsys@declarepattern{hori}{-.5pt}{0pt}{.5pt}{3pt}{3pt}{3pt}
{\pgfsys@moveto{0pt}{0pt}\pgfsys@lineto{0pt}{3pt}\pgfsys@stroke}
{0}
```

### `\pgfsys@setpatternuncolored{<name>}{<red>}{<green>}{<blue>}`

Sets the fill color to the pattern named `<name>`. This pattern must previously have been declared with `<flag>` set to 0. The color of the pattern is given in the parameters `<red>`, `<green>`, and `<blue>` in the usual way.

The fill color “pattern” will persist till the next color command that modifies the fill color.

### `\pgfsys@setpatterncolored{<name>}`

Sets the fill color to the pattern named `<name>`. This pattern must have been declared with the 1 flag.

## 88.8 Scoping System Commands

The scoping commands are used to keep changes of the graphics state local.

### `\pgfsys@beginscope`

Saves the current graphic state on a graphic state stack. All changes to the graphic state parameters mentioned for `\pgfsys@stroke` and `\pgfsys@fill` will be local to the current graphic state and the old values will be restored after `\pgfsys@endscope` is used.

*Warning:* PDF and PostScript differ with respect to the question of whether the current path is part of the graphic state or not. For this reason, you should never use this command unless the path is currently empty. For example, it might be a good idea to use `\pgfsys@discardpath` prior to calling this command.

This command is protooled, see Section 90.

### `\pgfsys@endscope`

Restores the last saved graphic state.

This command is protooled, see Section 90.

## 88.9 Image System Commands

The system layer provides some commands for image inclusion.

### `\pgfsys@imagesuffixlist`

This macro should expand to a list of suffixes, separated by ‘:’, that will be tried when searching for an image.

*Example:* `\def\pgfsys@imagesuffixlist{eps:epsi:ps}`

### `\pgfsys@defineimage`

Called, when an image should be defined.

This command does not take any parameters. Instead, certain macros will be preinstalled with appropriate values when this command is invoked. These are:

- `\pgf@filename` File name of the image to be defined.
- `\pgf@imagewidth` Will be set to the desired (scaled) width of the image.
- `\pgf@imageheight` Will be set to the desired (scaled) height of the image.  
If this macro and also the height macro are empty, the image should have its “natural” size.  
If exactly only of them is specified, the undefined value the image is scaled so that the aspect ratio is kept.  
If both are set, the image is scaled in both directions independently, possibly changing the aspect ratio.

The following macros presumable mostly make sense for drivers that can handle PDF:

- `\pgf@imagepage` The desired page number to be extracted from a multi-page “image.”
- `\pgf@imagemask` If set, it will be set to `/SMask x 0 R` where `x` is the PDF object number of a soft mask to be applied to the image.
- `\pgf@imageinterpolate` If set, it will be set to `/Interpolate true` or `/Interpolate false`, indicating whether the image should be interpolated in PDF.

The command should now setup the macro `\pgf@image` such that calling this macro will result in typesetting the image. Thus, `\pgf@image` is the “return value” of the command.

This command has a default implementation and need not be implemented by a driver file.

## 88.10 Shading System Commands

### `\pgfsys@horishading{<name>}{<height>}{<specification>}`

Declares a horizontal shading for later use. The effect of this command should be the definition of a macro called `\@pgfshading<name>!` (or `\csname @pdfshading<name>!&endcsname`, to be precise). When invoked, this new macro should insert a shading at the current position.

`<name>` is the name of the shading, which is also used in the output macro name. `<height>` is the height of the shading and must be given as a TeX dimension like `2cm` or `10pt`. `<specification>` is a shading color specification as specified in Section 83. The shading specification implicitly fixes the width of the shading.

When `\@pgfshading<name>!` is invoked, it should insert a box of height `<height>` and the width implicit in the shading declaration.

### `\pgfsys@vertshading{<name>}{<width>}{<specification>}`

Like the horizontal version, only for vertical shadings. This time, the height of the shading is implicit in `<specification>` and the width is given as `<width>`.

### `\pgfsys@radialshading{<name>}{<starting point>}{<specification>}`

Declares a radial shading. Like the previous macros, this command should setup the macro `\@pgfshading<name>!`, which upon invocation should insert a radial shading whose size is implicit in `<specification>`.

The parameter `<starting point>` is a PGF point specifying the inner starting point of the shading.



`\pgfsys@functionalshading`{*<name>*}{*<lower left corner>*}{*<upper right corner>*}{*<type 4 function>*}

Declares a shading using a PostScript-like function that provides a color for each point. Like the previous macros, this command should setup the macro `\pgfshading`*<name>*! so that it will produce a box containing the desired shading.

Parameter *<name>* is the name of the shading. Parameter *<type 4 function>* is a Postscript-like function (type 4 function of the PDF specification) as described in Section 3.9.4 of the PDF Specification version 1.7. Parameters *<lower left corner>* and *<upper right corner>* are PGF points that specifies the lower left and upper right corners of the shading.

When *<type 4 function>* is evaluated, the coordinate of the current point will be on the (virtual) PostScript stack in bp units. After the function has been evaluated, the stack should consist of three numbers (not integers! – the Apple PDF renderer is broken in this regard, so add `cvr`'s at the end if needed) that represent the red, green, and blue components of the color.

A buggy function will result is *totally unpredictable chaos* during rendering.

## 88.11 Transparency System Commands

`\pgfsys@stroke@opacity`{*<value>*}

Sets the opacity of stroking operations.

`\pgfsys@fill@opacity`{*<value>*}

Sets the opacity of filling operations.

`\pgfsys@transparencygroupfrombox`{*<box>*}

This takes a TeX box and converts it into a transparency group. This means that any transparency settings apply to the box as a whole. For instance, if a box contains two overlapping black circles and you draw the box and, thus, the two circles normally with 50% transparency, then the overlap will be darker than the rest. By comparison, if the circles are part of a transparency group, the overlap will get the same color as the rest.

`\pgfsys@fadingfrombox`{*<name>*}{*<box>*}

Declares the fading *<name>*. The *<box>* is a TeX-box. Its contents luminosity determines the opacity of the resulting fading. This means that the lighter a pixel inside the box, the more opaque the fading will be at this position.

`\pgfsys@usefading`*<name>*{*<a>*}{*<b>*}{*<c>*}{*<d>*}{*<e>*}{*<f>*}

Installs a previously declared fading *<name>* in the current graphics state. Afterwards, all drawings will be masked by the fading. The fading should be centered on the origin and have its original size, except that the parameters *<a>* to *<f>* specify a transformation matrix that should be applied additionally to the fading before it is installed. The transformtion should not apply to the following graphics, however.

`\pgfsys@definemask`

This command declares a fading (known as a soft mask in this context) based on an image and for usage with images. It works similar to `\pgfsys@defineimage`: Certain macros are set when the command is called. The result should be to set the macro `\pgf@mask` to a pdf object count that can subsequently be used as a transparency mask. The following macros will be set when this command is invoked:

- `\pgf@filename` File name of the mask to be defined.
- `\pgf@maskmatte` The so-called matte of the mask (see the PDF documentation for details). The matte is a color specification consisting of 1, 3 or 4 numbers between 0 and 1. The number of numbers depends on the number of color channels in the image (not in the mask!). It will be assumed that the image has been preblended with this color.

## 88.12 Reusable Objects System Commands

`\pgfsys@invoke`{*<literals>*}

This command gets protocolled literals and should insert them into the `.pdf` or `.dvi` file using an appropriate `\special`.



`\pgfsys@defobject{⟨name⟩}{⟨lower left⟩}{⟨upper right⟩}{⟨code⟩}`

Declares an object for later use. The idea is that the object can be precached in some way and then be rendered more quickly when used several times. For example, an arrow head might be defined and prerendered in this way.

The parameter  $\langle name \rangle$  is the name for later use.  $\langle lower\ left \rangle$  and  $\langle upper\ right \rangle$  are PGF points specifying a bounding box for the object.  $\langle code \rangle$  is the code for the object. The code should not be too fancy.

This command has a default implementation and need not be implemented by a driver file.

`\pgfsys@useobject{⟨name⟩}{⟨extra code⟩}`

Renders a previously declared object. The first parameter is the name of the the object. The second parameter is extra code that should be executed right *before* the object is rendered. Typically, this will be some transformation code.

This command has a default implementation and need not be implemented by a driver file.

## 88.13 Invisibility System Commands

All drawing or stroking or text rendering between calls of the following commands should be suppressed. A similar effect can be achieved by clipping against an empty region, but the following commands do not open a graphics scope and can be opened and closed “orthogonally” to other scopes.

`\pgfsys@begininvisible`

Between this command and the closing `\pgfsys@endinvisible` all output should be suppressed. Nothing should be drawn at all, which includes all paths, images and shadings. However, no groups (neither T<sub>E</sub>X groups nor graphic state groups) should be opened by this command.

This command has a default implementation and need not be implemented by a driver file.

This command is protocolled, see Section 90.

`\pgfsys@endinvisible`

Ends the invisibility section, unless invisibility blocks have been nested. In this case, only the “last” one restores visibility.

This command has a default implementation and need not be implemented by a driver file.

This command is protocolled, see Section 90.

## 88.14 Position Tracking Commands

The following commands are used to determine the position of text on a page. This is a rather complicated process in general since at the moment when the text is read by T<sub>E</sub>X the final position cannot be determined, yet. For example, the text might be put in a box which is later put in the headline or perhaps in the footline or perhaps even on a different page.

For these reasons, position tracking is typically a two-stage process. In a first stage you indicate that a certain position is of interest by *marking* it. This will (depending on the details of the backend driver) cause page coordinates or this position to be written to a `.aux` file when the page is shipped. Possibly, the position might also be determined at an even later stage. Then, on a second run of T<sub>E</sub>X, the position is read from the `.aux` file and can be used.

`\pgfsys@markposition{⟨name⟩}`

Marks a position on the page. This command should be given while normal typesetting is done such as in

```
The value of  $\$x\$$  is \pgfsys@markposition{here}important.
```

It causes the position `here` to be saved when the page is shipped out.

`\pgfsys@getposition{⟨name⟩}{⟨macro⟩}`

This command retrieves a position that has been marked on an earlier run of T<sub>E</sub>X on the current file. The  $\langle macro \rangle$  must be a macro name such as `\mymarco`. It will redefined such that it is

- either just `\relax` or

- a `\pgfpoint...` command.

The first case will happen when the position has not been marked at all or when the file is typeset for the first time, when the coordinates are not yet available.

In the second case, executing  $\langle macro \rangle$  yields the position on the page that is to be interpreted as follows: A coordinate like `\pgfpoint{2cm}{3cm}` means “2cm to the right and 3cm up from the origin of the page.” The position of the origin of the page is not guaranteed to be at the lower left corner, it is only guaranteed that all pictures on a page use the same origin.

To determine the lower left corner of a page, you can call `\pgfsys@getposition` with  $\langle name \rangle$  set to the special name `pgfpageorigin`. By shifting all positions by the amount returned by this call you can position things absolutely on a page.

*Example:* Referencing a point or the page:

```
The value of $x$ is \pgfsys@markposition{here}important.

Lots of text.

\hbox{\pgfsys@markposition{myorigin}%
\begin{pgfpicture}
  % Switch of size protocol
  \pgfpathmoveto{\pgfpointorigin}
  \pgfusepath{use as bounding box}

  \pgfsys@getposition{here}{\hereposition}
  \pgfsys@getposition{myorigin}{\thispictureposition}

  \pgftransformshift{\pgfpointscale{-1}{\thispictureposition}}
  \pgftransformshift{\hereposition}

  \pgfpathcircle{\pgfpointorigin}{1cm}
  \pgfusepath{draw}
\end{pgfpicture}}
```

## 88.15 Internal Conversion Commands

The system commands take T<sub>E</sub>X dimensions as input, but the dimensions that have to be inserted into PDF and PostScript files need to be dimensionless values that are interpreted as multiples of  $\frac{1}{72}$ in. For example, the T<sub>E</sub>X dimension `2bp` should be inserted as 2 into a PDF file and the T<sub>E</sub>X dimension `10pt` as 9.9626401. To make this conversion easier, the following command may be useful:

`\pgf@sys@bp{ $\langle dimension \rangle$ }`

Inserts how many multiples of  $\frac{1}{72}$ in the  $\langle dimension \rangle$  is into the current protocol stream (buffered).

*Example:* `\pgf@sys@bp{\pgf@x}` or `\pgf@sys@bp{1cm}`.

Note that this command is *not* a system command that can/needs to be overwritten by a driver.

## 89 The Soft Path Subsystem

This section describes a set of commands for creating *soft paths* as opposed to the commands of the previous section, which created *hard paths*. A soft path is a path that can still be “changed” or “molded.” Once you (or the PGF system) is satisfied with a soft path, it is turned into a hard path, which can be inserted into the resulting `.pdf` or `.ps` file.

Note that the commands described in this section are “high-level” in the sense that they are not implemented in driver files, but rather directly by the PGF-system layer. For this reason, the commands for creating soft paths do not start with `\pgfsys@`, but rather with `\pgfsyssoftpath@`. On the other hand, as a user you will never use these commands directly, so they are described as part of the low-level interface.

### 89.1 Path Creation Process

When the user writes a command like `\draw (0bp,0bp) -- (10bp,0bp);` quite a lot happens behind the scenes:

1. The frontend command is translated by TikZ into commands of the basic layer. In essence, the command is translated to something like

```
\pgfpathmoveto{\pgfpoint{0bp}{0bp}}
\pgfpathlineto{\pgfpoint{10bp}{0bp}}
\pgfusepath{stroke}
```

2. The `\pgfpathxxxx` command do *not* directly call “hard” commands like `\pgfsys@xxxx`. Instead, the command `\pgfpathmoveto` invokes a special command called `\pgfsyssoftpath@moveto` and `\pgfpathlineto` invokes `\pgfsyssoftpath@lineto`.

The `\pgfsyssoftpath@xxxx` commands, which are described below, construct a soft path. Each time such a command is used, special tokens are added to the end of an internal macro that stores the soft path currently being constructed.

3. When the `\pgfusepath` is encountered, the soft path stored in the internal macro is “invoked.” Only now does a special macro iterate over the soft path. For each line-to or move-to operation on this path it calls an appropriate `\pgfsys@moveto` or `\pgfsys@lineto` in order to, finally, create the desired hard path, namely, the string of literals in the `.pdf` or `.ps` file.
4. After the path has been invoked, `\pgfsys@stroke` is called to insert the literal for stroking the path.

Why such a complicated process? Why not have `\pgfpathlineto` directly call `\pgfsys@lineto` and be done with it? There are two reasons:

1. The PDF specification requires that a path is not interrupted by any non-path-construction commands. Thus, the following code will result in a corrupted `.pdf`:

```
\pgfsys@moveto{0}{0}
\pgfsys@setlinewidth{1}
\pgfsys@lineto{10}{0}
\pgfsys@stroke
```

Such corrupt code is *tolerated* by most viewers, but not always. It is much better to create only (reasonably) legal code.

2. A soft path can still be changed, while a hard path is fixed. For example, one can still change the starting and end points of a soft path or do optimizations on it. Such transformations are not possible on hard paths.

### 89.2 Starting and Ending a Soft Path

No special action must be taken in order to start the creation of a soft path. Rather, each time a command like `\pgfsyssoftpath@lineto` is called, a special token is added to the (global) current soft path being constructed.

However, you can access and change the current soft path. In this way, it is possible to store a soft path, to manipulate it, or to invoke it.

`\pgfsyssoftpath@getcurrentpath{⟨macro name⟩}`

This command will store the current soft path in  $\langle macro\ name \rangle$ .

`\pgfsyssoftpath@setcurrentpath{⟨macro name⟩}`

This command will set the current soft path to be the path stored in  $\langle macro\ name \rangle$ . This macro should store a path that has previously been extracted using the `\pgfsyssoftpath@getcurrentpath` command and has possibly been modified subsequently.

`\pgfsyssoftpath@invokecurrentpath`

This command will turn the current soft path in a “hard” path. To do so, it iterates over the soft path and calls an appropriate `\pgfsys@xxxx` command for each element of the path. Note that the current soft path is *not changed* by this command. Thus, in order to start a new soft path after the old one has been invoked and is no longer needed, you need to set the current soft path to be empty. This may seem strange, but it is often useful to immediately use the last soft path again.

`\pgfsyssoftpath@flushcurrentpath`

This command will invoke the current soft path and then set it to be empty.

### 89.3 Soft Path Creation Commands

`\pgfsyssoftpath@moveto{⟨x⟩}{⟨y⟩}`

This command appends a “move-to” segment to the current soft path. The coordinates  $\langle x \rangle$  and  $\langle y \rangle$  are given as normal  $\text{\TeX}$  dimensions.

*Example:* One way to draw a line:

```
\pgfsyssoftpath@moveto{0pt}{0pt}
\pgfsyssoftpath@lineto{10pt}{10pt}
\pgfsyssoftpath@flushcurrentpath
\pgfsys@stroke
```

`\pgfsyssoftpath@lineto{⟨x⟩}{⟨y⟩}`

Appends a “line-to” segment to the current soft path.

`\pgfsyssoftpath@curveto{⟨a⟩}{⟨b⟩}{⟨c⟩}{⟨d⟩}{⟨x⟩}{⟨y⟩}`

Appends a “curve-to” segment to the current soft path with controls  $(a, b)$  and  $(c, d)$ .

`\pgfsyssoftpath@rect{⟨lower left x⟩}{⟨lower left y⟩}{⟨width⟩}{⟨height⟩}`

Appends a rectangle segment to the current soft path.

`\pgfsyssoftpath@closepath`

Appends a “close-path” segment to the current soft path.

### 89.4 The Soft Path Data Structure

A soft path is stored in a standardized way, which makes it possible to modify it before it becomes “hard.” Basically, a soft path is a long sequence of triples. Each triple starts with a *token* that identifies what is going on. This token is followed by two dimensions in braces. For example, the following is a soft path that means “the path starts at  $(0\text{bp}, 0\text{bp})$  and then continues in a straight line to  $(10\text{bp}, 0\text{bp})$ .”

```
\pgfsyssoftpath@movetotoken{0bp}{0bp}\pgfsyssoftpath@linetotoken{10bp}{0bp}
```

A curve-to is hard to express in this way since we need six numbers to express it, not two. For this reason, a curve-to is expressed using three triples as follows: The command

```
\pgfsyssoftpath@curveto{1bp}{2bp}{3bp}{4bp}{5bp}{6bp}
```

results in the following three triples:

```
\pgfsyssoftpath@curvetosupportatoken{1bp}{2bp}
\pgfsyssoftpath@curvetosupportbtoken{3bp}{4bp}
\pgfsyssoftpath@curvetotoken{5bp}{6bp}
```

These three triples must always “remain together.” Thus, a lonely `supportbtoken` is forbidden. In details, the following tokens exist:

- `\pgfsyssoftpath@movetotoken` indicates a move-to operation. The two following numbers indicate the position to which the current point should be moved.
- `\pgfsyssoftpath@linetotoken` indicates a line-to operation.
- `\pgfsyssoftpath@curvetosupportatoken` indicates the first control point of a curve-to operation. The triple must be followed by a `\pgfsyssoftpath@curvetosupportbtoken`.
- `\pgfsyssoftpath@curvetosupportbtoken` indicates the second control point of a curve-to operation. The triple must be followed by a `\pgfsyssoftpath@curvetotoken`.
- `\pgfsyssoftpath@curvetotoken` indicates the target of a curve-to operation.
- `\pgfsyssoftpath@rectcornertoken` indicates the corner of a rectangle on the soft path. The triple must be followed by a `\pgfsyssoftpath@rectsizetoken`.
- `\pgfsyssoftpath@rectsizetoken` indicates the size of a rectangle on the soft path.
- `\pgfsyssoftpath@closepath` indicates that the subpath begun with the last move-to operation should be closed. The parameter numbers are currently not important, but if set to anything different from `{0pt}{0pt}`, they should be set to the coordinate of the original move-to operation to which the path “returns” now.

## 90 The Protocol Subsystem

This section describes commands for *protocolling* literal text created by PGF. The idea is that some literal text, like the string of commands used to draw an arrow head, will be used over and over again in a picture. It is then much more efficient to compute the necessary literal text just once and to quickly insert it “in a single sweep.”

When protocolling is “switched on,” there is a “current protocol” to which literal text gets appended. Once all commands that needed to be protocolled have been issued, the protocol can be obtained and stored using `\pgfsysprotocol@getcurrentprotocol`. At any point, the current protocol can be changed using a corresponding setting command. Finally, `\pgfsysprotocol@invokecurrentprotocol` is used to insert the protocolled commands into the `.pdf` or `.dvi` file.

Only those `\pgfsys@` commands can be protocolled that use the command `\pgfsysprotocol@literal` internally. For example, the definition of `\pgfsys@moveto` in `pgfsys-common-pdf.def` is

```
\def\pgfsys@moveto#1#2{\pgfsysprotocol@literal{#1 #2 m}}
```

All “normal” system-level commands can be protocolled. However, commands for creating or invoking shadings, images, or whole pictures require special `\special`’s and cannot be protocolled.

**`\pgfsysprotocol@literalbuffered`**{*literal text*}

Adds the *literal text* to the current protocol, after it has been “`\edef`ed.” This command will always protocol.

**`\pgfsysprotocol@literal`**{*literal text*}

First calls `\pgfsysprotocol@literalbuffered` on *literal text*. Then, if protocolling is currently switched off, the *literal text* is passed on to `\pgfsys@invoke`.

**`\pgfsysprotocol@bufferedtrue`**

Turns on protocolling. All subsequent calls of `\pgfsysprotocol@literal` will append their argument to the current protocol.

**`\pgfsysprotocol@bufferedfalse`**

Turns off protocolling. Subsequent calls of `\pgfsysprotocol@literal` directly insert their argument into the current `.pdf` or `.ps`.

Note that if the current protocol is not empty when protocolling is switched off, the next call to `\pgfsysprotocol@literal` will first flush the current protocol, that is, insert it into the file.

**`\pgfsysprotocol@getcurrentprotocol`**{*macro name*}

Stores the current protocol in *macro name* for later use.

**`\pgfsysprotocol@setcurrentprotocol`**{*macro name*}

Sets the current protocol to *macro name*.

**`\pgfsysprotocol@invokecurrentprotocol`**

Inserts the text stored in the current protocol into the `.pdf` or `.dvi` file. This does *not* change the current protocol.

**`\pgfsysprotocol@flushcurrentprotocol`**

First inserts the current protocol, then sets the current protocol to the empty string.

# Part X

## References and Index

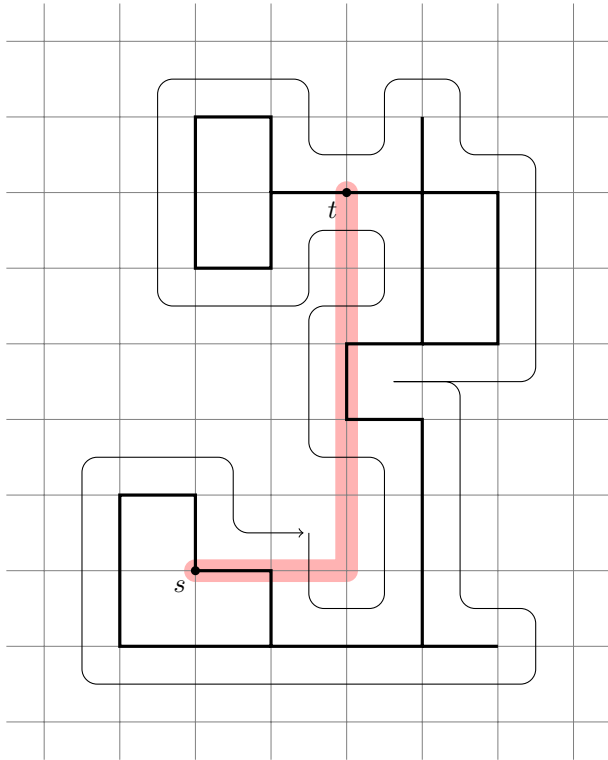

```

\begin{tikzpicture}
  \draw[line width=0.3cm,color=red!30,line cap=round,line join=round] (0,0)--(2,0)--(2,5);
  \draw[help lines] (-2.5,-2.5) grid (5.5,7.5);
  \draw[very thick] (1,-1)--(-1,-1)--(-1,1)--(0,1)--(0,0)--
    (1,0)--(1,-1)--(3,-1)--(3,2)--(2,2)--(2,3)--(3,3)--
    (3,5)--(1,5)--(1,4)--(0,4)--(0,6)--(1,6)--(1,5)
    (3,3)--(4,3)--(4,5)--(3,5)--(3,6)
    (3,-1)--(4,-1);
  \draw[below left] (0,0) node(s){$s$};
  \draw[below left] (2,5) node(t){$t$};
  \fill (0,0) circle (0.06cm) (2,5) circle (0.06cm);
  \draw[->,rounded corners=0.2cm,shorten >=2pt]
    (1.5,0.5)-- ++(0,-1)-- ++(1,0)-- ++(0,2)-- ++(-1,0)-- ++(0,2)-- ++(1,0)--
    ++(0,1)-- ++(-1,0)-- ++(0,-1)-- ++(-2,0)-- ++(0,3)-- ++(2,0)-- ++(0,-1)--
    ++(1,0)-- ++(0,1)-- ++(1,0)-- ++(0,-1)-- ++(1,0)-- ++(0,-3)-- ++(-2,0)--
    ++(1,0)-- ++(0,-3)-- ++(1,0)-- ++(0,-1)-- ++(-6,0)-- ++(0,3)-- ++(2,0)--
    ++(0,-1)-- ++(1,0);
\end{tikzpicture}

```

# Index

This index only contains automatically generated entries. A good index should also contain carefully selected keywords. This index is not a good index.

- ( arrow tip, 254
- ( ) group math operators, 524
- ) arrow tip, 254
- \* arrow tip, 254
- \* infix math operator, 524
- \* plot mark, 397
- || math operator, 524
- | arrow tip, 254, 609
- | plot mark, 398
- + infix math operator, 523
- + plot mark, 397
- infix math operator, 524
- plot mark, 398
- prefix math operator, 524
- path operation, 139
- | path operation, 139
- |- path operation, 139
- cycle path operation, 140
- plot path operation, 220
- .. path operation, 139
- / infix math operator, 524
- < infix math operator, 524
- <= infix math operator, 524
- == infix math operator, 524
- > infix math operator, 524
- > key, 158
- >= infix math operator, 524
- ? : conditional math operators, 524
- [ arrow tip, 254
- [ ] array access math operators, 525
- ^ infix math operator, 524
- { } array math operators, 525
- <chain name>-begin node, 283
- <chain name>-end node, 283
- <shape name> option, 171
- ] arrow tip, 254
- && infix math operator, 524
- 1000 sep key, 541
- 16 on 1 layout, 513
- 2 on 1 layout, 513
- 4 on 1 layout, 513
- 8 on 1 layout, 513
  
- above key, 181, 182
- above delimiter key, 370
- above left key, 181, 184, 185
- above right key, 182, 185
- abs math function, 527
- absolute key, 191
- accepting key, 257
- accepting above key, 258
- accepting below key, 258
- accepting by arrow key, 257
- accepting by double key, 257
- accepting left key, 258
- accepting right key, 258
- accepting text key, 257
  
- accepting where key, 257
- acos math function, 530
- .activate family handler, 496
- active families key, 496
- active families or no family key, 496
- active families or no family DEBUG key, 497
- .add handler, 490
- add math function, 526
- .add code handler, 488
- add exception key, 483
- .add style handler, 489
- adjustable key, 308
- \afterdecoration, 593
- alias key, 170
- align key, 177, 334
- all date test, 506
- allow upside down key, 189
- ampere key, 308
- ampersand replacement key, 206
- amplitude key, 316
- \anchor, 619
- anchor key, 126, 181, 205, 330, 366
- \anchorborder, 620
- and key, 498
- and math function, 531
- and gate key, 298, 299
- and gate IEC symbol key, 302
- angle key, 124, 127, 316
- angle 45 arrow tip, 253
- angle 45 reversed arrow tip, 253
- angle 60 arrow tip, 253
- angle 60 reversed arrow tip, 253
- angle 90 arrow tip, 253
- angle 90 reversed arrow tip, 253
- annotation key, 379
- annotation arrow key, 293, 307
- .append handler, 490
- append after command key, 138
- .append code handler, 488
- append filtered to key, 495
- .append style handler, 490
- arc path operation, 143
- array math function, 533
- \arrow, 327
- arrow box shape, 432
- arrow box arrows key, 433
- arrow box east arrow key, 433
- arrow box head extend key, 433
- arrow box head indent key, 433
- arrow box north arrow key, 433
- arrow box shaft width key, 433
- arrow box south arrow key, 433
- arrow box tip angle key, 432
- arrow box west arrow key, 433
- Arrow tips
  - (, 254
  - ), 254



- \* , 254
- | , 254, 609
- [ , 254
- ] , 254
- angle 45, 253
- angle 45 reversed, 253
- angle 60, 253
- angle 60 reversed, 253
- angle 90, 253
- angle 90 reversed, 253
- butt cap, 254
- diamond, 254
- direction ee, 309
- fast cap, 254
- fast cap reversed, 254
- hooks, 253
- hooks reversed, 253
- implies, 253
- latex, 253, 609
- latex reversed, 253, 609
- latex', 253
- latex' reversed, 253
- left hook, 254
- left hook reversed, 254
- left to, 254
- left to reversed, 254
- o, 254
- open diamond, 254
- open square, 254
- open triangle 45, 253
- open triangle 45 reversed, 253
- open triangle 60, 253
- open triangle 60 reversed, 253
- open triangle 90, 253
- open triangle 90 reversed, 253
- right hook, 254
- right hook reversed, 254
- right to, 254
- right to reversed, 254
- round cap, 254
- serif cm, 254
- space, 254
- square, 254
- stealth, 253, 609
- stealth reversed, 253, 609
- stealth', 253
- stealth' reversed, 253
- to, 253, 609
- to reversed, 253, 609
- triangle 45, 253
- triangle 45 reversed, 253
- triangle 60, 253
- triangle 60 reversed, 253
- triangle 90, 253
- triangle 90 cap, 254
- triangle 90 cap reversed, 254
- triangle 90 reversed, 253
- \arrowreversed, 327
- arrows key, 157
- arrows library, 253
- arrows option, 157
- as node key, 398
- asin math function, 530
- aspect key, 316, 407, 421
- assume math mode key, 543
- asterisk plot mark, 398
- at key, 142, 171, 564
- at end key, 190
- at least date test, 506
- at most date test, 507
- at start key, 190
- atan math function, 530
- atan2 math function, 530
- \attribute, 548
- attribute key, 338
- auto key, 188
- auto corner on length key, 587
- auto end on length key, 587
- automata library, 255
- axiom key, 365
- axis shading, 399
- back key, 461
- background grid key, 261
- background rectangle key, 260
- background top key, 262
- \backgroundpath, 620
- backgrounds library, 260
- backward diode key, 308
- ball plot mark, 225
- ball shading, 399
- ball color key, 400
- bar interval shift key, 394
- bar interval width key, 394
- bar shift key, 394
- bar width key, 393
- barycentric coordinate system, 125
- base key, 564
- base left key, 186
- base right key, 186
- baseline key, 116
- battery key, 307
- battery IEC shape, 314
- before background key, 310, 311
- \beforebackgroundpath, 621
- \beforedecoration, 593
- \beforeforegroundpath, 621
- \beginpgfgraphicnamed, 642
- \behindbackgroundpath, 621
- \behindforegroundpath, 621
- .belongs to family handler, 496
- below key, 181, 184
- below delimiter key, 370
- below left key, 182, 185
- below right key, 182
- bend key, 145
- bend angle key, 454
- bend at end key, 146
- bend at start key, 146
- bend left key, 453
- bend pos key, 145
- bend right key, 454
- bent decoration, 318
- between date test, 507
- bilinear interpolation shading, 400
- bin math function, 533
- bk key, 461

boolean expected key, 493  
 border decoration, 320  
 bottom key, 564  
 bottom color key, 399  
 brace decoration, 320  
 break contact key, 308  
 break contact IEC shape, 315  
 breakdown diode key, 308  
 breakdown diode IEC shape, 312  
 \breakforeach, 504  
 bricks pattern, 384  
 buffer gate key, 299  
 buffer gate IEC symbol key, 303  
 bulb key, 307  
 bumps decoration, 319  
 butt cap arrow tip, 254  
 by key, 131  
  
 \c@pgf@counta, 666  
 \c@pgf@countb, 666  
 \c@pgf@countc, 666  
 \c@pgf@countd, 666  
 calc library, 133  
 \calendar, 263  
 calendar library, 263  
 callout absolute pointer key, 442  
 callout pointer arc key, 443  
 callout pointer end size key, 444  
 callout pointer segments key, 445  
 callout pointer shorten key, 442  
 callout pointer start size key, 444  
 callout pointer width key, 442  
 callout relative pointer key, 442  
 Cantor set decoration, 336  
 canvas coordinate system, 122  
 canvas polar coordinate system, 124  
 capacitor key, 307  
 capacitor IEC shape, 313  
 .cd handler, 485  
 ceil math function, 528  
 cells key, 203  
 center key, 335  
 chain default direction key, 280  
 \chainin, 283  
 chains library, 280  
 chamfered rectangle shape, 448  
 chamfered rectangle angle key, 448  
 chamfered rectangle corners key, 449  
 chamfered rectangle sep key, 449  
 chamfered rectangle xsep key, 449  
 chamfered rectangle ysep key, 449  
 checkerboard pattern, 384  
 checkerboard light gray pattern, 384  
 child path operation, 210  
 child anchor key, 218  
 children are tokens key, 386  
 circle path operation, 141  
 circle shape, 406  
 circle connection bar decoration, 376  
 circle connection bar key, 377  
 circle connection bar switch color key, 377  
 circle ee shape, 309  
 circle solidus shape, 436  
 circle split shape, 435  
  
 circle through key, 457  
 circle with fuzzy edge 10 percent fading, 348  
 circle with fuzzy edge 15 percent fading, 348  
 circle with fuzzy edge 20 percent fading, 348  
 circuit declare annotation key, 293  
 circuit declare symbol key, 289  
 circuit declare unit key, 293  
 circuit ee key, 304  
 circuit ee IEC key, 305  
 circuit handle symbol key, 290  
 circuit logic key, 296  
 circuit logic CDH key, 298  
 circuit logic IEC key, 296  
 circuit logic US key, 297  
 circuit symbol filled key, 295  
 circuit symbol lines key, 295  
 circuit symbol open key, 295  
 circuit symbol size key, 289  
 circuit symbol unit key, 289  
 circuit.ee.IEC library, 305  
 circuits key, 289  
 circuits library, 288  
 circuits.ee library, 304  
 circuits.logic library, 296  
 circuits.logic.CDH library, 297  
 circuits.logic.IEC library, 296  
 circuits.logic.US library, 297  
 circular drop shadow key, 404  
 circular glow key, 405  
 circular sector shape, 419  
 circular sector angle key, 419  
 class key, 110  
 Class signal  
     connect, 551  
     emit, 551  
     signal, 551  
 Class signal, 551  
 Classes  
     signal, 551  
 \clip, 153  
 clip key, 165  
 clockwise from key, 459  
 closepath code key, 322  
 cloud shape, 423  
 cloud callout shape, 444  
 cloud ignores aspect key, 424  
 cloud puff arc key, 423  
 cloud puffs key, 423  
 cm key, 250  
 .code handler, 487  
 .code 2 args handler, 488  
 .code args handler, 488  
 coil decoration, 319  
 color key, 154  
 color option option, 154  
 color wheel shading, 400  
 color wheel black center shading, 401  
 color wheel white center shading, 401  
 \colorcurrentmixin, 518  
 colored tokens key, 387  
 colormixin environment, 518  
 column *(number)* key, 203  
 column sep key, 201

- concept key, 372
- concept color key, 373, 374
- concept connection key, 375
- connect method, 551
- const plot key, 227
- const plot mark left key, 227
- const plot mark right key, 227
- contact key, 308
- continue branch key, 285
- continue chain key, 281
- controls key, 455
- \coordinate, 172
- coordinate path operation, 172
- Coordinate systems
  - barycentric, 125
  - canvas, 122
  - canvas polar, 124
  - node, 126
  - perpendicular, 129
  - tangent, 128
  - xy polar, 125
  - xyz, 123
  - xyz polar, 124
- copy shadow key, 403
- cos math function, 529
- cos path operation, 146
- cosec math function, 529
- cosh math function, 533
- cot math function, 530
- coulomb key, 308
- count key, 504
- counterclockwise from key, 459
- cross out shape, 446
- crosses decoration, 329
- crosshatch pattern, 384
- crosshatch dots pattern, 384
- crosshatch dots gray pattern, 384
- crosshatch dots light steel blue pattern, 384
- css key, 110
- current bounding box node, 615
- current direction key, 307
- current direction' key, 307
- current page node, 616
- current path bounding box node, 616
- current point is local key, 132
- current source key, 307
- curve to key, 452
- curveto decoration, 319
- curveto code key, 322
- cylinder shape, 420
- cylinder body fill key, 421
- cylinder end fill key, 421
- cylinder uses custom fill key, 421
  
- dart shape, 417
- dart tail angle key, 418
- dart tip angle key, 418
- dash pattern key, 156
- dash phase key, 156
- dashed key, 157
- data (data visualization), 466
- Data formats, *see* Formats
- Data visualization
  - data, 466
  
- datavisualization.formats.functions library, 469
- Date tests
  - all, 506
  - at least, 506
  - at most, 507
  - between, 507
  - day of month, 507
  - end of month, 507
  - equals, 506
  - Friday, 506
  - Monday, 506
  - Saturday, 506
  - Sunday, 506
  - Thursday, 506
  - Tuesday, 506
  - Wednesday, 506
  - weekend, 506
  - workday, 506
- dates key, 263
- day code key, 265
- day list downward key, 271
- day list left key, 272
- day list right key, 272
- day list upward key, 271
- day of month date test, 507
- day text key, 266
- day xshift key, 264
- day yshift key, 264
- .deactivate family handler, 496
- dec sep key, 541
- declare function key, 538
- decorate key, 243
- decorate path operation, 241
- \decoration, 593
- decoration key, 241
- Decorations
  - bent, 318
  - border, 320
  - brace, 320
  - bumps, 319
  - Cantor set, 336
  - circle connection bar, 376
  - coil, 319
  - crosses, 329
  - curveto, 319
  - expanding waves, 320
  - footprints, 328
  - Koch curve type 1, 335
  - Koch curve type 2, 336
  - Koch snowflake, 336
  - lineto, 317
  - markings, 323
  - moveto, 321
  - random steps, 317
  - saw, 318
  - shape backgrounds, 330
  - show path construction, 321
  - snake, 319
  - straight zigzag, 317
  - text along path, 333
  - ticks, 321
  - triangles, 330
  - waves, 321

- zigzag, 318
- decorations library, 241
- decorations module, 583
- decorations.footprints library, 328
- decorations.fractals library, 335
- decorations.markings library, 323
- decorations.pathmorphing library, 317
- decorations.pathreplacing library, 320
- decorations.shapes library, 329
- decorations.text library, 333
- .default handler, 487
- defined key, 498
- deg math function, 529
- delta angle key, 143
- densely dashed key, 157
- densely dotted key, 157
- depth math function, 534
- diamond arrow tip, 254
- diamond plot mark, 398
- diamond shape, 407
- diamond\* plot mark, 398
- diode key, 308
- direction ee arrow tip, 309
- direction ee shape, 309
- direction ee arrow key, 309
- direction info key, 308
- distance key, 454, 461
- distance from start key, 325
- div math function, 526
- divide math function, 526
- domain key, 222
- dots pattern, 384
- dotted key, 157
- double key, 159
- double arrow shape, 431
- double arrow head extend key, 431
- double arrow head indent key, 431
- double arrow tip angle key, 431
- double copy shadow key, 404
- double distance key, 159
- double distance between line centers key, 159
- double equal sign distance key, 159
- draft package option, 557, 638
- \draw, 153
- draw key, 154
- draw opacity key, 231
- drop shadow key, 403
  
- e math function, 527
- east fading, 348
- .ecode handler, 488
- .ecode 2 args handler, 488
- .ecode args handler, 488
- edge path operation, 195
- edge from parent key, 219
- edge from parent path operation, 218
- edge from parent fork down key, 460
- edge from parent fork left key, 460
- edge from parent fork right key, 460
- edge from parent fork up key, 460
- edge from parent path key, 218
- ellipse path operation, 142
- ellipse shape, 408
- ellipse callout shape, 443

- ellipse split shape, 437
- emit method, 551
- <empty>* path operation, 138
- empty number key, 356
- end angle key, 143
- end of month date test, 507
- end radius key, 316
- \endpgfgraphicnamed, 643
- entity key, 337
- Environments
  - colormixin, 518
  - pgfdecoration, 589, 592
  - pgfinterruptboundingbox, 562, 563
  - pgfinterruptpath, 561, 562
  - pgfinterruptpicture, 562
  - pgfkeysinterruptkeyfilter, 498
  - pgflowlevelscope, 634
  - pgfmetadecoration, 595
  - pgfonlayer, 653, 654
  - pgfpicture, 558, 560
  - pgfscope, 560, 561
  - pgftransparencygroup, 665
  - scope, 118
  - tikzfadingfrompicture, 233, 234
  - tikzpicture, 115, 117
- equal math function, 530
- equals date test, 506
- equals key, 497
- er library, 337
- /errors/
  - boolean expected, 493
  - unknown choice value, 493
  - unknown key, 493
  - value forbidden, 493
  - value required, 493
- escape key, 109
- .estore in handler, 491
- .estyle handler, 489
- .estyle 2 args handler, 489
- .estyle args handler, 489
- evaluate key, 503
- even odd rule key, 162
- every *<part name>* node part key, 176
- every *<shape>* node key, 172
- every above delimiter key, 370
- every accepting by arrow key, 258
- every annotation key, 379
- every attribute key, 338
- every below delimiter key, 370
- every calendar key, 263
- every cell key, 203
- every child key, 213
- every child node key, 213
- every circle key, 142
- every circle connection bar key, 377
- every circuit ee key, 304
- every circuit logic key, 296
- every circuit symbol key, 290
- every concept key, 372
- every cut key, 380
- every data key, 471
- every day (initially anchor key, 266
- every decoration key, 591

every delimiter key, 369  
 every edge (initially draw) key, 195  
 every entity key, 337  
 every even column key, 203  
 every even row key, 204  
 every extra concept key, 373  
 every fit key, 349  
 every fold key, 380  
 every info key, 292  
 every initial by arrow key, 257  
 every join key, 284  
 every label key, 193  
 every left delimiter key, 369  
 every loop key, 456  
 every mark key, 226  
 every matrix key, 199  
 every mindmap key, 371  
 every month key, 267  
 every node key, 171  
 every odd column key, 203  
 every odd row key, 204  
 every on chain key, 282  
 every path key, 138  
 every picture key, 117  
 every pin key, 193  
 every pin edge key, 193  
 every place key, 385  
 every plot key, 225  
 every relationship key, 338  
 every right delimiter key, 370  
 every scope key, 118  
 every shadow key, 403  
 every state key, 256  
 every to key, 148, 149  
 every token key, 386  
 every transition key, 385  
 every year key, 268  
 exec key, 493  
 execute after day scope key, 269  
 execute at begin cell key, 204  
 execute at begin day scope key, 269  
 execute at begin picture key, 116  
 execute at begin scope key, 118  
 execute at begin to key, 149  
 execute at empty cell key, 204  
 execute at end cell key, 204  
 execute at end day scope key, 269  
 execute at end picture key, 116  
 execute at end scope key, 118  
 execute before day scope key, 269  
 executed at end to key, 149  
 exp math function, 527  
 .expand once handler, 491  
 .expand twice handler, 492  
 .expanded handler, 492  
 expanding waves decoration, 320  
 export key, 343  
 export next key, 343  
 external library, 339  
 External Graphics  
     Bounding Box Issues, 346, 645  
 extra concept key, 373  
 face 1 key, 380  
 face 12 key, 380  
 face 2 key, 380  
 face 3 key, 380  
 factorial math function, 526  
 fading angle key, 236  
 fading transform key, 235  
 Fadings  
     circle with fuzzy edge 10 percent, 348  
     circle with fuzzy edge 15 percent, 348  
     circle with fuzzy edge 20 percent, 348  
     east, 348  
     fuzzy ring 15 percent, 348  
     north, 348  
     south, 348  
     west, 348  
 fadings library, 348  
 false key, 498  
 false math function, 531  
 farad key, 308  
 fast cap arrow tip, 254  
 fast cap reversed arrow tip, 254  
 fd key, 461  
 figure list key, 343  
 figure name key, 342  
 File, *see* Packages and files  
 \fill, 153  
 fill key, 160  
 fill opacity key, 232  
 \filldraw, 153  
 fit key, 349  
 fit library, 349  
 fit fading key, 235  
 fit to path key, 335  
 fit to path stretching spaces key, 335  
 fivepointed stars pattern, 384  
 fixed key, 539  
 fixed point arithmetic key, 352  
 fixed zerofill key, 539  
 fixedpointarithmetic library, 352  
 floor math function, 528  
 folding library, 380  
 folding line length key, 380  
 font key, 176  
 foot angle key, 328  
 foot length key, 328  
 foot of key, 328  
 foot sep key, 328  
 footprints decoration, 328  
 forbidden sign shape, 422  
 force remake key, 343  
 \foreach, 500  
 \foregroundpath, 620  
 format key, 471  
 Formats  
     function, 469  
     key value pairs, 468  
     table, 467  
     TeX code, 468  
 forward key, 461  
 fpu key, 354  
 fpu library, 354  
 frac math function, 528  
 framed key, 261

Friday date test, 506  
 function format, 469  
 fuzzy ring 15 percent fading, 348

general shadow key, 402  
 generic circle IEC shape, 310  
 generic diode IEC shape, 311  
 .get handler, 490  
 get handle method, 550  
 get id method, 550  
 Graphic options and styles  
   (*shape name*), 171  
   arrows, 157  
   color option, 154  
 greater math function, 530  
 grid path operation, 143  
 grid pattern, 384  
 gridded key, 261  
 ground key, 307  
 ground IEC shape, 314  
 grow key, 215  
 grow cyclic key, 459  
 grow via three points key, 458  
 grow' key, 216  
 growth function key, 217  
 growth parent anchor key, 217

/handler config/  
   only existing/  
     add exception, 483  
 handler config, 482  
 handler config key, 482  
 Handlers for keys, *see* Key handlers  
 headline key, 468  
 height math function, 534  
 help lines key, 145  
 henry key, 308  
 hertz key, 308  
 Hex math function, 532  
 hex math function, 532  
 home key, 461  
 hooks arrow tip, 253  
 hooks reversed arrow tip, 253  
 horizontal line through key, 129  
 horizontal lines pattern, 384  
 horizontal lines dark blue pattern, 384  
 horizontal lines dark gray pattern, 384  
 horizontal lines gray pattern, 384  
 horizontal lines light blue pattern, 384  
 horizontal lines light gray pattern, 384  
 how key, 461  
 huge circuit symbols key, 289  
 huge mindmap key, 372

id key, 110, 224  
 if key, 268  
 if input segment is closepath key, 587  
 \ifdate, 508  
 \ifpgfallowupsidedowattime, 632  
 \ifpgfrememberpicturepositiononpage, 560  
 \ifpgfresetnontranslationsattime, 632  
 \ifpgfslopedattime, 632  
 \ifpgfsys@eorule, 676  
 ifthenelse math function, 531

ignore key, 496  
 implies arrow tip, 253  
 in key, 452  
 in control key, 455  
 in distance key, 455  
 in looseness key, 454  
 in max distance key, 454  
 in min distance key, 454  
 include external key, 346, 645  
 inductor key, 307  
 inductor IEC shape, 313  
 info key, 292  
 info sloped key, 292  
 info' key, 292  
 info' sloped key, 293  
 \inheritanchor, 621  
 \inheritanchorborder, 621  
 \inheritbackgroundpath, 621  
 \inheritbeforebackgroundpath, 621  
 \inheritbeforeforegroundpath, 621  
 \inheritbehindbackgroundpath, 621  
 \inheritbehindforegroundpath, 621  
 \inheritforegroundpath, 621  
 \inheritssavedanchors, 621  
 .initial handler, 490  
 initial key, 256  
 initial above key, 257  
 initial below key, 257  
 initial by arrow key, 257  
 initial by diamond key, 257  
 initial left key, 257  
 initial right key, 257  
 initial text key, 257  
 initial where key, 257  
 inner color key, 401  
 inner frame sep key, 260  
 inner frame xsep key, 260  
 inner frame ysep key, 260  
 inner sep key, 172, 613  
 inner xsep key, 173, 613  
 inner ysep key, 173, 613  
 inputs key, 296, 298  
 insert path key, 138  
 install key, 345  
 .install key filter handler, 495  
 .install key filter handler handler, 495  
 int math function, 528  
 int detect key, 540  
 int trunc key, 540

Internals  
   \c@pgf@counta, 666  
   \c@pgf@countb, 666  
   \c@pgf@countc, 666  
   \c@pgf@countd, 666  
   \pgf@x, 666  
   \pgf@xa, 666  
   \pgf@xb, 666  
   \pgf@xc, 666  
   \pgf@y, 666  
   \pgf@ya, 666  
   \pgf@yb, 666  
   \pgf@yc, 666  
   \pgfutil@tempboxa, 667

- `\pgfutil@tempdima`, 666
- `\pgfutil@tempdimb`, 666
- `\w@pgf@writea`, 666
- intersections library, 130, 570
- intial distance key, 257, 258
- invalid number key, 356
- `.is` choice handler, 491
- is descendant of key, 497
- `.is` family handler, 485, 496
- `.is` if handler, 491
- isosceles triangle shape, 415
- isosceles triangle apex angle key, 415
- isosceles triangle stretches key, 415
  
- join key, 284
- jump mark left key, 228
- jump mark right key, 228
  
- key attribute key, 338
- Key handlers
  - `.activate` family, 496
  - `.add`, 490
  - `.add code`, 488
  - `.add style`, 489
  - `.append`, 490
  - `.append code`, 488
  - `.append style`, 490
  - `.belongs to` family, 496
  - `.cd`, 485
  - `.code`, 487
  - `.code 2 args`, 488
  - `.code args`, 488
  - `.deactivate` family, 496
  - `.default`, 487
  - `.ecode`, 488
  - `.ecode 2 args`, 488
  - `.ecode args`, 488
  - `.estore in`, 491
  - `.estyle`, 489
  - `.estyle 2 args`, 489
  - `.estyle args`, 489
  - `.expand once`, 491
  - `.expand twice`, 492
  - `.expanded`, 492
  - `.get`, 490
  - `.initial`, 490
  - `.install` key filter, 495
  - `.install` key filter handler, 495
  - `.is` choice, 491
  - `.is` family, 485, 496
  - `.is` if, 491
  - `.lastretry`, 492
  - `.link`, 490
  - `.prefix`, 490
  - `.prefix code`, 488
  - `.prefix style`, 490
  - `.retry`, 492
  - `.search` also, 485
  - `.show` code, 492
  - `.show` value, 492
  - `.store in`, 490
  - `.style`, 489
  - `.style 2 args`, 489
  - `.style args`, 489
- `.try`, 492
- `.value` forbidden, 487
- `.value` required, 487
- key value pairs format, 468
- kite shape, 416
- kite lower vertex angle key, 416
- kite upper vertex angle key, 416
- kite vertex angles key, 416
- Koch curve type 1 decoration, 335
- Koch curve type 2 decoration, 336
- Koch snowflake decoration, 336
  
- l-system key, 365
- l-system path operation, 365
- label key, 191
- label distance key, 193
- label position key, 191
- large circuit symbols key, 289
- large mindmap key, 372
- `.lastretry` handler, 492
- late options key, 198
- latex arrow tip, 253, 609
- latex reversed arrow tip, 253, 609
- latex' arrow tip, 253
- latex' reversed arrow tip, 253
- Layout, *see* Page layout
- left key, 181, 184, 334, 462, 563
- left angle key, 363
- left color key, 399
- left delimiter key, 369
- left hook arrow tip, 254
- left hook reversed arrow tip, 254
- left indent key, 335
- left to arrow tip, 254
- left to reversed arrow tip, 254
- less math function, 530
- let path operation, 149
- level key, 213
- level 1 concept key, 373
- level 2 concept key, 374
- level 3 concept key, 374
- level 4 concept key, 374
- level  $\langle$ number $\rangle$  key, 213
- level distance key, 214
- Libraries
  - arrows, 253
  - automata, 255
  - backgrounds, 260
  - calc, 133
  - calendar, 263
  - chains, 280
  - circuit.ee.IEC, 305
  - circuits, 288
  - circuits.ee, 304
  - circuits.logic, 296
  - circuits.logic.CDH, 297
  - circuits.logic.IEC, 296
  - circuits.logic.US, 297
  - datavisualization.formats.functions, 469
  - decorations, 241
  - decorations.footprints, 328
  - decorations.fractals, 335
  - decorations.markings, 323
  - decorations.pathmorphing, 317

- decorations.pathreplacing, 320
- decorations.shapes, 329
- decorations.text, 333
- er, 337
- external, 339
- fadings, 348
- fit, 349
- fixedpointarithmetic, 352
- folding, 380
- fpu, 354
- intersections, 130, 570
- lindenmayersystems, 362
- matrix, 367
- mindmap, 371
- patterns, 384
- petri, 385
- plothandlers, 390
- plotmarks, 398
- positioning, 182
- scopes, 118
- shadings, 399
- shadows, 402
- shapes.arrows, 429
- shapes.callout, 441
- shapes.gates.ee, 308
- shapes.gates.ee.IEC, 310
- shapes.gates.logic, 299
- shapes.gates.logic.IEC, 302
- shapes.gates.logic.US, 300
- shapes.geometric, 407
- shapes.misc, 445
- shapes.multipart, 435
- shapes.symbols, 422
- svg.path, 451
- through, 457
- topaths, 452
- trees, 458
- turtle, 461
- light dependent key, 308
- light emitting key, 306, 308
- lindenmayer system key, 365
- lindenmayer system path operation, 365
- lindenmayersystems library, 362
- line cap key, 155
- line join key, 156
- line to key, 452
- line width key, 155
- lineto decoration, 317
- lineto code key, 322
- .link handler, 490
- ln math function, 527
- local bounding box key, 616
- log key, 496
- log10 math function, 527
- log2 math function, 527
- logic gate anchors use bounding box key, 301
- logic gate IEC symbol align key, 303
- logic gate IEC symbol color key, 303
- logic gate input sep key, 300
- logic gate inputs key, 299
- logic gate inverted radius key, 300
- loop key, 455
- loop above key, 455
- loop below key, 455
- loop left key, 455
- loop right key, 455
- loose background key, 260
- loosely dashed key, 157
- loosely dotted key, 157
- looseness key, 454
- lower left key, 400
- lt key, 462
- make contact key, 308
- make contact IEC shape, 314
- Mandelbrot set shading, 401
- mark key, 225, 324, 325
- mark connection node key, 327
- mark indices key, 225
- mark options key, 226
- mark phase key, 225
- mark repeat key, 225
- mark size key, 226
- markings decoration, 323
- Math functions
  - abs, 527
  - acos, 530
  - add, 526
  - and, 531
  - array, 533
  - asin, 530
  - atan, 530
  - atan2, 530
  - bin, 533
  - ceil, 528
  - cos, 529
  - cosec, 529
  - cosh, 533
  - cot, 530
  - deg, 529
  - depth, 534
  - div, 526
  - divide, 526
  - e, 527
  - equal, 530
  - exp, 527
  - factorial, 526
  - false, 531
  - floor, 528
  - frac, 528
  - greater, 530
  - height, 534
  - Hex, 532
  - hex, 532
  - ifthenelse, 531
  - int, 528
  - less, 530
  - ln, 527
  - log10, 527
  - log2, 527
  - max, 533
  - min, 533
  - Mod, 528
  - mod, 527
  - multiply, 526
  - neg, 526
  - not, 531



- notequal, 531
- notgreater, 531
- notless, 531
- oct, 532
- or, 531
- pi, 529
- pow, 527
- rad, 529
- rand, 532
- random, 532
- real, 528
- rnd, 532
- round, 528
- sec, 529
- sin, 529
- sinh, 533
- sqrt, 526
- subtract, 526
- tan, 529
- tanh, 533
- true, 531
- veclen, 533
- width, 534
- Math operators
  - ( ), 524
  - \*, 524
  - ||, 524
  - +, 523
  - , 524
  - /, 524
  - <, 524
  - <=, 524
  - ==, 524
  - >, 524
  - >=, 524
  - ? :, 524
  - [ ], 525
  - ~, 524
  - { }, 525
  - &&, 524
  - r, 524
- \matrix, 199
- matrix key, 199
- matrix library, 367
- matrix module, 623
- matrix anchor key, 205
- matrix of math nodes key, 368
- matrix of nodes key, 367
- max math function, 533
- max distance key, 454
- medium circuit symbols key, 289
- meta-amplitude key, 316
- meta-segment length key, 316
- \method, 547
- Methods
  - connect, 551
  - emit, 551
  - get handle, 550
  - get id, 550
  - signal, 551
- mid left key, 186
- mid right key, 186
- middle color key, 399
- midway key, 190
- min math function, 533
- min distance key, 454
- min exponent for 1000 sep key, 542
- mindmap key, 371
- mindmap library, 371
- minimum height key, 173, 613
- minimum size key, 174, 613
- minimum width key, 173, 613
- mirror key, 244
- missing key, 217
- miter limit key, 156
- Mod math function, 528
- mod math function, 527
- mode key, 344
- Modules
  - decorations, 583
  - matrix, 623
  - oo, 545
  - parser, 519
  - plot, 649
  - shapes, 610
- Monday date test, 506
- month code key, 267
- month label above centered key, 275
- month label above left key, 274
- month label above right key, 275
- month label below centered key, 276
- month label below left key, 275
- month label left key, 273
- month label left vertical key, 274
- month label right key, 274
- month label right vertical key, 274
- month list key, 273
- month text key, 267
- month xshift key, 264
- month yshift key, 264
- move to key, 452
- moveto decoration, 321
- moveto code key, 322
- multiply math function, 526
- \n, 149
- name key, 126, 131, 170, 234, 242, 365
- name intersections key, 130
- name path key, 130
- nand gate key, 299
- nand gate IEC shape, 303
- nand gate IEC symbol key, 302
- nand gate US shape, 301
- near end key, 190
- near start key, 190
- nearly opaque key, 232
- nearly transparent key, 232
- neg math function, 526
- next state key, 587, 593
- Node, *see* Predefined node
- \node, 172
- node coordinate system, 126
- node key, 128
- node path operation, 170
- node distance key, 184
- node halign header key, 179
- \nodepart, 175

- \nodeparts, 617
- nodes key, 203
- nodes in empty cells key, 368
- nonzero rule key, 161
- nor gate key, 299
- nor gate IEC symbol key, 302
- north fading, 348
- north east lines pattern, 384
- north west lines pattern, 384
- not key, 497
- not math function, 531
- not gate key, 299
- not gate IEC symbol key, 302
- notequal math function, 531
- notgreater math function, 531
- notless math function, 531
  
- o arrow tip, 254
- o plot mark, 398
- oct math function, 532
- of key, 130
- ohm key, 306, 308
- on chain key, 281
- on grid key, 183
- only marks key, 230
- only named key, 346
- oo module, 545
- opacity key, 231
- opaque key, 232
- open diamond arrow tip, 254
- open square arrow tip, 254
- open triangle 45 arrow tip, 253
- open triangle 45 reversed arrow tip, 253
- open triangle 60 arrow tip, 253
- open triangle 60 reversed arrow tip, 253
- open triangle 90 arrow tip, 253
- open triangle 90 reversed arrow tip, 253
- oplus plot mark, 398
- oplus\* plot mark, 398
- optimize key, 345
- optimize command away key, 345
- Options for graphics, *see* Graphic options and styles
- Options for packages, *see* Package options
- or key, 498
- or math function, 531
- or gate key, 299
- or gate IEC symbol key, 302
- order key, 365
- otimes plot mark, 398
- otimes\* plot mark, 398
- out key, 452
- out control key, 455
- out distance key, 455
- out looseness key, 454
- out max distance key, 454
- out min distance key, 454
- outer color key, 401
- outer frame sep key, 261
- outer frame xsep key, 261
- outer frame ysep key, 261
- outer sep key, 173, 614
- outer xsep key, 173, 613
- outer ysep key, 173, 614
- output format key, 354
  
- overlay key, 196
  
- \p, 150
- Package options for PGF
  - draft, 557, 638
  - version=*(version)*, 557
- Packages and files
  - pgf, 557
  - pgf.cfg, 671
  - pgfcalendar, 505
  - pgfcore, 557
  - pgfexternal.tex, 644
  - pgffor, 500
  - pgfkeys, 477
  - pgfmath, 521
  - pgfsys, 671
  - pgfsys-common-pdf, 671
  - pgfsys-common-postscript, 671
  - pgfsys-dvi.def, 110
  - pgfsys-dvipdfm.def, 108
  - pgfsys-dvips.def, 108
  - pgfsys-pdftex.def, 107
  - pgfsys-tex4ht.def, 109
  - pgfsys-textures.def, 108
  - pgfsys-vtex.def, 108
  - pgfsys-xetex.def, 108
  - tikz, 115
- Page layouts
  - 16 on 1, 513
  - 2 on 1, 513
  - 4 on 1, 513
  - 8 on 1, 513
  - resize to, 512
  - rounded corners, 513
  - two screens with lagging second, 514
  - two screens with optional second, 514
- parabola path operation, 145
- parabola height key, 146
- parametric key, 224
- parent anchor key, 218
- parser module, 519
- \path, 137
- path fading key, 235
- path has corners key, 316
- Path operations
  - , 139
  - |, 139
  - |-, 139
  - cycle, 140
  - plot, 220
  - .., 139
  - arc, 143
  - child, 210
  - circle, 141
  - coordinate, 172
  - cos, 146
  - decorate, 241
  - edge, 195
  - edge from parent, 218
  - ellipse, 142
  - (empty)*, 138
  - grid, 143
  - l-system, 365
  - let, 149

- lindenmayer system, 365
- node, 170
- parabola, 145
- plot, 220
- rectangle, 140
- sin, 146
- svg, 147
- to, 147

path picture key, 162

path picture bounding box node, 163

\pattern, 153

pattern key, 160

pattern color key, 161

Patterns

- bricks, 384
- checkerboard, 384
- checkerboard light gray, 384
- crosshatch, 384
- crosshatch dots, 384
- crosshatch dots gray, 384
- crosshatch dots light steel blue, 384
- dots, 384
- fivepointed stars, 384
- grid, 384
- horizontal lines, 384
- horizontal lines dark blue, 384
- horizontal lines dark gray, 384
- horizontal lines gray, 384
- horizontal lines light blue, 384
- horizontal lines light gray, 384
- north east lines, 384
- north west lines, 384
- sixpointed stars, 384
- vertical lines, 384

patterns library, 384

pentagon plot mark, 398

pentagon\* plot mark, 398

perpendicular coordinate system, 129

persistent postcomputation key, 587

persistent precomputation key, 587

petri library, 385

/pgf/

- and gate IEC symbol, 302
- arrow box arrows, 433
- arrow box east arrow, 433
- arrow box head extend, 433
- arrow box head indent, 433
- arrow box north arrow, 433
- arrow box shaft width, 433
- arrow box south arrow, 433
- arrow box tip angle, 432
- arrow box west arrow, 433
- aspect, 407, 421
- bar interval shift, 394
- bar interval width, 394
- bar shift, 394
- bar width, 393
- buffer gate IEC symbol, 303
- callout absolute pointer, 442
- callout pointer arc, 443
- callout pointer end size, 444
- callout pointer segments, 445
- callout pointer shorten, 442
- callout pointer start size, 444
- callout pointer width, 442
- callout relative pointer, 442
- chamfered rectangle angle, 448
- chamfered rectangle corners, 449
- chamfered rectangle sep, 449
- chamfered rectangle xsep, 449
- chamfered rectangle ysep, 449
- circular sector angle, 419
- cloud ignores aspect, 424
- cloud puff arc, 423
- cloud puffs, 423
- cylinder body fill, 421
- cylinder end fill, 421
- cylinder uses custom fill, 421
- dart tail angle, 418
- dart tip angle, 418
- data/
  - format, 471
  - headline, 468
  - samples, 469
  - separator, 468
  - source, 470
- declare function, 538
- decoration/
  - amplitude, 316
  - anchor, 330
  - angle, 316
  - aspect, 316
  - closepath code, 322
  - curveto code, 322
  - end radius, 316
  - foot angle, 328
  - foot length, 328
  - foot of, 328
  - foot sep, 328
  - lineto code, 322
  - mark, 324, 325
  - mark connection node, 327
  - meta-amplitude, 316
  - meta-segment length, 316
  - mirror, 244
  - moveto code, 322
  - name, 242
  - path has corners, 316
  - pre, 244
  - pre length, 245
  - radius, 316
  - raise, 243
  - reset marks, 326
  - reverse path, 334
  - segment length, 316
  - shape, 331
  - shape end height, 333
  - shape end size, 333
  - shape end width, 332
  - shape evenly spread, 331
  - shape height, 329
  - shape scaled, 332
  - shape sep, 331
  - shape size, 329
  - shape sloped, 331
  - shape start height, 332

- shape start size, 332
- shape start width, 332
- shape width, 329
- start radius, 316
- stride length, 328
- text, 333
- text align, 334
- text color, 334
- text format delimiters, 334
- transform, 244
- decoration, 241
- decoration automaton/
  - auto corner on length, 587
  - auto end on length, 587
  - if input segment is closepath, 587
  - next state, 587
  - persistent postcomputation, 587
  - persistent precomputation, 587
  - repeat state, 587
  - switch if input segment less than, 586
  - switch if less than, 586
  - width, 586
- decorations/
  - post, 245
  - post length, 245
- direction ee arrow, 309
- double arrow head extend, 431
- double arrow head indent, 431
- double arrow tip angle, 431
- every data, 471
- every decoration, 591
- fixed point/
  - scale file plot x, 353
  - scale file plot y, 353
  - scale file plot z, 353
  - scale results, 352
- fixed point arithmetic, 352
- foreach/
  - count, 504
  - evaluate, 503
  - remember, 504
  - var, 503
- fpu/
  - output format, 354
  - scale file plot x, 355
  - scale file plot y, 355
  - scale file plot z, 355
  - scale results, 355
- fpu, 354
- generic circle IEC/
  - before background, 310
- generic diode IEC/
  - before background, 311
- images/
  - include external, 346, 645
- inner sep, 172, 613
- inner xsep, 173, 613
- inner ysep, 173, 613
- isosceles triangle apex angle, 415
- isosceles triangle stretches, 415
- key filter handlers/
  - append filtered to, 495
  - ignore, 496
  - log, 496
- key filters/
  - active families, 496
  - active families or no family, 496
  - active families or no family DEBUG, 497
  - and, 498
  - defined, 498
  - equals, 497
  - false, 498
  - is descendant of, 497
  - not, 497
  - or, 498
  - true, 498
- kite lower vertex angle, 416
- kite upper vertex angle, 416
- kite vertex angles, 416
- l-system, 365
- lindenmayer system/
  - anchor, 366
  - axiom, 365
  - left angle, 363
  - name, 365
  - order, 365
  - randomize angle percent, 363
  - randomize step percent, 363
  - right angle, 363
  - rule set, 365
  - step, 363
- lindenmayer system, 365
- local bounding box, 616
- logic gate anchors use bounding box, 301
- logic gate IEC symbol align, 303
- logic gate IEC symbol color, 303
- logic gate input sep, 300
- logic gate inputs, 299
- logic gate inverted radius, 300
- meta-decoration automaton/
  - next state, 593
  - switch if less than, 593
  - width, 593
- minimum height, 173, 613
- minimum size, 174, 613
- minimum width, 173, 613
- nand gate IEC symbol, 302
- nor gate IEC symbol, 302
- not gate IEC symbol, 302
- number format/
  - 1000 sep, 541
  - assume math mode, 543
  - dec sep, 541
  - fixed, 539
  - fixed zerofill, 539
  - int detect, 540
  - int trunc, 540
  - min exponent for 1000 sep, 542
  - precision, 540
  - print sign, 543
  - sci, 539
  - sci 10<sup>e</sup>, 543
  - sci 10e, 543
  - sci E, 543
  - sci e, 543
  - sci subscript, 543

- sci superscript, 543
- sci zerofill, 540
- set decimal separator, 541
- set thousands separator, 541
- showpos, 543
- skip 0., 542
- std, 540
- use comma, 542
- use period, 542
- zerofill, 540
- or gate IEC symbol, 302
- outer sep, 173, 614
- outer xsep, 173, 613
- outer ysep, 173, 614
- random starburst, 425
- rectangle split allocate boxes, 438
- rectangle split draw splits, 440
- rectangle split empty part depth, 439
- rectangle split empty part height, 439
- rectangle split empty part width, 439
- rectangle split horizontal, 439
- rectangle split ignore empty parts, 439
- rectangle split part align, 439
- rectangle split part fill, 440
- rectangle split parts, 439
- rectangle split use custom fill, 440
- regular polygon sides, 412
- rounded rectangle arc length, 447
- rounded rectangle east arc, 448
- rounded rectangle left arc, 448
- rounded rectangle right arc, 448
- rounded rectangle west arc, 447
- shape aspect, 174
- shape border rotate, 175
- shape border uses incircle, 175
- signal from, 427
- signal pointer angle, 427
- signal to, 427
- single arrow head extend, 430
- single arrow head indent, 430
- single arrow tip angle, 430
- star point height, 414
- star point ratio, 414
- star points, 414
- starburst point height, 425
- starburst points, 425
- step, 578
- stepx, 578
- stepy, 578
- tape bend bottom, 428
- tape bend height, 428
- tape bend top, 428
- text/
  - at, 564
  - base, 564
  - bottom, 564
  - left, 563
  - right, 563
  - rotate, 564
  - x, 564
  - y, 564
- text mark/
  - as node, 398
  - style, 398
  - text mark, 398
  - trapezium angle, 409
  - trapezium left angle, 409
  - trapezium right angle, 409
  - trapezium stretches, 410
  - trapezium stretches body, 410
  - xnor gate IEC symbol, 302
  - xor gate IEC symbol, 302
- pgf package, 557
- pgf.cfg file, 671
- \pgf@pathmaxx, 581
- \pgf@pathmaxy, 581
- \pgf@pathminx, 581
- \pgf@pathminy, 581
- \pgf@picmaxx, 581
- \pgf@picmaxy, 582
- \pgf@picminx, 581
- \pgf@picminy, 582
- \pgf@process, 572
- \pgf@protocolsizes, 582
- \pgf@relevantforpicturesizefalse, 582
- \pgf@relevantforpicturesizetrue, 582
- \pgf@sys@bp, 682
- \pgf@x, 666
- \pgf@xa, 666
- \pgf@xb, 666
- \pgf@xc, 666
- \pgf@y, 666
- \pgf@ya, 666
- \pgf@yb, 666
- \pgf@yc, 666
- \pgfaliasimage, 639
- \pgfalternateextension, 639
- \pgffarrowsdeclare, 603
- \pgffarrowsdeclarealias, 607
- \pgffarrowsdeclarecombine, 608
- \pgffarrowsdeclaredouble, 608
- \pgffarrowsdeclarereversed, 607
- \pgffarrowsdeclaretriple, 608
- \pgfcalendar, 508
- pgfcalendar package, 505
- \pgfcalendaratetojulian, 505
- \pgfcalendarifdate, 506
- \pgfcalendarjuliantodate, 506
- \pgfcalendarjuliantoweekday, 506
- \pgfcalendarmonthname, 507
- \pgfcalendarmonthshortname, 508
- \pgfcalendarshorthand, 510
- \pgfcalendarsuggestedname, 510
- \pgfcalendarweekdayname, 507
- \pgfcalendarweekdayshortname, 507
- \pgfcoordinate, 612
- pgfcore package, 557
- \pgfdata, 470
- \pgfdeclaredataformat, 472
- \pgfdeclaredecoration, 585
- \pgfdeclarefading, 663
- \pgfdeclarefunctionalshading, 656
- \pgfdeclarehorizontalshading, 655
- \pgfdeclareimage, 638
- \pgfdeclarelayer, 653
- \pgfdeclarelindenmayersystem, 362

- \pgfdeclaremask, 640
- \pgfdeclaremetadecorate, 593
- \pgfdeclarepatternformonly, 635
- \pgfdeclarepatterninherentlycolored, 636
- \pgfdeclareplotmark, 396
- \pgfdeclareradialshading, 656
- \pgfdeclareshape, 617
- \pgfdeclareverticalshading, 656
- \pgfdecorateaftercode, 592
- \pgfdecoratebeforecode, 592
- \pgfdecoratecurrentpath, 592
- \pgfdecoratedangle, 588
- \pgfdecoratedcompleteddistance, 588
- \pgfdecoratedinputsegmentcompleteddistance, 588
- \pgfdecoratedinputsegmentlength, 588
- \pgfdecoratedinputsegmentremainingdistance, 588
- \pgfdecoratedpath, 591
- \pgfdecoratedpathlength, 587
- \pgfdecoratedremainingdistance, 588
- \pgfdecorateexistingpath, 591
- \pgfdecoratepath, 592
- pgfdecoration environment, 589, 592
- \pgfdecorationpath, 591
- pgfexternal.tex file, 644
- \pgfextra, 151, 152
- \pgfextractx, 571
- \pgfextracty, 571
- pgffor package, 500
- \pgfgetarrowoptions, 607
- \pgfgettransform, 633
- \pgfimage, 640
- pgfinterruptboundingbox environment, 562, 563
- pgfinterruptpath environment, 561, 562
- pgfinterruptpicture environment, 562
- \pgfintersectionofpaths, 570
- \pgfintersectionsolutions, 571
- \pgfintersectionsortbyfirstpath, 571
- \pgfintersectionsorthysecondpath, 571
- \pgfkeys, 480
- pgfkeys package, 477
- \pgfkeysactivatefamilies, 498
- \pgfkeysactivatefamiliesandfilteroptions, 497
- \pgfkeysactivatefamily, 498
- \pgfkeysactivatesinglefamilyandfilteroptions, 497
- \pgfkeysalso, 480
- \pgfkeysalsofiltered, 495
- \pgfkeysalsofilteredfrom, 495
- \pgfkeysalsofrom, 494
- \pgfkeysdeactivatefamily, 498
- \pgfkeysdef, 481
- \pgfkeysdefargs, 481
- \pgfkeysedef, 481
- \pgfkeysedefargs, 481
- \pgfkeysevalkeyfilterwith, 499
- \pgfkeysfiltered, 494
- \pgfkeysgetfamily, 499
- \pgfkeysgetvalue, 479
- \pgfkeysifdefined, 479
- \pgfkeysiffamilydefined, 499
- \pgfkeysinstallkeyfilter, 498
- \pgfkeysinstallkeyfilterhandler, 498
- pgfkeysinterruptkeyfilter environment, 498
- \pgfkeysisfamilyactive, 499
- \pgfkeyslet, 479
- \pgfkeys savekeyfilterstateto, 498
- \pgfkeyssetdefaultpathforhandled, 483
- \pgfkeyssetvalue, 479
- \pgfkeysvalueof, 479
- \pgflibraryfpuiactive, 355
- \pgflindenmeyersystem, 364
- \pgflinewidth, 597
- \pgflowlevel, 633
- \pgflowlevelobj, 634
- pgflowlevelscope environment, 634
- \pgflowlevelsynccm, 633
- \pgflsystemcurrentleftangle, 363
- \pgflsystemcurrentrightangle, 363
- \pgflsystemcurrentstep, 363
- \pgflsystemdrawforward, 364
- \pgflsystemmoveforward, 364
- \pgflsystemrandomizeleftangle, 363
- \pgflsystemrandomizerightangle, 363
- \pgflsystemrandomizestep, 363
- \pgflsystemrestorestate, 364
- \pgflsystemsavestate, 364
- \pgflsystemturnleft, 364
- \pgflsystemturnright, 364
- pgfmath package, 521
- \pgfmathabs, 527
- \pgfmathacos, 530
- \pgfmathadd, 526
- \pgfmathaddtcount, 523
- \pgfmathaddtcounter, 523
- \pgfmathaddtolength, 523
- \pgfmathand, 531
- \pgfmathapproxeto, 535
- \pgfmatharray, 533
- \pgfmathasin, 530
- \pgfmathatan, 530
- \pgfmathatantwo, 530
- \pgfmathbasetoBase, 536
- \pgfmathbasetobase, 536
- \pgfmathbasetodec, 536
- \pgfmathbin, 533
- \pgfmathceil, 528
- \pgfmathcos, 529
- \pgfmathcosec, 530
- \pgfmathcosh, 533
- \pgfmathcot, 530
- \pgfmathdeclarefunction, 537
- \pgfmathdeclarerandomlist, 535
- \pgfmathdectoBase, 536
- \pgfmathdectobase, 536
- \pgfmathdeg, 529
- \pgfmathdepth, 534
- \pgfmathdiv, 526
- \pgfmathdivide, 526
- \pgfmathe, 527
- \pgfmathequal, 530
- \pgfmathexp, 527
- \pgfmathfactorial, 526
- \pgfmathfalse, 531
- \pgfmathfloatabs, 360
- \pgfmathfloatabserror, 357
- \pgfmathfloatadd, 360

`\pgfmathfloatcreate`, 357  
`\pgfmathfloatdivide`, 360  
`\pgfmathfloatgetexponent`, 357  
`\pgfmathfloatgetflags`, 357  
`\pgfmathfloatgetmantisse`, 357  
`\pgfmathfloatgetmantissetok`, 357  
`\pgfmathfloatint`, 358  
`\pgfmathfloatlessthan`, 360  
`\pgfmathfloatmax`, 360  
`\pgfmathfloatmin`, 360  
`\pgfmathfloatmultiply`, 360  
`\pgfmathfloatmultiplyfixed`, 360  
`\pgfmathfloatparsenumber`, 355  
`\pgfmathfloatqparsenumber`, 356  
`\pgfmathfloatreerror`, 357  
`\pgfmathfloatround`, 359  
`\pgfmathfloatroundzerofill`, 359  
`\pgfmathfloatsetextprecision`, 358  
`\pgfmathfloatshift`, 357  
`\pgfmathfloatsqrt`, 360  
`\pgfmathfloatsubtract`, 360  
`\pgfmathfloattoextendedprecision`, 358  
`\pgfmathfloattofixed`, 356  
`\pgfmathfloattomacro`, 357  
`\pgfmathfloattoregisters`, 357  
`\pgfmathfloattoregisterstok`, 357  
`\pgfmathfloattosci`, 357  
`\pgfmathfloor`, 528  
`\pgfmathfrac`, 528  
`\pgfmathgeneratepseudorandomnumber`, 535  
`\pgfmathgreater`, 530  
`\pgfmathheight`, 534  
`\pgfmathHex`, 532  
`\pgfmathhex`, 532  
`\pgfmathifthenelse`, 531  
`\pgfmathint`, 528  
`\pgfmathless`, 530  
`\pgfmathln`, 527  
`\pgfmathlog`, 359  
`\pgfmathlogten`, 527  
`\pgfmathlogtwo`, 527  
`\pgfmathmax`, 533  
`\pgfmathmin`, 533  
`\pgfmathMod`, 528  
`\pgfmathmod`, 528  
`\pgfmathmultiply`, 526  
`\pgfmathneg`, 526  
`\pgfmathnot`, 531  
`\pgfmathnotequal`, 531  
`\pgfmathnotgreater`, 531  
`\pgfmathnotless`, 531  
`\pgfmathoct`, 532  
`\pgfmathor`, 531  
`\pgfmathparse`, 522  
`\pgfmathpi`, 529  
`\pgfmathpostparse`, 523  
`\pgfmathpow`, 527  
`\pgfmathprintnumber`, 539  
`\pgfmathprintnumberto`, 539  
`\pgfmathqparse`, 522  
`\pgfmathrad`, 529  
`\pgfmathrand`, 532  
`\pgfmathrandom`, 532  
`\pgfmathrandominteger`, 535  
`\pgfmathrandomitem`, 535  
`\pgfmathreal`, 528  
`\pgfmathreciprocal`, 535  
`\pgfmathredeclarefunction`, 538  
`\pgfmathrnd`, 532  
`\pgfmathround`, 528  
`\pgfmathroundto`, 358  
`\pgfmathroundtozerofill`, 358  
`\pgfmathsec`, 529  
`\pgfmathsetbasenumberlength`, 536  
`\pgfmathsetcount`, 523  
`\pgfmathsetcounter`, 523  
`\pgfmathsetlength`, 523  
`\pgfmathsetlengthmacro`, 523  
`\pgfmathsetmacro`, 523  
`\pgfmathsetseed`, 536  
`\pgfmathsin`, 529  
`\pgfmathsinh`, 533  
`\pgfmathsqrt`, 526  
`\pgfmathsubtract`, 526  
`\pgfmathtan`, 529  
`\pgfmathtanh`, 533  
`\pgfmathtrue`, 531  
`\pgfmathtruncatemacro`, 523  
`\pgfmathveclen`, 533  
`\pgfmathwidth`, 534  
`\pgfmatrix`, 623  
`\pgfmatrixbegincode`, 627  
`\pgfmatrixcurrentcolumn`, 627  
`\pgfmatrixcurrentrow`, 627  
`\pgfmatrixemptycode`, 627  
`\pgfmatrixendcode`, 627  
`\pgfmatrixendrow`, 626  
`\pgfmatrixnextcell`, 625  
`\pgfmetadecoratedcompleteddistance`, 594  
`\pgfmetadecoratedinputsegmentcompleteddistance`, 594  
`\pgfmetadecoratedinputsegmentremainingdistance`, 594  
`\pgfmetadecoratedpathlength`, 593  
`\pgfmetadecoratedremainingdistance`, 594  
`pgfmetadecoration environment`, 595  
`\pgfmultipartnode`, 612  
`\pgfnode`, 611  
`\pgfnodealias`, 612  
`pgfonlayer environment`, 653, 654  
`\pgfooclass`, 545  
`\pgfoogc`, 547  
`\pgfooget`, 549  
`\pgfoolet`, 549  
`\pgfoonew`, 546  
`\pgfoobj`, 550  
`\pgfooset`, 549  
`\pgfoothis`, 548  
`\pgfoovalueof`, 549  
`\pgfpagescurrentpagewillbelogicalpage`, 517  
`\pgfpagesdeclarelayout`, 514  
`\pgfpageslogicalpageoptions`, 516  
`\pgfpagesphysicalpageoptions`, 515  
`\pgfpagesshipoutlogicalpage`, 517  
`\pgfpagesuselayout`, 512  
`\pgfparserdef`, 519

`\pgfparserparse`, 519  
`\pgfparserswitch`, 519  
`\pgfpatharc`, 576  
`\pgfpatharcaxes`, 576  
`\pgfpatharcto`, 576  
`\pgfpathcircle`, 578  
`\pgfpathclose`, 575  
`\pgfpathcosine`, 580  
`\pgfpathcurvebetweentime`, 575  
`\pgfpathcurvebetweentimecontinue`, 575  
`\pgfpathcurveto`, 574  
`\pgfpathellipse`, 577  
`\pgfpathgrid`, 578  
`\pgfpathlineto`, 574  
`\pgfpathmoveto`, 573  
`\pgfpathparabola`, 579  
`\pgfpathqcircle`, 669  
`\pgfpathqcurveto`, 668  
`\pgfpathqlineto`, 668  
`\pgfpathqmoveto`, 668  
`\pgfpathquadraticcurveto`, 575  
`\pgfpathrectangle`, 578  
`\pgfpathrectanglecorners`, 578  
`\pgfpathsine`, 579  
`\pgfpathsvg`, 451  
`pgfpicture` environment, 558, 560  
`\pgfplotbarwidth`, 394  
`\pgfplotfunction`, 650  
`\pgfplotgnuplot`, 651  
`\pgfplothandlerclosedcurve`, 390  
`\pgfplothandlerconstantlineto`, 391  
`\pgfplothandlerconstantlinetomarkright`, 391  
`\pgfplothandlercurveto`, 390  
`\pgfplothandlerdiscard`, 652  
`\pgfplothandlerjumpmarkleft`, 391  
`\pgfplothandlerjumpmarkright`, 391  
`\pgfplothandlerlineto`, 651  
`\pgfplothandlermark`, 395  
`\pgfplothandlermarklisted`, 395  
`\pgfplothandlerpolarcomb`, 392  
`\pgfplothandlerrecord`, 652  
`\pgfplothandlerrxbar`, 393  
`\pgfplothandlerrxbarinterval`, 394  
`\pgfplothandlerxcomb`, 392  
`\pgfplothandlerybar`, 393  
`\pgfplothandlerybarinterval`, 394  
`\pgfplothandlerycomb`, 392  
`\pgfplotmarksize`, 397  
`\pgfplotstreamend`, 649  
`\pgfplotstreampoint`, 649  
`\pgfplotstreamstart`, 649  
`\pgfplotxyfile`, 650  
`\pgfplotxyzfile`, 650  
`\pgfplotxzerolevelstreamconstant`, 393  
`\pgfplotyzerolevelstreamconstant`, 393  
`\pgfpoint`, 565  
`\pgfpointadd`, 567  
`\pgfpointanchor`, 614  
`\pgfpointborderellipse`, 569  
`\pgfpointborderrectangle`, 569  
`\pgfpointcurveatime`, 569  
`\pgfpointcylindrical`, 567  
`\pgfpointdecoratedinputsegmentlast`, 588  
`\pgfpointdecoratedpathfirst`, 591  
`\pgfpointdecoratedpathlast`, 588, 591  
`\pgfpointdecorationpathlast`, 591  
`\pgfpointdiff`, 568  
`\pgfpointintersectionofcircles`, 570  
`\pgfpointintersectionoflines`, 570  
`\pgfpointintersectionsolution`, 571  
`\pgfpointlineatdistance`, 568  
`\pgfpointlineatime`, 568  
`\pgfpointmetadecoratedpathfirst`, 593  
`\pgfpointmetadecoratedpathlast`, 593  
`\pgfpointnormalised`, 568  
`\pgfpointorigin`, 565  
`\pgfpointpolar`, 565  
`\pgfpointpolarxy`, 566  
`\pgfpointscale`, 567  
`\pgfpointshapeborder`, 615  
`\pgfpointsspherical`, 567  
`\pgfpointxy`, 565  
`\pgfpointxyz`, 566  
`\pgfqbox`, 669  
`\pgfqboxsynced`, 669  
`\pgfqkeys`, 480  
`\pgfqkeysactivatefamiliesandfilteroptions`, 497  
`\pgfqkeysactivatesinglefamilyandfilteroptions`, 497  
`\pgfqkeysalso`, 480  
`\pgfqkeysfiltered`, 494  
`\pgfqpoint`, 668  
`\pgfqpointxy`, 668  
`\pgfqpointxyz`, 668  
`\pgfrealjobname`, 643  
`pgfscope` environment, 560, 561  
`\pgfsetadditionalshadettransform`, 661  
`\pgfsetarrowoptions`, 607  
`\pgfsetarrows`, 599, 609  
`\pgfsetarrowsend`, 599, 609  
`\pgfsetarrowsstart`, 598, 608  
`\pgfsetbaseline`, 560  
`\pgfsetbaselinepointlater`, 560  
`\pgfsetbaselinepointnow`, 560  
`\pgfsetbeveljoin`, 597  
`\pgfsetbuttcap`, 597  
`\pgfsetcolor`, 598  
`\pgfsetcornersarced`, 580  
`\pgfsetdash`, 597  
`\pgfsetdecorationsegmenttransformation`, 592  
`\pgfseteorule`, 600  
`\pgfsetfading`, 663  
`\pgfsetfadingforcurrentpath`, 664  
`\pgfsetfillcolor`, 601  
`\pgfsetfillopacity`, 662  
`\pgfsetfillpattern`, 637  
`\pgfsetinnerlinewidth`, 600  
`\pgfsetinnerstrokecolor`, 600  
`\pgfsetlayers`, 653  
`\pgfsetlinetofirstplotpoint`, 652  
`\pgfsetlinewidth`, 597  
`\pgfsetmatrixcolumnsep`, 625  
`\pgfsetmatrixrowsep`, 626  
`\pgfsetmiterjoin`, 597  
`\pgfsetmiterlimit`, 597  
`\pgfsetmovetofirstplotpoint`, 652



\pgfsetnonzerorule, 601  
\pgfsetplotmarkphase, 395  
\pgfsetplotmarkrepeat, 395  
\pgfsetplotmarksizes, 396  
\pgfsetplottension, 390  
\pgfsetrectcap, 597  
\pgfsetroundcap, 597  
\pgfsetroundjoin, 597  
\pgfsetshortenend, 599  
\pgfsetshortenstart, 599  
\pgfsetstrokecolor, 598  
\pgfsetstrokeopacity, 662  
\pgfsettransform, 633  
\pgfsetxvec, 566  
\pgfsetyvec, 566  
\pgfsetzvec, 566  
\pgfshadecolorortorgb, 657  
\pgfshadepath, 658  
pgfsys package, 671  
pgfsys-common-pdf file, 671  
pgfsys-common-postscript file, 671  
pgfsys-dvi.def file, 110  
pgfsys-dvipdfm.def file, 108  
pgfsys-dvips.def file, 108  
pgfsys-pdftex.def file, 107  
pgfsys-tex4ht.def file, 109  
pgfsys-textures.def file, 108  
pgfsys-vtex.def file, 108  
pgfsys-xetex.def file, 108  
\pgfsys@begininvisible, 681  
\pgfsys@beginpicture, 672  
\pgfsys@beginpurepicture, 672  
\pgfsys@beginscope, 678  
\pgfsys@beveljoin, 676  
\pgfsys@buttcap, 675  
\pgfsys@clipnext, 675  
\pgfsys@closepath, 673  
\pgfsys@closestroke, 674  
\pgfsys@color@cmy, 677  
\pgfsys@color@cmy@fill, 677  
\pgfsys@color@cmy@stroke, 677  
\pgfsys@color@cmyk, 677  
\pgfsys@color@cmyk@fill, 677  
\pgfsys@color@cmyk@stroke, 677  
\pgfsys@color@gray, 677  
\pgfsys@color@gray@fill, 677  
\pgfsys@color@gray@stroke, 677  
\pgfsys@color@reset, 677  
\pgfsys@color@reset@inorderfalse, 678  
\pgfsys@color@reset@inordertrue, 678  
\pgfsys@color@rgb, 676  
\pgfsys@color@rgb@fill, 677  
\pgfsys@color@rgb@stroke, 676  
\pgfsys@color@unstacked, 678  
\pgfsys@curveto, 673  
\pgfsys@declarepattern, 678  
\pgfsys@defineimage, 679  
\pgfsys@definemask, 680  
\pgfsys@defobject, 681  
\pgfsys@discardpath, 675  
\pgfsys@endinvisible, 681  
\pgfsys@endpicture, 672  
\pgfsys@endpurepicture, 672  
\pgfsys@endscope, 678  
\pgfsys@fadingfrombox, 680  
\pgfsys@fill, 675  
\pgfsys@fill@opacity, 680  
\pgfsys@fill@stroke, 675  
\pgfsys@functionals shading, 680  
\pgfsys@getposition, 681  
\pgfsys@hbox, 672  
\pgfsys@hboxsynced, 672  
\pgfsys@horishading, 679  
\pgfsys@imagesuffixlist, 679  
\pgfsys@invoke, 680  
\pgfsys@lineto, 673  
\pgfsys@markposition, 681  
\pgfsys@miterjoin, 676  
\pgfsys@moveto, 673  
\pgfsys@radialshading, 679  
\pgfsys@rect, 673  
\pgfsys@rectcap, 675  
\pgfsys@roundcap, 675  
\pgfsys@roundjoin, 676  
\pgfsys@setdash, 676  
\pgfsys@setlinewidth, 675  
\pgfsys@setmiterlimit, 676  
\pgfsys@setpatterncolored, 678  
\pgfsys@setpatternuncolored, 678  
\pgfsys@stroke, 674  
\pgfsys@stroke@opacity, 680  
\pgfsys@transformcm, 674  
\pgfsys@transformshift, 674  
\pgfsys@transformxyscale, 674  
\pgfsys@transparencygroupfrombox, 680  
\pgfsys@typesetpicturebox, 672  
\pgfsys@usefading, 680  
\pgfsys@useobject, 681  
\pgfsys@vertshading, 679  
\pgfsysdriver, 671  
\pgfsysprotocol@bufferedfalse, 686  
\pgfsysprotocol@bufferedtrue, 686  
\pgfsysprotocol@flushcurrentprotocol, 686  
\pgfsysprotocol@getcurrentprotocol, 686  
\pgfsysprotocol@invokecurrentprotocol, 686  
\pgfsysprotocol@literal, 686  
\pgfsysprotocol@literalbuffered, 686  
\pgfsysprotocol@setcurrentprotocol, 686  
\pgfsyssoftpath@closepath, 684  
\pgfsyssoftpath@curveto, 684  
\pgfsyssoftpath@flushcurrentpath, 684  
\pgfsyssoftpath@getcurrentpath, 684  
\pgfsyssoftpath@invokecurrentpath, 684  
\pgfsyssoftpath@lineto, 684  
\pgfsyssoftpath@moveto, 684  
\pgfsyssoftpath@rect, 684  
\pgfsyssoftpath@setcurrentpath, 684  
\pgftext, 563  
\pgftransformarrow, 630  
\pgftransformcm, 630  
\pgftransformcurveat, 631  
\pgftransforminvert, 632  
\pgftransformlineat, 630  
\pgftransformreset, 632  
\pgftransformresetnontranslations, 632  
\pgftransformrotate, 630

- \pgftransformscale, 629
- \pgftransformshift, 628
- \pgftransformtriangle, 630
- \pgftransformxscale, 629
- \pgftransformxshift, 629
- \pgftransformxslant, 629
- \pgftransformyscale, 629
- \pgftransformyshift, 629
- \pgftransformyslant, 629
- pgftransparencygroup environment, 665
- \pgfuseimage, 639
- \pgfusepath, 596
- \pgfusepathqclip, 669
- \pgfusepathqfill, 669
- \pgfusepathqfillstroke, 669
- \pgfusepathqstroke, 669
- \pgfuseplotmark, 396
- \pgfuseshading, 658
- \pgfutil@tempboxa, 667
- \pgfutil@tempdima, 666
- \pgfutil@tempdimb, 666
- pi math function, 529
- pin key, 193
- pin distance key, 193
- pin edge key, 194
- pin position key, 193
- place key, 385
- plot module, 649
- plot path operation, 220
- Plot marks
  - \*, 397
  - l, 398
  - +, 397
  - , 398
  - asterisk, 398
  - ball, 225
  - diamond, 398
  - diamond\*, 398
  - o, 398
  - oplus, 398
  - oplus\*, 398
  - otimes, 398
  - otimes\*, 398
  - pentagon, 398
  - pentagon\*, 398
  - square, 398
  - square\*, 398
  - star, 398
  - text, 398
  - triangle, 398
  - triangle\*, 398
  - x, 397
- plohandlers library, 390
- plotmarks library, 398
- point key, 128
- point down key, 291
- point left key, 292
- point right key, 292
- point up key, 291
- polar comb key, 229
- pos key, 187
- positioning library, 182
- post key, 245, 386
- post length key, 245
- postaction key, 168
- pow math function, 527
- pre key, 244, 385
- pre and post key, 386
- pre length key, 245
- preactions key, 166
- precision key, 540
- Predefined node
  - <chain name>*-begin, 283
  - <chain name>*-end, 283
  - current bounding box, 615
  - current page, 616
  - current path bounding box, 616
  - path picture bounding box, 163
- .prefix handler, 490
- prefix key, 224, 341
- prefix after command key, 138
- .prefix code handler, 488
- .prefix style handler, 490
- print sign key, 543
- r postfix math operator, 524
- rad math function, 529
- radial shading, 401
- radius key, 124, 141, 316
- raise key, 243
- rand math function, 532
- random math function, 532
- random starburst key, 425
- random steps decoration, 317
- randomize angle percent key, 363
- randomize step percent key, 363
- raw gnuplot key, 224
- real math function, 528
- rectangle path operation, 140
- rectangle shape, 406
- rectangle callout shape, 442
- rectangle ee shape, 309
- rectangle split shape, 438
- rectangle split allocate boxes key, 438
- rectangle split draw splits key, 440
- rectangle split empty part depth key, 439
- rectangle split empty part height key, 439
- rectangle split empty part width key, 439
- rectangle split horizontal key, 439
- rectangle split ignore empty parts key, 439
- rectangle split part align key, 439
- rectangle split part fill key, 440
- rectangle split parts key, 439
- rectangle split use custom fill key, 440
- regular polygon shape, 411
- regular polygon sides key, 412
- relationship key, 337
- relative key, 452
- remake next key, 343
- remember key, 504
- remember picture key, 196
- repeat state key, 587
- reset cm key, 250
- reset marks key, 326
- resistor key, 305, 307
- resize to layout, 512
- restore key, 346

- .retry handler, 492
- reverse path key, 334
- right key, 181, 184, 334, 462, 563
- right angle key, 363
- right color key, 399
- right delimiter key, 370
- right hook arrow tip, 254
- right hook reversed arrow tip, 254
- right indent key, 335
- right to arrow tip, 254
- right to reversed arrow tip, 254
- rnd math function, 532
- root concept key, 373
- rotate key, 250, 564
- rotate around key, 250
- rotate fit key, 350
- round math function, 528
- round cap arrow tip, 254
- rounded corners key, 141
- rounded corners layout, 513
- rounded rectangle shape, 447
- rounded rectangle arc length key, 447
- rounded rectangle east arc key, 448
- rounded rectangle left arc key, 448
- rounded rectangle right arc key, 448
- rounded rectangle west arc key, 447
- row *(number)* key, 204
- row *(row number)* column *(column number)* key, 204
- row sep key, 202
- rt key, 462
- \rule, 364
- rule set key, 365
  
- samples key, 222, 469
- samples at key, 222
- Saturday date test, 506
- \savedanchor, 618
- \saveddimen, 618
- \savedmacro, 619
- saw decoration, 318
- scale key, 248
- scale around key, 249
- scale file plot x key, 353, 355
- scale file plot y key, 353, 355
- scale file plot z key, 353, 355
- scale results key, 352, 355
- Schottky diode key, 308
- sci key, 539
- sci 10<sup>e</sup> key, 543
- sci 10e key, 543
- sci E key, 543
- sci e key, 543
- sci subscript key, 543
- sci superscript key, 543
- sci zerofill key, 540
- scope environment, 118
- scope fading key, 237
- scopes library, 118
- .search also handler, 485
- sec math function, 529
- segment length key, 316
- semicircle shape, 411
- semithick key, 155
- semitransparent key, 232

- separator key, 468
- sequence number key, 325
- serif cm arrow tip, 254
- set decimal separator key, 541
- set thousands separator key, 541
- \shade, 153
- shade key, 163
- \shadedraw, 153
- shading key, 164
- shading angle key, 164
- Shadings
  - axis, 399
  - ball, 399
  - bilinear interpolation, 400
  - color wheel, 400
  - color wheel black center, 401
  - color wheel white center, 401
  - Mandelbrot set, 401
  - radial, 401
- shadings library, 399
- shadow scale key, 402
- shadow xshift key, 402
- shadow yshift key, 403
- shadows library, 402
- shape key, 171, 331
- shape aspect key, 174
- shape backgrounds decoration, 330
- shape border rotate key, 175
- shape border uses incircle key, 175
- shape end height key, 333
- shape end size key, 333
- shape end width key, 332
- shape evenly spread key, 331
- shape height key, 329
- shape scaled key, 332
- shape sep key, 331
- shape size key, 329
- shape sloped key, 331
- shape start height key, 332
- shape start size key, 332
- shape start width key, 332
- shape width key, 329
- Shapes
  - arrow box, 432
  - battery IEC, 314
  - break contact IEC, 315
  - breakdown diode IEC, 312
  - capacitor IEC, 313
  - chamfered rectangle, 448
  - circle, 406
  - circle ee, 309
  - circle solidus, 436
  - circle split, 435
  - circular sector, 419
  - cloud, 423
  - cloud callout, 444
  - cross out, 446
  - cylinder, 420
  - dart, 417
  - diamond, 407
  - direction ee, 309
  - double arrow, 431
  - ellipse, 408

- ellipse callout, 443
- ellipse split, 437
- forbidden sign, 422
- generic circle IEC, 310
- generic diode IEC, 311
- ground IEC, 314
- inductor IEC, 313
- isosceles triangle, 415
- kite, 416
- make contact IEC, 314
- nand gate IEC, 303
- nand gate US, 301
- rectangle, 406
- rectangle callout, 442
- rectangle ee, 309
- rectangle split, 438
- regular polygon, 411
- rounded rectangle, 447
- semicircle, 411
- signal, 426
- single arrow, 429
- star, 413
- starburst, 425
- strike out, 447
- tape, 427
- trapezium, 409
- var make contact IEC, 314
- var resistor IEC, 312
- shapes module, 610
- shapes.arrows library, 429
- shapes.callout library, 441
- shapes.gates.ee library, 308
- shapes.gates.ee.IEC library, 310
- shapes.gates.logic library, 299
- shapes.gates.logic.IEC library, 302
- shapes.gates.logic.US library, 300
- shapes.geometric library, 407
- shapes.misc library, 445
- shapes.multipart library, 435
- shapes.symbols library, 422
- sharp corners key, 141
- sharp plot key, 226
- shift key, 248
- shift only key, 248
- shorten < key, 159
- shorten > key, 158
- show background bottom key, 262
- show background grid key, 261
- show background left key, 262
- show background rectangle key, 260
- show background right key, 262
- show background top key, 261
- .show code handler, 492
- show path construction decoration, 321
- .show value handler, 492
- showpos key, 543
- sibling angle key, 459
- sibling distance key, 215
- siemens key, 308
- signal class, 551
- signal method, 551
- signal shape, 426
- signal from key, 427
- signal pointer angle key, 427
- signal to key, 427
- sin math function, 529
- sin path operation, 146
- single arrow shape, 429
- single arrow head extend key, 430
- single arrow head indent key, 430
- single arrow tip angle key, 430
- sinh math function, 533
- sixpointed stars pattern, 384
- skip 0. key, 542
- sloped key, 189
- small circuit symbols key, 289
- smooth key, 226
- smooth cycle key, 227
- snake decoration, 319
- solid key, 156
- solution key, 128
- sort by key, 131
- source key, 470
- south fading, 348
- space arrow tip, 254
- sqrt math function, 526
- square arrow tip, 254
- square plot mark, 398
- square\* plot mark, 398
- star plot mark, 398
- star shape, 413
- star point height key, 414
- star point ratio key, 414
- star points key, 414
- starburst shape, 425
- starburst point height key, 425
- starburst points key, 425
- start angle key, 143
- start branch key, 284
- start chain key, 280
- start radius key, 316
- \state, 585, 593
- state key, 256
- state with output key, 256
- state without output key, 256
- std key, 540
- stealth arrow tip, 253, 609
- stealth reversed arrow tip, 253, 609
- stealth' arrow tip, 253
- stealth' reversed arrow tip, 253
- step key, 144, 363, 578
- stepx key, 578
- stepy key, 578
- .store in handler, 490
- straight zigzag decoration, 317
- stride length key, 328
- strike out shape, 447
- structured tokens key, 387
- .style handler, 489
- style key, 398
- .style 2 args handler, 489
- .style args handler, 489
- Styles for graphics, *see* Graphic options and styles
- subtract math function, 526
- Sunday date test, 506
- svg path operation, 147

- svg.path library, 451
- swap key, 188
- switch if input segment less than key, 586
- switch if less than key, 586, 593
- \symbol, 362
- system call key, 340
  
- table format, 467
- tan math function, 529
- tangent coordinate system, 128
- tanh math function, 533
- tape shape, 427
- tape bend bottom key, 428
- tape bend height key, 428
- tape bend top key, 428
- tension key, 227
- TeX code format, 468
- text key, 176, 333
- text plot mark, 398
- text align key, 334
- text along path decoration, 333
- text color key, 334
- text depth key, 180
- text format delimiters key, 334
- text height key, 180
- text mark key, 398
- text opacity key, 233
- text width key, 177
- thick key, 155
- thin key, 155
- through library, 457
- Thursday date test, 506
- ticks decoration, 321
- tight background key, 260
- \tikz, 117
- /tikz/
  - >, 158
  - above, 181, 182
  - above delimiter, 370
  - above left, 181, 184, 185
  - above right, 182, 185
  - absolute, 191
  - accepting, 257
  - accepting above, 258
  - accepting below, 258
  - accepting by arrow, 257
  - accepting by double, 257
  - accepting left, 258
  - accepting right, 258
  - accepting text, 257
  - accepting where, 257
  - alias, 170
  - align, 177
  - allow upside down, 189
  - ampersand replacement, 206
  - anchor, 126, 181, 205
  - and gate, 298
  - annotation, 379
  - annotation arrow, 293, 307
  - append after command, 138
  - arrows, 157
  - at, 142, 171
  - at end, 190
  - at start, 190
  - attribute, 338
  - auto, 188
  - background grid, 261
  - background rectangle, 260
  - background top, 262
  - ball color, 400
  - base left, 186
  - base right, 186
  - baseline, 116
  - below, 181, 184
  - below delimiter, 370
  - below left, 182, 185
  - below right, 182
  - bend, 145
  - bend angle, 454
  - bend at end, 146
  - bend at start, 146
  - bend left, 453
  - bend pos, 145
  - bend right, 454
  - bottom color, 399
  - callout absolute pointer, 442
  - callout relative pointer, 442
  - cells, 203
  - chain default direction, 280
  - child anchor, 218
  - children are tokens, 386
  - circle connection bar, 377
  - circle connection bar switch color, 377
  - circle through, 457
  - circuit declare annotation, 293
  - circuit declare symbol, 289
  - circuit declare unit, 293
  - circuit ee, 304
  - circuit ee IEC, 305
  - circuit handle symbol, 290
  - circuit logic, 296
  - circuit logic CDH, 298
  - circuit logic IEC, 296
  - circuit logic US, 297
  - circuit symbol filled, 295
  - circuit symbol lines, 295
  - circuit symbol open, 295
  - circuit symbol size, 289
  - circuit symbol unit, 289
  - circuits, 289
  - circular drop shadow, 404
  - circular glow, 405
  - clip, 165
  - clockwise from, 459
  - cm, 250
  - color, 154
  - colored tokens, 387
  - column *<number>*, 203
  - column sep, 201
  - concept, 372
  - concept color, 373, 374
  - concept connection, 375
  - const plot, 227
  - const plot mark left, 227
  - const plot mark right, 227
  - continue branch, 285
  - continue chain, 281

controls, 455  
 copy shadow, 403  
 counterclockwise from, 459  
 cs/  
   angle, 124, 127  
   horizontal line through, 129  
   name, 126  
   node, 128  
   point, 128  
   radius, 124  
   solution, 128  
   vertical line through, 130  
   x, 123  
   x radius, 124, 125  
   y, 123  
   y radius, 124, 125  
   z, 123  
 current point is local, 132  
 curve to, 452  
 dash pattern, 156  
 dash phase, 156  
 dashed, 157  
 dates, 263  
 day code, 265  
 day list downward, 271  
 day list left, 272  
 day list right, 272  
 day list upward, 271  
 day text, 266  
 day xshift, 264  
 day yshift, 264  
 decorate, 243  
 delta angle, 143  
 densely dashed, 157  
 densely dotted, 157  
 distance, 454  
 domain, 222  
 dotted, 157  
 double, 159  
 double copy shadow, 404  
 double distance, 159  
 double distance between line centers, 159  
 double equal sign distance, 159  
 draw, 154  
 draw opacity, 231  
 drop shadow, 403  
 edge from parent, 219  
 edge from parent fork down, 460  
 edge from parent fork left, 460  
 edge from parent fork right, 460  
 edge from parent fork up, 460  
 edge from parent path, 218  
 end angle, 143  
 entity, 337  
 even odd rule, 162  
 every *<part name>* node part, 176  
 every *<shape>* node, 172  
 every above delimiter, 370  
 every accepting by arrow, 258  
 every annotation, 379  
 every attribute, 338  
 every below delimiter, 370  
 every calendar, 263  
 every cell, 203  
 every child, 213  
 every child node, 213  
 every circle, 142  
 every circle connection bar, 377  
 every circuit ee, 304  
 every circuit logic, 296  
 every circuit symbol, 290  
 every concept, 372  
 every cut, 380  
 every day (initially anchor), 266  
 every delimiter, 369  
 every edge (initially draw), 195  
 every entity, 337  
 every even column, 203  
 every even row, 204  
 every extra concept, 373  
 every fit, 349  
 every fold, 380  
 every info, 292  
 every initial by arrow, 257  
 every join, 284  
 every label, 193  
 every left delimiter, 369  
 every loop, 456  
 every mark, 226  
 every matrix, 199  
 every mindmap, 371  
 every month, 267  
 every node, 171  
 every odd column, 203  
 every odd row, 204  
 every on chain, 282  
 every path, 138  
 every picture, 117  
 every pin, 193  
 every pin edge, 193  
 every place, 385  
 every plot, 225  
 every relationship, 338  
 every right delimiter, 370  
 every scope, 118  
 every shadow, 403  
 every state, 256  
 every to, 148, 149  
 every token, 386  
 every transition, 385  
 every year, 268  
 execute after day scope, 269  
 execute at begin cell, 204  
 execute at begin day scope, 269  
 execute at begin picture, 116  
 execute at begin scope, 118  
 execute at begin to, 149  
 execute at empty cell, 204  
 execute at end cell, 204  
 execute at end day scope, 269  
 execute at end picture, 116  
 execute at end scope, 118  
 execute before day scope, 269  
 executed at end to, 149  
 external/  
   export, 343

- export next, 343
- figure list, 343
- figure name, 342
- force remake, 343
- mode, 344
- only named, 346
- optimize, 345
- optimize command away, 345
- prefix, 341
- remake next, 343
- system call, 340
- verbose IO, 344
- extra concept, 373
- face 1, 380
- face 12, 380
- face 2, 380
- face 3, 380
- fading angle, 236
- fading transform, 235
- fill, 160
- fill opacity, 232
- fit, 349
- fit fading, 235
- folding line length, 380
- font, 176
- framed, 261
- general shadow, 402
- gridded, 261
- grow, 215
- grow cyclic, 459
- grow via three points, 458
- grow', 216
- growth function, 217
- growth parent anchor, 217
- help lines, 145
- huge circuit symbols, 289
- huge mindmap, 372
- id, 224
- if, 268
- in, 452
- in control, 455
- in distance, 455
- in looseness, 454
- in max distance, 454
- in min distance, 454
- info, 292
- info sloped, 292
- info', 292
- info' sloped, 293
- initial, 256
- initial above, 257
- initial below, 257
- initial by arrow, 257
- initial by diamond, 257
- initial left, 257
- initial right, 257
- initial text, 257
- initial where, 257
- inner color, 401
- inner frame sep, 260
- inner frame xsep, 260
- inner frame ysep, 260
- inputs, 296, 298
- insert path, 138
- intersection/
  - by, 131
  - name, 131
  - of, 130
  - sort by, 131
  - total, 131
- intial distance, 257, 258
- join, 284
- jump mark left, 228
- jump mark right, 228
- key attribute, 338
- label, 191
- label distance, 193
- label position, 191
- large circuit symbols, 289
- large mindmap, 372
- late options, 198
- left, 181, 184
- left color, 399
- left delimiter, 369
- level, 213
- level 1 concept, 373
- level 2 concept, 374
- level 3 concept, 374
- level 4 concept, 374
- level *(number)*, 213
- level distance, 214
- light emitting, 306
- line cap, 155
- line join, 156
- line to, 452
- line width, 155
- loop, 455
- loop above, 455
- loop below, 455
- loop left, 455
- loop right, 455
- loose background, 260
- loosely dashed, 157
- loosely dotted, 157
- looseness, 454
- lower left, 400
- mark, 225
- mark indices, 225
- mark options, 226
- mark phase, 225
- mark repeat, 225
- mark size, 226
- matrix, 199
- matrix anchor, 205
- matrix of math nodes, 368
- matrix of nodes, 367
- max distance, 454
- medium circuit symbols, 289
- mid left, 186
- mid right, 186
- middle color, 399
- midway, 190
- min distance, 454
- mindmap, 371
- missing, 217
- miter limit, 156

month code, 267  
 month label above centered, 275  
 month label above left, 274  
 month label above right, 275  
 month label below centered, 276  
 month label below left, 275  
 month label left, 273  
 month label left vertical, 274  
 month label right, 274  
 month label right vertical, 274  
 month list, 273  
 month text, 267  
 month xshift, 264  
 month yshift, 264  
 move to, 452  
 name, 170, 234  
 name intersections, 130  
 name path, 130  
 near end, 190  
 near start, 190  
 nearly opaque, 232  
 nearly transparent, 232  
 node distance, 184  
 node halign header, 179  
 nodes, 203  
 nodes in empty cells, 368  
 nonzero rule, 161  
 ohm, 306  
 on chain, 281  
 on grid, 183  
 only marks, 230  
 opacity, 231  
 opaque, 232  
 out, 452  
 out control, 455  
 out distance, 455  
 out looseness, 454  
 out max distance, 454  
 out min distance, 454  
 outer color, 401  
 outer frame sep, 261  
 outer frame xsep, 261  
 outer frame ysep, 261  
 overlay, 196  
 parabola height, 146  
 parametric, 224  
 parent anchor, 218  
 path fading, 235  
 path picture, 162  
 pattern, 160  
 pattern color, 161  
 pin, 193  
 pin distance, 193  
 pin edge, 194  
 pin position, 193  
 place, 385  
 point down, 291  
 point left, 292  
 point right, 292  
 point up, 291  
 polar comb, 229  
 pos, 187  
 post, 386  
 postaction, 168  
 pre, 385  
 pre and post, 386  
 preactions, 166  
 prefix, 224  
 prefix after command, 138  
 radius, 141  
 raw gnuplot, 224  
 relationship, 337  
 relative, 452  
 remember picture, 196  
 reset cm, 250  
 resistor, 305  
 right, 181, 184  
 right color, 399  
 right delimiter, 370  
 root concept, 373  
 rotate, 250  
 rotate around, 250  
 rotate fit, 350  
 rounded corners, 141  
 row *(number)*, 204  
 row *(row number)* column *(column number)*,  
 204  
 row sep, 202  
 samples, 222  
 samples at, 222  
 scale, 248  
 scale around, 249  
 scope fading, 237  
 semithick, 155  
 semitransparent, 232  
 shade, 163  
 shading, 164  
 shading angle, 164  
 shadow scale, 402  
 shadow xshift, 402  
 shadow yshift, 403  
 shape, 171  
 sharp corners, 141  
 sharp plot, 226  
 shift, 248  
 shift only, 248  
 shorten <, 159  
 shorten >, 158  
 show background bottom, 262  
 show background grid, 261  
 show background left, 262  
 show background rectangle, 260  
 show background right, 262  
 show background top, 261  
 sibling angle, 459  
 sibling distance, 215  
 sloped, 189  
 small circuit symbols, 289  
 smooth, 226  
 smooth cycle, 227  
 solid, 156  
 start angle, 143  
 start branch, 284  
 start chain, 280  
 state, 256  
 state with output, 256



- state without output, 256
- step, 144
- structured tokens, 387
- swap, 188
- tension, 227
- tex4ht node/
  - class, 110
  - css, 110
  - escape, 109
  - id, 110
- text, 176
- text depth, 180
- text height, 180
- text opacity, 233
- text width, 177
- thick, 155
- thin, 155
- tight background, 260
- tiny circuit symbols, 289
- to path, 148
- token, 386
- token distance, 387
- tokens, 387
- top color, 399
- transform canvas, 250
- transform shape, 187
- transition, 385
- transparency group, 238
- transparent, 231
- turtle/
  - back, 461
  - bk, 461
  - distance, 461
  - fd, 461
  - forward, 461
  - home, 461
  - how, 461
  - left, 462
  - lt, 462
  - right, 462
  - rt, 462
- turtle, 461
- ultra nearly opaque, 232
- ultra nearly transparent, 231
- ultra thick, 155
- ultra thin, 155
- upper left, 400
- upper right, 400
- use as bounding box, 164
- variable, 222
- very near end, 190
- very near start, 190
- very nearly opaque, 232
- very nearly transparent, 232
- very thick, 155
- very thin, 155
- week list, 272
- x, 246
- x radius, 141
- xbar, 229
- xbar interval, 230
- xcomb, 228
- xscale, 249
- xshift, 248
- xslant, 249
- xstep, 144
- y, 247
- y radius, 141
- ybar, 229
- ybar interval, 229
- ycomb, 228
- year code, 267
- year text, 268
- yscale, 249
- yshift, 248
- yslant, 249
- ystep, 144
- z, 247
- tikz/
  - adjustable, 308
  - ampere, 308
  - and gate, 299
  - backward diode, 308
  - battery, 307
  - break contact, 308
  - breakdown diode, 308
  - buffer gate, 299
  - bulb, 307
  - capacitor, 307
  - contact, 308
  - coulomb, 308
  - current direction, 307
  - current direction', 307
  - current source, 307
  - diode, 308
  - direction info, 308
  - farad, 308
  - ground, 307
  - henry, 308
  - hertz, 308
  - inductor, 307
  - light dependent, 308
  - light emitting, 308
  - make contact, 308
  - nand gate, 299
  - nor gate, 299
  - not gate, 299
  - ohm, 308
  - or gate, 299
  - resistor, 307
  - Schottky diode, 308
  - siemens, 308
  - tunnel diode, 308
  - volt, 308
  - voltage source, 307
  - voltampere, 308
  - watt, 308
  - xnor gate, 299
  - xor gate, 299
  - Zener diode, 308
- tikz package, 115
- \tikzaliascoordinatesystem, 129
- \tikzdeclarecoordinatesystem, 129
- \tikzexternalize, 340
- \tikzfading, 234
- tikzfadingfrompicture environment, 233, 234

- \tikzfoldingdodecahedron, 380
- \tikzinputsegmentfirst, 322
- \tikzinputsegmentlast, 322
- \tikzinputsegmentsoff, 322
- \tikzinputsegmentsoffb, 322
- \tikzlastnode, 198
- tikzpicture environment, 115, 117
- \tikzset, 119
- \tikzsetexternalprefix, 341
- \tikzsetnextfilename, 341
- tiny circuit symbols key, 289
- to arrow tip, 253, 609
- to path operation, 147
- to path key, 148
- to reversed arrow tip, 253, 609
- token key, 386
- token distance key, 387
- tokens key, 387
- top color key, 399
- topaths library, 452
- total key, 131
- transform key, 244
- transform canvas key, 250
- transform shape key, 187
- transition key, 385
- transparency group key, 238
- transparent key, 231
- trapezium shape, 409
- trapezium angle key, 409
- trapezium left angle key, 409
- trapezium right angle key, 409
- trapezium stretches key, 410
- trapezium stretches body key, 410
- trees library, 458
- triangle plot mark, 398
- triangle 45 arrow tip, 253
- triangle 45 reversed arrow tip, 253
- triangle 60 arrow tip, 253
- triangle 60 reversed arrow tip, 253
- triangle 90 arrow tip, 253
- triangle 90 cap arrow tip, 254
- triangle 90 cap reversed arrow tip, 254
- triangle 90 reversed arrow tip, 253
- triangle\* plot mark, 398
- triangles decoration, 330
- true key, 498
- true math function, 531
- .try handler, 492
- Tuesday date test, 506
- tunnel diode key, 308
- turtle key, 461
- turtle library, 461
- two screens with lagging second layout, 514
- two screens with optional second layout, 514
- ultra nearly opaque key, 232
- ultra nearly transparent key, 231
- ultra thick key, 155
- ultra thin key, 155
- unknown choice value key, 493
- unknown key key, 493
- upper left key, 400
- upper right key, 400
- use as bounding box key, 164

- use comma key, 542
- use period key, 542
- \useasboundingbox, 153
- \usepgflibrary, 558
- \usetikzlibrary, 115
- /utils/
  - exec, 493
- \value, 469
- .value forbidden handler, 487
- value forbidden key, 493
- .value required handler, 487
- value required key, 493
- var key, 503
- var make contact IEC shape, 314
- var resistor IEC shape, 312
- variable key, 222
- veclen math function, 533
- verbose IO key, 344
- version=*<version>* package option, 557
- vertical line through key, 130
- vertical lines pattern, 384
- very near end key, 190
- very near start key, 190
- very nearly opaque key, 232
- very nearly transparent key, 232
- very thick key, 155
- very thin key, 155
- volt key, 308
- voltage source key, 307
- voltampere key, 308
- \w@pgf@writea, 666
- watt key, 308
- waves decoration, 321
- Wednesday date test, 506
- week list key, 272
- weekend date test, 506
- west fading, 348
- width key, 586, 593
- width math function, 534
- workday date test, 506
- \x, 150
- x key, 123, 246, 564
- x plot mark, 397
- x radius key, 124, 125, 141
- xbar key, 229
- xbar interval key, 230
- xcomb key, 228
- xnor gate key, 299
- xnor gate IEC symbol key, 302
- xor gate key, 299
- xor gate IEC symbol key, 302
- xscale key, 249
- xshift key, 248
- xslant key, 249
- xstep key, 144
- xy polar coordinate system, 125
- xyz coordinate system, 123
- xyz polar coordinate system, 124
- \y, 150
- y key, 123, 247, 564

y radius key, 124, 125, 141  
ybar key, 229  
ybar interval key, 229  
ycomb key, 228  
year code key, 267  
year text key, 268  
yscale key, 249  
yshift key, 248  
yslant key, 249  
ystep key, 144

z key, 123, 247  
Zener diode key, 308  
zerofill key, 540  
zigzag decoration, 318